

WL series / VZ series

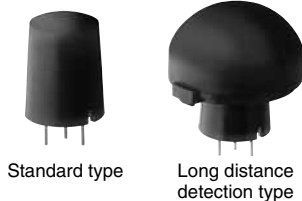

NaPiOn series

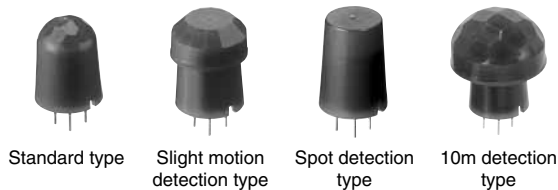

RoHS compliant

ADVANTAGES

- Simplified circuitry with fully integrated circuit design
- 1 μ A low current consumption with the proprietary design
- Excellent resistance to electromagnetic noise
- High Signal/Noise ratio to minimize false operation
- Environment-friendliness with "Lead-free" element

TYPICAL APPLICATIONS

- Lighting: lamp, automatic switch, street lighting
- Anti-crime devices: security camera, crime-prevention sensor
- Home appliance: air conditioner, air purifier, fan heater
- Commercial equipments: vending machine, copy machine
- Audio and Visual devices: TV, PC, display

FEATURES

1. Sensing circuits enclosed in a TO5 can

The high-density embedded circuit design eliminates external sensing circuits. Advantages include reduced development and design schedules.

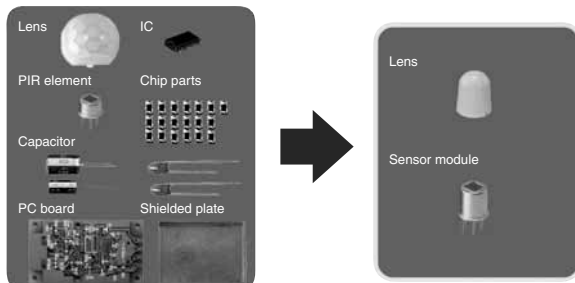

2. Super low current consumption

Reduction of current consumption allows battery life to be extended for battery driven products, including wireless based and low power consumption devices.

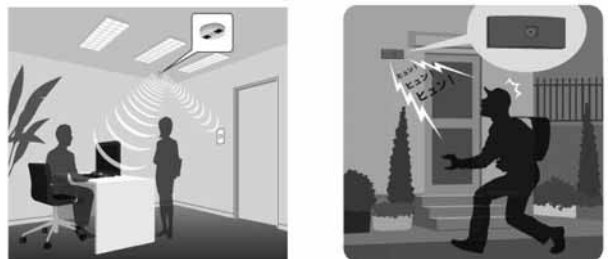

3. Excellent noise resistance

(Radiations noise, power supply noise)

The entire circuitry is enclosed in a metal package, which means it has high electromagnetic shielding capability.

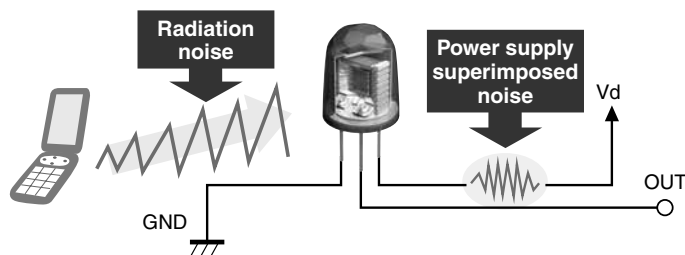

4. Miniaturized lenses with small elements

A short focal length is all that's required even when detecting at the same distance, which means both downsizing and high-sensitivity are achieved.

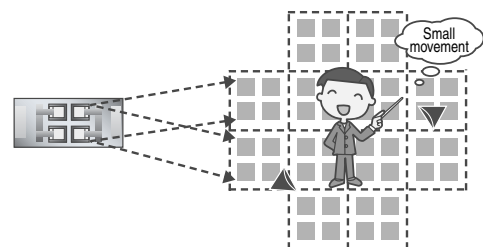

PIR Motion Sensor (EKMB, EKMC, AMN2, 3)

PRODUCT TYPES

1. WL series

Detection performance	Lens color	Consumption current		
		1 μ A	2 μ A	6 μ A
Standard type	White	EKMB1101111	EKMB1201111	EKMB1301111K
	Black	EKMB1101112	EKMB1201112	EKMB1301112K
	Pearl White	EKMB1101113	EKMB1201113	EKMB1301113K
Long distance detection type	White	EKMB1103111	EKMB1203111	EKMB1303111K
	Black	EKMB1103112	EKMB1203112	EKMB1303112K
	Pearl White	EKMB1103113	EKMB1203113	EKMB1303113K

2. VZ series

Detection performance	Lens color	Consumption current 170 μ A	
		Standard type	Long distance detection type
Standard type	White	EKMC1601111	
	Black	EKMC1601112	
	Pearl White	EKMC1601113	
Long distance detection type	White	EKMC1603111	
	Black	EKMC1603112	
	Pearl White	EKMC1603113	

3. NaPiOn series

Detection performance	Lens color	Digital output	Analog output
		Standard type	Long distance detection type
Standard type	Black	AMN31111	AMN21111
	White	AMN31112	AMN21112
Slight motion detection type	Black	AMN32111	AMN22111
	White	AMN32112	AMN22112
Spot detection type	Black	AMN33111	AMN23111
	White	AMN33112	AMN23112
10m detection type	Black	AMN34111	AMN24111
	White	AMN34112	AMN24112

RATING

1. Absolute maximum rating (Measuring condition: ambient temperature = 25°C 77°F)

Power supply voltage	-0.3 to 7.0VDC (for VZ series, NaPiOn series), -0.3 to 4.5VDC (for WL series)
Usage ambient temperature	-20 to 60°C -3 to 140°F (No freezing and condensing at low temperature)
Storage temperature	-20 to 70°C -4 to 158°F

2. Electrical characteristics

1) WL series VZ series

Items	Symbol	WL series			VZ series	Measuring conditions
		1 μ A ave.	2 μ A ave.	6 μ A ave.	170 μ A ave.	
Rated consumption current (Stand by) Note)	I _w					Ambient temperature = 25°C 77°F I _{out} = 0 Operating voltage 5V (VZ) 3V (WL)
Rated operating voltage	V _{dd}	2.3VDC min. 4.0VDC max.			3.0VDC min. 6.0VDC max.	
Output current (When detecting)	I _{out}	100 μ A max.			100 μ A max.	Ambient temperature = 25°C 77°F V _{out} \geq V _{dd} -0.5V Operating voltage 5V (VZ) 3V (WL)
Output voltage (When detecting)	V _{out}	V _{dd} -0.5VDC min.			V _{dd} -0.5VDC min.	Ambient temperature = 25°C 77°F Open when not detecting Operating voltage 5V (VZ) 3V (WL)
Circuit stability time	T _{wu}	25s typ. 210s max.		10s max.	30s max.	Ambient temperature = 25°C 77°F I _{out} = 0 Operating voltage 5V (VZ) 3V (WL) T _s [°C] = Const. (WL)

Note: The current which is consumed during detection consist of the standby consumed current plus the output current.

PIR Motion Sensor (EKMB, EKMC, AMN2, 3)

2) NaPiOn series

a) Digital output

Items	Symbol	Specified value	Measuring conditions
Rated consumption current (Stand by) (Note)	I _w	170μA ave.	Ambient temperature = 25°C 77°F Operating voltage = 5V I _{out} = 0
Rated operating voltage	V _{dd}	3.0VDC min. 6.0VDC max.	
Output current (When detecting)	I _{out}	100μA	Ambient temperature = 25°C 77°F Operating voltage = 5V V _{out} ≥ V _{dd} -0.5V
Output voltage (When detecting)	V _{out}	V _{dd} -0.5V	Ambient temperature = 25°C 77°F Operating voltage = 5V Open when not detecting
Circuit stability time	T _{wu}	30s max.	Ambient temperature = 25°C 77°F Operating voltage = 5V

Note: The current which is consumed during detection consists of the standby consumed current plus the output current.

b) Analog output

Items	Symbol	Specified value	Measuring conditions
Consumption current	I _w	170μA ave.	Ambient temperature = 25°C 77°F Operating voltage = 5V I _{out} = 0
Operating voltage	V _{dd}	4.5VDC min. 5.5VDC max.	
Output current	I _{out}	50μA	Ambient temperature = 25°C 77°F Operating voltage = 5V
Output voltage range	V _{out}	0V min. V _{DD} max.	Ambient temperature = 25°C 77°F Operating voltage = 5V
Output offset average voltage	V _{off}	2.3V min. 2.5V ave. 2.7V max.	Ambient temperature = 25°C 77°F Operating voltage = 5V Steady-state output voltage when not detecting
Steady-state noise	V _n	155mVpp ave. 300mVpp max.	Ambient temperature = 25°C 77°F Operating voltage = 5V
Detection sensitivity	V _h or V _l	0.45V	Ambient temperature = 25°C 77°F Operating voltage = 5V Temperature difference with background: 4°C 39.2°F
Circuit stability time	T _{wu}	45s	Ambient temperature = 25°C 77°F Operating voltage = 5V

Note: To set the same detection performance as the digital output type, set the output voltage (2.5V) ±0.45V.

3. Detection performance

1) WL series VZ series

Items	Standard type	Long distance detection type	Measuring conditions
Detection distance	5m 16.404ft	12m 39.3696ft	1. Detectable difference in temperature between the target and background is more than 4°C 7.2°F. 2. Movement speed 1.0m/s 3. Detection object: human body (size is 700mm × 250mm 27.559inch × 9.843inch)
Detection range (Horizontal × Vertical)	94° × 82°	102° × 92°	
Detection zone	64 zones	92 zones	

2) NaPiOn series

Items	Standard type	Slight motion detection type	Spot detection type	10m detection type	Measuring conditions
Detection distance	5m 16.404ft	2m 6.562ft	5m 16.404ft	10m 32.808ft	1. Detectable difference in temperature between the target and background is more than 4°C 7.2°F. 2. Movement speed 1) Digital output type Standard type/Spot type/10m detection type: 0.8 to 1.2m/s Slight motion detection type: 0.5m/s 2) Analog output type Standard type/Spot type/10m detection type: 0.5 to 1.5m/s Slight motion detection type: 0.3 to 1.0m/s 3. Detection object: human body (size is 700mm × 250mm 27.559inch × 9.843inch) (for the slight motion detection type, 200mm × 200mm 7.874inch × 7.874inch)
Detection range (Horizontal × Vertical)	100° × 82°	91° × 91°	38° × 22°	110° × 93°	
Detection zone	64 zones	104 zones	24 zones	80 zones	

PIR Motion Sensor (EKMB, EKMC, AMN2, 3)

DETECTION PERFORMANCE

1. WLseries VZ series Standard type

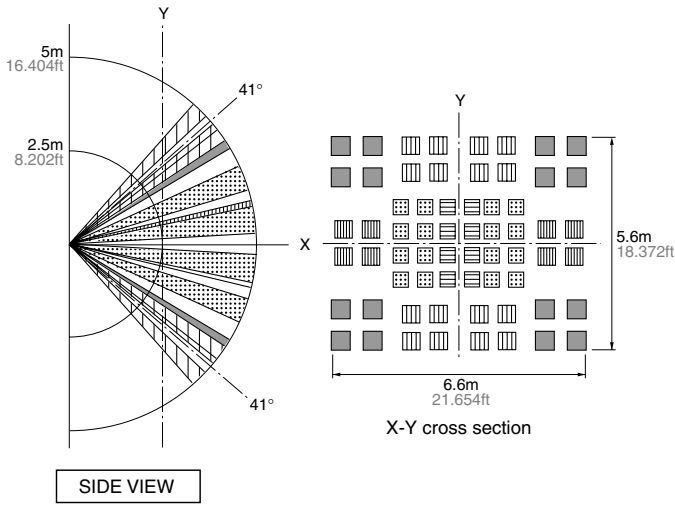

2. WL series VZ series Long distance 12m detection type

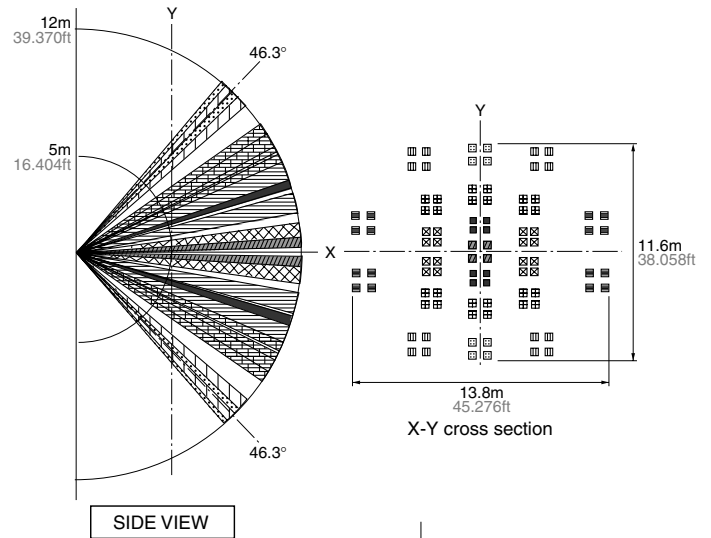

3. NaPiOn series Standard type

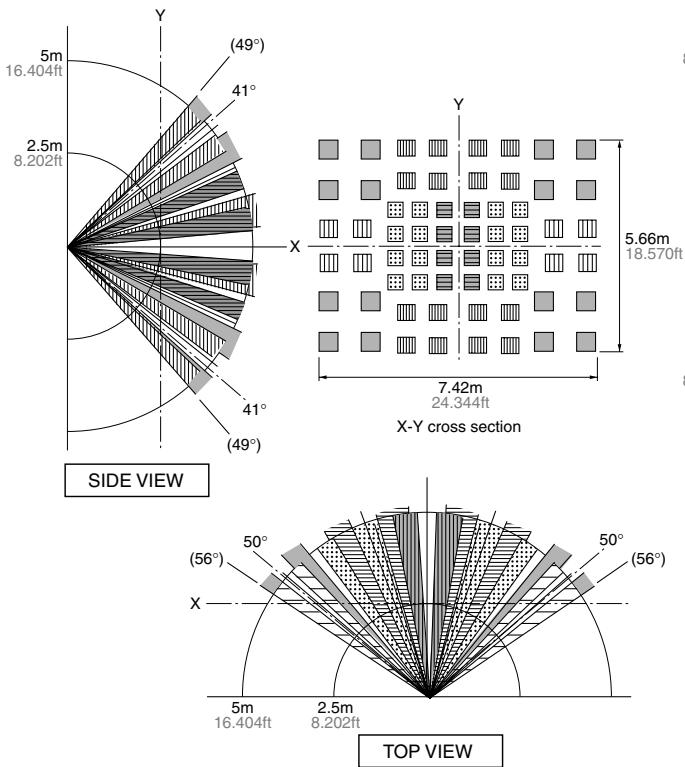

4. NaPiOn series Slight motion detection type

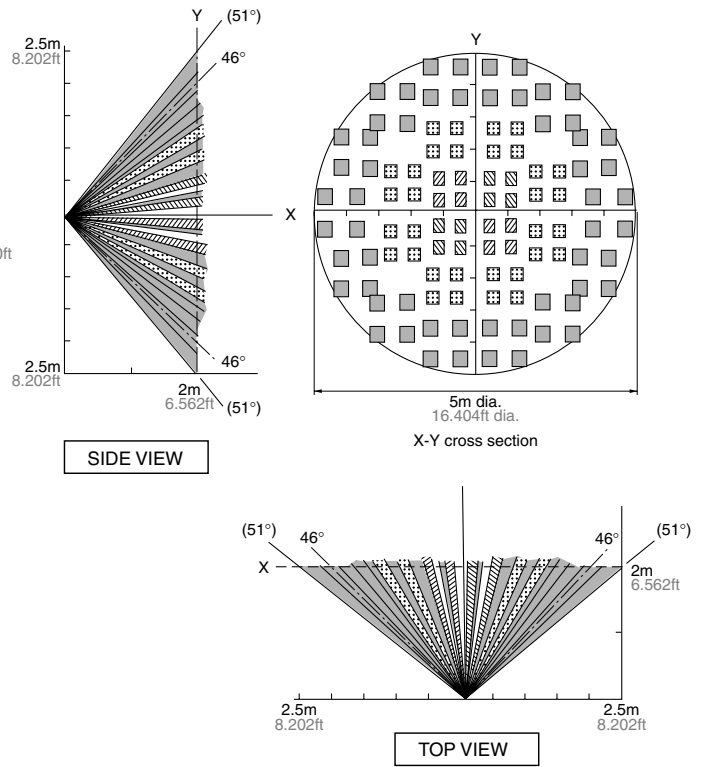

PIR Motion Sensor (EKMB, EKMC, AMN2, 3)

5. NaPiOn series Spot detection type

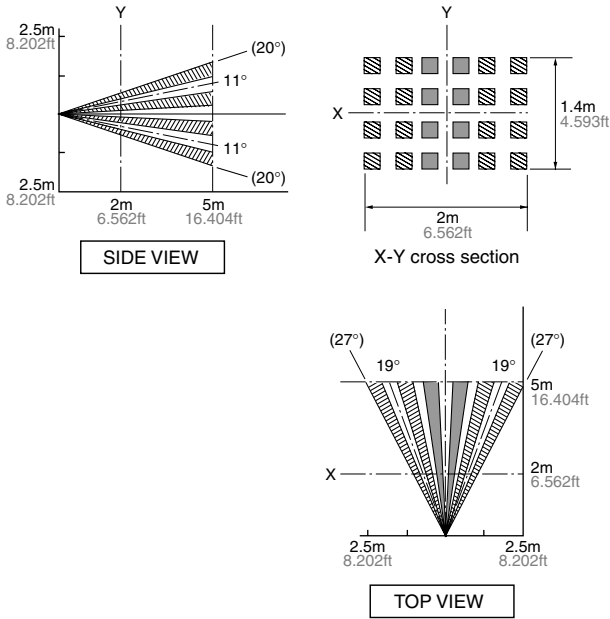

6. NaPiOn series 10m detection type

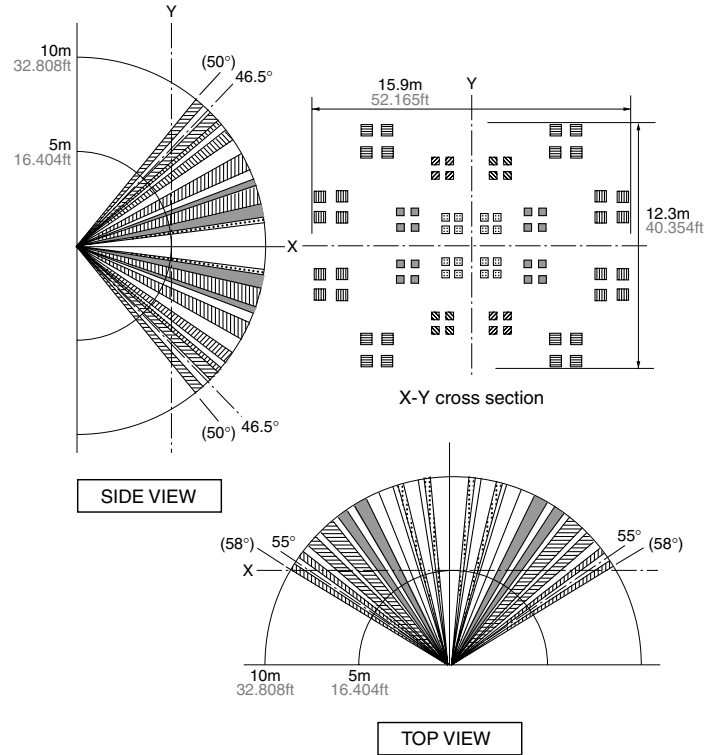

DIMENSIONS (mm inch)

The CAD data of the products with a **CAD Data** mark can be downloaded from: <http://industrial.panasonic.com/ac/e/>

1. VZ series WL series Standard type

CAD Data

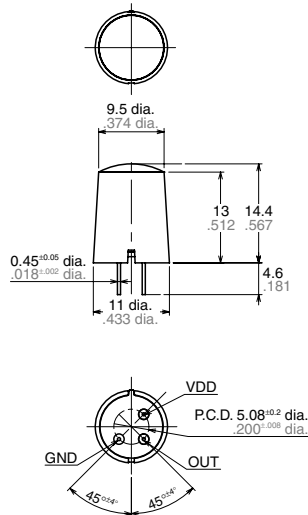

General tolerance $\pm 0.5 \pm .020$

2. VZ series WL series Long distance detection type

CAD Data

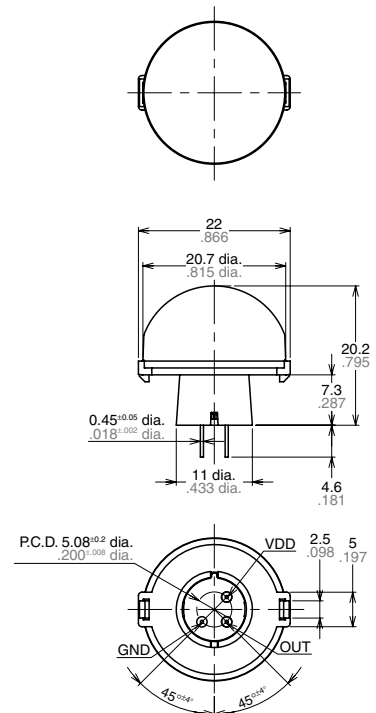

General tolerance $\pm 0.5 \pm .020$

PIR Motion Sensor (EKMB, EKMC, AMN2, 3)

3. NaPiOn series Standard type

CAD Data

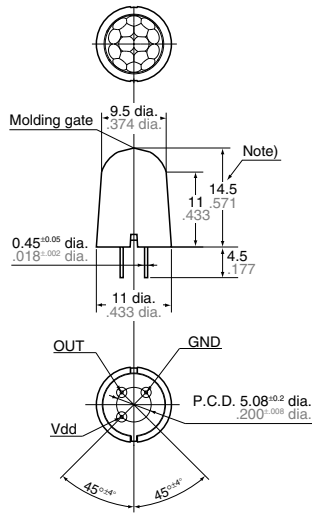

General tolerance $\pm 0.5 \pm 0.20$

4. NaPiOn series Slight motion detection type

CAD Data

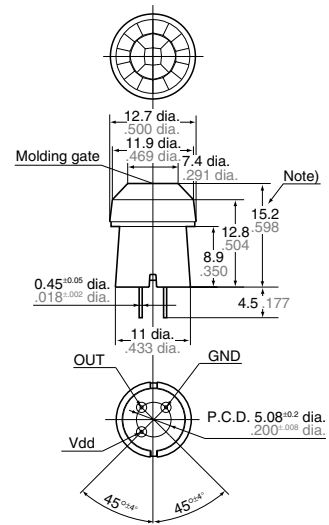

General tolerance $\pm 0.5 \pm 0.20$

Note: The height dimension does not include the remaining molding gate.

5. NaPiOn series Spot detection type

CAD Data

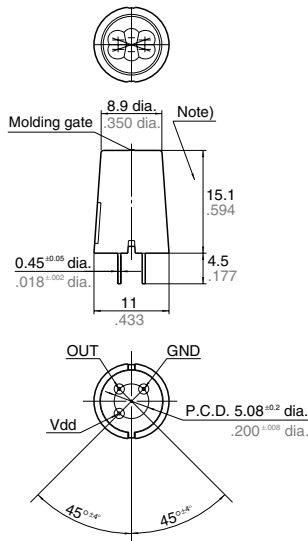

General tolerance $\pm 0.5 \pm 0.20$

6. NaPiOn series 10m detection type

CAD Data

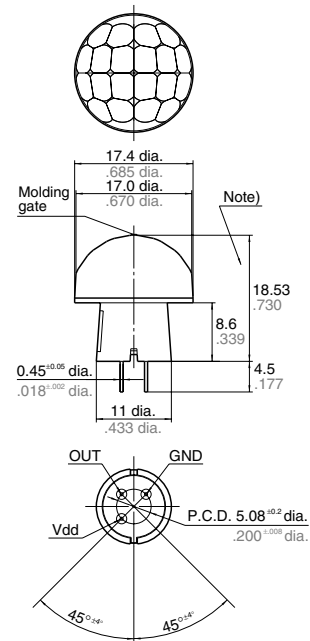

General tolerance $\pm 0.5 \pm 0.20$

Note: The height dimension does not include the remaining molding gate.

HOW TO USE

1. Block diagram output circuit

1) Digital output

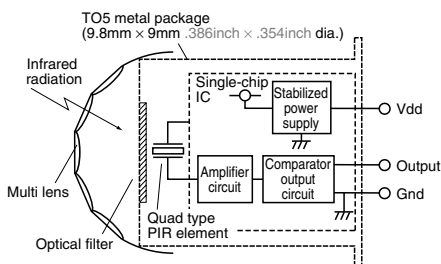

2) Analog output

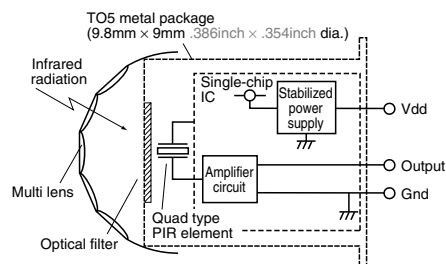

PIR Motion Sensor (EKMB, EKMC, AMN2, 3)

2. Wiring diagram

1) Digital output

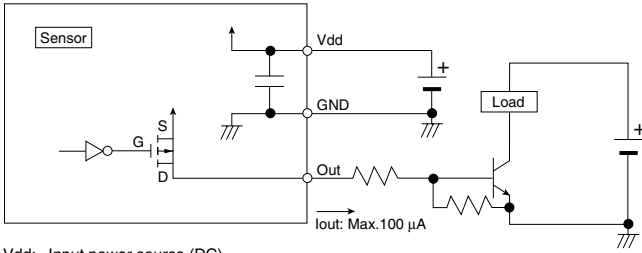

Vdd: Input power source (DC)
GND: GND
Out: Output (Comparator)

2) Analog output

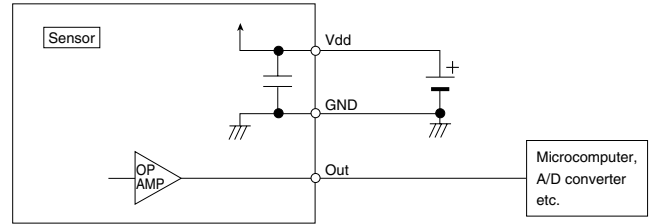

3. Timer circuit example

1) Digital output

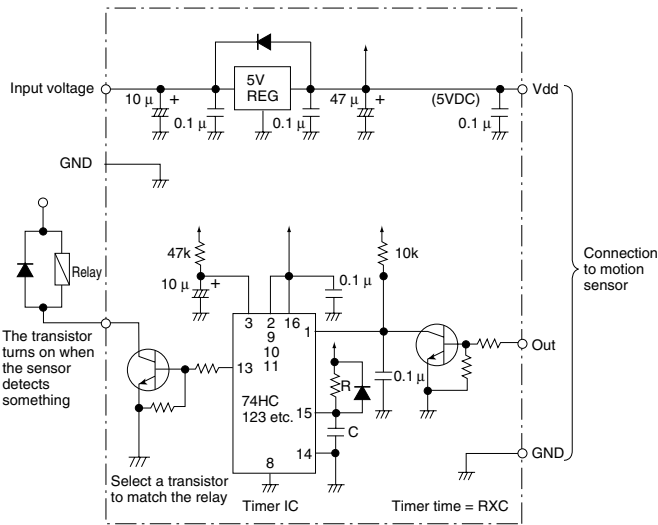

2) Analog output

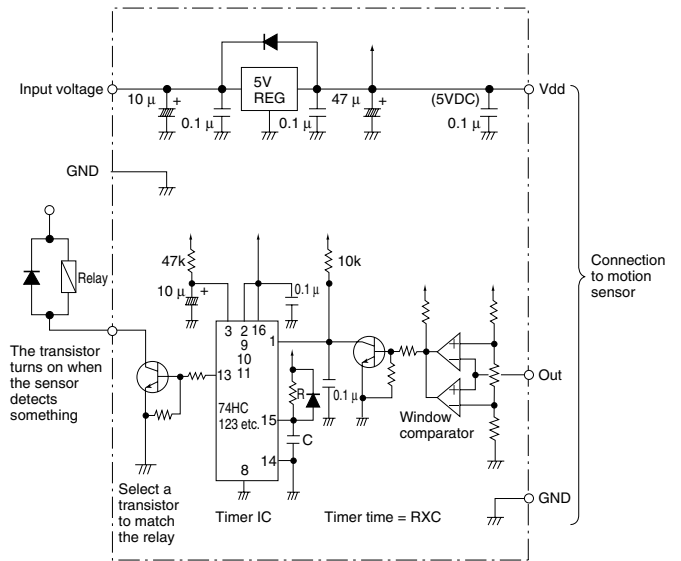

Note: This is the reference circuit which drives the PIR motion sensor. Install a noise filter for applications requiring enhanced detection reliability and noise withstanding capability.
Differences in the specifications of electronic components to which the units are connected sometimes affect their correct operation; please check the units' performance and reliability for each application.
Panasonic Corporation, Ltd. accepts no responsibility for damages resulting from the use of this circuit.

4. Timing chart

1) Digital output

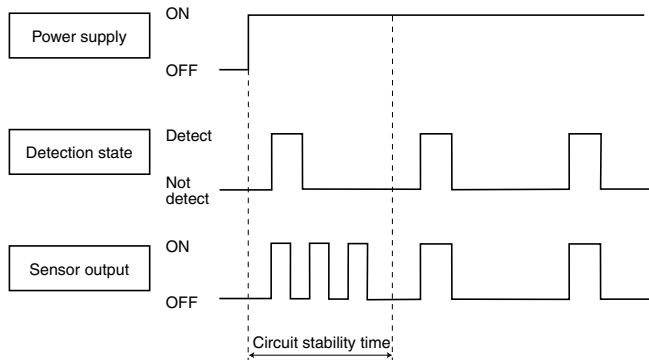

Note: Circuit stability time: 30s max.
While the circuitry is stabilizing after the power is turned on, the sensor output is not fixed in the "on" state or "off" state. This is true regardless of whether or not the sensor has detected anything.

2) Analog output

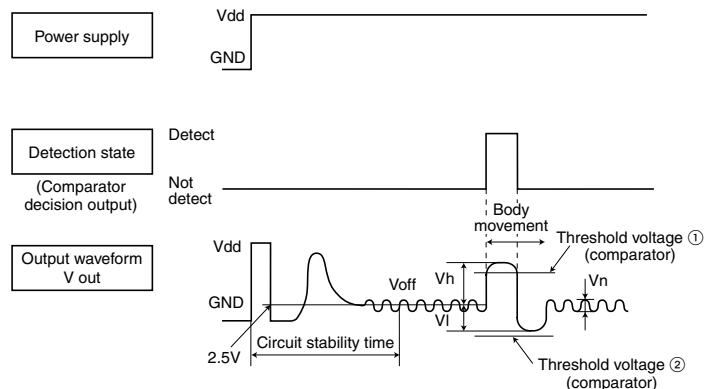

Note: Circuit stability time: 45s max.
While the circuitry is stabilizing after the power is turned on, the sensor output is not fixed in the "on" state or "off" state. This is true regardless of whether or not the sensor has detected anything.

PIR Motion Sensor (EKMB, EKMC, AMN2, 3)

MOUNTING DIRECTION

1) Detection area

As shown on the diagram, the detection zone is polarized. If a target enters the detection zones + and - at the same time, the signals are respectively cancelled and detection could become impossible at maximum detection range.

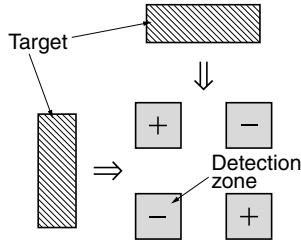

2) Direction

As detailed on the diagram, please install the sensor so that the expected trespassing direction corresponds to the axis X or axis Y.

In some cases, going back and forth towards the sensor (parallel movement to the axis Z), may not be detected.

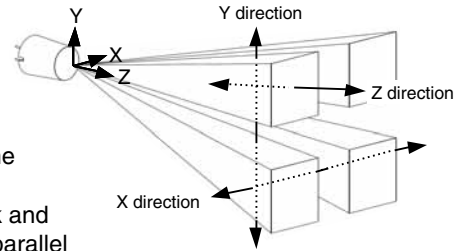

NOTES

1. Checkpoints relating to principal of operation

PaPIRs is a pyroelectric infrared sensor that detect variations in infrared rays. However, it may not detect in the following case: lack of movement, No temperature change in the heat source. Beside, it could also detect the presence of heat sources other than a human body. Efficiency and reliability of the system may vary depending actual operating conditions:

1) Detecting heat sources other than the human body, such as

(1) Small animals entering the detection area.

(2) When a heat source for example sunlight, incandescent light, car headlights etc, or strong light beam hit the sensor regardless inside or outside the detection area.

(3) Sudden temperature change inside or around the detection area caused by hot or cold wind from HVAC, or vapor from the humidifier, etc.

2) Difficulty in sensing the heat source

(1) Glass, acrylic or similar materials standing between the target and the sensor may not allow a correct transmission of infrared rays.

(2) Non-movement or quick movements of the heat source inside the detection area. (Please refer to the section on the detection performance ratings for details about movement speed.)

3) Expansion of the detection area

In case of considerable difference in the ambient temperature and the human body temperature, detection area may be wider apart from the configured detection area.

4) Malfunction/Detection error

Unnecessary detection signal might be outputted, on rare occasions, come from sudden outbreak output due to the nature of pyroelectric element. When the application does not accept such conditions strictly, please implement the countermeasure by introducing pulse count circuit etc.

2. Optimal operating environment conditions

1) Temperature: Refer to the absolute maximum rating.

2) Humidity degree: 15 to 85%Rh (Avoid condensation or freezing of this product)

3) Pressure: 86 to 106KPa

4) Overheating, oscillations, shocks can cause the sensor to malfunction.

5) This sensor is not waterproof or dustproof. Avoid use in environments subject to excessive moisture,

condensation, frost, containing salt air or dust.

6) Avoid use in environments with corrosive gases.

3. Handling cautions

1) Do not solder with a soldering iron above 350°C 662°F, or for more than 3 seconds. This sensor should be hand soldered.

2) To maintain stability of the product, always mount on a printed circuit board.

3) Do not use liquids to wash the sensor. If washing fluid gets through the lens, it can reduce performance.

4) Do not use a sensor after it fell on the ground.

5) The sensor may be damaged by ± 200 volts of static electricity. Avoid direct hand contact with the pins and be very careful when operating the product.

6) When wiring the product, always use shielded cables and minimize the wiring length to prevent noise disturbances.

7) The inner circuit board could be destroyed by a voltage surge.

Use of surge absorption elements is highly recommended.

Surge resistance: below the power supply voltage value indicated in the maximum rated values section.

8) Please use a stabilized power supply. Power supply noise can cause operating errors.

Noise resistance: $\pm 20V$ or less (Square waves with a width of 50ns or 1 μ s)

To reduce the effect of power supply noise, install a capacitor on the sensor's power supply pin.

9) Operating errors can be caused by noise from static electricity, lightning, cell phone, amateur radio, broadcasting offices etc...

10) Detection performance can be reduced by dirt on the lens.

11) The lens is made of soft materials (Polyethylene). Please avoid adding weight or impacts that might change its shape, causing operating errors or reduce performance.

12) Operating "temperatures" and "humidity level" are suggested to prolong usage. However, they do not guarantee durability or environmental resistance.

Generally, high temperatures or high humidity levels will accelerate the deterioration of electrical components. Please consider both the planned usage and environment to determine the expected reliability and length of life of the product.

13) Do not attempt to clean this product with any detergent or solvent, such as benzene or alcohol, as these can cause shape or color alterations.

14) Avoid storage in high, low temperature or liquid environments. As well, avoid storage in environments containing corrosive gas, dust, salty air etc. It could cause performance deterioration and the sensor's main part or the metallic connectors could be damaged.

For Cautions for Use.

X-ON Electronics

Largest Supplier of Electrical and Electronic Components

Click to view similar products for [Board Mount Motion & Position Sensors](#) category:

Click to view products by [Panasonic](#) manufacturer:

Other Similar products are found below :

[SV03A103AEA01B00](#) [601HE0000B01](#) [6SS4](#) [IRA-S510ST01](#) [KMA221J](#) [XL-10043](#) [F02008062](#) [M10-JK8002C](#) [UM7-LT ORIENTATION SENSOR](#) [UM7 ORIENTATION SENSOR](#) [AMN33111J](#) [MTS-360-1A-C0000-ERA360-05E](#) [F01551006](#) [AMN11111](#) [AMN24112](#) [AMN31111](#) [AMN31112](#) [AMN34112](#) [AMN34111](#) [AMN23111](#) [SV03A103AEA01R00](#) [EKMC1693113](#) [EKMB1303111K](#) [EKMB1293112](#) [PST360-11302-1P-C0000-ERA360-24E-F100](#) [AMBA340215](#) [AMBA210205](#) [AMA115915](#) [A1324LLHLTT](#) [MLX91204KDC-ABA-001-SP](#) [EKMC1605111](#) [MLX90380LDC-BAB-120-SP](#) [02183000-000](#) [3382H-1-104](#) [EKMB1104111](#) [EKMB1204111](#) [EKMB1305111K](#) [EKMC1604112](#) [EKMB1305112K](#) [EKMB1205111](#) [EKMB1205112](#) [AMBA240202](#) [EKMB1304113K](#) [EKMB1105111](#) [EKMB1105112](#) [EKMC1693112](#) [EKMC1605112](#) [MLX90316EDC-BCG-000-SP](#) [EKMB1305113K](#) [AMBA345912](#)