

ENERGIZER EN92

**AAA**



**Specifications**

**NOT INTENDED FOR RETAIL TRADE**

<b>Classification:</b>	Alkaline
<b>Chemical System:</b>	Zinc-Manganese Dioxide (Zn/MnO <sub>2</sub> ) No added mercury or cadmium
<b>Designation:</b>	ANSI-24A, IEC-LR03
<b>Nominal Voltage:</b>	1.5 volts
<b>Nominal IR:</b>	150 to 300 milliohms (fresh)
<b>Operating Temp:</b>	-18°C to 55°C (0°F to 130°F)
<b>Typical Weight:</b>	11.5 grams (0.4 oz.)
<b>Typical Volume:</b>	3.8 cubic centimeters (0.2 cubic inch)
<b>Jacket:</b>	Plastic Label
<b>Shelf Life:</b>	7 years at 21°C
<b>Terminal:</b>	Flat Contact

**Industry Standard Dimensions**

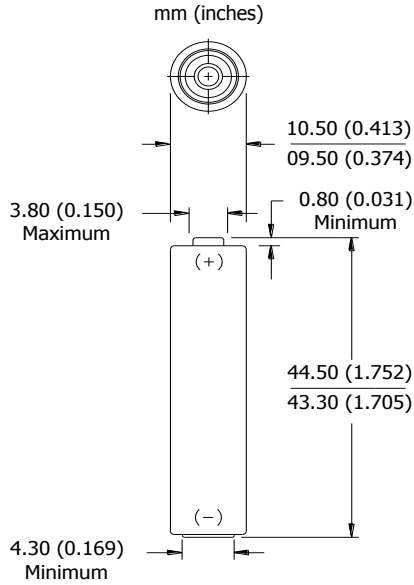

**Milliamp-Hours Capacity**

Continuous discharge to 0.8 volts at 21°C

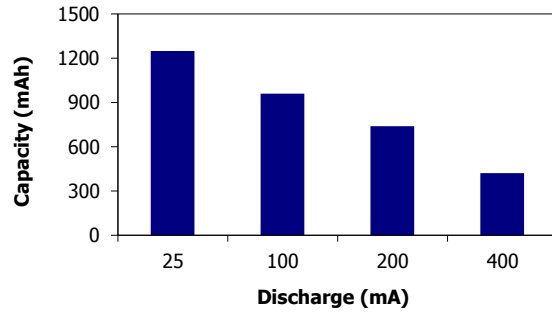

**Constant Power Performance**

Typical Characteristics (21°C)

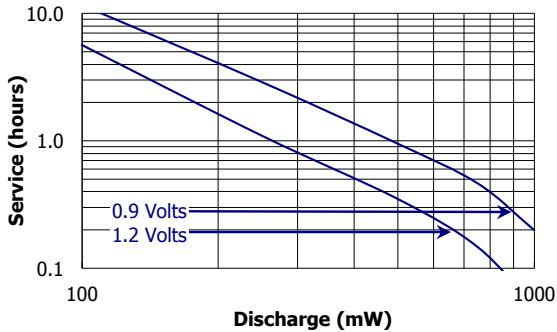

**Constant Current Performance**

Typical Characteristics (21°C)

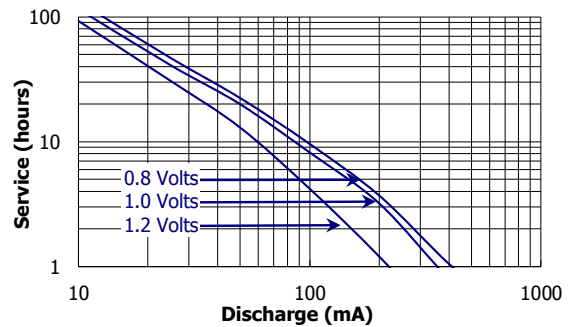

**Important Notice**

This data sheet contains typical information specific to products manufactured at the time of its publication.  
©Energizer Holdings, Inc. - Contents herein do not constitute a warranty.

**ENERGIZER EN92**



**Constant Power Performance**

Discharge Characteristics (21°C)

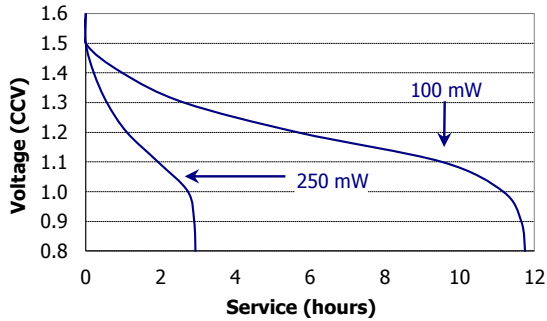

**Constant Current Performance**

250 mA Discharge (-20°C / 0°C / 21°C)

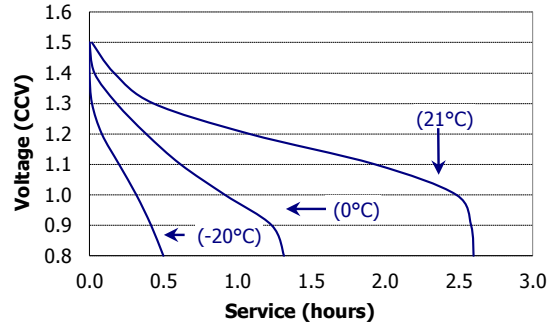

**Industry Standard Tests (21°C)**

**LIGHTING**  
5.1 ohm LIF

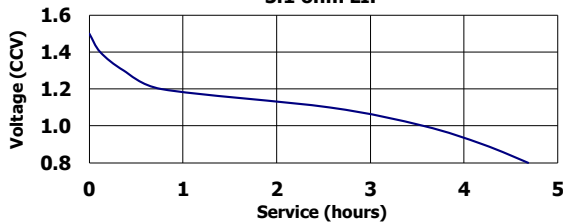

**REMOTE**  
24 ohm 15 sec/min 8 hrs/day

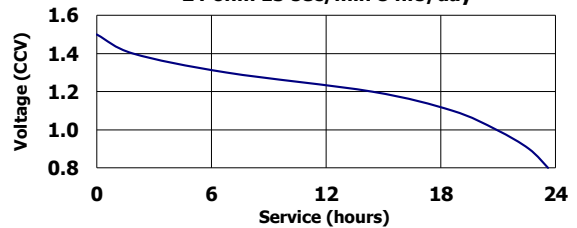

**TAPE-GAME-DIGITAL AUDIO**  
100 mA 1 hr/day

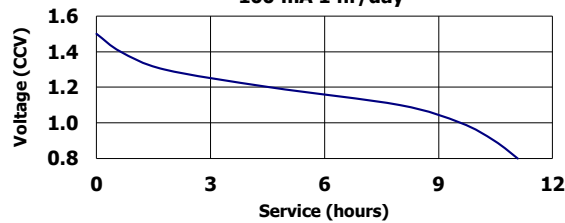

**PHOTOFLASH**  
600 mA 10 sec/min 1 hr/day

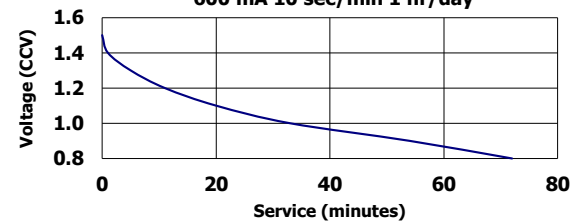

**Important Notice**

This data sheet contains typical information specific to products manufactured at the time of its publication.  
©Energizer Holdings, Inc. - Contents herein do not constitute a warranty.

## X-ON Electronics

Largest Supplier of Electrical and Electronic Components

*Click to view similar products for [energizer manufacturer](#):*

Other Similar products are found below :

[1215F2X3](#) [E11A B2](#) [LR43 186](#) [AC13](#) [AC675](#) [3LR12](#) [603298](#) [625304](#) [638006](#) [639830](#) [S9025](#) [7638900426687](#) [7638900414660](#) [HARD CASE RECHARGEABLE](#) [HARD CASE PRO MULTI USE](#) [HCHD311](#) [S9029](#) [639826](#) [603386](#) [HARD CASE PROFF 4AA](#) [HARDCASE PRO HEADLIGHT](#) [639618](#) [RCLINM2WR](#) [S8865](#) [S8707](#) [S8100](#) [7638900424478](#) [7638900313130](#) [626177](#) [E300116200](#) [E300280600](#) [639838](#) [HARDCASE PRO WORK LIGHT](#) [603305](#) [METAL LED 6AA](#) [S8864](#) [HDD32E](#) [MS2AALED](#) [ENERGIZER® 2-IN-1 LANTERN HANDHELD](#) [E300124200](#) [E300171700](#) [ENFFL81E](#) [E300112600](#) [633474](#) [HDA32E](#) [7638900421422](#) [HARD CASE PRO PIVOT](#) [HCSP61E](#) [7638900424485](#) [HDC32E](#)