



## SMT inductors

SIMID series, SIMID 1210-T

**Series/Type:** B82422T

**Date:** October 2012

© EPCOS AG 2015. Reproduction, publication and dissemination of this publication, enclosures hereto and the information contained therein without EPCOS' prior express consent is prohibited.

EPCOS AG is a TDK Group Company.

**SIMID 1210-T**
**SMD**

**Size 1210 (EIA) or 3225 (IEC)**  
**Rated inductance 0.010 ... 100  $\mu$ H**  
**Rated current 60 ... 450 mA**

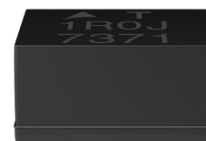
**Construction**

- Ceramic or ferrite core
- Laser-welded winding
- Flame-retardant molding

**Features**

- High Q factor
- High resonance frequency
- High L value
- Qualified to AEC-Q200
- Suitable for lead-free reflow soldering as referenced in JEDEC J-STD 020D
- RoHS-compatible

**Applications**

- Filtering of supply voltages, coupling, decoupling
- Antenna systems
- Automotive electronics
- Telecommunications
- Consumer and data processing equipment
- Industrial electronics

**Terminals**

- Base material CuSn6
- Layer composition Cu, Ag, Sn (lead-free)<sup>1)</sup>
- Electro-plated

**Marking**

- Marking on component:  
 Manufacturer and letter "T", L value (in  $\mu$ H), tolerance of L value (coded), date of manufacture (YWWD)
- Minimum data on reel:  
 Manufacturer, ordering code, L value, quantity, date of packing

**Delivery mode and packing units**

- 8-mm blister tape, wound on 180-mm or 330-mm  $\varnothing$  reel
- Packing units:  
 180-mm reel: 2000 pcs./reel  
 330-mm reel: 8000 pcs./reel

1) Ni-barrier-plated terminals (NiSn) on request (B82422T\*50).

**SIMID 1210-T**

**SMD**

**Dimensional drawing and layout recommendation**



IND0053-6

A	B	C	D
2.7	1.15	2.1	4.4

1) Soldering area

IND0073-6-E

Dimensions in mm

**Taping and packing**

**Blister tape**

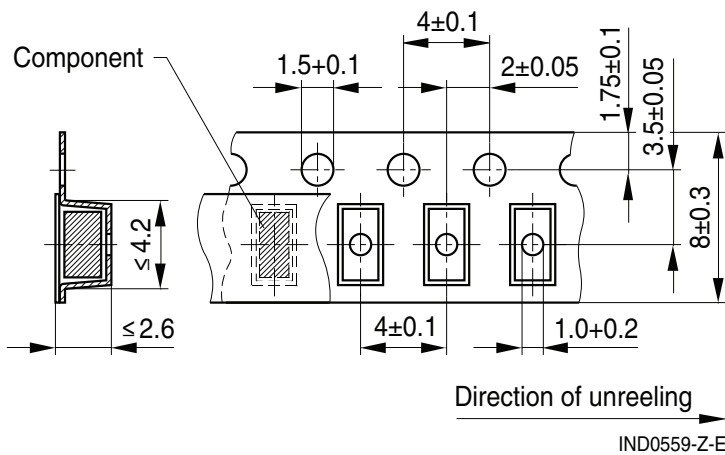

IND0559-Z-E

Dimensions in mm

**Reel**

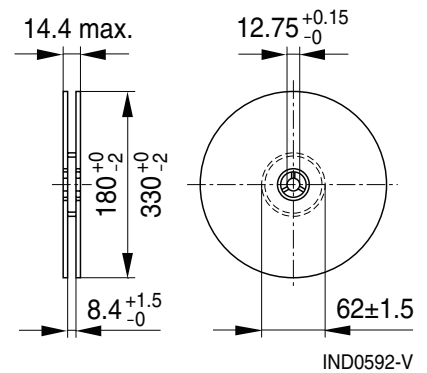

IND0592-V

**SMD**
**Technical data and measuring conditions**

Rated inductance $L_R$	Measured with impedance analyzer Agilent 4294A at frequency $f_L$ , 0.1 V, +20 °C
Q factor $Q_{min}$	Measured with impedance analyzer Agilent 4294A at frequency $f_Q$ , +20 °C
Rated temperature $T_R$	+85 °C
Rated current $I_R$	Maximum permissible DC with inductance decrease $\Delta L/L_0 \leq 10\%$ and temperature increase of $\leq 30$ K at rated temperature
Self-resonance frequency $f_{res,min}$	Measured with impedance analyzer Agilent E4991A / network analyzer Agilent E8362B, +20 °C
DC resistance $R_{max}$	Measured at +20 °C
Solderability (lead-free)	Sn95.5Ag3.8Cu0.7: +(245 ±5) °C, (5 ±0.3) s Wetting of soldering area $\geq 90\%$ (based on IEC 60068-2-58)
Resistance to soldering heat	+260 °C, 40 s (as referenced in JEDEC J-STD 020D)
Climatic category	55/125/56 (to IEC 60068-1)
Storage conditions	Mounted: -55 °C ... +125 °C Packaged: -25 °C ... +40 °C, $\leq 75\%$ RH
Weight	Approx. 50 mg

**SIMID 1210-T**
**SMD**
**Characteristics and ordering codes**

$L_R$ $\mu\text{H}$	Tolerance	$Q_{\min}$	$f_L; f_Q$ MHz	$I_R$ mA	$R_{\max}$ $\Omega$	$f_{\text{res, min}}$ MHz	Ordering code <sup>1)2)</sup> ( $\varnothing$ 180-mm reel)
Core material: ceramic							
0.010	$\pm 5\% \triangleq J$	15	100	450	0.10	4000	B82422T3100+000
0.012	$\pm 10\% \triangleq K$	17	100	450	0.11	3500	B82422T3120+000
0.015		19	100	450	0.13	3000	B82422T3150+000
0.018		21	100	450	0.14	2000	B82422T3180+000
0.022		23	100	450	0.16	2000	B82422T3220+000
0.027		23	100	450	0.17	1700	B82422T3270+000
0.033		25	100	450	0.18	1700	B82422T3330+000
0.039		25	100	450	0.19	1300	B82422T3390+000
0.047		26	100	450	0.20	1300	B82422T3470+000
0.056		26	100	450	0.21	1100	B82422T3560+000
0.068		27	100	450	0.23	1000	B82422T3680+000
0.082		27	100	450	0.26	1000	B82422T3820+000
0.10		28	100	450	0.31	900	B82422T3101+000

**Core material: ferrite**

0.12	$\pm 5\% \triangleq J$	30	25.2	450	0.15	900	B82422T1121+000
0.15	$\pm 10\% \triangleq K$	30	25.2	450	0.18	700	B82422T1151+000
0.18		30	25.2	450	0.19	500	B82422T1181+000
0.22		30	25.2	450	0.20	500	B82422T1221+000
0.27		30	25.2	450	0.21	500	B82422T1271+000
0.33		30	25.2	450	0.23	500	B82422T1331+000
0.39		30	25.2	450	0.25	400	B82422T1391+000
0.47		30	25.2	450	0.30	400	B82422T1471+000
0.56		30	25.2	450	0.31	300	B82422T1561+000
0.68		30	25.2	450	0.34	300	B82422T1681+000
0.82		30	25.2	450	0.38	300	B82422T1821+000
1.0		30	7.96	400	0.6	300	B82422T1102+000
1.2		30	7.96	390	0.7	250	B82422T1122+000

Closer tolerances and special versions on request.

Higher currents possible at temperatures  $< T_R$  on request.

Sample kit available. Ordering code: B82422X001

For more information refer to chapter "Sample kits".

1) Replace the + by the code letter for the required inductance tolerance.

For reel size  $\varnothing$  330 mm the last digit has to be an »8«. Example: B82422T3100K008

2) For Ni-barrier-plated terminals replace the last two digits "00" by "50" (reel 180 mm) or "58" (reel 330 mm).

**SMD**
**Characteristics and ordering codes**

$L_R$ $\mu\text{H}$	Tolerance	$Q_{\min}$	$f_L; f_Q$ MHz	$I_R$ mA	$R_{\max}$ $\Omega$	$f_{\text{res,min}}$ MHz	Ordering code <sup>1)2)</sup> ( $\varnothing$ 180-mm reel)
1.5	$\pm 5\% \triangle J$	30	7.96	370	0.7	200	B82422T1152+000
1.8	$\pm 10\% \triangle K$	30	7.96	350	0.8	140	B82422T1182+000
2.2		30	7.96	320	0.8	100	B82422T1222+000
2.7		30	7.96	290	0.9	70	B82422T1272+000
3.3		30	7.96	260	1.2	60	B82422T1332+000
3.9		30	7.96	250	1.3	60	B82422T1392+000
4.7		30	7.96	220	1.5	50	B82422T1472+000
5.6		27	7.96	200	1.6	45	B82422T1562+000
6.8		27	7.96	180	1.8	40	B82422T1682+000
8.2		27	7.96	170	2.0	35	B82422T1822+000
10		27	2.52	150	2.1	30	B82422T1103+000
12		27	2.52	140	2.5	25	B82422T1123+000
15		27	2.52	130	2.8	20	B82422T1153+000
18		27	2.52	120	3.0	20	B82422T1183+000
22		27	2.52	110	3.5	20	B82422T1223+000
27		27	2.52	80	4.5	20	B82422T1273+000
33	27	2.52	70	5.6	17	B82422T1333+000	
39	27	2.52	65	6.4	16	B82422T1393+000	
47	27	2.52	60	7.0	15	B82422T1473+000	
56	27	2.52	60	8.0	12	B82422T1563+000	
68	27	2.52	60	9.0	9	B82422T1683+000	
82	25	2.52	60	10	9	B82422T1823+000	
100	20	0.796	60	11	8	B82422T1104+000	

Closer tolerances and special versions on request.

Higher currents possible at temperatures  $<T_R$  on request.

Sample kit available. Ordering code: B82422X001

For more information refer to chapter "Sample kits".

1) Replace the + by the code letter for the required inductance tolerance.

For reel size  $\varnothing$  330 mm the last digit has to be an »8«. Example: B82422T1104K008

2) For Ni-barrier-plated terminals replace the last two digits "00" by "50" (reel 180 mm) or "58" (reel 330 mm).

**SMD**

**Impedance  $|Z|$  versus frequency  $f$**   
measured with impedance analyzer  
Agilent E4991A, typical values at +20 °C

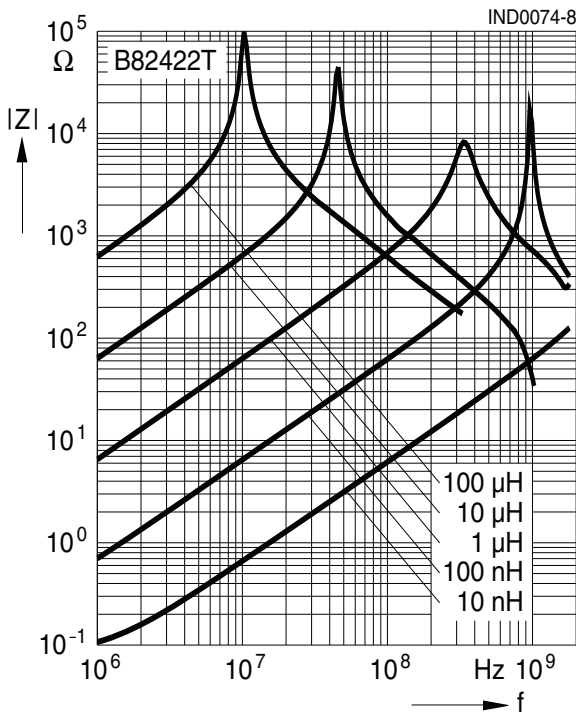

**Inductance  $L$  versus DC load current  $I_{DC}$**   
measured with LCR meter Agilent 4285A,  
typical values at +20 °C

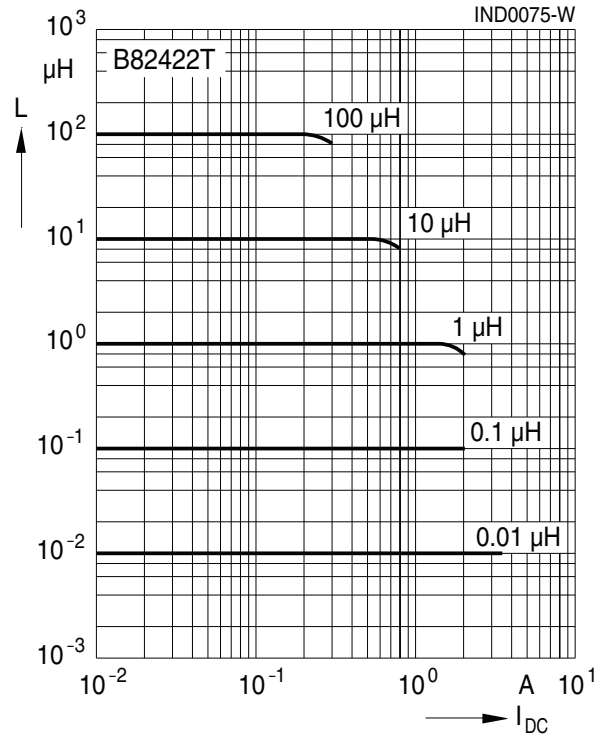

**Q factor versus frequency  $f$**   
measured with impedance analyzer Agilent  
E4991A, typical values at +20 °C

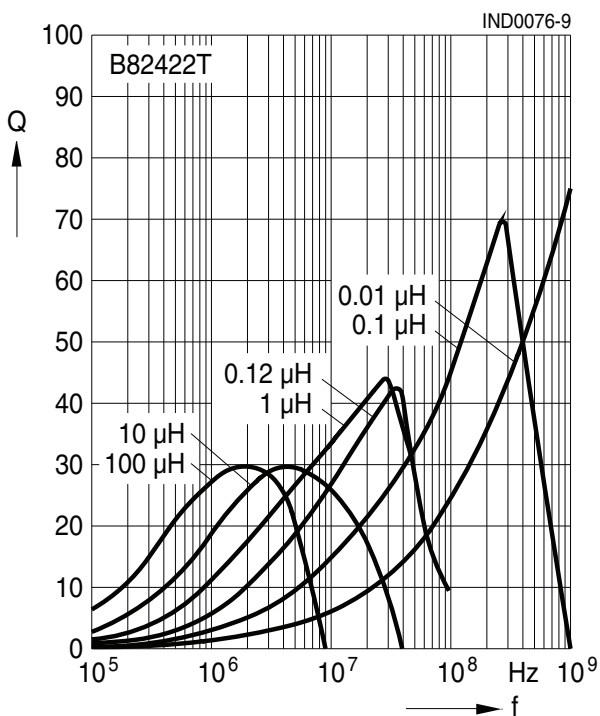

**Current derating  $I_{op}/I_R$**   
**versus ambient temperature  $T_A$**   
(rated temperature  $T_R = +85$  °C)

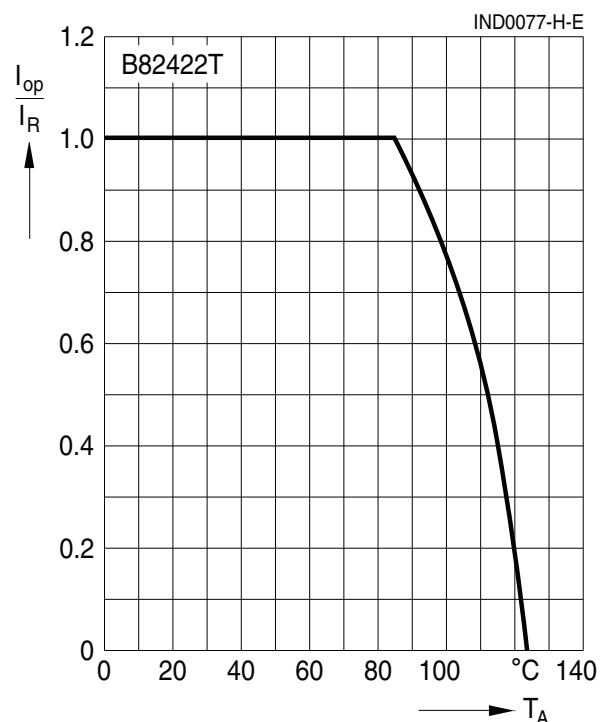

## Cautions and warnings

- Please note the recommendations in our Inductors data book (latest edition) and in the data sheets.
  - Particular attention should be paid to the derating curves given there.
  - The soldering conditions should also be observed. Temperatures quoted in relation to wave soldering refer to the pin, not the housing.
- If the components are to be washed varnished it is necessary to check whether the washing varnish agent that is used has a negative effect on the wire insulation, any plastics that are used, or on glued joints. In particular, it is possible for washing varnish agent residues to have a negative effect in the long-term on wire insulation.  
Washing processes may damage the product due to the possible static or cyclic mechanical loads (e.g. ultrasonic cleaning). They may cause cracks to develop on the product and its parts, which might lead to reduced reliability or lifetime.
- The following points must be observed if the components are potted in customer applications:
  - Many potting materials shrink as they harden. They therefore exert a pressure on the plastic housing or core. This pressure can have a deleterious effect on electrical properties, and in extreme cases can damage the core or plastic housing mechanically.
  - It is necessary to check whether the potting material used attacks or destroys the wire insulation, plastics or glue.
  - The effect of the potting material can change the high-frequency behaviour of the components.
- Ferrites are sensitive to direct impact. This can cause the core material to flake, or lead to breakage of the core.
- Even for customer-specific products, conclusive validation of the component in the circuit can only be carried out by the customer.



## Important notes

The following applies to all products named in this publication:

1. Some parts of this publication contain **statements about the suitability of our products for certain areas of application**. These statements are based on our knowledge of typical requirements that are often placed on our products in the areas of application concerned. We nevertheless expressly point out **that such statements cannot be regarded as binding statements about the suitability of our products for a particular customer application**. As a rule, EPCOS is either unfamiliar with individual customer applications or less familiar with them than the customers themselves. For these reasons, it is always ultimately incumbent on the customer to check and decide whether an EPCOS product with the properties described in the product specification is suitable for use in a particular customer application.
2. We also point out that **in individual cases, a malfunction of electronic components or failure before the end of their usual service life cannot be completely ruled out in the current state of the art, even if they are operated as specified**. In customer applications requiring a very high level of operational safety and especially in customer applications in which the malfunction or failure of an electronic component could endanger human life or health (e.g. in accident prevention or life-saving systems), it must therefore be ensured by means of suitable design of the customer application or other action taken by the customer (e.g. installation of protective circuitry or redundancy) that no injury or damage is sustained by third parties in the event of malfunction or failure of an electronic component.
3. **The warnings, cautions and product-specific notes must be observed.**
4. In order to satisfy certain technical requirements, **some of the products described in this publication may contain substances subject to restrictions in certain jurisdictions (e.g. because they are classed as hazardous)**. Useful information on this will be found in our Material Data Sheets on the Internet ([www.epcos.com/material](http://www.epcos.com/material)). Should you have any more detailed questions, please contact our sales offices.
5. We constantly strive to improve our products. Consequently, **the products described in this publication may change from time to time**. The same is true of the corresponding product specifications. Please check therefore to what extent product descriptions and specifications contained in this publication are still applicable before or when you place an order.

We also **reserve the right to discontinue production and delivery of products**. Consequently, we cannot guarantee that all products named in this publication will always be available. The aforementioned does not apply in the case of individual agreements deviating from the foregoing for customer-specific products.

6. Unless otherwise agreed in individual contracts, **all orders are subject to the current version of the “General Terms of Delivery for Products and Services in the Electrical Industry” published by the German Electrical and Electronics Industry Association (ZVEI)**.
7. The trade names EPCOS, BAOKE, Alu-X, CeraDiode, CeraLink, CSMP, CSSP, CTVS, DeltaCap, DigiSiMic, DSSP, FilterCap, FormFit, MiniBlue, MiniCell, MKD, MKK, MLSC, MotorCap, PCC, PhaseCap, PhaseCube, PhaseMod, PhiCap, SIFERRIT, SIFI, SIKOREL, SilverCap, SIMDAD, SiMic, SIMID, SineFormer, SIOV, SIP5D, SIP5K, ThermoFuse, WindCap are **trademarks registered or pending** in Europe and in other countries. Further information will be found on the Internet at [www.epcos.com/trademarks](http://www.epcos.com/trademarks).

## X-ON Electronics

Largest Supplier of Electrical and Electronic Components

*Click to view similar products for [Multilayer Ceramic Capacitors MLCC - SMD/SMT](#) category:*

*Click to view products by [EPCOS](#) manufacturer:*

Other Similar products are found below :

[M39014/01-1467](#) [M39014/02-1218V](#) [M39014/02-1225V](#) [M39014/02-1262V](#) [M39014/02-1301](#) [M39014/22-0631](#) [1210J5000102JCT](#)  
[1210J2K00102KXT](#) [1210J5000103KXT](#) [1210J5000223KXT](#) [D55342E07B379BR-TR](#) [D55342E07B523DR-T/R](#) [1812J1K00103KXT](#)  
[1812J1K00473KXT](#) [1812J2K00680JCT](#) [1812J4K00102MXT](#) [1812J5000102JCT](#) [1812J5000103JCT](#) [1812J5000682JCT](#) [NIN-FB391JTRF](#)  
[NIN-FC2R7JTRF](#) [NPIS27H102MTRF](#) [C1206C101J1GAC](#) [C1608C0G1E472JT000N](#) [C2012C0G2A472J](#) [2220J2K00101JCT](#)  
[KHC201E225M76N0T00](#) [LRC-LRF1206LF-01R025FTR1K](#) [1812J1K00222JCT](#) [1812J2K00102KXT](#) [1812J2K00222KXT](#)  
[1812J2K00472KXT](#) [2-1622820-7-CUT-TAPE](#) [2220J3K00102KXT](#) [2225J2500824KXT](#) [CCR07CG103KM](#) [CGA2B2C0G1H010C](#)  
[CGA2B2C0G1H040C](#) [CGA2B2C0G1H050C](#) [CGA2B2C0G1H060D](#) [CGA2B2C0G1H070D](#) [CGA2B2C0G1H151J](#) [CGA2B2C0G1H1R5C](#)  
[CGA2B2C0G1H2R2C](#) [CGA2B2C0G1H3R3C](#) [CGA2B2C0G1H680J](#) [CGA2B2C0G1H6R8D](#) [CGA2B2X8R1H221K](#) [CGA2B2X8R1H472K](#)  
[CGA3E1X7R1C474K](#)