



KK 156 PCB ASSY 2-15 CKT

41815 SERIES

Assy. Proc:	RIGHT ANGLE
Housing No:	41815-N-AN
Options	WITH RAMP
Terminal No:	2144-BA-A1AA-197B
Term Matl:	PHOS BRONZE
Plating:	197 TIN
Dim C:	(3.68) / .145
Voids:	NONE
Hooks Cut:	NO
Packaging:	PK-41815-001 TRAY

Assy. Proc:	RIGHT ANGLE
Housing No:	41815-N-AN
Options	WITH RAMP
Terminal No:	2144-BA-A1AA-208B
Term Matl:	PHOS BRONZE
Plating:	208 – 15 GOLD
Dim C:	(3.68) / .145
Voids:	NONE
Hooks Cut:	NO
Packaging:	PK-41815-001 TRAY

Assy. Proc:	BOTTOM ENTRY
Housing No:	41815-N-AN
Options	WITH RAMP
Terminal No:	6298-1-197
Term Matl:	PHOS BRONZE
Plating:	197 – TIN
Dim C:	(3.18)/. 125
Voids:	NONE
Hooks Cut:	NO
Packaging:	PK-41815-001 TRAY

Assy. Proc:	BOTTOM ENTRY
Housing No:	41815-N-AN
Options	WITH RAMP
Terminal No:	6298-1-208
Term Matl:	PHOS BRONZE
Plating:	208 – 15 GOLD
Dim C:	(3.18)/. 125
Voids:	NONE
Hooks Cut:	NO
Packaging:	PK-41815-001 TRAY

Ckts	Material No	Engineer Number
2	09-48-1024	A-41815-0002
3	09-48-1034	A-41815-0003
4	09-48-1044	A-41815-0004
5	09-48-1054	A-41815-0005
6	09-48-1064	A-41815-0006
7	09-48-1074	A-41815-0007
8	09-48-1084	A-41815-0008
9	09-48-1094	A-41815-0009
10	09-48-1104	A-41815-0010
11	09-48-1114	A-41815-0011
12	09-48-1124	A-41815-0012
13	09-48-1134	A-41815-0013
14	09-48-1144	A-41815-0014
15	09-48-1154	A-41815-0015

Material No	Engineer Number
09-48-5024	A-41815-0016
09-48-5034	A-41815-0017
09-48-5044	A-41815-0018
09-48-5054	A-41815-0019
09-48-5064	A-41815-0020
09-48-5074	A-41815-0021
09-48-5084	A-41815-0022
09-48-5094	A-41815-0023
09-48-5104	A-41815-0024
09-48-5114	A-41815-0025
09-48-5124	A-41815-0026
09-48-5134	A-41815-0027
09-48-5144	A-41815-0028
09-48-5154	A-41815-0029

Material No	Engineer Number
09-48-4029	A-41815-0030
09-48-4039	A-41815-0031
09-48-4049	A-41815-0032
09-48-4059	A-41815-0033
09-48-4069	A-41815-0034
09-48-4079	A-41815-0035
09-48-4089	A-41815-0036
09-48-4099	A-41815-0037
09-48-4109	A-41815-0038
09-48-4119	A-41815-0039
09-48-4129	A-41815-0040
09-48-4139	A-41815-0041
09-48-4149	A-41815-0042
09-48-4159	A-41815-0043

Material No	Engineer Number
09-48-5026	A-41815-0044
09-48-5036	A-41815-0045
09-48-5046	A-41815-0046
09-48-5056	A-41815-0047
09-48-5066	A-41815-0048
09-48-5076	A-41815-0049
09-48-5086	A-41815-0050
09-48-5096	A-41815-0051
09-48-5106	A-41815-0052
09-48-5116	A-41815-0053
09-48-5126	A-41815-0054
09-48-5136	A-41815-0055
09-48-5146	A-41815-0056
09-48-5156	A-41815-0057

AN3	<u>REV:</u>		<u>ECR/ECN INFORMATION:</u>	<u>TITLE:</u>			<u>SHEET No.</u>		
			UCP2015-1357	KK 156 HOUSING ASSY PCB			- 2 -		
			11/10/2014	41815 SERIES DWG					
<u>DOCUMENT NUMBER:</u>				<u>CREATED / REVISED BY:</u>		<u>CHECKED BY:</u>		<u>APPROVED BY:</u>	
SDA-41815				MKIPPER		NNGUYEN		FSMITH	



KK 156 PCB ASSY 2-15 CKT

41815 SERIES

	Assy. Proc:	TOP ENTRY	Assy. Proc:	TOP ENTRY	Assy. Proc:	BOTTOM ENTRY	Assy. Proc:	TOP ENTRY
	Housing No:	41815-N-AN	Housing No:	41815-N-AN	Housing No:	41815-N-AN	Housing No:	41815-N-AN
	Options	WITH RAMP	Options	WITH RAMP	Options	WITH RAMP	Options	WITH RAMP
	Terminal No:	2144-BA-A1AA-197B	Terminal No:	2144-BA-A1AA-208B	Terminal No:	2188-1-P909	Terminal No:	2144-AA-A1AA-P909B
	Term Matl:	PHOS BRONZE	Term Matl:	PHOS BRONZE	Term Matl:	BRASS	Term Matl:	BRASS
	Plating:	197 – TIN	Plating:	208 – 15 GOLD	Plating:	P909 – TIN	Plating:	P909 – TIN
	Dim C:	(3.05) / .120	Dim C:	(3.05) / .120	Dim C:	(3.18) / .125	Dim C:	(3.05) / .120
	Voids:	NONE	Voids:	NONE	Voids:	NONE	Voids:	NONE
	Hooks Cut:	NO	Hooks Cut:	NO	Hooks Cut:	NO	Hooks Cut:	YES
	Packaging:	PK-41815-001 TRAY	Packaging:	PK-41815-001 TRAY	Packaging:	PK-41815-001 TRAY	Packaging:	PK-41815-001 TRAY
Ckts	Material No	Engineer Number	Material No	Engineer Number	Material No	Engineer Number	Material No	Engineer Number
2	09-48-4028	A-41815-0058	09-48-5025	A-41815-0072	09-48-2022	A-41815-0100	09-48-2025	A-41815-0114
3	09-48-4038	A-41815-0059	09-48-5035	A-41815-0073	09-48-2032	A-41815-0101	09-48-2035	A-41815-0115
4	09-48-4048	A-41815-0060	09-48-5045	A-41815-0074	09-48-2042	A-41815-0102	09-48-2045	A-41815-0116
5	09-48-4058	A-41815-0061	09-48-5055	A-41815-0075	09-48-2052	A-41815-0103	09-48-2055	A-41815-0117
6	09-48-4068	A-41815-0062	09-48-5065	A-41815-0076	09-48-2062	A-41815-0104	09-48-2065	A-41815-0118
7	09-48-4078	A-41815-0063	09-48-5075	A-41815-0077	09-48-2072	A-41815-0105	09-48-2075	A-41815-0119
8	09-48-4088	A-41815-0064	09-48-5085	A-41815-0078	09-48-2082	A-41815-0106	09-48-2085	A-41815-0120
9	09-48-4098	A-41815-0065	09-48-5095	A-41815-0079	09-48-2092	A-41815-0107	09-48-2095	A-41815-0121
10	09-48-4108	A-41815-0066	09-48-5105	A-41815-0080	09-48-2102	A-41815-0108	09-48-2105	A-41815-0122
11	09-48-4118	A-41815-0067	09-48-5115	A-41815-0081	09-48-2112	A-41815-0109	09-48-2115	A-41815-0123
12	09-48-4128	A-41815-0068	09-48-5125	A-41815-0082	09-48-2122	A-41815-0110	09-48-2125	A-41815-0124
13	09-48-4138	A-41815-0069	09-48-5135	A-41815-0083	09-48-2132	A-41815-0111	09-48-2135	A-41815-0125
14	09-48-4148	A-41815-0070	09-48-5145	A-41815-0084	09-48-2142	A-41815-0112	09-48-2145	A-41815-0126
15	09-48-4158	A-41815-0071	09-48-5155	A-41815-0085	09-48-2152	A-41815-0113	09-48-2155	A-41815-0127

REV:	ECR/ECN INFORMATION:	TITLE:	SHEET No.
AN3	EC NO. UCP2015-1357	KK 156 HOUSING ASSY PCB 41815 SERIES DWG	- 3 -
	DATE: 11/10/2014		
DOCUMENT NUMBER: SDA-41815		CREATED / REVISED BY: MKIPPER	CHECKED BY: NNGUYEN
		APPROVED BY: FSMITH	



KK 156 PCB ASSY 2-15 CKT

41815 SERIES

Ckts	Assy. Proc:		Assy. Proc:		Assy. Proc:		Assy. Proc:	
	Material No	Engineer Number	Material No	Engineer Number	Material No	Engineer Number	Material No	Engineer Number
2			09-48-4021	A-41815-0170	41815-0184	A-41815-0184	09-48-2021	A-41815-0198
3			09-48-4031	A-41815-0171	09-48-5030	A-41815-0185	09-48-2031	A-41815-0199
4			09-48-4041	A-41815-0172	09-48-5040	A-41815-0186	09-48-2041	A-41815-0200
5			09-48-4051	A-41815-0173	09-48-5050	A-41815-0187	09-48-2051	A-41815-0201
6			09-48-4061	A-41815-0174	41815-0188	A-41815-0188	09-48-2061	A-41815-0202
7			09-48-4071	A-41815-0175	41815-0189	A-41815-0189	09-48-2071	A-41815-0203
8			09-48-4081	A-41815-0176	09-48-5080	A-41815-0190	09-48-2081	A-41815-0204
9			09-48-4091	A-41815-0177	41815-0191	A-41815-0191	09-48-2091	A-41815-0205
10			09-48-4101	A-41815-0178	09-48-5100	A-41815-0192	09-48-2101	A-41815-0206
11			09-48-4111	A-41815-0179	41815-0193	A-41815-0193	09-48-2111	A-41815-0207
12			09-48-4121	A-41815-0180	41815-0194	A-41815-0194	09-48-2121	A-41815-0208
13			09-48-4131	A-41815-0181	41815-0195	A-41815-0195	09-48-2131	A-41815-0209
14			09-48-4141	A-41815-0182	41815-0196	A-41815-0196	09-48-2141	A-41815-0210
15			09-48-4151	A-41815-0183	41815-0197	A-41815-0197	09-48-2151	A-41815-0211

AN3	ECR/ECN INFORMATION:		TITLE: KK 156 HOUSING ASSY PCB 41815 SERIES DWG	SHEET No.
	EC NO.	UCP2015-1357		- 4 -
	DATE:	11/10/2014		
DOCUMENT NUMBER: SDA-41815		CREATED / REVISED BY: MKIPPER	CHECKED BY: NNGUYEN	APPROVED BY: FSMITH



KK 156 PCB ASSY 2-15 CKT

41815 SERIES

Assy. Proc:	TOP ENTRY
Housing No:	41815-N-AN
Options	WITH RAMP
Terminal No:	2144-AA-A1AA-P909B
Term Matl:	BRASS
Plating:	P909 – TIN
Dim C:	(3.05) / .120
Voids:	NONE
Hooks Cut:	NO
Packaging:	PK-41815-001 TRAY

Assy. Proc:	TOP ENTRY
Housing No:	41815-N-AN
Options	WITH RAMP
Terminal No:	2144-AA-A1AA-208B
Term Matl:	BRASS
Plating:	208 – 15 GOLD
Dim C:	(3.05) / .120
Voids:	NONE
Hooks Cut:	NO
Packaging:	PK-41815-001 TRAY

Assy. Proc:	RIGHT ANGLE
Housing No:	41815-N-AN
Options	WITH RAMP
Terminal No:	2144-BA-A1AA-P909B
Term Matl:	PHOS BRONZE
Plating:	P909 – TIN
Dim C:	(3.68) / .145
Voids:	NONE
Hooks Cut:	NO
Packaging:	PK-41815-001 TRAY

Assy. Proc:	BOTTOM ENTRY
Housing No:	41815-N-AN
Options	WITH RAMP
Terminal No:	6298-1-P909
Term Matl:	PHOS BRONZE
Plating:	P909 – TIN
Dim C:	(3.18) / .125
Voids:	NONE
Hooks Cut:	NO
Packaging:	PK-41815-001 TRAY

Ckts	Material No	Engineer Number
2	09-48-2023	A-41815-0453
3	09-48-2033	A-41815-0454
4	09-48-2043	A-41815-0455
5	09-48-2053	A-41815-0456
6	09-48-2063	A-41815-0457
7	09-48-2073	A-41815-0458
8	09-48-2083	A-41815-0459
9	09-48-2093	A-41815-0460
10	09-48-2103	A-41815-0461
11	09-48-2113	A-41815-0462
12	09-48-2123	A-41815-0463
13	09-48-2133	A-41815-0464
14	09-48-2143	A-41815-0465
15	09-48-2153	A-41815-0466

Material No	Engineer Number
09-48-3026	A-41815-0467
09-48-3036	A-41815-0468
09-48-3046	A-41815-0469
09-48-3056	A-41815-0470
09-48-3066	A-41815-0471
09-48-3076	A-41815-0472
09-48-3086	A-41815-0473
09-48-3096	A-41815-0474
09-48-3106	A-41815-0475
09-48-3116	A-41815-0476
09-48-3126	A-41815-0477
09-48-3136	A-41815-0478
09-48-3146	A-41815-0479
09-48-3156	A-41815-0480

Material No	Engineer Number
09-48-2020	A-41815-0481
09-48-2030	A-41815-0482
09-48-2040	A-41815-0483
09-48-2050	A-41815-0484
09-48-2060	A-41815-0485
09-48-2070	A-41815-0486
09-48-2080	A-41815-0487
09-48-2090	A-41815-0488
09-48-2100	A-41815-0489
09-48-2110	A-41815-0490
09-48-2120	A-41815-0491
09-48-2130	A-41815-0492
09-48-2140	A-41815-0493
09-48-2150	A-41815-0494

Material No	Engineer Number
09-48-2029	A-41815-0495
09-48-2039	A-41815-0496
09-48-2049	A-41815-0497
09-48-2059	A-41815-0498
09-48-2069	A-41815-0499
09-48-2079	A-41815-0500
09-48-2089	A-41815-0501
09-48-2099	A-41815-0502
09-48-2109	A-41815-0503
09-48-2119	A-41815-0504
09-48-2129	A-41815-0505
09-48-2139	A-41815-0506
09-48-2149	A-41815-0507
09-48-2159	A-41815-0508

AN3	<u>REV:</u>		<u>ECR/ECN INFORMATION:</u>		KK 156 HOUSING ASSY PCB 41815 SERIES DWG			<u>SHEET No.</u>
			<u>EC NO.</u>	UCP2015-1357				- 7 -
			<u>DATE:</u>	11/10/2014				
<u>DOCUMENT NUMBER:</u>			<u>CREATED / REVISED BY:</u>		<u>CHECKED BY:</u>		<u>APPROVED BY:</u>	
SDA-41815			MKIPPER		NNGUYEN		FSMITH	



KK 156 PCB ASSY 2-15 CKT

41815 SERIES

Assy. Proc:	TOP ENTRY
Housing No:	41815-N-AN
Options	WITH RAMP
Terminal No:	2144-BA-A1AA-P909B
Term Matl:	PHOS BRONZE
Plating:	P909 – TIN
Dim C:	(3.05) / .120
Voids:	NONE
Hooks Cut:	NO
Packaging:	PK-41815-001 TRAY

Assy. Proc:	TOP ENTRY
Housing No:	41815-N-AN
Options	WITH RAMP
Terminal No:	2144-BA-A1AA-197B
Term Matl:	PHOS BRONZE
Plating:	197 – TIN
Dim C:	(3.05) / .120
Voids:	NONE
Hooks Cut:	YES
Packaging:	PK-41815-001 TRAY

Assy. Proc:	TOP ENTRY
Housing No:	41815-N-AN
Options	WITH RAMP
Terminal No:	2144-BA-A1AA-208B
Term Matl:	PHOS BRONZE
Plating:	208 – 15 GOLD
Dim C:	(3.05) / .120
Voids:	NONE
Hooks Cut:	YES
Packaging:	PK-41815-001 TRAY

Assy. Proc:	BOTTOM ENTRY
Housing No:	41815-N-AN
Options	WITH RAMP
Terminal No:	2188-1-208
Term Matl:	BRASS
Plating:	208 – 15 GOLD
Dim C:	(3.18) / .125
Voids:	TERMINAL VOID 2
Hooks Cut:	NO
Packaging:	PK-41815-001 TRAY

Ckts	Material No	Engineer Number
2	09-48-2028	A-41815-0509
3	09-48-2038	A-41815-0510
4	09-48-2048	A-41815-0511
5	09-48-2058	A-41815-0512
6	09-48-2068	A-41815-0513
7	09-48-2078	A-41815-0514
8	09-48-2088	A-41815-0515
9	09-48-2098	A-41815-0516
10	09-48-2108	A-41815-0517
11	09-48-2118	A-41815-0518
12	09-48-2128	A-41815-0519
13	09-48-2138	A-41815-0520
14	09-48-2148	A-41815-0521
15	09-48-2158	A-41815-0522

Material No	Engineer Number
09-48-5028	A-41815-0523
09-48-5038	A-41815-0524
09-48-5048	A-41815-0525
09-48-5058	A-41815-0526
09-48-5068	A-41815-0527
09-48-5078	A-41815-0528
09-48-5088	A-41815-0529
09-48-5098	A-41815-0530
09-48-5108	A-41815-0531
09-48-5118	A-41815-0532
09-48-5128	A-41815-0533
09-48-5138	A-41815-0534
09-48-5148	A-41815-0535
09-48-5158	A-41815-0536

Material No	Engineer Number
09-48-1025	A-41815-0537
09-48-1035	A-41815-0538
09-48-1045	A-41815-0539
09-48-1055	A-41815-0540
09-48-1065	A-41815-0541
09-48-1075	A-41815-0542
09-48-1085	A-41815-0543
09-48-1095	A-41815-0544
09-48-1105	A-41815-0545
09-48-1115	A-41815-0546
09-48-1125	A-41815-0547
09-48-1135	A-41815-0548
09-48-1145	A-41815-0549
09-48-1155	A-41815-0550

Material No	Engineer Number
41815-0551	41815-0551
41815-0552	41815-0552
41815-0553	41815-0553
41815-0554	41815-0554
41815-0555	41815-0555
41815-0556	41815-0556
41815-0557	41815-0557
41815-0558	41815-0558
41815-0559	41815-0559
41815-0560	41815-0560
41815-0561	41815-0561
41815-0562	41815-0562
41815-0563	41815-0563

AN3	REV:		ECR/ECN INFORMATION:		TITLE: KK 156 HOUSING ASSY PCB 41815 SERIES DWG	SHEET No.		
			EC NO.	UCP2015-1357		- 8 -		
			DATE:	11/10/2014				
DOCUMENT NUMBER:			CREATED / REVISED BY:		CHECKED BY:		APPROVED BY:	
SDA-41815			MKIPPER		NNGUYEN		FSMITH	



KK 156 PCB ASSY 2-15 CKT

41815 SERIES

	Assy. Proc:	BOTTOM ENTRY	Assy. Proc:	BOTTOM ENTRY	Assy. Proc:	RIGHT ANGLE	Assy. Proc:	TOP ENTRY
	Housing No:	41815-N-DN	Housing No:	41815-N-DN	Housing No:	41815-N-A15-7	Housing No:	41815-N-DN
	Options	WITHOUT RAMPS	Options	WITHOUT RAMPS	Options	WITH RAMP	Options	WITHOUT RAMP
	Terminal No:	6298-1-197	Terminal No:	6298-1-197	Terminal No:	2144-BA-A1AA-197B	Terminal No:	2144-BA-A1AA-197B
	Term Matl:	PHOS BRONZE	Term Matl:	PHOS BRONZE	Term Matl:	PHOS BRONZE	Term Matl:	PHOS BRONZE
	Plating:	197 – TIN	Plating:	197 – TIN	Plating:	197 – TIN	Plating:	197 – TIN
	Dim C:	3.18 / .125	Dim C:	3.18 / .125	Dim C:	(3.68) / .145	Dim C:	(3.05)/.120
	Voids:	NONE	Voids:	TERMINAL VOID 2	Voids:	TERMINAL VOID 7	Voids:	NONE
	Hooks Cut:	NO	Hooks Cut:	NO	Hooks Cut:	NO	Hooks Cut:	YES
	Packaging:	PK-41815-001 TRAY	Packaging:	PK-41815-001 TRAY	Packaging:	PK-41815-001 TRAY	Packaging:	PK-41815-001 TRAY
Ckts	Material No	Engineer Number	Material No	Engineer Number	Material No	Engineer Number	Material No	Engineer Number
2	41815-0564	A-41815-0564					41815-0601	A-41815-0601
3	41815-0565	A-41815-0565	41815-0579	A-41815-0579			41815-0602	A-41815-0602
4	41815-0566	A-41815-0566	41815-0580	A-41815-0580				
5	41815-0567	A-41815-0567	41815-0581	A-41815-0581				
6	41815-0568	A-41815-0568	41815-0582	A-41815-0582			41815-0605	A-41815-0605
7	41815-0569	A-41815-0569	41815-0583	A-41815-0583				
8	41815-0570	A-41815-0570	41815-0584	A-41815-0584				
9	41815-0571	A-41815-0571	41815-0585	A-41815-0585				
10	41815-0572	A-41815-0572	41815-0586	A-41815-0586				
11	41815-0573	A-41815-0573	41815-0587	A-41815-0587				
12	41815-0574	A-41815-0574	41815-0588	A-41815-0588				
13	41815-0575	A-41815-0575	41815-0589	A-41815-0589				
14	41815-0576	A-41815-0576	41815-0590	A-41815-0590				
15	41815-0577	A-41815-0577	41815-0591	A-41815-0591	41815-0600	A-41815-0600		

REV:	ECR/ECN INFORMATION:	TITLE:	SHEET No.
AN3	EC NO. UCP2015-1357	KK 156 HOUSING ASSY PCB 41815 SERIES DWG	- 9 -
	DATE: 11/10/2014		
DOCUMENT NUMBER: SDA-41815		CREATED / REVISED BY: MKIPPER	CHECKED BY: NNGUYEN
		APPROVED BY: FSMITH	



KK 156 PCB ASSY 2-15 CKT

41815 SERIES

	Assy. Proc:	RIGHT ANGLE	Assy. Proc:	TOP ENTRY	Assy. Proc:	RIGHT ANGLE	Assy. Proc:	BOTTOM ENTRY
	Housing No:	41815-N-DN	Housing No:	41815-N-DN	Housing No:	41815-N-AN	Housing No:	41815-N-DN
	Options	WITHOUT RAMP	Options	WITHOUT RAMP	Options	WITH RAMP	Options	WITHOUT RAMP
	Terminal No:	2144-BA-A1AA-197B	Terminal No:	2144-AA-A1AA-P909B	Terminal No:	2144-BA-A1AA-197B	Terminal No:	6298-197
	Term Matl:	PHOS BRONZE	Term Matl:	BRASS	Term Matl:	PHOS BRONZE	Term Matl:	PHOS BRONZE
	Plating:	197 – TIN	Plating:	P909 – TIN	Plating:	197 TIN	Plating:	197 – TIN
	Dim C:	(3.68) / .145	Dim C:	(3.05) / .120	Dim C:	(3.68) / .145	Dim C:	(4.60) / .160
	Voids:	NONE	Voids:	NONE	Voids:	TERMINAL VOID 2, 4	Voids:	NONE
	Hooks Cut:	NO	Hooks Cut:	YES	Hooks Cut:	NO	Hooks Cut:	YES
	Packaging:	PK-41815-001 TRAY	Packaging:	PK-41815-001 TRAY	Packaging:	PK-41815-001 TRAY	Packaging:	PK-41815-001 TRAY
Ckts	Material No	Engineer Number	Material No	Engineer Number	Material No	Engineer Number	Material No	Engineer Number
2	41815-0630	A-41815-0630					41815-0672	A-41815-0672
3	41815-0631	A-41815-0631						
4	41815-0632	A-41815-0632	41815-0646	A-41815-0646			41815-0674	A-41815-0674
5	41815-0633	A-41815-0633			41815-0661	A-41815-0661		
6	41815-0634	A-41815-0634						
7	41815-0635	A-41815-0635						
8	41815-0636	A-41815-0636						
9	41815-0637	A-41815-0637						
10	41815-0638	A-41815-0638						
11	41815-0639	A-41815-0639						
12	41815-0640	A-41815-0640						
13	41815-0641	A-41815-0641						
14	41815-0642	A-41815-0642						
15	41815-0643	A-41815-0643						

REV:	ECR/ECN INFORMATION:	TITLE:	SHEET No.
AN3	EC NO. UCP2015-1357	KK 156 HOUSING ASSY PCB 41815 SERIES DWG	- 10 -
	DATE: 11/10/2014		
DOCUMENT NUMBER: SDA-41815		CREATED / REVISED BY: MKIPPER	CHECKED BY: NNGUYEN
		APPROVED BY: FSMITH	



KK 156 PCB ASSY 2-15 CKT

41815 SERIES

	Assy. Proc:	RIGHT ANGLE	Assy. Proc:	Assy. Proc:	Assy. Proc:
	Housing No:	41815-N-AN	Housing No:	Housing No:	Housing No:
	Options	WITH RAMP	Options	Options	Options
	Terminal No:	2144-BA-A1AA-197B	Terminal No:	Terminal No:	Terminal No:
	Term Matl:	PHOS BRONZE	Term Matl:	Term Matl:	Term Matl:
	Plating:	197 TIN	Plating:	Plating:	Plating:
	Dim C:	(3.68) / .145	Dim C:	Dim C:	Dim C:
	Voids:	TERMINAL VOID 2	Voids:	Voids:	Voids:
	Hooks Cut:	NO	Hooks Cut:	Hooks Cut:	Hooks Cut:
	Packaging:	PK-41815-001 TRAY	Packaging:	Packaging:	Packaging:
Ckts	Material No	Engineer Number	Material No	Material No	Material No
2					
3	41815-0687	A-41815-0687			
4					
5					
6					
7					
8					
9					
10					
11					
12					
13					
14					
15					

REV:	ECR/ECN INFORMATION:	TITLE:	SHEET No.
AN3	EC NO. UCP2015-1357	KK 156 HOUSING ASSY PCB 41815 SERIES DWG	- 11 -
	DATE: 11/10/2014		
DOCUMENT NUMBER: SDA-41815		CREATED / REVISED BY: MKIPPER	CHECKED BY: NNGUYEN
		APPROVED BY: FSMITH	

(1.52±.05)
 .060±.002 DIA TYP
 CIRCUIT 1
 PCB LAYOUT: COMPONENT SIDE (1.57/.18)
 RECOMMENDED PCB THICKNESS: .062/.007

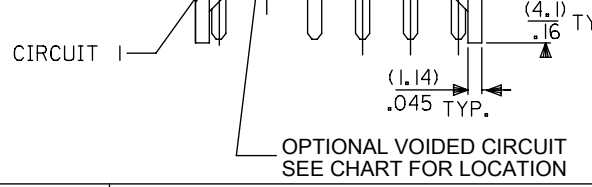
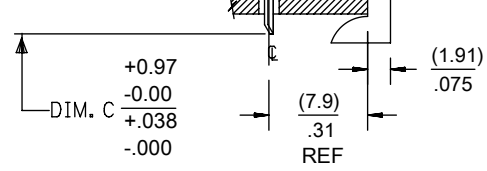

BOTTOM ENTRY

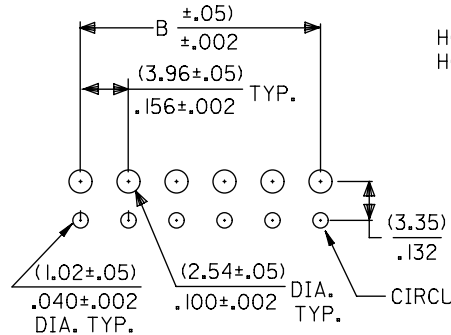

HOUSING: 41815-N-AN-** (WITH RAMP)
 HOUSING: 41815-N-DN-** (WITHOUT RAMP)

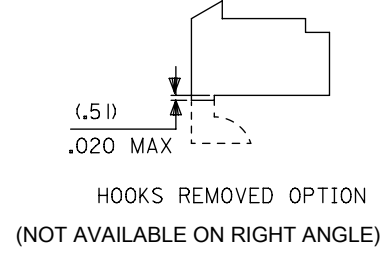
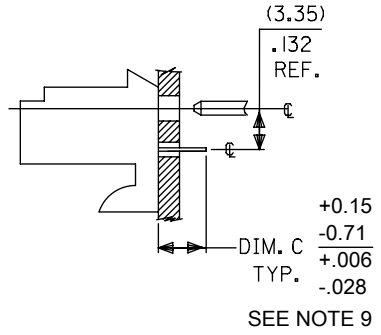

PCB LAYOUT: COMPONENT SIDE (1.57/.18)
 RECOMMENDED PCB THICKNESS: .062/.007

TOP ENTRY

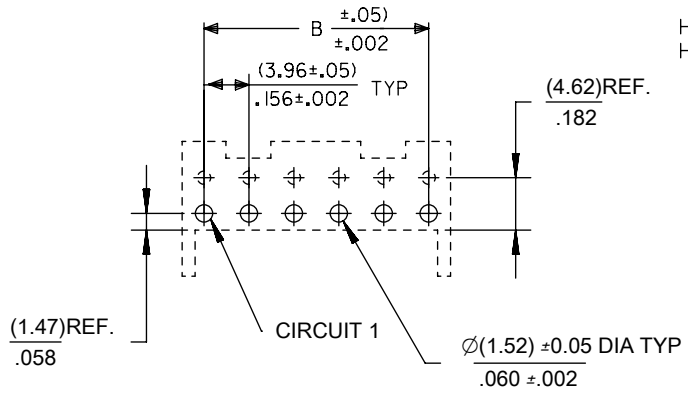

HOUSING: 41815-N-AN-** (WITH RAMP)
 HOUSING: 41815-N-DN-** (WITHOUT RAMP)

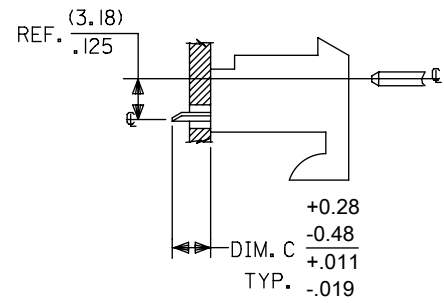

PCB LAYOUT: COMPONENT SIDE (1.57/.18)
 RECOMMENDED PCB THICKNESS: .062/.007

PRE-RELEASE
 REFERENCE
 USE ONLY

QUALITY SYMBOLS	THIS DRAWING CONTAINS INFORMATION	
▽ = 0	DIM C TOLERANCE EC NO: 107740 DRWN: MKIPPER CHKD: JBELL REV APPR:	GENERAL TOLERANCE (UNLESS SPECIFIED)
▽ = 0		4 PLACES ±
▽ = 0		3 PLACES ±
▼ = 0		2 PLACES ± 0.25
▽ = 0		1 PLACES ± 0.38
▽ = 0		0 PLACES ±
⊠ = 0		ANGULAR TOL ±
■ = 0		DRAFT WHERE APPLICABLE MUST REMAIN WITHIN DIMENSIONS
▽ = 0		AP
2016/08/22		2016/08/24

RELEASE STATUS	RELEASE DATE
----------------	--------------



KK 156 PCB ASSY 2-15 CKT

41815 SERIES

Assy. Proc:	RIGHT ANGLE
Housing No:	41815-N-AN
Options	WITH RAMP
Terminal No:	2144-BA-A1AA-197B
Term Matl:	PHOS BRONZE
Plating:	197 TIN
Dim C:	(3.68) / .145
Voids:	NONE
Hooks Cut:	NO
Packaging:	PK-41815-001 TRAY

Assy. Proc:	RIGHT ANGLE
Housing No:	41815-N-AN
Options	WITH RAMP
Terminal No:	2144-BA-A1AA-208B
Term Matl:	PHOS BRONZE
Plating:	208 – 15 GOLD
Dim C:	(3.68) / .145
Voids:	NONE
Hooks Cut:	NO
Packaging:	PK-41815-001 TRAY

Assy. Proc:	BOTTOM ENTRY
Housing No:	41815-N-AN
Options	WITH RAMP
Terminal No:	6298-1-197
Term Matl:	PHOS BRONZE
Plating:	197 – TIN
Dim C:	(3.18)/. 125
Voids:	NONE
Hooks Cut:	NO
Packaging:	PK-41815-001 TRAY

Assy. Proc:	BOTTOM ENTRY
Housing No:	41815-N-AN
Options	WITH RAMP
Terminal No:	6298-1-208
Term Matl:	PHOS BRONZE
Plating:	208 – 15 GOLD
Dim C:	(3.18)/. 125
Voids:	NONE
Hooks Cut:	NO
Packaging:	PK-41815-001 TRAY

Ckts	Material No	Engineer Number
2	09-48-1024	A-41815-0002
3	09-48-1034	A-41815-0003
4	09-48-1044	A-41815-0004
5	09-48-1054	A-41815-0005
6	09-48-1064	A-41815-0006
7	09-48-1074	A-41815-0007
8	09-48-1084	A-41815-0008
9	09-48-1094	A-41815-0009
10	09-48-1104	A-41815-0010
11	09-48-1114	A-41815-0011
12	09-48-1124	A-41815-0012
13	09-48-1134	A-41815-0013
14	09-48-1144	A-41815-0014
15	09-48-1154	A-41815-0015

Material No	Engineer Number
09-48-5024	A-41815-0016
09-48-5034	A-41815-0017
09-48-5044	A-41815-0018
09-48-5054	A-41815-0019
09-48-5064	A-41815-0020
09-48-5074	A-41815-0021
09-48-5084	A-41815-0022
09-48-5094	A-41815-0023
09-48-5104	A-41815-0024
09-48-5114	A-41815-0025
09-48-5124	A-41815-0026
09-48-5134	A-41815-0027
09-48-5144	A-41815-0028
09-48-5154	A-41815-0029

Material No	Engineer Number
09-48-4029	A-41815-0030
09-48-4039	A-41815-0031
09-48-4049	A-41815-0032
09-48-4059	A-41815-0033
09-48-4069	A-41815-0034
09-48-4079	A-41815-0035
09-48-4089	A-41815-0036
09-48-4099	A-41815-0037
09-48-4109	A-41815-0038
09-48-4119	A-41815-0039
09-48-4129	A-41815-0040
09-48-4139	A-41815-0041
09-48-4149	A-41815-0042
09-48-4159	A-41815-0043

Material No	Engineer Number
09-48-5026	A-41815-0044
09-48-5036	A-41815-0045
09-48-5046	A-41815-0046
09-48-5056	A-41815-0047
09-48-5066	A-41815-0048
09-48-5076	A-41815-0049
09-48-5086	A-41815-0050
09-48-5096	A-41815-0051
09-48-5106	A-41815-0052
09-48-5116	A-41815-0053
09-48-5126	A-41815-0054
09-48-5136	A-41815-0055
09-48-5146	A-41815-0056
09-48-5156	A-41815-0057

AN3	<u>REV:</u>		<u>ECR/ECN INFORMATION:</u>		<u>TITLE:</u>		<u>SHEET No.</u>	
			<u>EC NO.</u>	UCP2015-1357		KK 156 HOUSING ASSY PCB 41815 SERIES DWG		- 2 -
			<u>DATE:</u>	11/10/2014				
<u>DOCUMENT NUMBER:</u>			<u>CREATED / REVISED BY:</u>		<u>CHECKED BY:</u>		<u>APPROVED BY:</u>	
SDA-41815			MKIPPER		NNGUYEN		FSMITH	



KK 156 PCB ASSY 2-15 CKT

41815 SERIES

Ckts	Assy. Proc: TOP ENTRY		Assy. Proc: TOP ENTRY		Assy. Proc: BOTTOM ENTRY		Assy. Proc: TOP ENTRY	
	Material No	Engineer Number	Material No	Engineer Number	Material No	Engineer Number	Material No	Engineer Number
2	09-48-4028	A-41815-0058	09-48-5025	A-41815-0072	09-48-2022	A-41815-0100	09-48-2025	A-41815-0114
3	09-48-4038	A-41815-0059	09-48-5035	A-41815-0073	09-48-2032	A-41815-0101	09-48-2035	A-41815-0115
4	09-48-4048	A-41815-0060	09-48-5045	A-41815-0074	09-48-2042	A-41815-0102	09-48-2045	A-41815-0116
5	09-48-4058	A-41815-0061	09-48-5055	A-41815-0075	09-48-2052	A-41815-0103	09-48-2055	A-41815-0117
6	09-48-4068	A-41815-0062	09-48-5065	A-41815-0076	09-48-2062	A-41815-0104	09-48-2065	A-41815-0118
7	09-48-4078	A-41815-0063	09-48-5075	A-41815-0077	09-48-2072	A-41815-0105	09-48-2075	A-41815-0119
8	09-48-4088	A-41815-0064	09-48-5085	A-41815-0078	09-48-2082	A-41815-0106	09-48-2085	A-41815-0120
9	09-48-4098	A-41815-0065	09-48-5095	A-41815-0079	09-48-2092	A-41815-0107	09-48-2095	A-41815-0121
10	09-48-4108	A-41815-0066	09-48-5105	A-41815-0080	09-48-2102	A-41815-0108	09-48-2105	A-41815-0122
11	09-48-4118	A-41815-0067	09-48-5115	A-41815-0081	09-48-2112	A-41815-0109	09-48-2115	A-41815-0123
12	09-48-4128	A-41815-0068	09-48-5125	A-41815-0082	09-48-2122	A-41815-0110	09-48-2125	A-41815-0124
13	09-48-4138	A-41815-0069	09-48-5135	A-41815-0083	09-48-2132	A-41815-0111	09-48-2135	A-41815-0125
14	09-48-4148	A-41815-0070	09-48-5145	A-41815-0084	09-48-2142	A-41815-0112	09-48-2145	A-41815-0126
15	09-48-4158	A-41815-0071	09-48-5155	A-41815-0085	09-48-2152	A-41815-0113	09-48-2155	A-41815-0127

AN3	<u>REV:</u>		<u>ECR/ECN INFORMATION:</u>		KK 156 HOUSING ASSY PCB 41815 SERIES DWG			<u>SHEET No.</u>
			<u>EC NO.</u>	UCP2015-1357				- 3 -
			<u>DATE:</u>	11/10/2014				
<u>DOCUMENT NUMBER:</u>			<u>CREATED / REVISED BY:</u>		<u>CHECKED BY:</u>		<u>APPROVED BY:</u>	
SDA-41815			MKIPPER		NNGUYEN		FSMITH	



KK 156 PCB ASSY 2-15 CKT

41815 SERIES

	Assy. Proc:		Assy. Proc:	BOTTOM ENTRY	Assy. Proc:	BOTTOM ENTRY	Assy. Proc:	RIGHT ANGLE
	Housing No:		Housing No:	41815-N-AN	Housing No:	41815-N-AN	Housing No:	41815-N-AN
	Options		Options	WITH RAMP	Options	WITH RAMP	Options	WITH RAMP
	Terminal No:		Terminal No:	6298-197	Terminal No:	2188-1-228	Terminal No:	2144-AA-A1AA-P909B
	Term Matl:		Term Matl:	PHOS BRONZE	Term Matl:	BRASS	Term Matl:	BRASS
	Plating:		Plating:	197 – TIN	Plating:	228 – GOLD	Plating:	P909 – TIN
	Dim C:		Dim C:	(4.60) / .160	Dim C:	(3.18) / .125	Dim C:	(3.68) / .145
	Voids:		Voids:	NONE	Voids:	NONE	Voids:	NONE
	Hooks Cut:		Hooks Cut:	NO	Hooks Cut:	NO	Hooks Cut:	NO
	Packaging:		Packaging:	PK-41815-001 TRAY	Packaging:	PK-41815-001 TRAY	Packaging:	PK-41815-001 TRAY
Ckts	Material No	Engineer Number	Material No	Engineer Number	Material No	Engineer Number	Material No	Engineer Number
2			09-48-4021	A-41815-0170	41815-0184	A-41815-0184	09-48-2021	A-41815-0198
3			09-48-4031	A-41815-0171	09-48-5030	A-41815-0185	09-48-2031	A-41815-0199
4			09-48-4041	A-41815-0172	09-48-5040	A-41815-0186	09-48-2041	A-41815-0200
5			09-48-4051	A-41815-0173	09-48-5050	A-41815-0187	09-48-2051	A-41815-0201
6			09-48-4061	A-41815-0174	41815-0188	A-41815-0188	09-48-2061	A-41815-0202
7			09-48-4071	A-41815-0175	41815-0189	A-41815-0189	09-48-2071	A-41815-0203
8			09-48-4081	A-41815-0176	09-48-5080	A-41815-0190	09-48-2081	A-41815-0204
9			09-48-4091	A-41815-0177	41815-0191	A-41815-0191	09-48-2091	A-41815-0205
10			09-48-4101	A-41815-0178	09-48-5100	A-41815-0192	09-48-2101	A-41815-0206
11			09-48-4111	A-41815-0179	41815-0193	A-41815-0193	09-48-2111	A-41815-0207
12			09-48-4121	A-41815-0180	41815-0194	A-41815-0194	09-48-2121	A-41815-0208
13			09-48-4131	A-41815-0181	41815-0195	A-41815-0195	09-48-2131	A-41815-0209
14			09-48-4141	A-41815-0182	41815-0196	A-41815-0196	09-48-2141	A-41815-0210
15			09-48-4151	A-41815-0183	41815-0197	A-41815-0197	09-48-2151	A-41815-0211

REV:	ECR/ECN INFORMATION:	TITLE:	SHEET No.
AN3	EC NO. UCP2015-1357	KK 156 HOUSING ASSY PCB 41815 SERIES DWG	- 4 -
	DATE: 11/10/2014		
DOCUMENT NUMBER: SDA-41815		CREATED / REVISED BY: MKIPPER	CHECKED BY: NNGUYEN
		APPROVED BY: FSMITH	



KK 156 PCB ASSY 2-15 CKT

41815 SERIES

Assy. Proc:	TOP ENTRY
Housing No:	41815-N-AN
Options	WITH RAMP
Terminal No:	2144-AA-A1AA-P909B
Term Matl:	BRASS
Plating:	P909 – TIN
Dim C:	(3.05) / .120
Voids:	NONE
Hooks Cut:	NO
Packaging:	PK-41815-001 TRAY

Assy. Proc:	TOP ENTRY
Housing No:	41815-N-AN
Options	WITH RAMP
Terminal No:	2144-AA-A1AA-208B
Term Matl:	BRASS
Plating:	208 – 15 GOLD
Dim C:	(3.05) / .120
Voids:	NONE
Hooks Cut:	NO
Packaging:	PK-41815-001 TRAY

Assy. Proc:	RIGHT ANGLE
Housing No:	41815-N-AN
Options	WITH RAMP
Terminal No:	2144-BA-A1AA-P909B
Term Matl:	PHOS BRONZE
Plating:	P909 – TIN
Dim C:	(3.68) / .145
Voids:	NONE
Hooks Cut:	NO
Packaging:	PK-41815-001 TRAY

Assy. Proc:	BOTTOM ENTRY
Housing No:	41815-N-AN
Options	WITH RAMP
Terminal No:	6298-1-P909
Term Matl:	PHOS BRONZE
Plating:	P909 – TIN
Dim C:	(3.18) / .125
Voids:	NONE
Hooks Cut:	NO
Packaging:	PK-41815-001 TRAY

Ckts	Material No	Engineer Number
2	09-48-2023	A-41815-0453
3	09-48-2033	A-41815-0454
4	09-48-2043	A-41815-0455
5	09-48-2053	A-41815-0456
6	09-48-2063	A-41815-0457
7	09-48-2073	A-41815-0458
8	09-48-2083	A-41815-0459
9	09-48-2093	A-41815-0460
10	09-48-2103	A-41815-0461
11	09-48-2113	A-41815-0462
12	09-48-2123	A-41815-0463
13	09-48-2133	A-41815-0464
14	09-48-2143	A-41815-0465
15	09-48-2153	A-41815-0466

Material No	Engineer Number
09-48-3026	A-41815-0467
09-48-3036	A-41815-0468
09-48-3046	A-41815-0469
09-48-3056	A-41815-0470
09-48-3066	A-41815-0471
09-48-3076	A-41815-0472
09-48-3086	A-41815-0473
09-48-3096	A-41815-0474
09-48-3106	A-41815-0475
09-48-3116	A-41815-0476
09-48-3126	A-41815-0477
09-48-3136	A-41815-0478
09-48-3146	A-41815-0479
09-48-3156	A-41815-0480

Material No	Engineer Number
09-48-2020	A-41815-0481
09-48-2030	A-41815-0482
09-48-2040	A-41815-0483
09-48-2050	A-41815-0484
09-48-2060	A-41815-0485
09-48-2070	A-41815-0486
09-48-2080	A-41815-0487
09-48-2090	A-41815-0488
09-48-2100	A-41815-0489
09-48-2110	A-41815-0490
09-48-2120	A-41815-0491
09-48-2130	A-41815-0492
09-48-2140	A-41815-0493
09-48-2150	A-41815-0494

Material No	Engineer Number
09-48-2029	A-41815-0495
09-48-2039	A-41815-0496
09-48-2049	A-41815-0497
09-48-2059	A-41815-0498
09-48-2069	A-41815-0499
09-48-2079	A-41815-0500
09-48-2089	A-41815-0501
09-48-2099	A-41815-0502
09-48-2109	A-41815-0503
09-48-2119	A-41815-0504
09-48-2129	A-41815-0505
09-48-2139	A-41815-0506
09-48-2149	A-41815-0507
09-48-2159	A-41815-0508

AN3	<u>REV:</u>		<u>ECR/ECN INFORMATION:</u>		<u>TITLE:</u>		<u>SHEET No.</u>	
			<u>EC NO.</u>	UCP2015-1357		KK 156 HOUSING ASSY PCB		- 7 -
			<u>DATE:</u>	11/10/2014		41815 SERIES DWG		
<u>DOCUMENT NUMBER:</u>			<u>CREATED / REVISED BY:</u>		<u>CHECKED BY:</u>		<u>APPROVED BY:</u>	
SDA-41815			MKIPPER		NNGUYEN		FSMITH	



KK 156 PCB ASSY 2-15 CKT

41815 SERIES

Assy. Proc:	TOP ENTRY
Housing No:	41815-N-AN
Options	WITH RAMP
Terminal No:	2144-BA-A1AA-P909B
Term Matl:	PHOS BRONZE
Plating:	P909 – TIN
Dim C:	(3.05) / .120
Voids:	NONE
Hooks Cut:	NO
Packaging:	PK-41815-001 TRAY

Assy. Proc:	TOP ENTRY
Housing No:	41815-N-AN
Options	WITH RAMP
Terminal No:	2144-BA-A1AA-197B
Term Matl:	PHOS BRONZE
Plating:	197 – TIN
Dim C:	(3.05) / .120
Voids:	NONE
Hooks Cut:	YES
Packaging:	PK-41815-001 TRAY

Assy. Proc:	TOP ENTRY
Housing No:	41815-N-AN
Options	WITH RAMP
Terminal No:	2144-BA-A1AA-208B
Term Matl:	PHOS BRONZE
Plating:	208 – 15 GOLD
Dim C:	(3.05) / .120
Voids:	NONE
Hooks Cut:	YES
Packaging:	PK-41815-001 TRAY

Assy. Proc:	BOTTOM ENTRY
Housing No:	41815-N-AN
Options	WITH RAMP
Terminal No:	2188-1-208
Term Matl:	BRASS
Plating:	208 – 15 GOLD
Dim C:	(3.18) / .125
Voids:	TERMINAL VOID 2
Hooks Cut:	NO
Packaging:	PK-41815-001 TRAY

Ckts	Material No	Engineer Number
2	09-48-2028	A-41815-0509
3	09-48-2038	A-41815-0510
4	09-48-2048	A-41815-0511
5	09-48-2058	A-41815-0512
6	09-48-2068	A-41815-0513
7	09-48-2078	A-41815-0514
8	09-48-2088	A-41815-0515
9	09-48-2098	A-41815-0516
10	09-48-2108	A-41815-0517
11	09-48-2118	A-41815-0518
12	09-48-2128	A-41815-0519
13	09-48-2138	A-41815-0520
14	09-48-2148	A-41815-0521
15	09-48-2158	A-41815-0522

Material No	Engineer Number
09-48-5028	A-41815-0523
09-48-5038	A-41815-0524
09-48-5048	A-41815-0525
09-48-5058	A-41815-0526
09-48-5068	A-41815-0527
09-48-5078	A-41815-0528
09-48-5088	A-41815-0529
09-48-5098	A-41815-0530
09-48-5108	A-41815-0531
09-48-5118	A-41815-0532
09-48-5128	A-41815-0533
09-48-5138	A-41815-0534
09-48-5148	A-41815-0535
09-48-5158	A-41815-0536

Material No	Engineer Number
09-48-1025	A-41815-0537
09-48-1035	A-41815-0538
09-48-1045	A-41815-0539
09-48-1055	A-41815-0540
09-48-1065	A-41815-0541
09-48-1075	A-41815-0542
09-48-1085	A-41815-0543
09-48-1095	A-41815-0544
09-48-1105	A-41815-0545
09-48-1115	A-41815-0546
09-48-1125	A-41815-0547
09-48-1135	A-41815-0548
09-48-1145	A-41815-0549
09-48-1155	A-41815-0550

Material No	Engineer Number
41815-0551	41815-0551
41815-0552	41815-0552
41815-0553	41815-0553
41815-0554	41815-0554
41815-0555	41815-0555
41815-0556	41815-0556
41815-0557	41815-0557
41815-0558	41815-0558
41815-0559	41815-0559
41815-0560	41815-0560
41815-0561	41815-0561
41815-0562	41815-0562
41815-0563	41815-0563

AN3	<u>REV:</u>		<u>ECR/ECN INFORMATION:</u>		<u>TITLE:</u>			<u>SHEET No.</u>	
			<u>EC NO.</u>	UCP2015-1357		KK 156 HOUSING ASSY PCB 41815 SERIES DWG			- 8 -
			<u>DATE:</u>	11/10/2014					
<u>DOCUMENT NUMBER:</u>					<u>CREATED / REVISED BY:</u>		<u>CHECKED BY:</u>		<u>APPROVED BY:</u>
SDA-41815					MKIPPER		NNGUYEN		FSMITH



KK 156 PCB ASSY 2-15 CKT

41815 SERIES

	Assy. Proc:	BOTTOM ENTRY	Assy. Proc:	BOTTOM ENTRY	Assy. Proc:	RIGHT ANGLE	Assy. Proc:	TOP ENTRY
	Housing No:	41815-N-DN	Housing No:	41815-N-DN	Housing No:	41815-N-A15-7	Housing No:	41815-N-DN
	Options	WITHOUT RAMPS	Options	WITHOUT RAMPS	Options	WITH RAMP	Options	WITHOUT RAMP
	Terminal No:	6298-1-197	Terminal No:	6298-1-197	Terminal No:	2144-BA-A1AA-197B	Terminal No:	2144-BA-A1AA-197B
	Term Matl:	PHOS BRONZE	Term Matl:	PHOS BRONZE	Term Matl:	PHOS BRONZE	Term Matl:	PHOS BRONZE
	Plating:	197 – TIN	Plating:	197 – TIN	Plating:	197 – TIN	Plating:	197 – TIN
	Dim C:	3.18 / .125	Dim C:	3.18 / .125	Dim C:	(3.68) / .145	Dim C:	(3.05)/.120
	Voids:	NONE	Voids:	TERMINAL VOID 2	Voids:	TERMINAL VOID 7	Voids:	NONE
	Hooks Cut:	NO	Hooks Cut:	NO	Hooks Cut:	NO	Hooks Cut:	YES
	Packaging:	PK-41815-001 TRAY	Packaging:	PK-41815-001 TRAY	Packaging:	PK-41815-001 TRAY	Packaging:	PK-41815-001 TRAY
Ckts	Material No	Engineer Number	Material No	Engineer Number	Material No	Engineer Number	Material No	Engineer Number
2	41815-0564	A-41815-0564					41815-0601	A-41815-0601
3	41815-0565	A-41815-0565	41815-0579	A-41815-0579			41815-0602	A-41815-0602
4	41815-0566	A-41815-0566	41815-0580	A-41815-0580				
5	41815-0567	A-41815-0567	41815-0581	A-41815-0581				
6	41815-0568	A-41815-0568	41815-0582	A-41815-0582			41815-0605	A-41815-0605
7	41815-0569	A-41815-0569	41815-0583	A-41815-0583				
8	41815-0570	A-41815-0570	41815-0584	A-41815-0584				
9	41815-0571	A-41815-0571	41815-0585	A-41815-0585				
10	41815-0572	A-41815-0572	41815-0586	A-41815-0586				
11	41815-0573	A-41815-0573	41815-0587	A-41815-0587				
12	41815-0574	A-41815-0574	41815-0588	A-41815-0588				
13	41815-0575	A-41815-0575	41815-0589	A-41815-0589				
14	41815-0576	A-41815-0576	41815-0590	A-41815-0590				
15	41815-0577	A-41815-0577	41815-0591	A-41815-0591	41815-0600	A-41815-0600		

REV: AN3	ECR/ECN INFORMATION:		TITLE: KK 156 HOUSING ASSY PCB 41815 SERIES DWG	<u>SHEET No.</u>
	EC NO.	UCP2015-1357		- 9 -
	DATE:	11/10/2014		
DOCUMENT NUMBER: SDA-41815		CREATED / REVISED BY: MKIPPER	CHECKED BY: NNGUYEN	APPROVED BY: FSMITH



KK 156 PCB ASSY 2-15 CKT

41815 SERIES

	Assy. Proc:	RIGHT ANGLE	Assy. Proc:	TOP ENTRY	Assy. Proc:	RIGHT ANGLE	Assy. Proc:	BOTTOM ENTRY
	Housing No:	41815-N-DN	Housing No:	41815-N-DN	Housing No:	41815-N-AN	Housing No:	41815-N-DN
	Options	WITHOUT RAMP	Options	WITHOUT RAMP	Options	WITH RAMP	Options	WITHOUT RAMP
	Terminal No:	2144-BA-A1AA-197B	Terminal No:	2144-AA-A1AA-P909B	Terminal No:	2144-BA-A1AA-197B	Terminal No:	6298-197
	Term Matl:	PHOS BRONZE	Term Matl:	BRASS	Term Matl:	PHOS BRONZE	Term Matl:	PHOS BRONZE
	Plating:	197 – TIN	Plating:	P909 – TIN	Plating:	197 TIN	Plating:	197 – TIN
	Dim C:	(3.68) / .145	Dim C:	(3.05) / .120	Dim C:	(3.68) / .145	Dim C:	(4.60) / .160
	Voids:	NONE	Voids:	NONE	Voids:	TERMINAL VOID 2, 4	Voids:	NONE
	Hooks Cut:	NO	Hooks Cut:	YES	Hooks Cut:	NO	Hooks Cut:	YES
	Packaging:	PK-41815-001 TRAY	Packaging:	PK-41815-001 TRAY	Packaging:	PK-41815-001 TRAY	Packaging:	PK-41815-001 TRAY
Ckts	Material No	Engineer Number	Material No	Engineer Number	Material No	Engineer Number	Material No	Engineer Number
2	41815-0630	A-41815-0630					41815-0672	A-41815-0672
3	41815-0631	A-41815-0631						
4	41815-0632	A-41815-0632	41815-0646	A-41815-0646			41815-0674	A-41815-0674
5	41815-0633	A-41815-0633			41815-0661	A-41815-0661		
6	41815-0634	A-41815-0634						
7	41815-0635	A-41815-0635						
8	41815-0636	A-41815-0636						
9	41815-0637	A-41815-0637						
10	41815-0638	A-41815-0638						
11	41815-0639	A-41815-0639						
12	41815-0640	A-41815-0640						
13	41815-0641	A-41815-0641						
14	41815-0642	A-41815-0642						
15	41815-0643	A-41815-0643						

REV:	ECR/ECN INFORMATION:	TITLE:	SHEET No.
AN3	EC NO. UCP2015-1357	KK 156 HOUSING ASSY PCB 41815 SERIES DWG	- 10 -
	DATE: 11/10/2014		
DOCUMENT NUMBER: SDA-41815		CREATED / REVISED BY: MKIPPER	CHECKED BY: NNGUYEN
		APPROVED BY: FSMITH	



KK 156 PCB ASSY 2-15 CKT

41815 SERIES

	Assy. Proc:	RIGHT ANGLE	Assy. Proc:	Assy. Proc:	Assy. Proc:
	Housing No:	41815-N-AN	Housing No:	Housing No:	Housing No:
	Options	WITH RAMP	Options	Options	Options
	Terminal No:	2144-BA-A1AA-197B	Terminal No:	Terminal No:	Terminal No:
	Term Matl:	PHOS BRONZE	Term Matl:	Term Matl:	Term Matl:
	Plating:	197 TIN	Plating:	Plating:	Plating:
	Dim C:	(3.68) / .145	Dim C:	Dim C:	Dim C:
	Voids:	TERMINAL VOID 2	Voids:	Voids:	Voids:
	Hooks Cut:	NO	Hooks Cut:	Hooks Cut:	Hooks Cut:
	Packaging:	PK-41815-001 TRAY	Packaging:	Packaging:	Packaging:
Ckts	Material No	Engineer Number	Material No	Material No	Engineer Number
2					
3	41815-0687	A-41815-0687			
4					
5					
6					
7					
8					
9					
10					
11					
12					
13					
14					
15					

REV:	ECR/ECN INFORMATION:	TITLE:	SHEET No.
AN3	EC NO. UCP2015-1357	KK 156 HOUSING ASSY PCB 41815 SERIES DWG	- 11 -
	DATE: 11/10/2014		
DOCUMENT NUMBER:		CREATED / REVISED BY:	CHECKED BY:
SDA-41815		MKIPPER	NNGUYEN
		APPROVED BY:	
		FSMITH	

X-ON Electronics

Largest Supplier of Electrical and Electronic Components

Click to view similar products for [Headers & Wire Housings](#) category:

Click to view products by [Molex](#) manufacturer:

Other Similar products are found below :

[95000-104TRLF](#) [10135584-644402LF](#) [DF62W-EP2022PCA](#) [95000-106TRLF](#) [DF62W-2022SCA](#) [DF62W-EP2022PC](#) [2203348](#) [DF62W-2022SC](#) [1084018](#) [1029039](#) [1084017](#) [802-10-012-10-002000](#) [1112640](#) [1112639](#) [891-007-9SS-BST1T](#) [000-34000](#) [0008550134](#) [0009482033](#) [0009507031](#) [57102-F02-18ULF](#) [57102-S06-03LF](#) [57202-S52-04LF](#) [PCN6-15S-2.5E](#) [0039019024](#) [58102-G61-06LF](#) [582553-1](#) [0009485154](#) [0009508121](#) [009176003701906](#) [0022285053](#) [0050291907](#) [018731A](#) [LY20-4P-DT1-P1E-BR](#) [02.125.8002.8](#) [60101931](#) [60598-1 \(Cut Strip\)](#) [M1625-3R/100](#) [61062-3](#) [61082-181009](#) [CSU011177004](#) [636-1427](#) [638009-1](#) [641938-9](#) [641991-4](#) [644168-1](#) [644827-2](#) [647662-1](#) [65039-019ELF](#) [65692-001LF](#) [65781-018](#)