



Data and signal line chokes

Common-mode chokes, ring core
0.005 ... 4.7 mH, 200 ... 1000 mA, 60 °C

Series/Type: B82790C0/S0

Date: April 2008

SMD

Rated voltage 42 V AC/80 V DC
Rated inductance 0.005 mH to 4.7 mH
Rated current 200 mA to 1000 mA

Construction

- Current-compensated ring core double choke
- Ferrite core
- PPS case (UL 94 V-0)
- Bifilar winding (B82790C0)
- Sector winding (B82790S0)

Features

- Suitable for reflow soldering
- Qualified to AEC-Q200
- RoHS-compatible

Function

- B82790C0:
Suppression of asymmetrical interference coupled in on lines, whereas data signals up to some MHz can pass unaffectedly.
- B82790S0:
Suppression of asymmetrical and symmetrical interference (by L_{stray}) coupled in on lines. The high-frequency portions of the symmetrical data signal are decreased so far that EMC problems can be significantly reduced.

Applications

- Automotive applications, e.g. CAN bus
- Industrial applications

Terminals

- Base material CuSn6
- Layer composition Ni, Sn
- Electro-plated

Marking

- Marking on component: Manufacturer, process location (coded), winding method (coded), ordering code (short form), date of manufacture (YWWDD)
- Minimum data on reel: Manufacturer, ordering code, L value and tolerance, quantity, date of packing

Delivery mode and packing unit

- 16-mm blister tape, wound on 330-mm \varnothing reel
- Packing unit: 1500 pcs./reel

SMD

Dimensional drawing and pin configuration

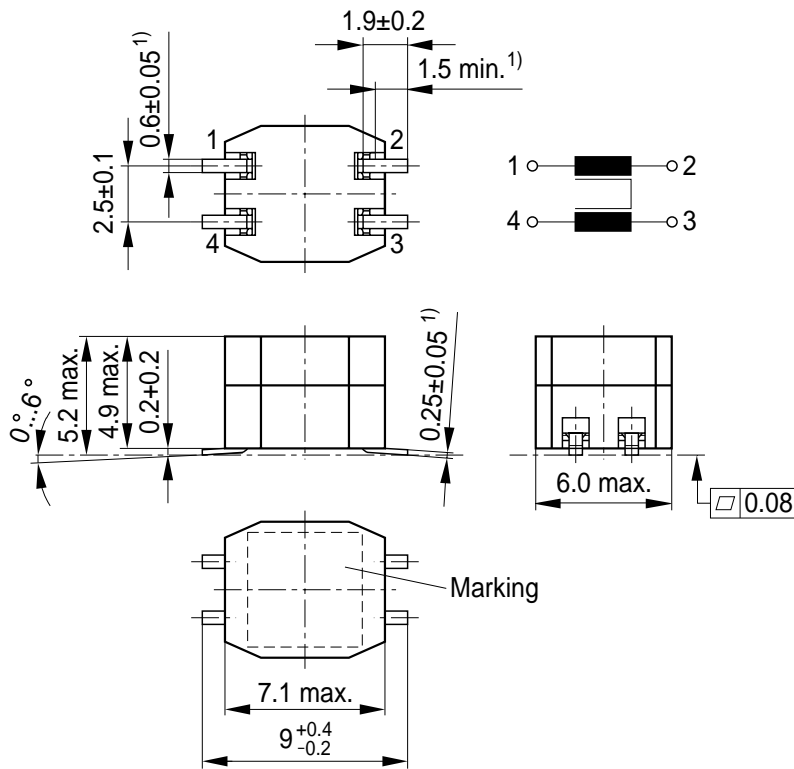

Layout recommendation

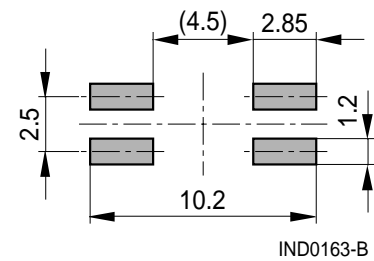

1) Soldering area

IND0009-B-E

Dimensions in mm

Taping and packing

Blister tape

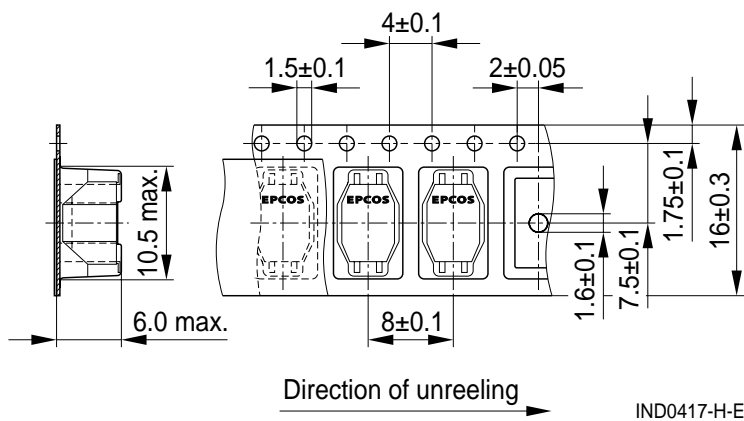

IND0417-H-E

Reel

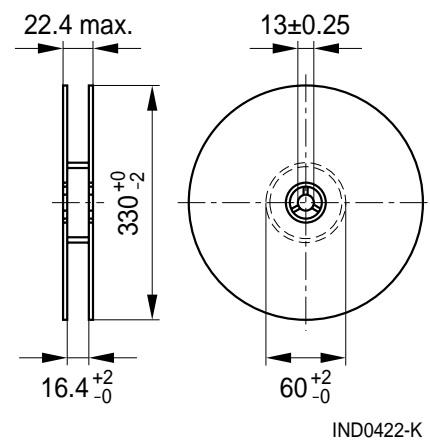

Dimensions in mm

SMD
Technical data and measuring conditions

Rated voltage V_R	42 V AC (50/60 Hz) / 80 V DC
Rated temperature T_R	60 °C
Rated current I_R	Referred to 50 Hz and rated temperature
Rated inductance L_R	Measured with Agilent 4284A at 0.1 mA, 20 °C Measuring frequency: $L_R \leq 1$ mH = 100 kHz $L_R > 1$ mH = 10 kHz Inductance is specified per winding.
Inductance tolerance	$\pm 30\%$ ($L_R \leq 0.47$ mH), $-30/+50\%$ ($L_R \geq 1$ mH) at 20 °C
Inductance decrease $\Delta L/L_0$	$< 10\%$ at DC magnetic bias with I_R , 20 °C
Stray inductance $L_{\text{stray,typ}}$	Measured with Agilent 4284A at 5 mA, 20 °C, typ. values Measuring frequency: $L_R \leq 11$ μ H = 1 MHz $L_R > 11$ μ H = 100 kHz
DC resistance R_{typ}	Measured at 20 °C, typical values, specified per winding
Solderability	SnPb: (215 \pm 3) °C, (3 \pm 0.3) s Sn96.5Ag3.0Cu0.5: (245 \pm 5) °C, (3 \pm 0.3) s Wetting of soldering area $\geq 95\%$ (to IEC 60068-2-58)
Resistance to soldering heat	(260 \pm 5) °C, (10 \pm 1) s (to IEC 60068-2-58)
Climatic category	40/125/56 (to IEC 60068-1)
Storage conditions (packaged)	-25 °C ... +40 °C, $\leq 75\%$ RH
Weight	Approx. 0.3 g

Characteristics and ordering codes

L_R mH	$L_{\text{stray,typ}}$ nH	I_R mA	R_{typ} m Ω	V_{test} V DC, 2 s	Ordering code
0.005	40	1000	60	250	B82790C0502N201
0.011	50	500	80	250	B82790C0113N201
0.025	60	500	110	250	B82790C0253N201
0.025	1400	500	110	250	B82790S0253N201
0.051	70	500	140	250	B82790C0513N201
0.051	2100	500	140	250	B82790S0513N201
0.470	100	500	170	250	B82790C0474N215
1.0	100	500	170	250	B82790C0105N240
2.2	200	400	400	250	B82790C0225N265
4.7	300	200	510	250	B82790C0475N265

Types with $L_R \geq 0.47$ mH:

750 V DC possible for soldering process with Pb containing solder material.

For lead-free soldering please use series B82793.

Sample kit available. Ordering code: B82790X001

For more information refer to chapter "Sample kits".

SMD

Insertion loss α (typical values at $|Z| = 50 \Omega$, 20 °C)

———— asymmetrical, all branches in parallel (common mode)

- - - - - symmetrical (differential mode)

$L_R = 0.005 \text{ mH}$

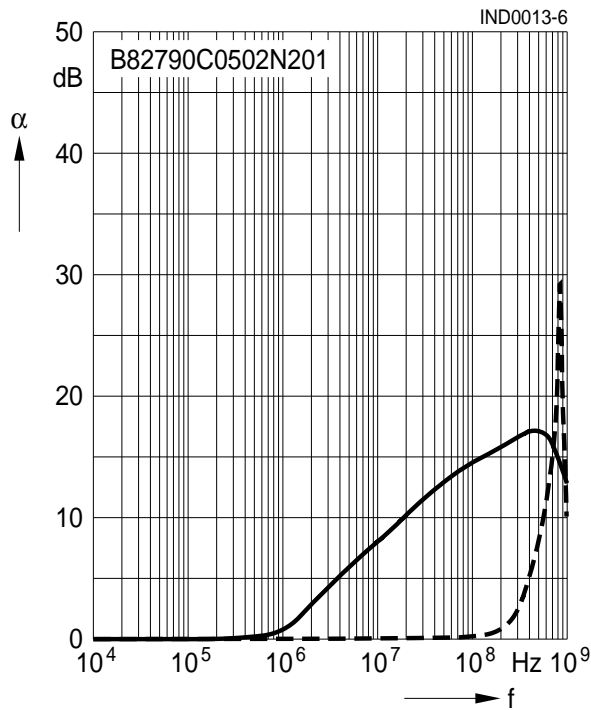

$L_R = 0.011 \text{ mH}$

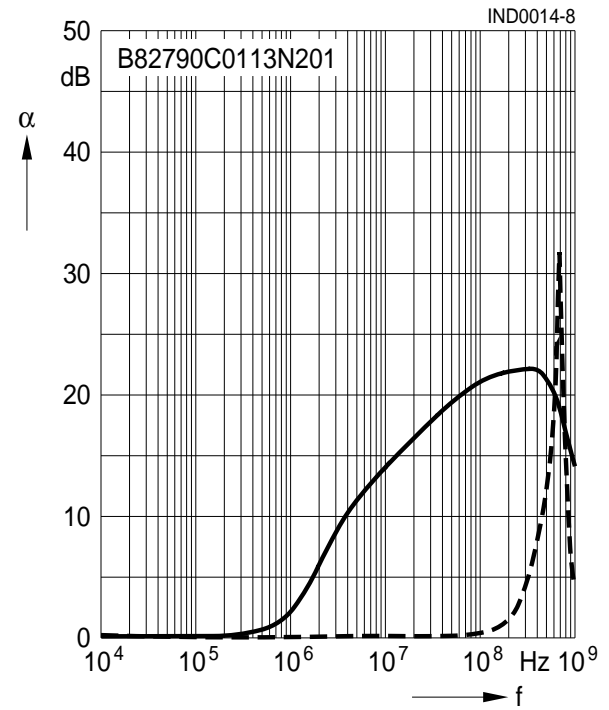

$L_R = 0.025 \text{ mH (low } L_{\text{stray}})$

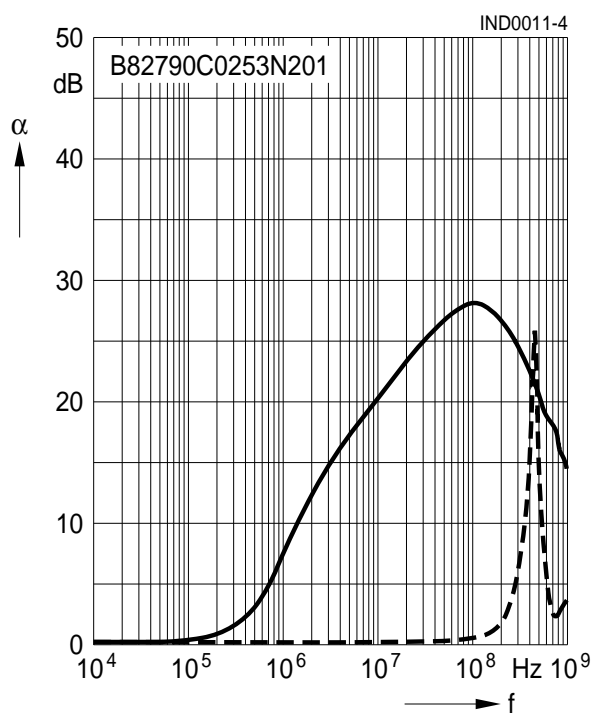

$L_R = 0.025 \text{ mH (high } L_{\text{stray}})$

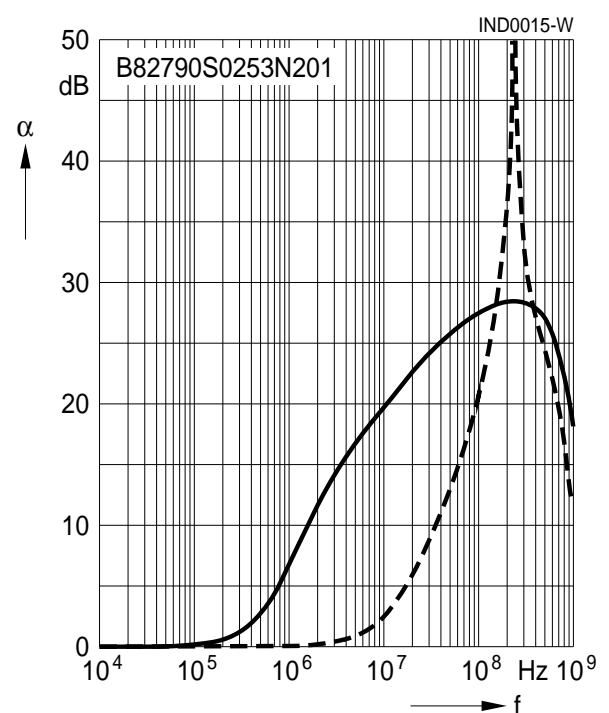

SMD

Insertion loss α (typical values at $|Z| = 50 \Omega$, 20°C)

———— asymmetrical, all branches in parallel (common mode)

- - - - - symmetrical (differential mode)

$L_R = 0.051 \text{ mH}$ (low L_{stray})

$L_R = 0.051 \text{ mH}$ (high L_{stray})

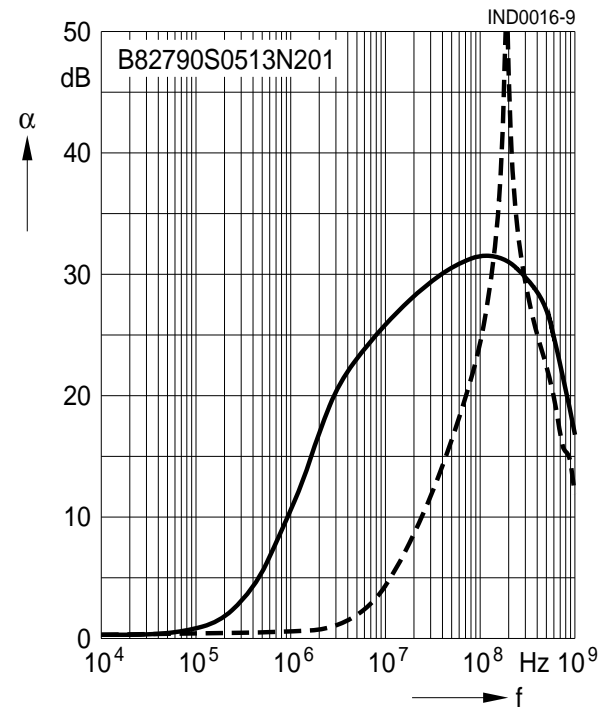
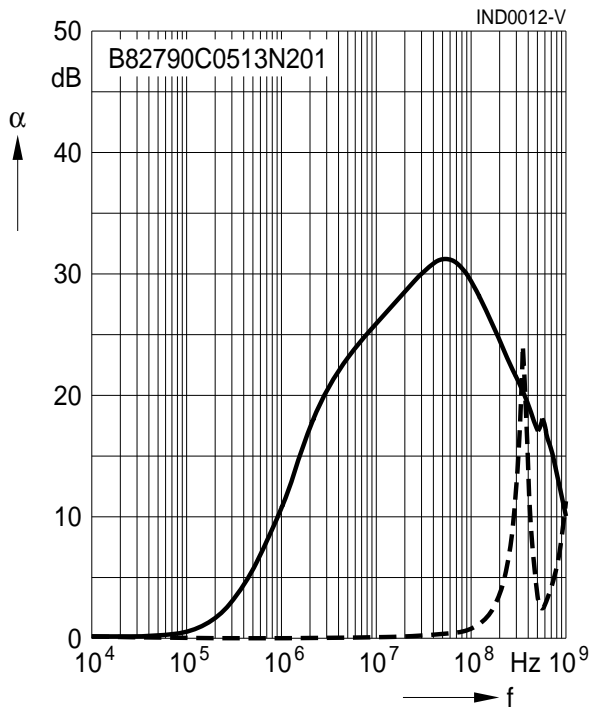

$L_R = 0.47 \text{ mH}$

$L_R = 1.0 \text{ mH}$

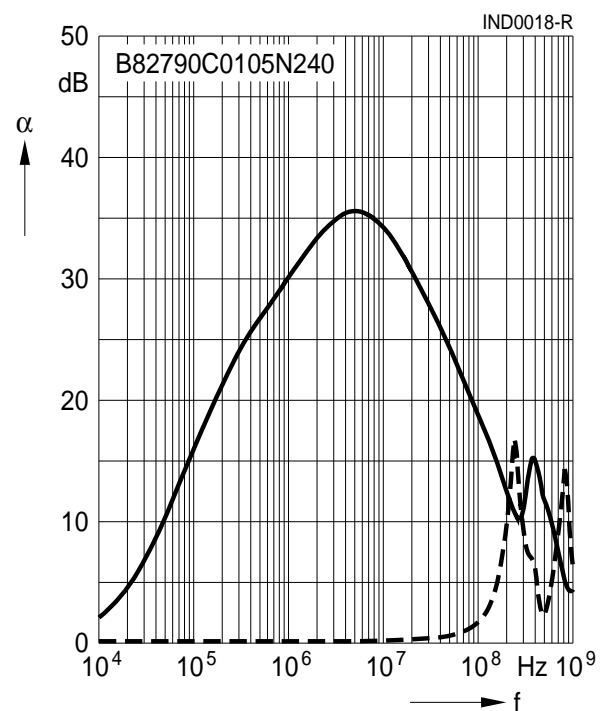
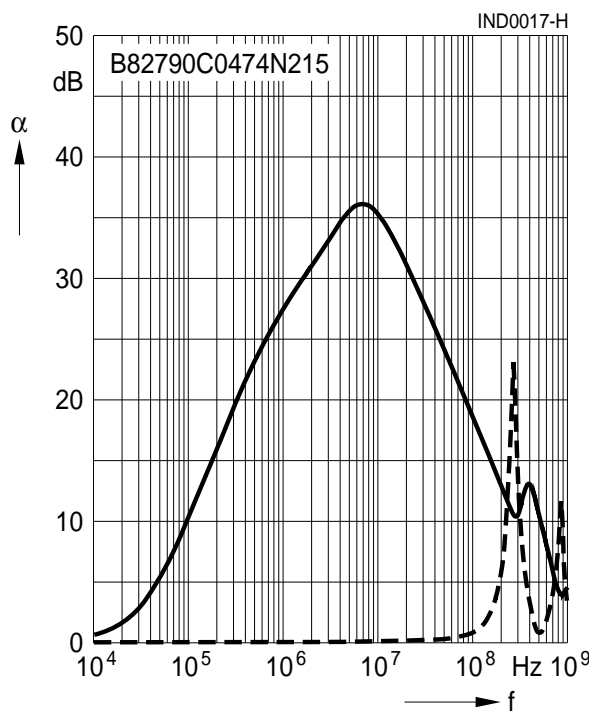

SMD

Insertion loss α (typical values at $|Z| = 50 \Omega$, 20°C)

———— asymmetrical, all branches in parallel (common mode)

- - - - - symmetrical (differential mode)

$L_R = 2.2 \text{ mH}$

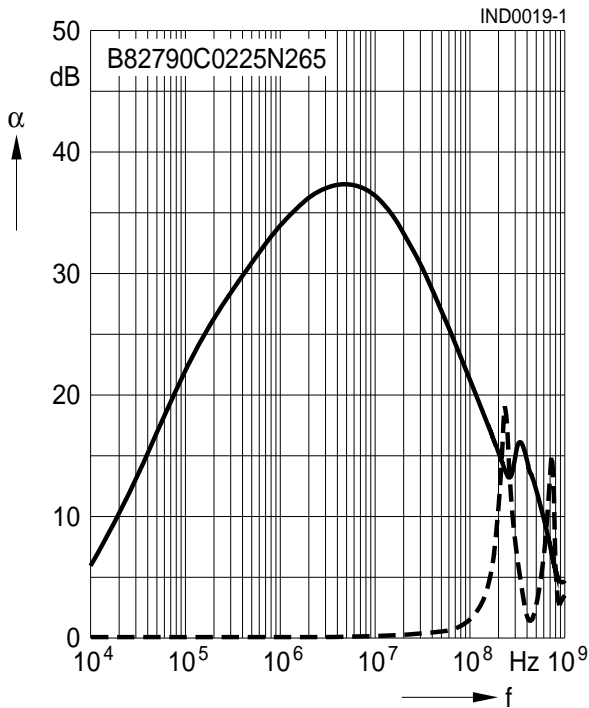

$L_R = 4.7 \text{ mH}$

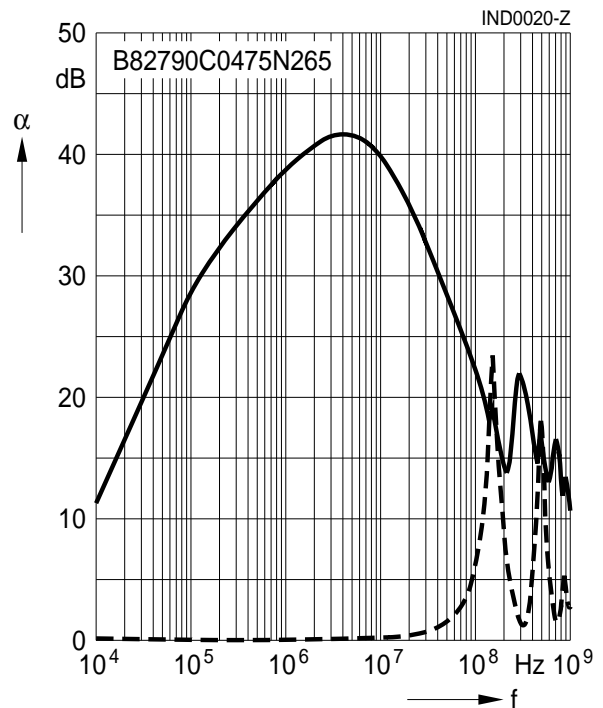

Current derating I_{op}/I_R versus ambient temperature

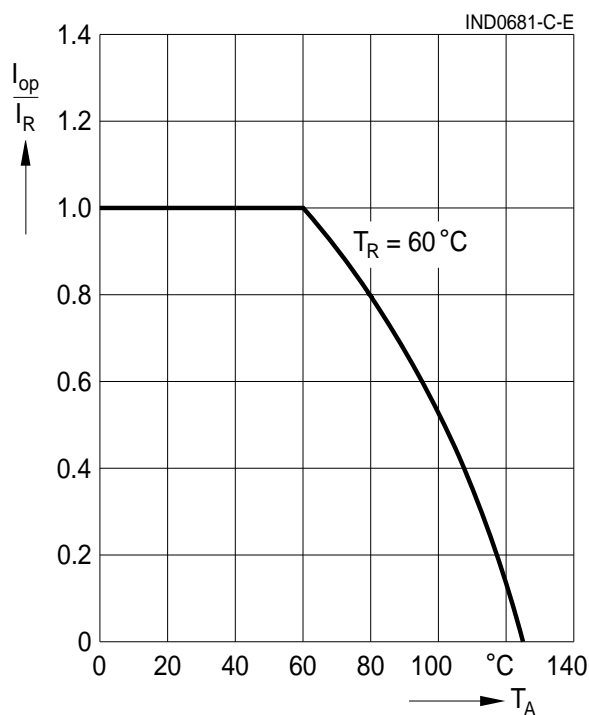

SMD

Recommended reflow soldering curve

Pb containing solder material (based on CECC 00802 edition 2)

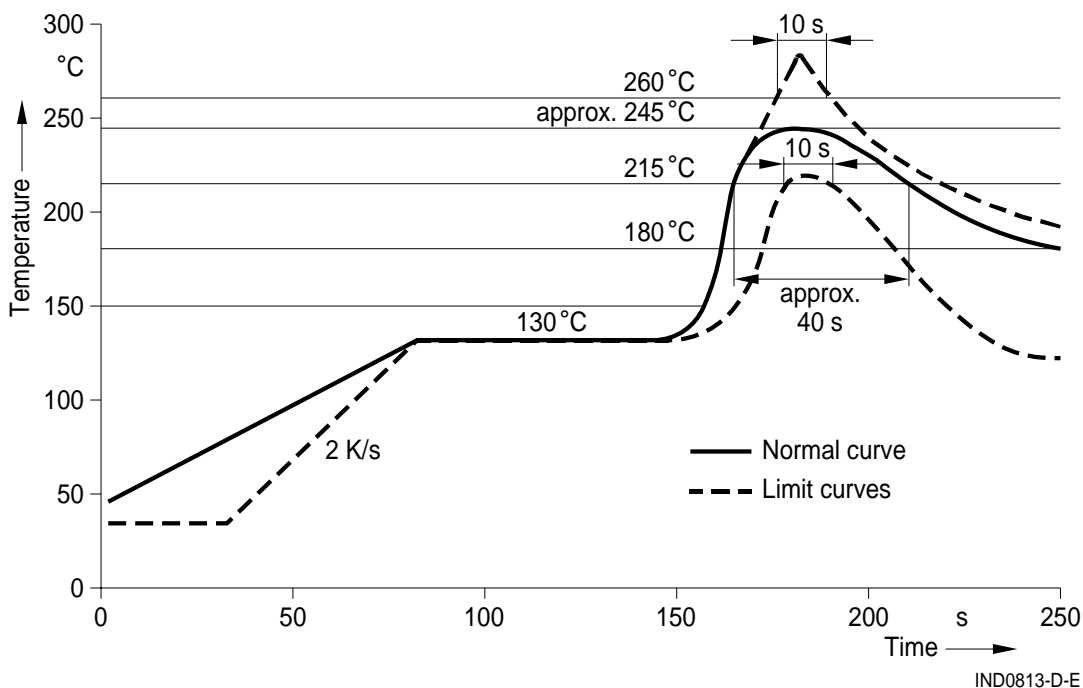

Pb-free solder material (based on JEDEC J-STD 020C)

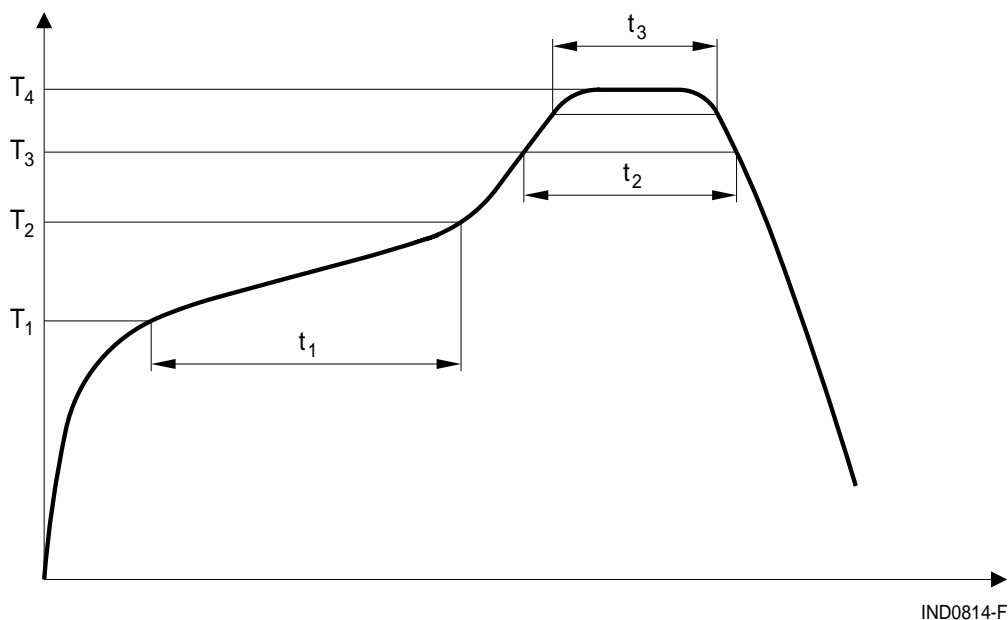

T ₁ °C	T ₂ °C	T ₃ °C	T ₄ °C	t ₁ s	t ₂ s	t ₃ s
150	200	217	250	< 110	< 90	< 30 @ T ₄ -5 °C

Time from 25 °C to T₄: max 300 s

Maximal numbers of reflow cycles: 3

Please read *Cautions and warnings* and *Important notes* at the end of this document.

Cautions and warnings

- Please note the recommendations in our Inductors data book (latest edition) and in the data sheets.
 - Particular attention should be paid to the derating curves given there.
 - The soldering conditions should also be observed. Temperatures quoted in relation to wave soldering refer to the pin, not the housing.
- If the components are to be washed varnished it is necessary to check whether the washing varnish agent that is used has a negative effect on the wire insulation, any plastics that are used, or on glued joints. In particular, it is possible for washing varnish agent residues to have a negative effect in the long-term on wire insulation.
- The following points must be observed if the components are potted in customer applications:
 - Many potting materials shrink as they harden. They therefore exert a pressure on the plastic housing or core. This pressure can have a deleterious effect on electrical properties, and in extreme cases can damage the core or plastic housing mechanically.
 - It is necessary to check whether the potting material used attacks or destroys the wire insulation, plastics or glue.
 - The effect of the potting material can change the high-frequency behaviour of the components.
- Ferrites are sensitive to direct impact. This can cause the core material to flake, or lead to breakage of the core.
- Even for customer-specific products, conclusive validation of the component in the circuit can only be carried out by the customer.

Important notes

The following applies to all products named in this publication:

1. Some parts of this publication contain **statements about the suitability of our products for certain areas of application**. These statements are based on our knowledge of typical requirements that are often placed on our products in the areas of application concerned. We nevertheless expressly point out **that such statements cannot be regarded as binding statements about the suitability of our products for a particular customer application**.

As a rule, EPCOS is either unfamiliar with individual customer applications or less familiar with them than the customers themselves. For these reasons, it is always ultimately incumbent on the customer to check and decide whether an EPCOS product with the properties described in the product specification is suitable for use in a particular customer application.

2. We also point out that **in individual cases, a malfunction of electronic components or failure before the end of their usual service life cannot be completely ruled out in the current state of the art, even if they are operated as specified**. In customer applications requiring a very high level of operational safety and especially in customer applications in which the malfunction or failure of an electronic component could endanger human life or health (e.g. in accident prevention or life-saving systems), it must therefore be ensured by means of suitable design of the customer application or other action taken by the customer (e.g. installation of protective circuitry or redundancy) that no injury or damage is sustained by third parties in the event of malfunction or failure of an electronic component.
3. **The warnings, cautions and product-specific notes must be observed.**
4. In order to satisfy certain technical requirements, **some of the products described in this publication may contain substances subject to restrictions in certain jurisdictions (e.g. because they are classed as hazardous)**. Useful information on this will be found in our Material Data Sheets on the Internet (www.epcos.com/material). Should you have any more detailed questions, please contact our sales offices.
5. We constantly strive to improve our products. Consequently, **the products described in this publication may change from time to time**. The same is true of the corresponding product specifications. Please check therefore to what extent product descriptions and specifications contained in this publication are still applicable before or when you place an order.

We also **reserve the right to discontinue production and delivery of products**. Consequently, we cannot guarantee that all products named in this publication will always be available.

The aforementioned does not apply in the case of individual agreements deviating from the foregoing for customer-specific products.

6. Unless otherwise agreed in individual contracts, **all orders are subject to the current version of the "General Terms of Delivery for Products and Services in the Electrical Industry" published by the German Electrical and Electronics Industry Association (ZVEI)**.
7. The trade names EPCOS, BAOKE, Alu-X, CeraDiode, CSMP, CSSP, CTVS, DSSP, MiniBlue, MKK, MLSC, MotorCap, PCC, PhaseCap, PhaseCube, PhaseMod, SIFERRIT, SIFI, SIKOREL, SilverCap, SIMDAD, SIMID, SineFormer, SIOV, SIP5D, SIP5K, ThermoFuse, WindCap are **trademarks registered or pending** in Europe and in other countries. Further information will be found on the Internet at www.epcos.com/trademarks.

X-ON Electronics

Largest Supplier of Electrical and Electronic Components

Click to view similar products for [Fixed Inductors](#) category:

Click to view products by [EPCOS](#) manufacturer:

Other Similar products are found below :

[MLZ1608M6R8WTD25](#) [MLZ1608N6R8LT000](#) [MLZ1608N3R3LTD25](#) [MLZ1608N3R3LT000](#) [MLZ1608N150LT000](#)

[MLZ1608M150WTD25](#) [MLZ1608M3R3WTD25](#) [MLZ1608M3R3WT000](#) [MLZ1608M150WT000](#) [MLZ1608A1R5WT000](#)

[MLZ1608N1R5LT000](#) [B82432C1333K000](#) [PCMB053T-1R0MS](#) [PCMB053T-1R5MS](#) [PCMB104T-1R5MS](#) [CR32NP-100KC](#) [CR32NP-](#)

[151KC](#) [CR32NP-180KC](#) [CR32NP-181KC](#) [CR32NP-1R5MC](#) [CR32NP-390KC](#) [CR32NP-3R9MC](#) [CR32NP-680KC](#) [CR32NP-820KC](#)

[CR32NP-8R2MC](#) [CR43NP-390KC](#) [CR43NP-560KC](#) [CR43NP-680KC](#) [CR54NP-181KC](#) [CR54NP-470LC](#) [CR54NP-820KC](#) [CR54NP-8R5MC](#)

[MGDQ4-00004-P](#) [MGDU1-00016-P](#) [MHL1ECTTP18NJ](#) [MHL1JCTTD12NJ](#) [PE-51506NL](#) [PE-53601NL](#) [PE-53630NL](#) [PE-53824SNLT](#) [PE-](#)

[62892NL](#) [PE-92100NL](#) [PG0434.801NLT](#) [PG0936.113NLT](#) [PM06-2N7](#) [PM06-39NJ](#) [HC2LP-R47-R](#) [HC2-R47-R](#) [HC3-2R2-R](#) [HC8-1R2-R](#)