

40 SERIES

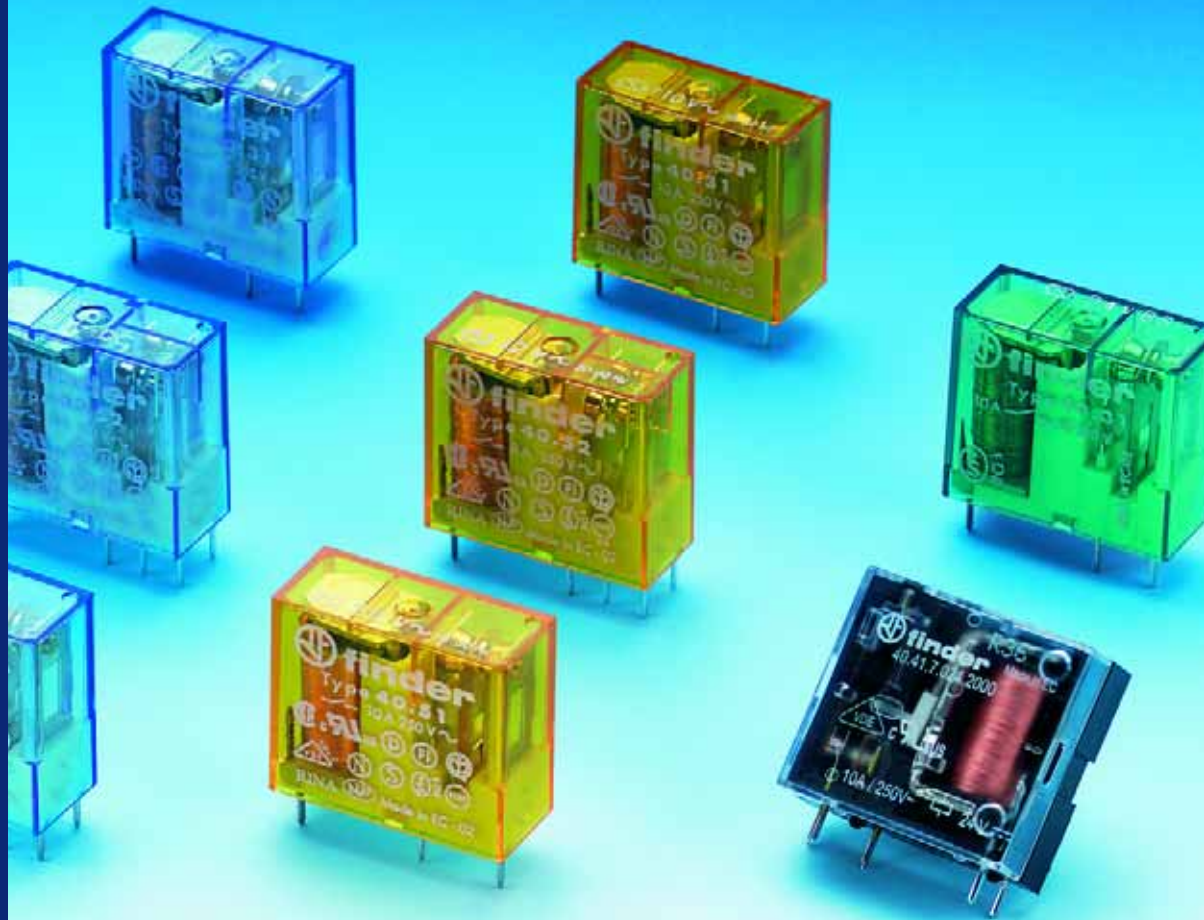

NEW

Miniature PCB relays

Features

- 1 & 2 Pole relay range**
 40.31 - 1 Pole 10 A (3.5 mm pin pitch)
 40.51 - 1 Pole 10 A (5 mm pin pitch)
 40.52 - 2 Pole 8 A (5 mm pin pitch)

- PCB mount**
 - direct or via PCB socket

- 35 mm rail mount**
 - via screw and screwless sockets

- DC coils (standard or sensitive) & AC coils
- Cadmium Free contact material
- 8 mm, 6 kV (1.2/50 μs) isolation, coil-contacts
- UL Listed (certain relay/socket combinations)
- Flux proof: RT II standard, (RT III option)
- 95 series sockets, coil EMC suppression and timer accessories

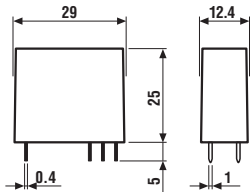

40.31



- 3.5 mm contact pin pitch
- 1 Pole 10 A
- PCB or 95 series sockets

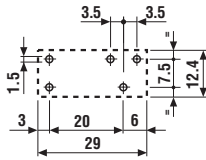
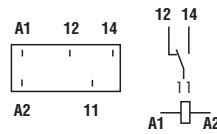

Copper side view

40.51



- 5 mm contact pin pitch
- 1 Pole 10 A
- PCB or 95 series sockets

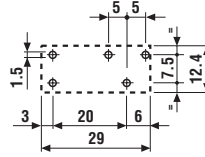
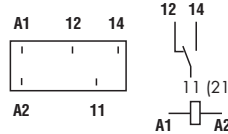

Copper side view

40.52



- 5 mm contact pin pitch
- 2 Pole 8 A
- PCB or 95 series sockets

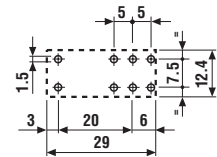
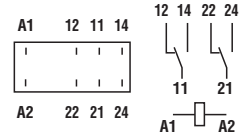

Copper side view

Contact specification				
Contact configuration		1 CO (SPDT)	1 CO (SPDT)	2 CO (DPDT)
Rated current/Maximum peak current	A	10/20	10/20	8/15
Rated voltage/Maximum switching voltage	V AC	250/400	250/400	250/250
Rated load AC1	VA	2,500	2,500	2,000
Rated load AC15 (230 V AC)	VA	500	500	400
Single phase motor rating (230 V AC)	kW	0.37	0.37	0.3
Breaking capacity DC1: 30/110/220 V	A	10/0.3/0.12	10/0.3/0.12	8/0.3/0.12
Minimum switching load	mW (V/mA)	300 (5/5)	300 (5/5)	300 (5/5)
Standard contact material		AgNi	AgNi	AgNi
Coil specification				
Nominal voltage (U _N)	V AC (50/60 Hz)	6 - 12 - 24 - 48 - 60 - 110 - 120 - 230 - 240		
	V DC	5 - 6 - 7 - 9 - 12 - 14 - 18 - 21 - 24 - 28 - 36 - 48 - 60 - 90 - 110 - 125		
Rated power AC/DC/sens. DC	VA (50 Hz)/W/W	1.2/0.65/0.5	1.2/0.65/0.5	1.2/0.65/0.5
Operating range	AC	(0.8...1.1)U _N	(0.8...1.1)U _N	(0.8...1.1)U _N
	DC/sens. DC	(0.73...1.5)U _N /(0.73...1.75)U _N	(0.73...1.5)U _N /(0.73...1.75)U _N	(0.73...1.5)U _N /(0.73...1.75)U _N
Holding voltage	AC/DC	0.8 U _N / 0.4 U _N	0.8 U _N / 0.4 U _N	0.8 U _N / 0.4 U _N
Must drop-out voltage	AC/DC	0.2 U _N / 0.1 U _N	0.2 U _N / 0.1 U _N	0.2 U _N / 0.1 U _N
Technical data				
Mechanical life AC/DC	cycles	10 · 10 ⁶ /20 · 10 ⁶	10 · 10 ⁶ /20 · 10 ⁶	10 · 10 ⁶ /20 · 10 ⁶
Electrical life at rated load AC1	cycles	200 · 10 ³	200 · 10 ³	100 · 10 ³
Operate/release time	ms	7/3 - (12/4 sensitive)	7/3 - (12/4 sensitive)	7/3 - (12/4 sensitive)
Insulation between coil and contacts (1.2/50 μs)	kV	6 (8 mm)	6 (8 mm)	6 (8 mm)
Dielectric strength between open contacts	V AC	1,000	1,000	1,000
Ambient temperature range	°C	-40...+85	-40...+85	-40...+85
Environmental protection		RT II	RT II	RT II
Approvals (according to type)				

Features

40.61 - 1 Pole 16 A (5 mm pin pitch)
40.xx.6 - Bistable versions of the 40.31, 40.51, 40.52 & 40.61 relays

PCB mount

- direct or via PCB socket

35 mm rail mount

- via screw and screwless sockets

- DC coils & AC coils
- Cadmium Free option available
- 8 mm, 6 kV (1.2/50 μ s) isolation, coil-contacts
- UL Listed (certain 40.61 relay/socket combinations)
- Flux proof: RT II standard, (RT III option)
- 95 series sockets, coil suppression and timer accessories

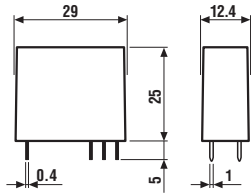

* With the AgSnO₂ material the maximum peak current is 120 A - 5 ms on normally open contact.

40.61



- 5 mm contact pin pitch
- 1 Pole 16 A
- PCB or 95 series sockets

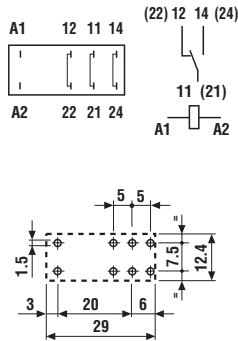

Copper side view

40.xx.6



- Bistable (single coil) versions of 40.31/51/52/61
- PCB or 95 series sockets

Bistable version (1 coil) types:

- 40.31.6...
- 40.51.6...
- 40.52.6...
- 40.61.6...

For wiring diagrams see page 8

Contact specification

Contact configuration	1 CO (SPDT)	
Rated current/Maximum peak current	A	16/30*
Rated voltage/Maximum switching voltage V AC		250/400
Rated load AC1	VA	4,000
Rated load AC15 (230 V AC)	VA	750
Single phase motor rating (230 V AC)	kW	0.55
Breaking capacity DC1: 30/110/220 V	A	16/0.3/0.12
Minimum switching load	mW (V/mA)	500 (10/5)
Standard contact material		AgCdO

Coil specification

Nominal voltage (U _N)	V AC (50/60 Hz)	6 - 12 - 24 - 48 - 60 - 110 - 120 - 230 - 240	5 - 6 - 12 - 24 - 48 - 110
	V DC	** See below	5 - 6 - 12 - 24 - 48 - 110
Rated power AC/DC/sens. DC	VA (50 Hz)/W/W	1.2/0.65/0.5	1.0/1.0/—
Operating range	AC	(0.8...1.1)U _N	(0.8...1.1)U _N
	DC/sens. DC	(0.73...1.5)U _N /(0.8...1.5)U _N	(0.8...1.1)U _N /—
Holding voltage	AC/DC	0.8 U _N / 0.4 U _N	—
Must drop-out voltage	AC/DC	0.2 U _N / 0.1 U _N	—

** Nominal voltage (U_N):
 5 - 6 - 7 - 9 - 12 - 14 - 18 - 21 -
 24 - 28 - 36 - 48 - 60 - 90 -
 110 - 125 V DC

Technical data

Mechanical life AC/DC	cycles	10 · 10 ⁶ /20 · 10 ⁶	See relays
Electrical life at rated load AC1	cycles	100 · 10 ³	40.31
Operate/release time	ms	7/3 - (12/4 sensitive)	40.51
Insulation between coil and contacts (1.2/50 μ s)	kV	6 (8 mm)	40.52
Dielectric strength between open contacts	V AC	1,000	40.61
Ambient temperature range	°C	-40...+85	Min. impulse duration
Environmental protection		RT II	≥ 20 ms

Approvals (according to type)



Features

1 Pole relay range

- 40.11 - 1 Pole 10 A (Flat pack)
- 40.11-2016 - 1 Pole 16 A (Flat pack)
- 40.41 - 1 Pole 10 A (Vertical)

PCB mount

- direct or via PCB socket (40.41 version)

- DC coils
- Cadmium Free option available
- 8 mm, 6 kV (1.2/50 μ s) isolation, coil-contacts
- 40.41 - NO version available

40.11



- 1 Pole 10 A
- Flat pack
- PCB mount

40.11-2016



- 1 Pole 16 A
- Flat pack
- PCB mount

40.41



- 1 Pole 10 A
- Vertical
- PCB or 95 series socket

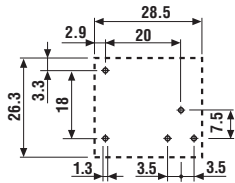
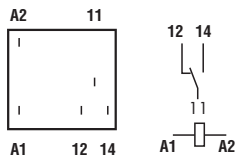
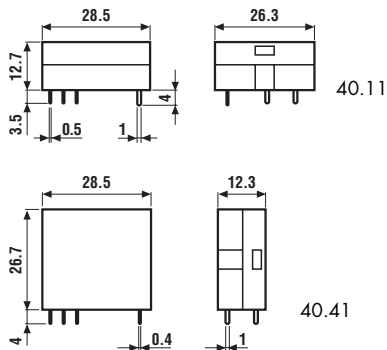

Copper side view

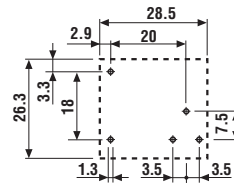
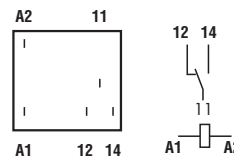

Copper side view

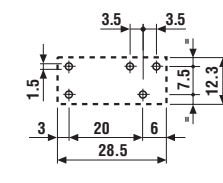
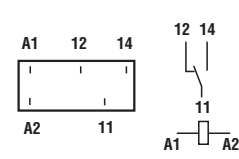

Copper side view

Contact specification				
Contact configuration		1 CO (SPDT)	1 CO (SPDT)	1 CO (SPDT)
Rated current/Maximum peak current	A	10/20	16/30	10/20
Rated voltage/Maximum switching voltage	V AC	250/400	250/400	250/400
Rated load AC1	VA	2,500	4,000	2,500
Rated load AC15 (230 V AC)	VA	500	750	500
Single phase motor rating (230 V AC)	kW	0.37	0.55	0.37
Breaking capacity DC1: 30/110/220 V	A	10/0.3/0.12	16/0.3/0.12	10/0.3/0.12
Minimum switching load	mW (V/mA)	300 (5/5)	500 (10/5)	300 (5/5)
Standard contact material		AgCdO	AgCdO	AgCdO
Coil specification				
Nominal voltage (U_N)	V AC (50/60 Hz)	—	—	—
	V DC	6 - 12 - 24 - 48 - 60	6 - 12 - 24 - 48	6 - 12 - 24 - 48 - 60
Rated power AC/DC/sens. DC	VA (50 Hz)/W/W	—/—/0.5	—/—/0.5	—/—/0.5
Operating range	AC	—	—	—
	DC/sens. DC	—/(0.73...1.75) U_N	—/(0.73...1.5) U_N	—/(0.73...1.75) U_N
Holding voltage	AC/DC	—/0.4 U_N	—/0.4 U_N	—/0.4 U_N
Must drop-out voltage	AC/DC	—/0.1 U_N	—/0.1 U_N	—/0.1 U_N
Technical data				
Mechanical life AC/DC	cycles	—/20 · 10 ⁶	—/20 · 10 ⁶	—/20 · 10 ⁶
Electrical life at rated load AC1	cycles	200 · 10 ³	50 · 10 ³	200 · 10 ³
Operate/release time	ms	12/4	12/4	12/4
Insulation between coil and contacts (1.2/50 μ s)	kV	6 (8 mm)	6 (8 mm)	6 (8 mm)
Dielectric strength between open contacts	V AC	1,000	1,000	1,000
Ambient temperature range	°C	−40...+70	−40...+70	−40...+70
Environmental protection		RT I	RT I	RT I

Approvals (according to type)



Ordering information

Example: 40 series PCB relay, 2 CO (DPDT), 230 V AC coil.

4

0

.

5

2

.

8

.

2

3

0

.

0

.

0

.

0

.

0

Series

Type
 1 = PCB - 3.5 mm pinning, flat
 3 = PCB - 3.5 mm pinning
 4 = PCB - 3.5 mm pinning
 5 = PCB - 5 mm pinning
 6 = PCB - 5 mm pinning

No. of poles
 1 = 1 pole
 for: 40.11, 10 A/16 A
 40.31, 10 A
 40.41, 10 A
 40.51, 10 A
 40.61, 16 A
 2 = 2 pole
 for 40.52, 8 A

Coil version
 6 = AC/DC bistable
 7 = Sensitive DC
 8 = AC (50/60 Hz)
 9 = DC

Coil voltage
 see coil specifications

A: Contact material
 0 = Standard AgNi
 for 40.31/51/52,
 AgCdO for 40.61
 1 = AgNi
 2 = AgCdO (standard
 for 40.11/41)
 4 = AgSnO₂
 5 = AgNi + Au (5 μm)

B: Contact circuit
 0 = CO (nPDT)
 3 = NO (nPST)

D: Special versions
 0 = Standard
 1 = Wash tight (RT III)
 3 = High temperature (+ 125 °C)
 wash tight

C: Options
 0 = None
 16 = With rated current 16 A (for 40.11)

Selecting features and options: only combinations in the same row are possible.
 Preferred selections for best availability are shown in **bold**.

Type	coil version	A	B	C	D
40.11	sens. DC	2 - 4	0	0	0
40.11	sens. DC	2 - 4	0	16	/
40.41	sens. DC	1 - 2	0 - 3	0	0
40.31/51	AC-sens. DC	0 - 2 - 5	0 - 3	0	0 - 1
40.31/51	DC	0 - 2 - 5	0 - 3	0	0 - 1 - 3
40.52	AC-sens. DC	0 - 2 - 5	0 - 3	0	0 - 1
40.52	DC	0 - 2 - 5	0 - 3	0	0 - 1 - 3
40.61	AC-sens. DC	0 - 4	0 - 3	0	0 - 1
40.61	DC	0 - 4	0 - 3	0	0 - 1 - 3
40.31/51/ 52/61	bistable	0	0	0	0

Technical data

Insulation		1 Pole		2 Pole	
Insulation according to EN 61810-1 ed. 2	insulation rated voltage	V	250	400	250
	rated impulse withstand voltage	kV	4	4	4
	pollution degree		3	2	2
	overvoltage category		III	III	III
Insulation between coil and contacts (1.2/50 μs)		kV	6 (8 mm)		
Dielectric strength between open contacts		V AC	1,000		
Dielectric strength between adjacent contacts		V AC	2,000		
Conducted disturbance immunity					
Burst (5...50)ns, 5 kHz, on A1 - A2			EN 61000-4-4	level 4 (4 kV)	
Surge (1.2/50 μs) on A1 - A2 (differential mode)			EN 61000-4-5	level 3 (2 kV)	
Other data					
Bounce time: NO/NC		ms	2/5		
Vibration resistance (5...55)Hz, max. ± 1 mm: NO/NC		g/g	10/4 (1 changeover)	15/3 (2 changeover)	
Shock resistance		g	13		
Power lost to the environment	without contact current	W	0.6		
	with rated current	W	1.2 (40.11/31/41/51)	2 (40.61/52/40.11-2016)	
Recommended distance between relays mounted on PCB		mm	≥ 5		

Contact specification

F 40 - Electrical life (AC) v contact current
Types 40.31/51/61

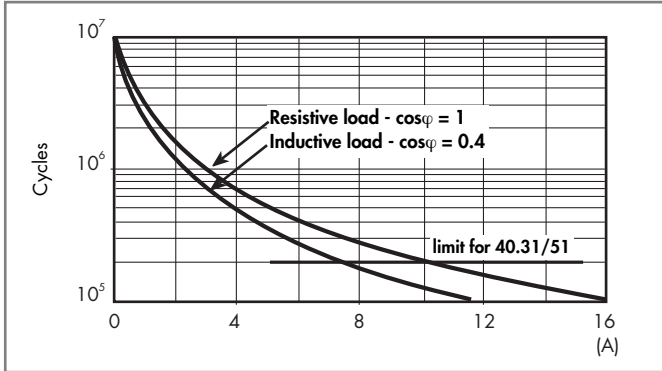

F 40 - Electrical life (AC) v contact current
Types 40.52

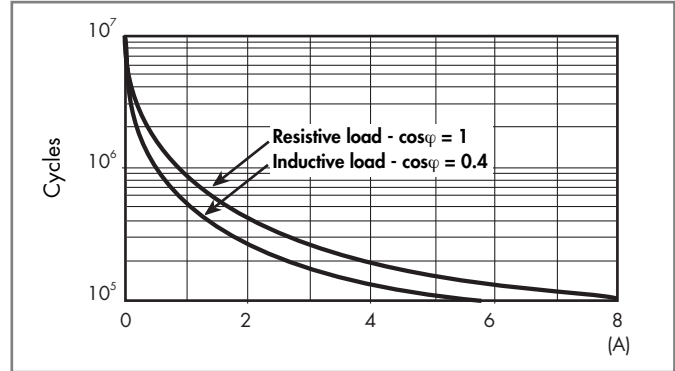

F 40 - Electrical life (AC) v contact current
Types 40.11/41

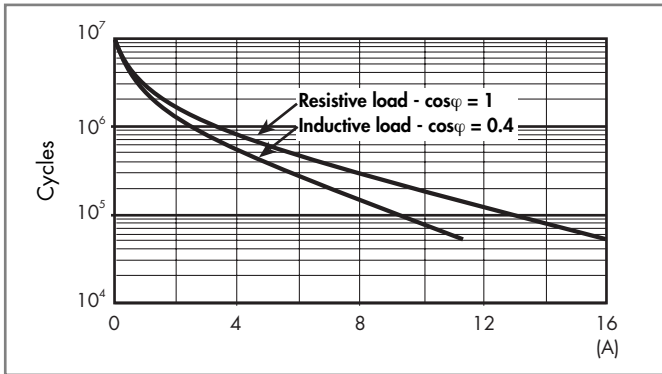

H 40 - Maximum DC1 breaking capacity

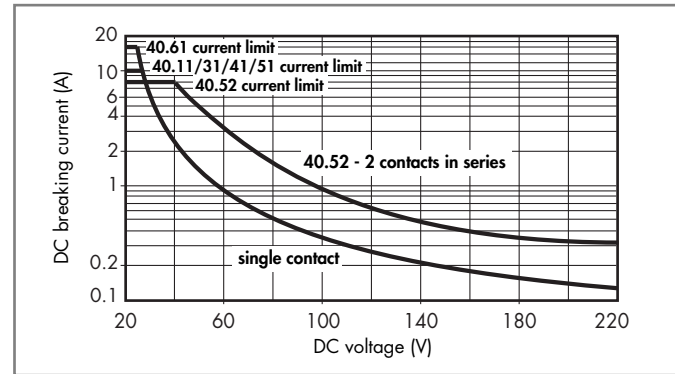

- When switching a resistive load (DC1) having voltage and current values under the curve, an electrical life of $\geq 100 \cdot 10^3$ can be expected.
- In the case of DC13 loads, the connection of a diode in parallel with the load will permit a similar electrical life as for a DC1 load.
Note: the release time for the load will be increased.

Coil specifications

DC coil data (0.65 W standard, types 40.31/51/52/61)

Nominal voltage U_N V	Coil code	Operating range		Resistance R Ω	Rated coil consumption I at U_N mA
		U_{min} V	U_{max} V		
5	9.005	3.65	7.5	38	130
6	9.006	4.4	9	55	109
7	9.007	5.1	10.5	75	94
9	9.009	6.6	13.5	125	72
12	9.012	8.8	18	220	55
14	9.014	10.2	21	300	47
18	9.018	13.1	27	500	36
21	9.021	15.3	31.5	700	30
24	9.024	17.5	36	900	27
28	9.028	20.5	42	1,200	23
36	9.036	26.3	54	2,000	18
48	9.048	35	72	3,500	14
60	9.060	43.8	90	5,500	11
90	9.090	65.7	135	12,500	7.2
110	9.110	80.3	165	18,000	6.2
125	9.125	91.2	187.5	23,500	5.3

DC coil data (0.5 W sensitive, types 40.31/51/52/61)

Nominal voltage U_N V	Coil code	Operating range		Resistance R Ω	Rated coil consumption I at U_N mA
		U_{min}^* V	U_{max}^{**} V		
5	7.005	3.7	8.8	50	100
6	7.006	4.4	10.5	75	80
7	7.007	5.1	12.2	100	70
9	7.009	6.6	15.8	160	56
12	7.012	8.8	21	300	40
14	7.014	10.2	24.5	400	35
18	7.018	13.2	31.5	650	27.7
21	7.021	15.4	36.9	900	23.4
24	7.024	17.5	42	1,200	20
28	7.028	20.5	49	1,600	17.5
36	7.036	26.3	63	2,600	13.8
48	7.048	35	84	4,800	10
60	7.060	43.8	105	7,200	8.4
90	7.090	65.7	157	16,200	5.6
110	7.110	80.3	192	23,500	4.7
125	7.125	91.2	218.7	32,000	3.9

* $U_{min} = 0.8 U_N$ for 40.61

** $U_{max} = 1.5 U_N$ for 40.61

DC coil data (0.5 W sensitive, types 40.11/41)

Nominal voltage U_N V	Coil code	Operating range		Resistance R Ω	Rated coil consumption I at U_N mA
		U_{min} V	U_{max}^* V		
6	7.006	4.4	10.5	75	80
12	7.012	8.8	21	300	40
24	7.024	17.5	42	1,200	20
48	7.048	35	84	4,600	10.4
60	7.060	43.8	105	7,200	8.3

* $U_{max} = 1.5 U_N$ for 40.11-2016

AC coil data, types 40.31/51/52/61

Nominal voltage U_N V	Coil code	Operating range		Resistance R Ω	Rated coil consumption I at U_N (50Hz) mA
		U_{min} V	U_{max} V		
6	8.006	4.8	6.6	21	168
12	8.012	9.6	13.2	80	90
24	8.024	19.2	26.4	320	45
48	8.048	38.4	52.8	1,350	21
60	8.060	48	66	2,100	16.8
110	8.110	88	121	6,900	9.4
120	8.120	96	132	9,000	8.4
230	8.230	184	253	28,000	5
240	8.240	192	264	31,500	4.1

AC/DC coil data (bistable, types 40.31/51/52/61)

Nominal voltage U_N V	Coil code	Operating range		Resistance R Ω	Rated coil consumption I at U_N mA	DC: Release resistance** R_{DC} Ω
		U_{min} V	U_{max} V			
5	6.005	4	5.5	23	215	37
6	6.006	4.8	6.6	33	165	62
12	6.012	9.6	13.2	130	83	220
24	6.024	19.2	26.4	520	40	910
48	6.048	38.4	52.8	2,100	21	3,600
110	6.110	88	121	11,000	10	16,500

** R_{DC} = Resistance in DC, $R_{AC} = 1.3 \times R_{DC}$ 1W

Coil specifications

R 40 - DC coil operating range v ambient temperature
Standard coil

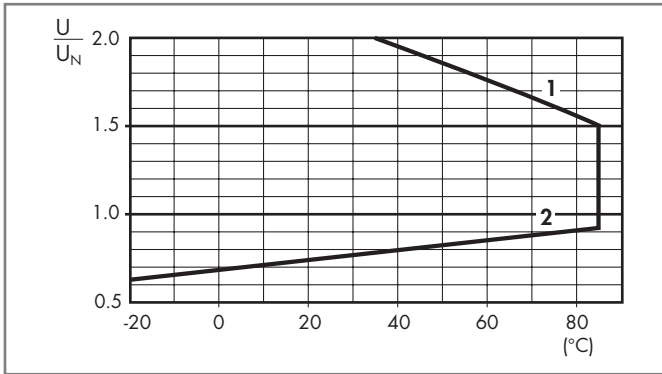

R 40 - DC coil operating range v ambient temperature
Sensitive coil, types 40.31/51/52/61

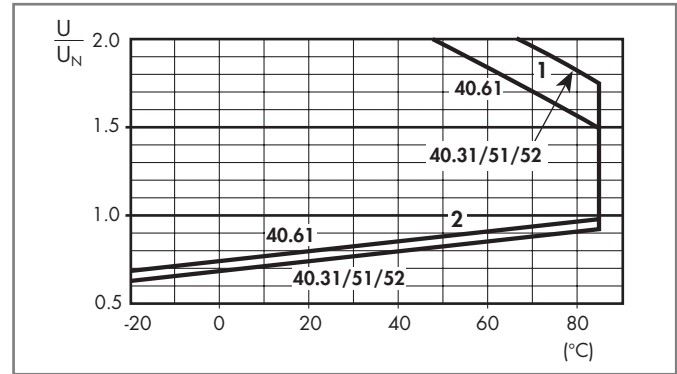

R 40 - DC coil operating range v ambient temperature
Sensitive coil, types 40.11/41

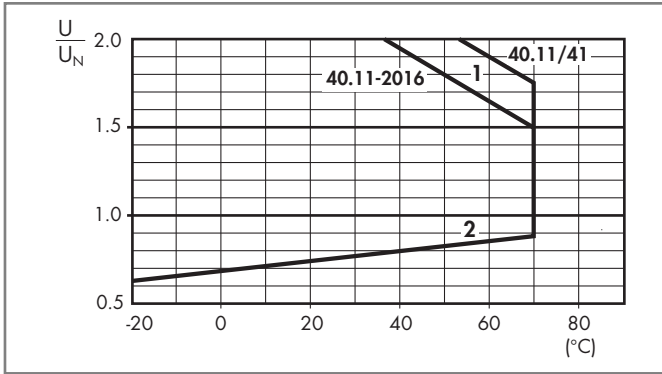

R 40 - AC coil operating range v ambient temperature

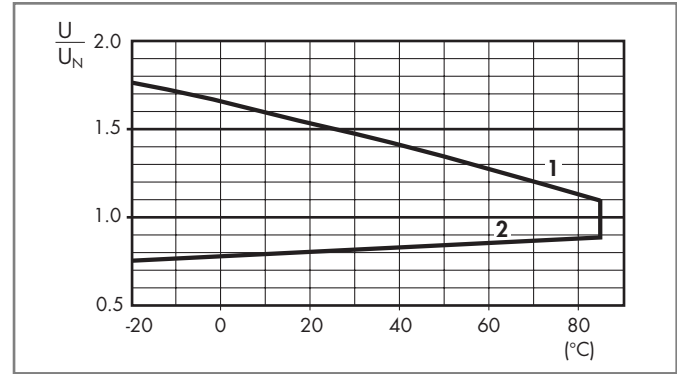

1 - Max. permitted coil voltage.
2 - Min. pick-up voltage with coil at ambient temperature.

1 - Max. permitted coil voltage.
2 - Min. pick-up voltage with coil at ambient temperature.

Wiring diagram for 40 series bistable coil version

AC Operation

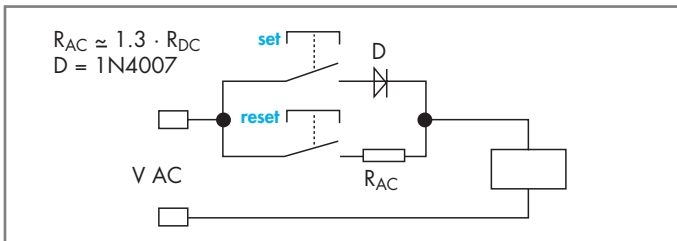

DC Operation

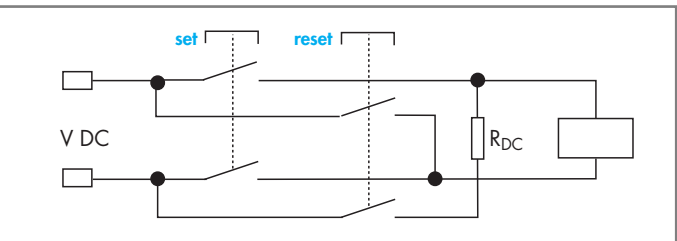

On momentary closure of the SET switch the relay is magnetised through the diode and the relay contacts transfer to the set position and remain in this position.

On momentary closure of the RESET switch the relay is demagnetised through limiting resistor (R_{AC}) and the contacts return to the reset position.

On momentary closure of the SET switch the relay is magnetised and the relay contacts transfer to the set position and remain in this position. On momentary closure of the RESET switch the relay is demagnetised through limiting resistor (R_{DC}) and the contacts return to the reset position.

Notes: The minimum SET or RESET impulse time is 20 ms. The maximum time can be continuous. In practice, always ensure that the SET and RESET contacts cannot be operated simultaneously.



95.05

See page 10

Module	Socket	Relay	Description	Mounting	Accessories
99.02	95.03	40.31	Screw terminal (Box clamp) socket	Panel or 35 mm rail (EN 50022) mount	<ul style="list-style-type: none"> - Coil indication and EMC suppression modules - Jumper link - Timer Modules - Plastic retaining and release clip
	95.05	40.51	Top terminals - Contacts		
		40.52	Bottom terminals - Coil		
		40.61			



95.85.3

See page 11

Module	Socket	Relay	Description	Mounting	Accessories
99.80	95.83.3	40.31	Screw terminal (Box clamp) socket	Panel or 35 mm rail (EN 50022) mount	<ul style="list-style-type: none"> - Coil indication and EMC suppression modules - Jumper link - Plastic retaining and release clip
	95.85.3	40.51	95.83.3 wiring:		
		40.52	Top terminals - Contacts		
		40.62	Bottom terminals - Coil		



95.95.3

See page 12

Module	Socket	Relay	Description	Mounting	Accessories
99.80	95.93.3	40.31	Screw terminal (Box clamp) socket	Panel or 35 mm rail (EN 50022) mount	<ul style="list-style-type: none"> - Coil indication and EMC suppression modules - Jumper link - Plastic retaining and release clip
	95.95.3	40.51	Top terminals - Contacts		
		40.52	Bottom terminals - Coil		
		40.61			



95.55

See page 13

Module	Socket	Relay	Description	Mounting	Accessories
99.02	95.55	40.51	Screwless terminal socket	Panel or 35 mm rail (EN 50022) mount	<ul style="list-style-type: none"> - Coil indication and EMC suppression modules - Timer Modules - Plastic retaining and release clip
		40.52	For fast cable connections		
		40.61	Top terminals - Contacts		
			Bottom terminals - Coil		

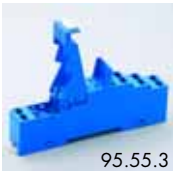

95.55.3

See page 14

Module	Socket	Relay	Description	Mounting	Accessories
99.80	95.55.3	40.51	Screwless terminal socket	Panel or 35 mm rail (EN 50022) mount	<ul style="list-style-type: none"> - Coil indication and EMC suppression modules - Plastic retaining and release clip
		40.52	For fast cable connections		
		40.61	Top terminals - Contacts		
			Bottom terminals - Coil		



95.13.2

See page 15

Module	Socket	Relay	Description	Mounting	Accessories
—	95.13.2	40.31	PCB socket	PCB mounting	<ul style="list-style-type: none"> - Metal retaining clip - Plastic retaining clip
		40.41			
—	95.15.2	40.51			
		40.52			
		40.61			

Top terminals

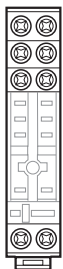

Bottom terminals



95.05

Approvals
(according to type):



Listed: certain relay/
socket combinations



095.01



060.72

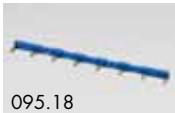

095.18



86.10



99.02

Approvals
(according to type):



* Modules in Black
housing are
available on request.

Screw terminal (Box clamp) socket panel or 35 mm rail mount	95.03 (blue)	95.03.0 (black)	95.05 (blue)	95.05.0 (black)
For relay type	40.31		40.51, 40.52, 40.61	
Accessories				
Metal retaining clip	095.71			
Plastic retaining and release clip (supplied with socket - packaging code SPA)	095.01	095.01.0	095.01	095.01.0
8-way jumper link	095.18	095.18.0	095.18	095.18.0
Identification tag	095.00.4			
Modules (see table below)	99.02			
Timer modules (see table below)	86.10, 86.20			
Sheet of marker tags for retaining and release clip 095.01 plastic, 72 tags, 6x12 mm	060.72			
Technical data				
Rated values	10 A - 250 V *			
Insulation	6 kV (1.2/50 μs) between coil and contacts			
Protection category	IP 20			
Ambient temperature	°C -40...+70			
Screw torque	Nm	0.5		
Wire strip length	mm	8		
Max. wire size for 95.03 and 95.05 sockets		solid wire	stranded wire	
	mm ²	1x6 / 2x2.5		1x4 / 2x2.5
	AWG	1x10 / 2x14		1x12 / 2x14

* For currents > 10 A, contact terminals must be connected in parallel (21 with 11, 24 with 14, 22 with 12).

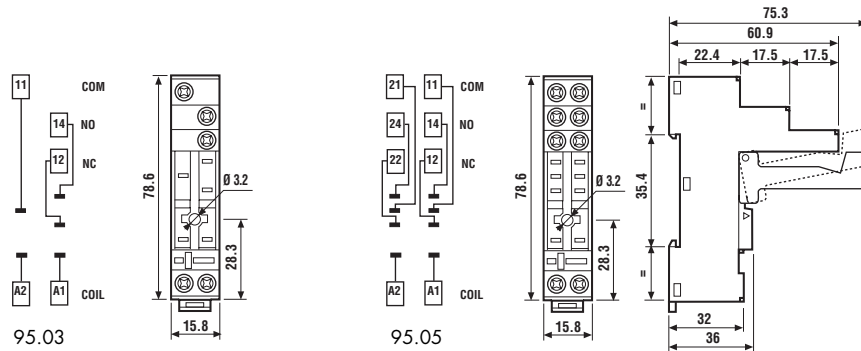

8-way jumper link for 95.03 and 95.05 sockets	095.18
Rated values	10 A - 250 V

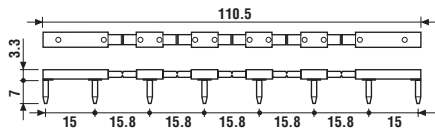

86 series timer modules	Blue
Mono-function: (12...24)V AC/DC; function AI; (1.5s...60min)	86.10.0.024.0000
Mono-function: (12...24)V AC/DC; function DI; (1.5s...60min)	86.20.0.024.0000

Approvals
(according to type):

99.02 coil indication and EMC suppression modules for 95.03 and 95.05 sockets	Blue*
Diode (+A1, standard polarity)	(6...220)V DC 99.02.3.000.00
LED	(6...24)V DC/AC 99.02.0.024.59
LED	(28...60)V DC/AC 99.02.0.060.59
LED	(110...240)V DC/AC 99.02.0.230.59
LED + Diode (+A1, standard polarity)	(6...24)V DC 99.02.9.024.99
LED + Diode (+A1, standard polarity)	(28...60)V DC 99.02.9.060.99
LED + Diode (+A1, standard polarity)	(110...240)V DC 99.02.9.220.99
LED + Varistor	(6...24)V DC/AC 99.02.0.024.98
LED + Varistor	(28...60)V DC/AC 99.02.0.060.98
LED + Varistor	(110...240)V DC/AC 99.02.0.230.98
RC circuit	(6...24)V DC/AC 99.02.0.024.09
RC circuit	(28...60)V DC/AC 99.02.0.060.09
RC circuit	(110...240)V DC/AC 99.02.0.230.09
Residual current by-pass (62 kΩ/1W)	(110...240)V AC 99.02.8.230.07



95.85.3

Approvals
(according to type):



095.91.3



060.72

Screw terminal (Box clamp) socket panel or 35 mm rail mount	95.83.3 (blue)	95.83.30 (black)	95.85.3 (blue)	95.85.30 (black)
For relay type	40.31		40.51, 40.52, 40.61	
Accessories				
Metal retaining clip	095.71			
Plastic retaining and release clip (supplied with socket - packaging code SPA)	095.91.3	095.91.30	095.91.3	095.91.30
8-way jumper link	095.08	095.08.0	095.08	095.08.0
Identification tag	095.80.3			
Modules (see table below)	99.80			
Sheet of marker tags for retaining and release clip 095.91.3 plastic, 72 tags, 6x12 mm	060.72			
Technical data				
Rated values	10 A - 250 V *			
Insulation	≥ 6 kV (1.2/50 μs) between coil and contacts (95.83.3 only)			
Protection category	IP 20			
Ambient temperature	°C	-40...+70		
⊕ Screw torque	Nm	0.5		
Wire strip length	mm	7		
Max. wire size for 95.83.3 and 95.85.3 sockets	solid wire			stranded wire
	m ²	1x6 / 2x2.5		1x4 / 2x2.5
	AWG	1x10 / 2x14		1x12 / 2x14

* For currents >10 A, contact terminals must be connected in parallel (21 with 11, 24 with 14, 22 with 12).

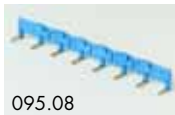
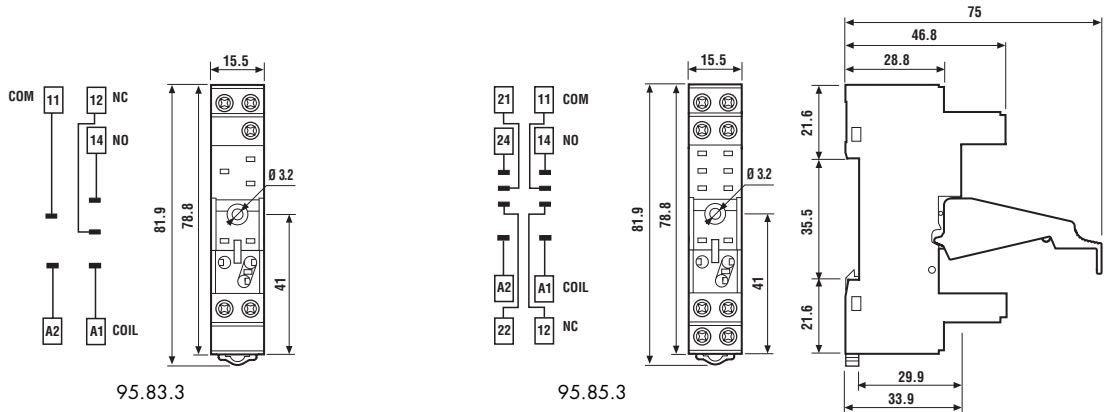

095.08

8-way jumper link for 95.83.3 and 95.85.3 sockets	095.08
Rated values	10 A - 250 V

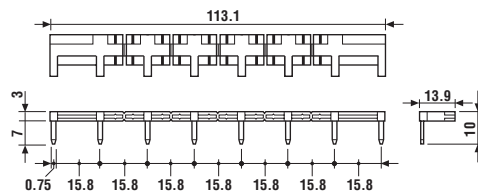

99.80

Approvals
(according to type):



* Modules in Black housing are available on request.

Green LED is standard.
Red LED available on request.

99.80 coil indication and EMC suppression modules for 95.83.3 and 95.85.3 sockets		Blue*
Diode (+A1, standard polarity)	(6...220)V DC	99.80.3.000.00
LED	(6...24)V DC/AC	99.80.0.024.59
LED	(28...60)V DC/AC	99.80.0.060.59
LED	(110...240)V DC/AC	99.80.0.230.59
LED + Diode (+A1, standard polarity)	(6...24)V DC	99.80.9.024.99
LED + Diode (+A1, standard polarity)	(28...60)V DC	99.80.9.060.99
LED + Diode (+A1, standard polarity)	(110...220)V DC	99.80.9.220.99
LED + Varistor	(6...24)V DC/AC	99.80.0.024.98
LED + Varistor	(28...60)V DC/AC	99.80.0.060.98
LED + Varistor	(110...240)V DC/AC	99.80.0.230.98
RC circuit	(6...24)V DC/AC	99.80.0.024.09
RC circuit	(28...60)V DC/AC	99.80.0.060.09
RC circuit	(110...240)V DC/AC	99.80.0.230.09
Residual current by-pass (62 kΩ/1W)	(110...240)V AC	99.80.8.230.07



95.95.3

Approvals
(according to type):



095.91.3



060.72

Screw (Box clamp) terminal socket panel or 35 mm rail mount	95.93.3 (blue)	95.93.30 (black)	95.95.3 (blue)	95.95.30 (black)
For relay type	40.31		40.51, 40.52, 40.61	
Accessories				
Metal retaining clip	095.71			
Plastic retaining and release clip	095.91.3	095.91.30	095.91.3	095.91.30
8-way jumper link	095.08	095.08.0	095.08	095.08.0
Identification tag	095.80.3			
Modules (see table below)	99.80			
Sheet of marker tags for retaining and release clip 095.91.3 plastic, 72 tags, 6x12 mm	060.72			
Technical data				
Rated values	10 A - 250 V			
Insulation	≥ 6 kV (1.2/50 μs) between coil and contacts			
Protection category	IP 20			
Ambient temperature	°C -40...+70			
Screw torque	Nm 0.5			
Wire strip length	mm 8			
Max. wire size for 95.93.3 and 95.95.3 sockets	solid wire		stranded wire	
	m ²	1x6 / 2x2.5	1x4 / 2x2.5	
	AWG	1x10 / 2x14	1x12 / 2x14	

* For currents > 10 A, contact terminals must be connected in parallel (21 with 11, 24 with 14, 22 with 12).

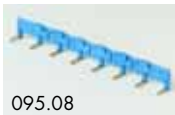
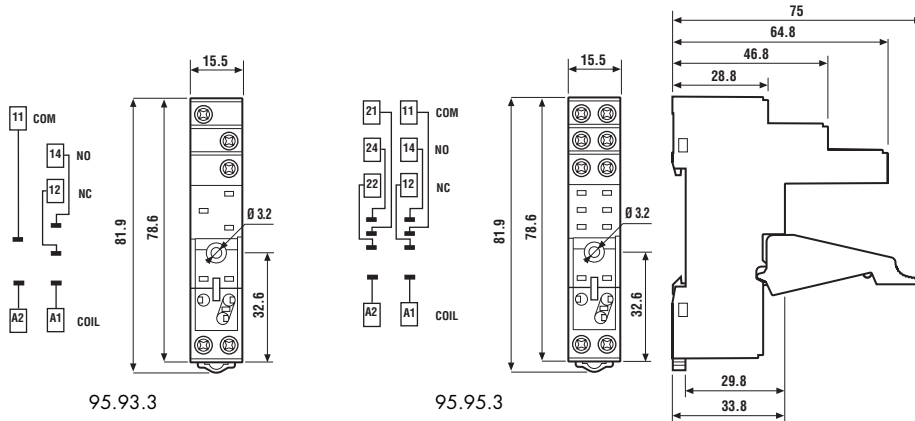

095.08

8-way jumper link for 95.93.3 and 95.95.3 sockets	095.08
Rated values	10 A - 250 V

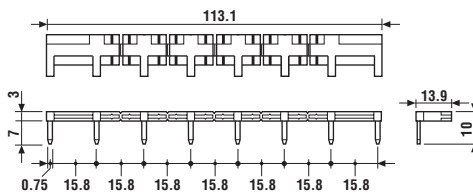

99.80

Approvals
(according to type):



* Modules in Black housing are available on request.

Green LED is standard. Red LED available on request.

99.80 coil indication and EMC suppression modules for 95.93.3 and 95.95.3 sockets		Blue*
Diode (+A1, standard polarity)	(6...220)V DC	99.80.3.000.00
LED	(6...24)V DC/AC	99.80.0.024.59
LED	(28...60)V DC/AC	99.80.0.060.59
LED	(110...240)V DC/AC	99.80.0.230.59
LED + Diode (+A1, standard polarity)	(6...24)V DC	99.80.9.024.99
LED + Diode (+A1, standard polarity)	(28...60)V DC	99.80.9.060.99
LED + Diode (+A1, standard polarity)	(110...220)V DC	99.80.9.220.99
LED + Varistor	(6...24)V DC/AC	99.80.0.024.98
LED + Varistor	(28...60)V DC/AC	99.80.0.060.98
LED + Varistor	(110...240)V DC/AC	99.80.0.230.98
RC circuit	(6...24)V DC/AC	99.80.0.024.09
RC circuit	(28...60)V DC/AC	99.80.0.060.09
RC circuit	(110...240)V DC/AC	99.80.0.230.09
Residual current by-pass (62 kΩ/1W)	(110...240)V AC	99.80.8.230.07



95.55

Approvals
(according to type):



095.91.3



060.72

Screwless terminal socket panel or 35 mm rail mount	95.55 (blue)	
For relay type	40.51, 40.52, 40.61	
Accessories		
Metal retaining clip	095.71	
Plastic retaining and release clip (supplied with socket - packaging code SPA)	095.91.3	
Modules (see table below)	99.02	
Timer modules (see table below)	86.10, 86.20	
Sheet of marker tags for retaining and release clip 095.91.3 plastic, 72 tags, 6x12 mm	060.72	
Technical data		
Rated values	10 A - 250 V *	
Insulation	6 kV (1.2/50 μs) between coil and contacts	
Protection category	IP 20	
Ambient temperature	°C	-25...+70
Wire strip length	mm	8
Max. wire size for 95.55 socket	solid wire	stranded wire
	mm ²	2x(0.2...1.5)
	AWG	2x(24...18)

* For currents >10 A, contact terminals must be connected in parallel (21 with 11, 24 with 14, 22 with 12).

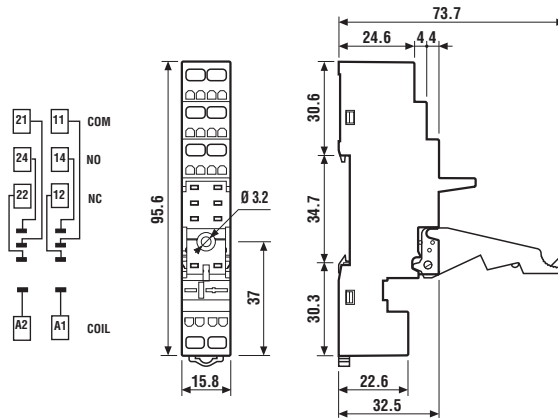

86.10

86 series timer modules	Blue
Mono-function: (12...24)V AC/DC; function AI; (1.5s...60min)	86.10.0.024.0000
Mono-function: (12...24)V AC/DC; function DI; (1.5s...60min)	86.20.0.024.0000

Approvals

(according to type):



99.02

Approvals
(according to type):



99.02 coil indication and EMC suppression modules for 95.55 socket		Blue*
Diode (+A1, standard polarity)	(6...220)V DC	99.02.3.000.00
LED	(6...24)V DC/AC	99.02.0.024.59
LED	(28...60)V DC/AC	99.02.0.060.59
LED	(110...240)V DC/AC	99.02.0.230.59
LED + Diode (+A1, standard polarity)	(6...24)V DC	99.02.9.024.99
LED + Diode (+A1, standard polarity)	(28...60)V DC	99.02.9.060.99
LED + Diode (+A1, standard polarity)	(110...220)V DC	99.02.9.220.99
LED + Varistor	(6...24)V DC/AC	99.02.0.024.98
LED + Varistor	(28...60)V DC/AC	99.02.0.060.98
LED + Varistor	(110...240)V DC/AC	99.02.0.230.98
RC circuit	(6...24)V DC/AC	99.02.0.024.09
RC circuit	(28...60)V DC/AC	99.02.0.060.09
RC circuit	(110...240)V DC/AC	99.02.0.230.09
Residual current by-pass (62 kΩ/1W)	(110...240)V AC	99.02.8.230.07

* Modules in Black housing are available on request.

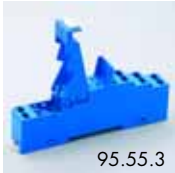

95.55.3

Approvals
(according to type):



095.91.3



060.72



99.80

Approvals
(according to type):



* Modules in Black housing are available on request.

Green LED is standard.
Red LED available on request.

Screwless terminal socket panel or 35 mm rail mount	95.55.3 (blue)	
For relay type	40.51, 40.52, 40.61	
Accessories		
Metal retaining clip	095.71	
Plastic retaining and release clip (supplied with socket - packaging code SPA)	095.91.3	
Modules (see table below)	99.80	
Sheet of marker tags for retaining and release clip 095.91.3 plastic, 72 tags, 6x12 mm	060.72	
Technical data		
Rated values	10 A - 250 V *	
Insulation	6 kV (1.2/50 μs) between coil and contacts	
Protection category	IP 20	
Ambient temperature	°C -25...+70	
Wire strip length	mm 8	
Max. wire size for 95.55.3 socket	solid wire	stranded wire
	mm ²	2x(0.2...1.5)
	AWG	2x(24...18)

* For currents >10 A, contact terminals must be connected in parallel (21 with 11, 24 with 14, 22 with 12).

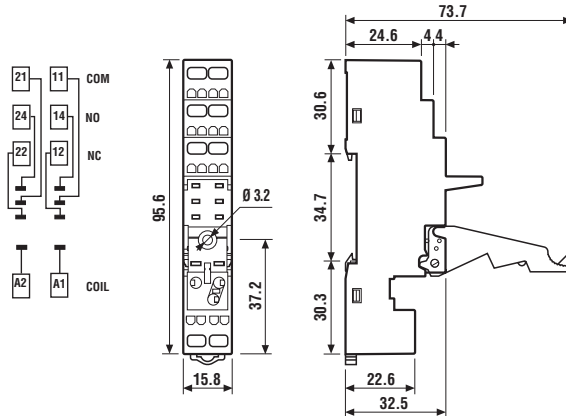

99.80 coil indication and EMC suppression modules for 95.55.3 socket		Blue*
Diode (+A1, standard polarity)	(6...220)V DC	99.80.3.000.00
LED	(6...24)V DC/AC	99.80.0.024.59
LED	(28...60)V DC/AC	99.80.0.060.59
LED	(110...240)V DC/AC	99.80.0.230.59
LED + Diode (+A1, standard polarity)	(6...24)V DC	99.80.9.024.99
LED + Diode (+A1, standard polarity)	(28...60)V DC	99.80.9.060.99
LED + Diode (+A1, standard polarity)	(110...220)V DC	99.80.9.220.99
LED + Varistor	(6...24)V DC/AC	99.80.0.024.98
LED + Varistor	(28...60)V DC/AC	99.80.0.060.98
LED + Varistor	(110...240)V DC/AC	99.80.0.230.98
RC circuit	(6...24)V DC/AC	99.80.0.024.09
RC circuit	(28...60)V DC/AC	99.80.0.060.09
RC circuit	(110...240)V DC/AC	99.80.0.230.09
Residual current by-pass (62 kΩ/1W)	(110...240)V AC	99.80.8.230.07



Approvals
(according to type):



PCB socket	95.13.2 (blue)	95.13.20 (black)	95.15.2 (blue)	95.15.20 (black)
For relay type	40.31, 40.41		40.51, 40.52, 40.61	
Accessories				
Metal retaining clip (supplied with socket - packaging code SMA)			095.51	
Plastic retaining clip			095.52	
Technical data				
Rated values	10 A - 250 V *			
Insulation	≥ 6 kV (1.2/50 μs) between coil and contacts			
Protection category	IP 20			
Ambient temperature	°C -40...+70			

* For currents >10 A, contact terminals must be connected in parallel (21 with 11, 24 with 14, 22 with 12).

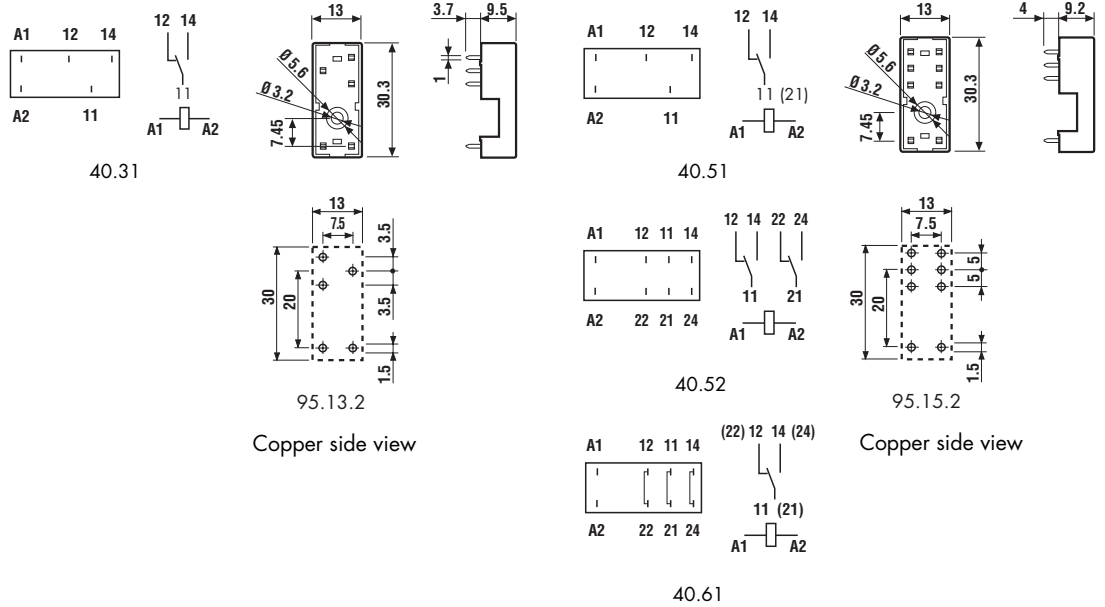

Packaging codes

How to code and identify retaining clip and packaging options for sockets.

Code options according to the last three letters:

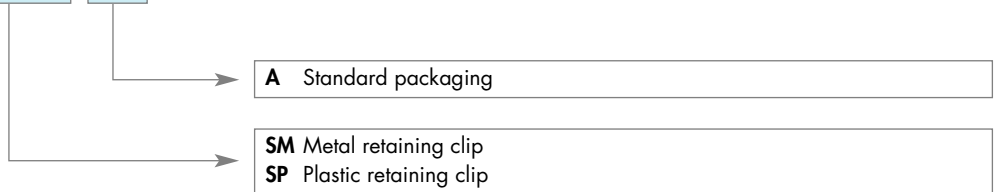

 **FINDER FRANCE Sarl**
Avenue d'Italie - BP 40
Zone Ind. du Pré de la Garde
F - 73302 ST. JEAN DE MAURIENNE Cédex
Tel. +33/479/83 27 27
Fax +33/479/59 80 04
Finder.fr@findernet.fr

 **FINDER GmbH**
Eisenstrasse 30
D - 65428 RÜSSELSHEIM
Tel. +49/6142/8770
Fax +49/6142/87777
finder.de@findernet.de

 **FINDER RELAYS, INC.**
4465 Commerce Drive, Suite: 103
Buford, GA 30518 - U.S.A.
Tel. +1/770/271-4431
Fax +1/770/271-7530
Finder.us@findernet.com

 **S.P.R.L. FINDER BELGIUM B.V.B.A.**
Bloemendael, 5
B - 1547 BEVER
Tel. +32/54/30 08 68
Fax +32/54/30 08 67
Finder.be@findernet.com

 **FINDER RELAIS NEDERLAND B.V.**
Dukdalfweg 51
NL - 1041 BC AMSTERDAM
Tel. +31/20/615 65 57
Fax +31/20/617 89 92
Finder.nl@findernet.com

 **FINDER COMPONENTES LTDA.**
Rua Olavo Bilac, 326
Bairro Santo Antonio
São Caetano do Sul - SÃO PAULO
CEP 09530-260 - BRASIL
Tel. +55/11/2147 1550
Fax +55/11/2147 1590
Finder.br@findernet.com

 **FINDER PLC**
Opal Way - Stone Business Park
STONE, STAFFORDSHIRE,
ST15 OSS - UK
Tel. +44/1785/818100
Fax +44/1785/815500
Finder.uk@findernet.com

 **FINDER RELAIS VERTRIEBS GmbH**
Aspangbahnstraße 2
A - 2361 LAXENBURG
Tel. +43/2236/86 41 36 - 0
Fax +43/2236/86 41 36 36
Finder.at@findernet.com

 **RELEVADORES FINDER, S.A. de C.V.**
Boulevard Hermanos Serdan No. 337
Local C, Col. Aquiles Serdan
C.P. 72140
Puebla, Pue. - MEXICO
Tel. +52/222/2973197
Fax +52/222/2973198
Finder.mx@findernet.com

 **FINDER AB**
Stationsvägen, 1
SE - 435 25 MÖLNLYCKE
Tel. +46/31/88 00 99
Fax +46/31/88 06 04
Finder.se@findernet.com

 **FINDER CZ, s.r.o.**
Hostivařská 6/92
CZ - 102 00 PRAHA 10
Tel. +420/2 8688 9504
Fax +420/2 8688 9505
Finder.cz@findernet.com

 **FINDER ECHIPAMENTE srl**
Str. Lunii, 6
400367 CLUJ-NAPOCA
jud. CLUJ - ROMANIA
Tel. +40 264 403 888
Fax +40 264 403 889
Finder.ro@findernet.com

 **FINDER ELECTRICA S.L.**
Pol. Ind. La Pobla L'Eliana, s/n. Parcela N° 4
E - 46185 La Pobla de Vallbona (VALENCIA)
Dirección Postal Aptdo 234
Tel. +34-96 272 52 95
Fax +34-96 275 02 50
Finder.es@findernet.com

 **FINDER - Hungary Kereskedelmi Kft.**
1046 BUDAPEST
Kiss Ernő u. 1-3
Tel. +06/1-399-15-25
Fax +06/1-399-15-27
Finder.hu@findernet.com

 **FINDER PORTUGAL, LDA**
R. Antero de Quental
Edificio Hermes N° 221 R/C Sala 17
P - 4455 - 586 - PERAFITA
Tel. +351/22 99 42 900 - 1
Fax +351/22 99 42 902
Finder.pt@findernet.com

 **FINDER (SCHWEIZ) AG**
Industriestrasse, 1a, Postfach 23
CH - 8157 DIELSDORF (ZH)
Tel. +41/44/885 30 10
Fax +41/44/885 30 20
Finder.ch@finder-relais.ch

X-ON Electronics

Largest Supplier of Electrical and Electronic Components

Click to view similar products for [finder manufacturer](#):

Other Similar products are found below :

[60.12.8.024.0040](#) [66.82.8.230.0000](#) [14.81.8.230.0000](#) [14.71.8.230.0000](#) [20.23.8.012.4000](#) [22.22.9.012.4000](#) [22.34.0.024.4340](#)
[22.34.0.024.4720](#) [22.64.0.230.4310](#) [20.21.8.024.4000](#) [20.22.8.024.4000](#) [20.28.8.024.4000](#) [22.22.8.024.4000](#) [22.32.0.230.4440](#)
[26.06.8.024.0000](#) [40.52.8.006.0000](#) [44.52.9.060.0000](#) [10.42.8.230.0000](#) [11.42.8.230.0000](#) [65.61.9.012.0300](#) [88.02.0.230.0002](#) [96.04SMA](#)
[55.12.8.024.0000](#) [55.33.8.230.0000](#) [56.34.9.024.0000T](#) [66.82.8.230.0300](#) [39.11.0.006.0060](#) [55.14.8.024 0000](#) [40.31.8.240.0000](#)
[66.22.8.230.1300](#) [72.11.8.024.0000](#) [71.51.8.230.1021](#) [4CP281100060SPA](#) [18.21.8.230.0300](#) [40.62.9.024.0000](#) [50.14.9.024.4310](#)
[7S.16.9.012.0420](#) [83.91.0.240.0000](#) [22.22.9.048.4000](#) [22.64.0.230.4710](#) [26.08.8.012.0000](#) [20.21.8.012.4000](#) [20.23.9.110.4000](#)
[20.26.8.230.4000](#) [22.34.0.230.4340](#) [22.34.0.230.4720](#) [22.44.0.230.4710](#) [10.61.8.230.0000](#) [55.14.9.012.0000](#) [22.32.0.012.4420](#)