

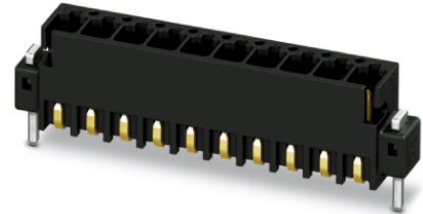

MCV 0,5/ 3-G-2,54 SMD R24

Order No.: 1821559

The illustration shows the 10-position version

<http://eshop.phoenixcontact.co.uk/phoenix/treeViewClick.do?UID=1821559>

Header, Nominal current: 6 A, Rated voltage (III/2): 160 V, Number of positions: 3, Pitch: 2.54 mm, Color: Black, Contact surface: Gold, Assembly: Taped SMD/THT/THR components

Commercial data	
EAN	 4 046356 789714
Note	Made-to-order
Pack	315
Customs tariff	85366990
Gross weight in pieces	2.22 g
Country of Origin	DE
Catalog page information	Page 177 (CAT-1-2013)

Product notes

WEEE/RoHS-compliant since:
30/07/2012



Please note that the data given here has been taken from the online catalog. For comprehensive information and data, please refer to the user documentation at <http://www.download.phoenixcontact.com>. The General Terms and Conditions of Use apply to Internet downloads.

Certificates

Certification

Certifications applied for:

Certification Ex:

Accessories

Item	Designation	Description
Marking		
0804853	SK 2,54/2,8:FORTL.ZAHLEN	Marker cards, Card, white, labeled, Horizontal: Consecutive numbers 1 - 10, 11 - 20, etc. up to 91 - 99, Mounting type: Adhesive, For terminal block width: 2.54 mm

Additional products

Item	Designation	Description
General		
1821106	FMC 0,5/ 3-ST-2,54	Plug component, Nominal current: 6 A, Rated voltage (III/2): 160 V, Number of positions: 3, Pitch: 2.54 mm, Connection method: Spring-cage conn., Color: Black, Contact surface: Gold

Drawings

Drilling plan/solder pad geometry

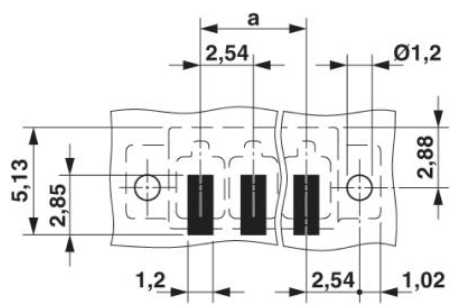

Dimensioned drawing

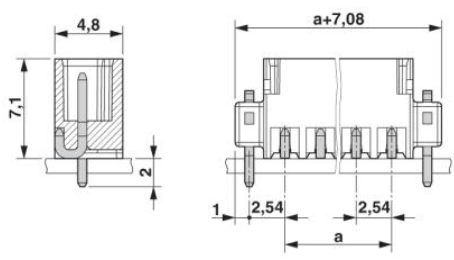

Address

PHOENIX CONTACT Ltd
Halesfield 13
Telford / Shropshire / TF7 4PG,England
Phone 01952 681 700
Fax 01952 681 799
<http://www.phoenixcontact.co.uk>



Phoenix Contact Ltd.
Technical modifications reserved;

X-ON Electronics

Largest Supplier of Electrical and Electronic Components

Click to view similar products for [FFC & FPC Connectors](#) category:

Click to view products by [Phoenix Contact](#) manufacturer:

Other Similar products are found below :

[HFW11R-1STE1H1LF](#) [FH29B-100S-0.2SHW\(99\)](#) [FA5S008HP1](#) [FH29B-120S-0.2SHW\(99\)](#) [FH29B-80S-0.2SHW\(99\)](#) [FHS-16](#) [FPH-2022G](#)
[52610-1075](#) [52610-1275](#) [52610-1934](#) [XF3M\(1\)-1415-1B-R100](#) [501864-3091-TR225](#) [0525594033](#) [086210010340800](#) [086222026001800](#)
[52271-2869-CUT-TAPE](#) [62674-201121DLF](#) [62684-36210E9ALF](#) [52610-1675](#) [52746-1671-TR250](#) [10051922-2810EHLF](#) [6-520415-9](#)
[BD021-09A-A1-0350-0200-0550-LD](#) [SFV6R-1STE9HLF](#) [XF3M-2915-1B-R100](#) [1658549-1](#) [62674-221121ALF](#) [46214008010800](#)
[046298003000883](#) [151660622](#) [842-816-2630-035](#) [AYF530665TA](#) [AYF351525](#) [046296011930846+](#) [AYF352325A](#) [046254020000800+](#)
[FH19C-13S-0.5SH\(99\)](#) [FH39J-51S-0.3SHW\(99\)](#) [AYF355125A](#) [AYF530365TA](#) [FH29B-44S-0.2SHW\(99\)](#) [SFW5R-2STAE9LF](#) [AYF351125A](#)
[AYF350725A](#) [62684-502100AHLF](#) [FH39-61S-0.3SHW\(99\)](#) [AYF414035A](#) [10064555-172520HLF](#) [AYF212335A](#) [504754-2500](#)