

# SNAP D-Series Racks

## Features

- Ideal for discrete control applications
- Control directly or through an Opto 22 PC adapter card
- Use panel or DIN-rail mounting
- Modules snap into place

## Description

SNAP D-series racks are designed for discrete control applications and can accommodate 4, 6, 8, or 12 SNAP 4-channel digital modules. These racks use an industry-standard 50-pin header connector, which allows these racks to be used in a variety of applications.

The logic side of the I/O circuitry can be controlled directly or by using an Opto 22 PCIe-AC5 (PCI Express bus), PCI-AC5 (PCI bus) or G4AC5 or AC5 (ISA bus) PC adapter card. In addition, the 4-module-position SNAP-D4M can be used with Opto 22's Classic brain boards. These boards use one of Opto 22's industry-standard protocols (*mistic*<sup>®</sup>, *Optomux*<sup>®</sup>, or *Pamux*<sup>®</sup>) to control the I/O and communicate either serially or in parallel.

Field devices are wired directly to the top-mounted removable connectors on the SNAP I/O modules. The module and rack design allows modules to simply "snap" on and off the mounting rack.

SNAP racks use a retention-rail locking system that holds modules securely to the rack. Normally, a hold-down screw is not required. However, for applications that require additional mounting security, SNAP racks have provisions for two 4-40 by 1/2-inch standard machine screws to hold each module in position.

All SNAP racks offer panel mounting and the option of DIN-rail mounting. SNAP racks use a single 5 VDC power source.



SNAP-D8M Rack

## Part Numbers

Part	Description
SNAP-D4M	4-module rack
SNAP-D6M	6-module rack
SNAP-D8M	8-module rack
SNAP-D12M	12-module rack
SNAP-CDBBDIN	Classic digital brain board DIN rail adapter
SNAP-FUSE1AB	1 amp fuse, 25-pack
SNAP-TEX-DRC10	SNAP PAC rack DIN-rail adapter clip, 10-pack
SNAP-TEX-REC10N	Narrow end cap for SNAP PAC racks DIN-rail assemblies, 10-pack

# SNAP D-Series Racks

## Specifications: SNAP-D4M (4 Module Position)

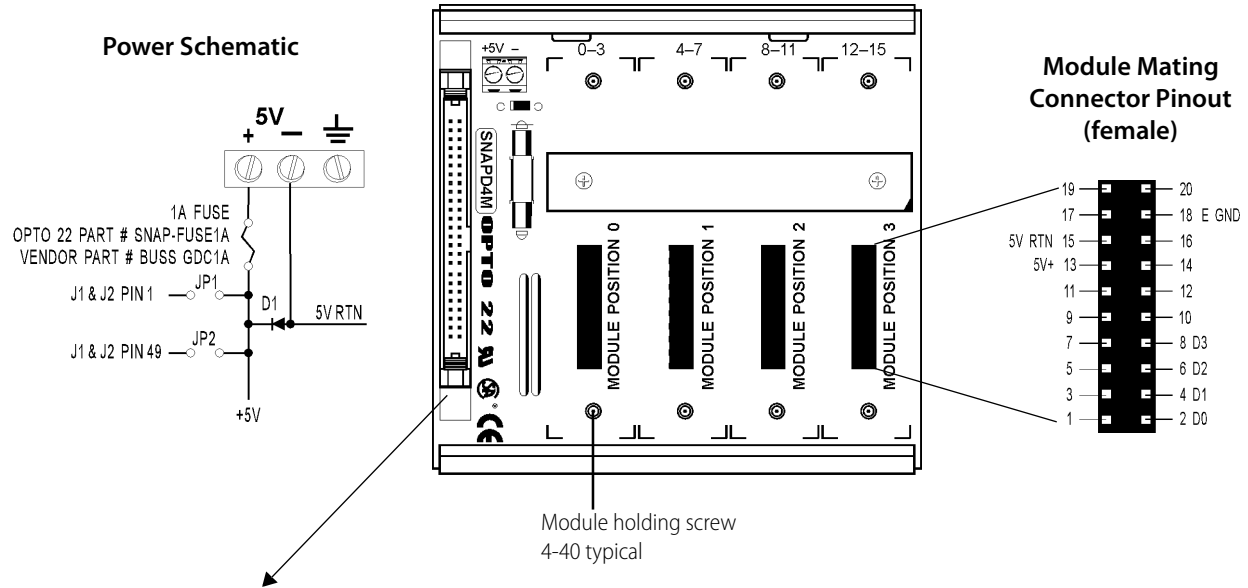

### Control Connector (50-pin male)

Module Position	Channel Position	J1 Control Connector
0	0	47
	1	45
	2	43
	3	41
1	4	39
	5	37
	6	35
	7	33
2	8	31
	9	29
	10	27
	11	25
3	12	23
	13	21
	14	19
	15	17

### Operating Requirements

Power Requirements	5 VDC ± 0.1 VDC @ 200 mA max. (700 mA with brain board)
Operating Temperature Range	0° to 70°C
Relative Humidity	95%, non-condensing

### Notes:

1. Even pins on control connectors are connected to 5V RTN.
2. Pin 1 of control connectors J1 and J2 is connected to +5V through jumper JP1.
3. Pin 49 of control connectors J1 and J2 is connected to +5V through jumper JP2.
4. For operation with PC adapter cards (PCIe-AC5, PCI-AC5, AC5, or G4AC5), remove jumpers JP1 and JP2.
5. Odd numbered pins 3 through 15 of control connectors are not used.

# SNAP D-Series Racks

## Specifications: SNAP-D6M (6 Module Position)

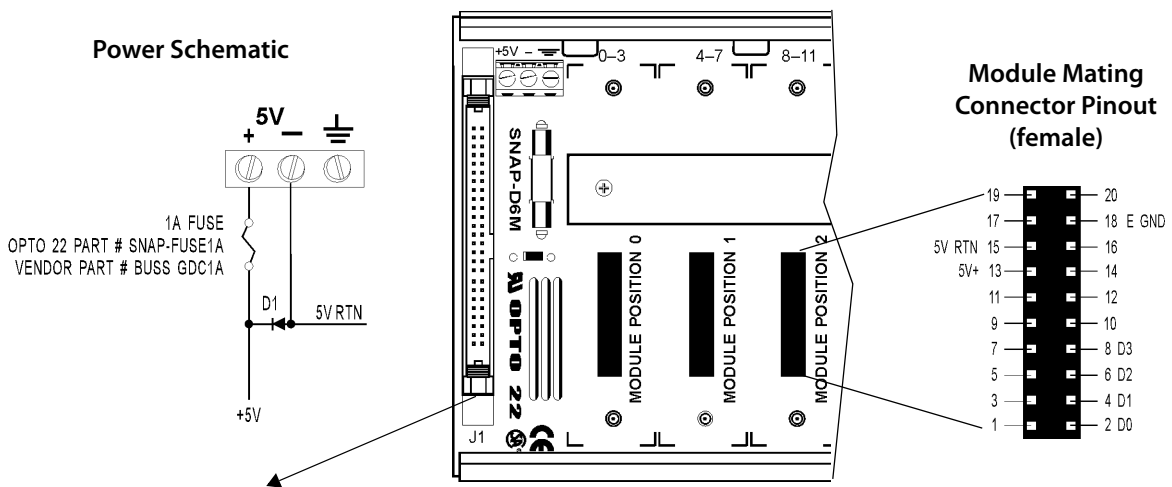

### Control Connector (50-pin male)

Module Position	Channel Position	J1 Control Connector
0	0	47
	1	45
	2	43
	3	41
1	4	39
	5	37
	6	35
	7	33
2	8	31
	9	29
	10	27
	11	25
3	12	23
	13	21
	14	19
	15	17
4	16	15
	17	13
	18	11
	19	9
5	20	7
	21	5
	22	3
	23	1

### Operating Requirements

Power Requirements	5 VDC $\pm$ 0.1 VDC @ 300 mA max.
Operating Temperature Range	0° to 70°C
Relative Humidity	95%, non-condensing

### Notes:

1. Even pins on control connectors are connected to 5V RTN.
2. SNAP-D6M and SNAP-D12M are designed to interface with PC adapter cards (PCIe-AC5, PCI-AC5, AC5, or G4AC5). They are not compatible with brain boards, because there is no power to the control connector.
3. Pin 49 - "no" connection.

# SNAP D-Series Racks

## Specifications: SNAP-D8M (8 Module Position)

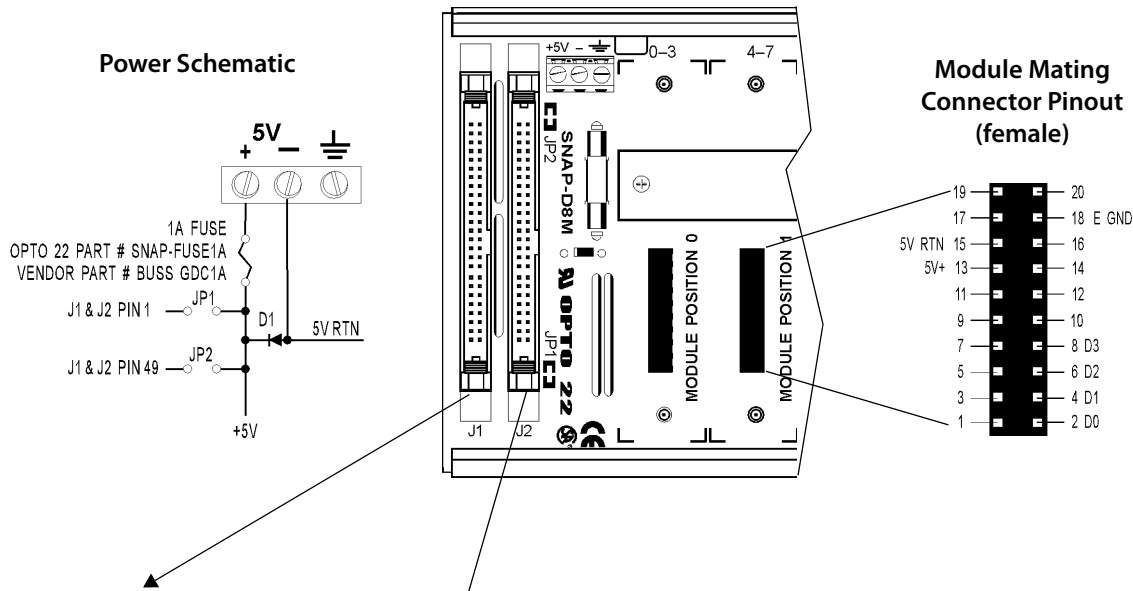

### Control Connectors (50-pin male)

Module Position	Channel Position	J1 Control Connector
0	0	47
	1	45
	2	43
	3	41
1	4	39
	5	37
	6	35
	7	33
2	8	31
	9	29
	10	27
	11	25
3	12	23
	13	21
	14	19
	15	17

Module Position	Channel Position	J2 Control Connector
4	16	47
	17	45
	18	43
	19	41
5	20	39
	21	37
	22	35
	23	33
6	24	31
	25	29
	26	27
	27	25
7	28	23
	29	21
	30	19
	31	17

### Operating Requirements

Power Requirements	5 VDC ± 0.1 VDC @ 400 mA max.
Operating Temperature Range	0° to 70°C
Relative Humidity	95%, non-condensing

### Notes:

1. Even pins on control connectors are connected to 5V RTN.
2. Pin 1 of control connectors J1 and J2 is connected to +5V through jumper JP1.
3. Pin 49 of control connectors J1 and J2 is connected to +5V through jumper JP2.
4. For operation with PC adapter cards (PCIe-AC5, PCI-AC5, AC5, or G4AC5), remove jumpers JP1 and JP2.
5. Odd numbered pins 3 through 15 of control connectors are not used.

# SNAP D-Series Racks

## Specifications: SNAP-D12M (12 Module Position)

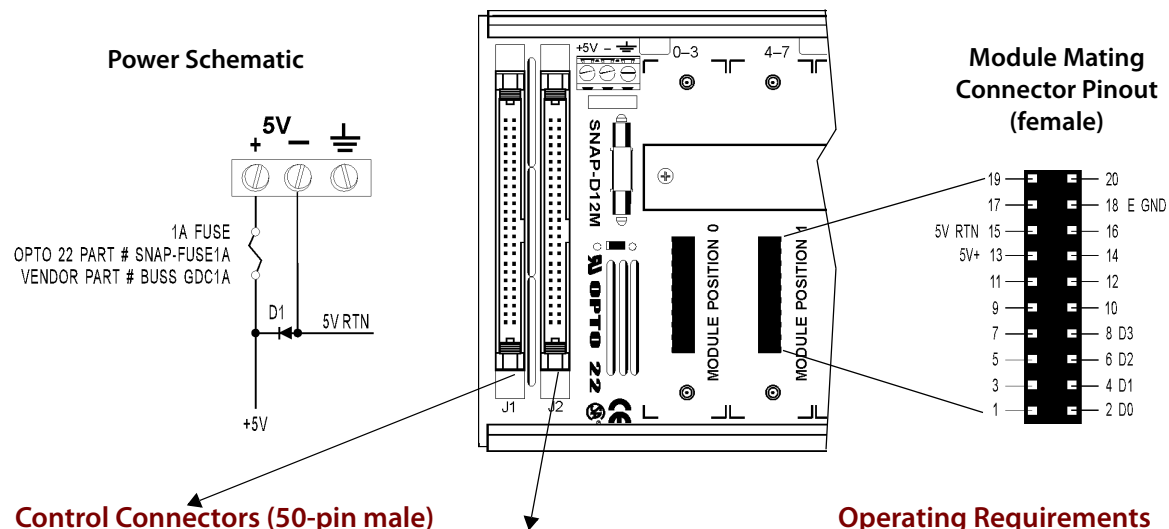

### Control Connectors (50-pin male)

Module Position	Channel Position	J1 Control Connector
0	0	47
	1	45
	2	43
	3	41
1	4	39
	5	37
	6	35
	7	33
2	8	31
	9	29
	10	27
	11	25
3	12	23
	13	21
	14	19
	15	17
4	16	15
	17	13
	18	11
	19	9
5	20	7
	21	5
	22	3
	23	1

Module Position	Channel Position	J2 Control Connector
6	0	47
	1	45
	2	43
	3	41
7	4	39
	5	37
	6	35
	7	33
8	8	31
	9	29
	10	27
	11	25
9	12	23
	13	21
	14	19
	15	17
10	16	15
	17	13
	18	11
	19	9
11	20	7
	21	5
	22	3
	23	1

### Operating Requirements

Power Requirements	5 VDC $\pm$ 0.1 VDC @ 1200mA max.
Operating Temperature Range	0° to 70°C
Relative Humidity	95%, non-condensing

### Notes

1. Even pins on control connectors are connected to 5V RTN.
2. SNAP-D6M and SNAP-D12M are designed to interface with PC adapter cards (PCIe-AC5, PCI-AC5, AC5, or G4AC5). They are not compatible with brain boards, because there is no power to the control connector.

# SNAP D-Series Racks

## Dimensional Drawing

Front View (when Mounted)—All Models

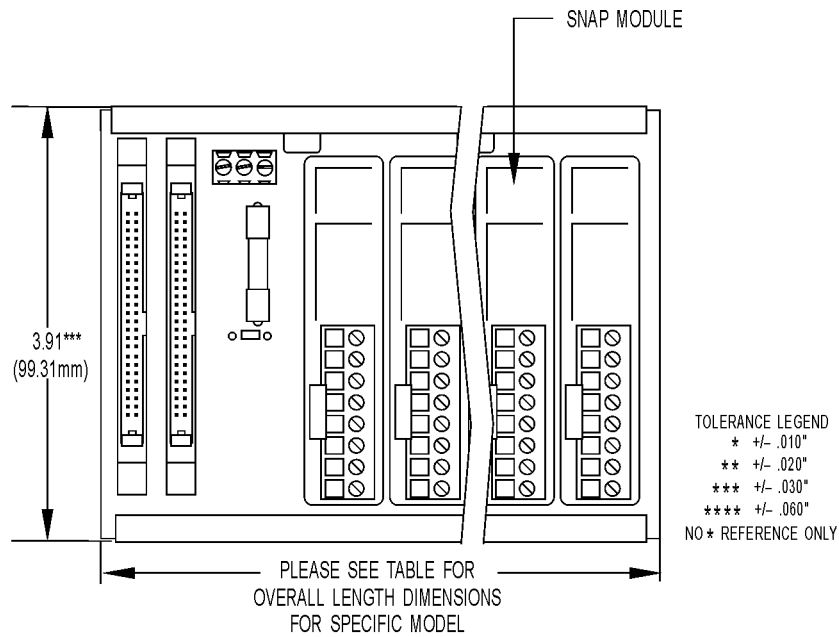

### Overall Length Dimension (All Models)

Part Numbers	Description	Length (inches)	Length (mm)
SNAP-D4M	4-module rack	4.19	106.43
SNAP-D6M	6-module rack	5.74	145.8
SNAP-D8M	8-module rack	7.74	196.6
SNAP-D12M	12-module rack	10.74	272.8

# SNAP D-Series Racks

## Dimensional Drawing

Right Side View (with Customer-supplied DIN-Rail Option)—All Models

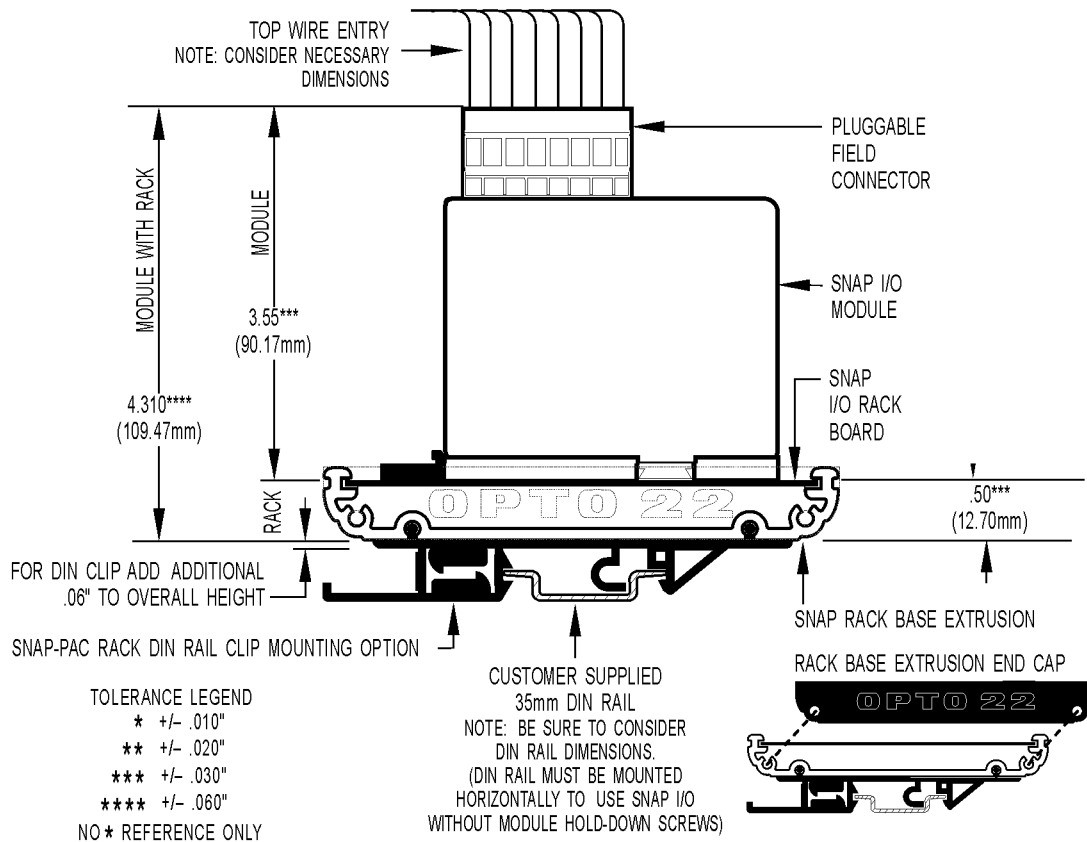

## Dimensional Drawing

Typical Plain View of SNAP Mounting Extrusion—All Models

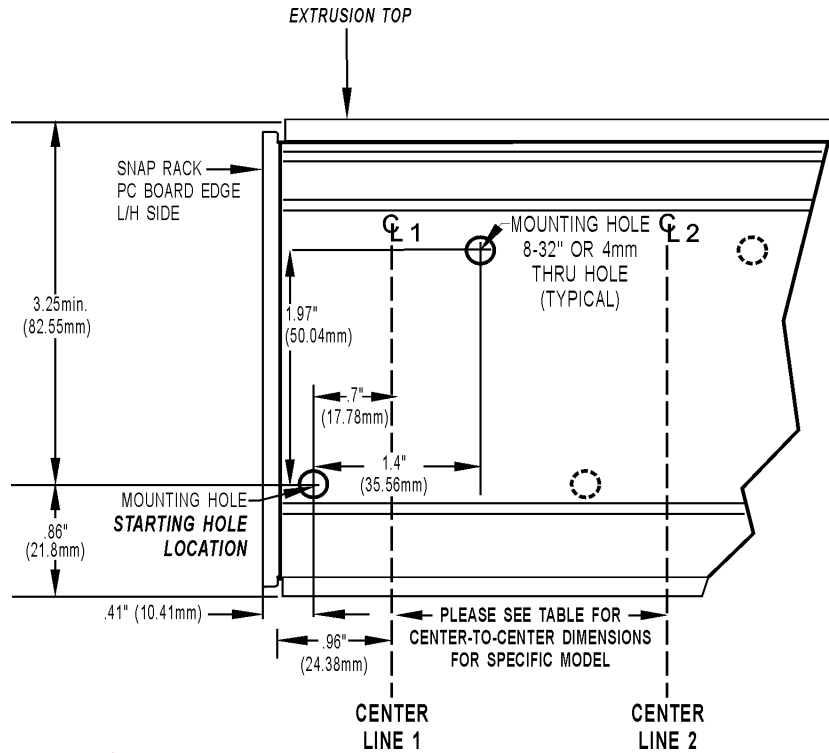

### General Mounting Instructions

The SNAP rack assembly should be mounted horizontally, as shown in diagram, if not using module hold-down screws.

#### Preferred Method: Template (product on site)

1. Use SNAP rack mounting extrusion as template.
2. Be sure to use drawing to determine required product and option clearances.

#### Alternate Method: Prefabrication of Panels (no product on site)

1. Mounting holes are in sets of two located on lower left and upper right, with respect to a centerline (CL).
2. Using the drawing, determine CL1 mounting hole positions. (CL1 is located on the left side of all SNAP rack mounting extrusions.)
3. Use the center-to-center length specification table to determine offset between centerlines and number of centerline positions for each model.
4. Repeat process for each centerline position.
5. Dimensions shown in drawing apply to all models.

#### Center-to-Center Length (All Models)

Part Numbers	Description	Center-to-Center Length (inches)	# of Center Positions
SNAP-D4M	4-module rack	1.98	2
SNAP-D6M	6-module rack	3.53	2
SNAP-D8M	8-module rack	5.53	2
SNAP-D12M	12-module rack	4.26	3



## More About Opto 22

### Products

Opto 22 develops and manufactures reliable, flexible, easy-to-use hardware and software products for industrial automation, energy management, remote monitoring, and data acquisition applications.

#### groov

groov puts your system on your mobile device. With zero programming, you can build mobile operator interfaces to monitor and control systems from Allen-Bradley, Siemens, Schneider Electric, Modicon, and many more. Web-based groov puts mobile-ready gadgets at your fingertips. Tag them from your existing tag database, and they automatically scale for use on any device with a modern web browser. See [groov.com](http://groov.com) for more information and your free trial.

#### SNAP PAC System

Designed to simplify the typically complex process of selecting and applying an automation system, the SNAP PAC System consists of four integrated components:

- SNAP PAC controllers
- PAC Project™ Software Suite
- SNAP PAC brains
- SNAP I/O™

#### SNAP PAC Controllers

Programmable automation controllers (PACs) are multifunctional, modular controllers based on open standards.

Opto 22 has been manufacturing PACs for over two decades. The standalone SNAP PAC S-series, the rack-mounted SNAP PAC R-series, and the software-based SoftPAC™ all handle a wide range of digital, analog, and serial functions for data collection, remote monitoring, process control, and discrete and hybrid manufacturing.

SNAP PACs are based on open Ethernet and Internet Protocol (IP) standards, so you can build or extend a system easily, without the expense and limitations of proprietary networks and protocols. Wired+Wireless™ models are also available.

#### PAC Project Software Suite

Opto 22's PAC Project Software Suite provides full-featured, cost-effective control programming, HMI (human machine interface) development and runtime, OPC server, and database connectivity software for your SNAP PAC System.

Control programming includes both easy-to-learn flowcharts and optional scripting. Commands are in plain English; variables and I/O point names are fully descriptive.

PAC Project Basic offers control and HMI tools and is free for download on our website, [www.opto22.com](http://www.opto22.com). PAC Project

Professional, available for separate purchase, adds one SoftPAC, OptoOPCServer, OptoDataLink, options for controller redundancy or segmented networking, and support for legacy Opto 22 serial *mistic*™ I/O units.

#### SNAP PAC Brains

While SNAP PAC controllers provide central control and data distribution, SNAP PAC brains provide distributed intelligence for I/O processing and communications. Brains offer analog, digital, and serial functions, including thermocouple linearization; PID loop control; and optional high-speed digital counting (up to 20 kHz), quadrature counting, TPO, and pulse generation and measurement.

#### SNAP I/O

I/O provides the local connection to sensors and equipment. Opto 22 SNAP I/O offers 1 to 32 points of reliable I/O per module, depending on the type of module and your needs. Analog, digital, and serial modules are all mixed on the same mounting rack and controlled by the same processor (SNAP PAC brain or rack-mounted controller).

### Quality

Founded in 1974, Opto 22 has established a worldwide reputation for high-quality products. All are made in the U.S.A. at our manufacturing facility in Temecula, California. Because we test each product twice before it leaves our factory, rather than only testing a sample of each batch, we can guarantee most solid-state relays and optically isolated I/O modules for life.

### Free Product Support

Opto 22's California-based Product Support Group offers free, comprehensive technical support for Opto 22 products. Our staff of support engineers represents decades of training and experience. Support is available in English and Spanish by phone or email, Monday–Friday, 7 a.m. to 5 p.m. PST.

Additional support is always available on our website: how-to videos, OptoKnowledgeBase, self-training guide, troubleshooting and user's guides, and OptoForums.

In addition, hands-on training is available for free at our Temecula, California headquarters, and you can [register online](#).

### Purchasing Opto 22 Products

Opto 22 products are sold directly and through a worldwide network of distributors, partners, and system integrators. For more information, contact Opto 22 headquarters at 800-321-6786 or 951-695-3000, or visit our website at [www.opto22.com](http://www.opto22.com).

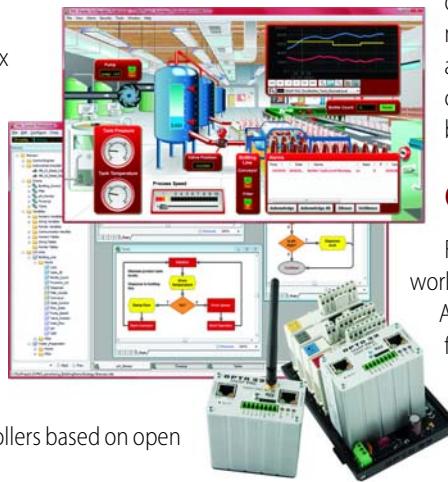

[www.opto22.com](http://www.opto22.com)

## X-ON Electronics

Largest Supplier of Electrical and Electronic Components

*Click to view similar products for [opto 22 manufacturer](#):*

Other Similar products are found below :

[G4AC5](#) [G4PB8H](#) [DC200MP](#) [E2](#) [PB16C](#) [240D10-17](#) [AD6T](#) [DA3](#) [SNAP-PS5-24DC](#) [SNAP-ODC5SNK](#) [SNAP-AOVA-8](#) [PB4H](#) [SNAP-AIV](#)  
[SNAP-AITM-4I](#) [SNAP-AIMA-I](#) [GRV-EPIC-CHS4](#) [GRV-EPIC-PSDC](#) [GRV-EPIC-PSPT](#) [GRV-IAC-24](#) [GRV-IACDCTTL-24](#) [GRV-IACHV-](#)  
[24](#) [GRV-IACHVS-24](#) [GRV-IACI-12](#) [GRV-IACIHV-12](#) [GRV-IACIHVS-12](#) [GRV-IACIS-12](#) [GRV-IACS-24](#) [GRV-IDC-24](#) [GRV-IDCIS-12](#)  
[GRV-IDCS-24](#) [GRV-IMA-24](#) [GRV-ITMI-8](#) [GRV-OAC-12](#) [GRV-OACI-12](#) [GRV-OACIS-12](#) [GRV-OACS-12](#) [GRV-ODCIS-12](#) [GRV-](#)  
[OMRIS-8](#) [AD10T2](#) [AD8T](#) [DA8](#) [IAC15](#) [SNAP-PAC-EB1-FM](#) [FUSEG4B](#) [120D45](#) [DA4](#) [SNAP-B16MC](#) [AD12](#) [G4AD3](#) [B5](#)