

- 1 **Very compact units**
- 1 **Easy tube insertion for rapid assembly of pneumatic circuits**
- 1 **Positive tube anchorage**
- 1 **All taper threads pre-coated with non-PTFE based sealant**
- 1 **Straight Adaptors feature internal hexagon for Allen key**
- 1 **Silicone free O-rings**



Technical Data

Medium:

Compressed air
(For other media please consult Technical Department)

Operating Pressure:

Vacuum – 18 bar
(Dependent upon operating specification of tubing)

Vacuum: = –750mm of Hg i.e. 98%

Operating Temperature:

–20°C* to +80°C
(–20°C to +200°C with Viton O-ring - add suffix V)

Tube Sizes

1/8", 5/32", 3/16", 1/4", 5/16", 3/8", 1/2" O/D

Tubing Types:

Nylon 11 or 12, Polyurethane and other plasticised or unplasticised tubing which conforms to the tolerances specified in BS 5409, Part 1, 1976, light and normal duty, DIN 73378, DIN 74234, NFE 49-100

Materials

Nickel plated brass or glass filled nylon for body
Nickel plated brass for collet.
Silicone free nitrile rubber 'O' ring (Viton optional).
Plastic sealing washer (parallel threads)
Non - PTFE thread sealant.

Note that dimensions in this section are in Imperial units unless otherwise stated.

Ordering Information

To order, quote appropriate product number from the tables on the following pages.



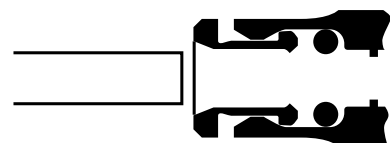
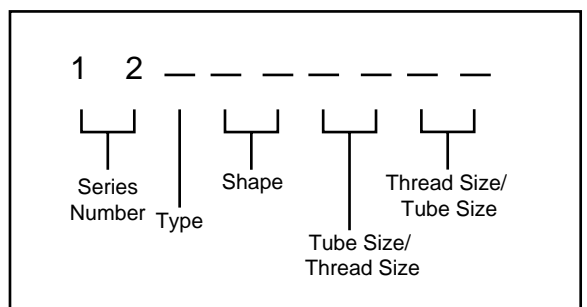









Pneufit's new product numbering system is designed to make identification and selection simple:









Warning: The push-in tube fittings in this section must not be used in vehicle air braking systems. For push-in fittings suited to these applications please consult our Technical Service for details.















Straight Unions, Connectors and Adaptors

UNION  12020 Page 9.3.010.03	UNION Inch tube to MM Tube  10020/10037 Page 9.3.010.09	DOUBLE MALE UNION (BRASS)  12022 Page 9.3.010.03	BULKHEAD UNION  12029 Page 9.3.010.04	MALE CONNECTOR  12425 Page 9.3.010.05	MALE CONNECTOR Inch O/D Tube to BSPT Thread  10125/12125 Page 9.3.010.05	MALE CONNECTOR MM O/D Tube to NPTF [Male] Thread  10425/12425 Page 9.3.010.05
FEMALE CONNECTOR  12426 Page 9.3.010.04	STEM ADAPTOR  12415 Page 9.3.010.04	STEM ADAPTOR Inch O/D Stem to BSPT Thread  10115/12115 Page 9.3.010.04	STEM ADAPTOR MM O/D Stem to NPTF [Male] Thread  10415/12415 Page 9.3.010.09	BARB ADAPTOR  12019 Page 9.3.010.03		





Elbow Unions and Connectors and Banjos

UNION ELBOW  12040 Page 9.3.010.06	MALE ELBOW  12445 Page 9.3.010.07	SWIVEL MALE ELBOW  12477 Page 9.3.010.06	EXTENDED SWIVEL MALE ELBOW  12454 Page 9.3.010.07	SWIVEL FEMALE ELBOW  12448 Page 9.3.010.06	BANJO ELBOW  12R51 Page 9.3.010.08	FIXED ELBOW ADAPTOR  12145 Page 9.3.010.06
--	---	--	---	--	--	--

Tee Unions, Connectors and Banjos, 'Y' Unions and Connectors

UNION TEE  12060 Page 9.3.010.07	SWIVEL MALE BRANCH TEE  12467 Page 9.3.010.08	SWIVEL MALE RUN TEE  12468 Page 9.3.010.08	ISO G BANJO TEE  12R71 Page 9.3.010.09	PARALLEL UNION Y CONNECTOR (Thermoplastic)  12082 Page 9.3.010.08	SWIVEL TEE ADAPTOR  12167/10167 Page 9.3.010.07	SWIVEL SIDE TEE ADAPTOR  12168/10168 Page 9.3.010.07
PARALLEL MALE Y CONNECTOR  12084 Page 9.3.010.08	PARALLEL MALE Y CONNECTOR (Plastic)  12084 Page 9.3.010.05	PARALLEL MALE Y SWIVEL (Plastic)  12488 Page 9.3.010.09	ELBOW BANJO ASSEMBLY  12V0 Page 9.3.010.10	ELBOW BANJO ASSEMBLY  12VA0 Page 9.3.010.10		

Accessories

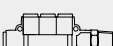
TUBE END EXPANDER/REDUCER  12023 Page 9.3.010.03	PLUG  12004 Page 9.3.010.04	PLUG (Plastic)  13004 Page 9.3.010.04	MANIFOLD O/D tube to O/D tube  120D6 Page 9.3.010.11	MANIFOLD O/D tube to male NPTF thread  124D6 Page 9.3.010.11		
---	---	---	---	--	--	--



Assembly Details

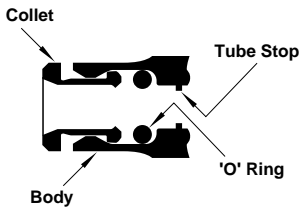

Typical Dimensions

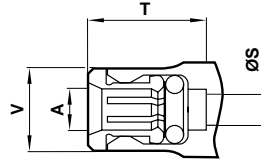

A O/D tube	S	T tubing stop	V
1/8"	0,09	0,53	0,26
5/32"(4)	0,11	0,55	0,30
3/16"	0,13	0,59	0,38
1/4"	0,17	0,61	0,42
5/16"(8)	0,24	0,65	0,51
3/8"	0,30	0,83	0,59
1/2"	0,38	0,96	0,71

* Dimensions here and in the individual tables refer to the collet being in the 'IN' position.

† Dimensions here (minimum bore diameter) are common per tube size for all Connectors, Elbows and Tees unless otherwise stated.

Method of Assembly

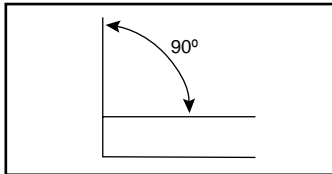

1. Ensure that the end of the tube is cut square and is free from burrs.

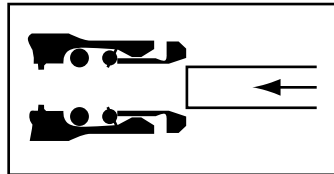

2. Push the tube through the collet into the fitting.

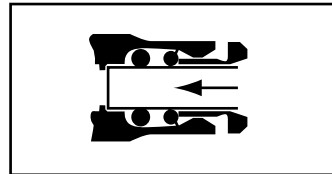

3. Push the tube firmly through the 'O' ring until it bottoms on the tube stop then pull back.

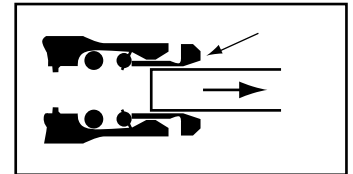

4. To disconnect, push the tube into the fitting, hold down the collet and withdraw the tube.

Straight Stem Connector

12022

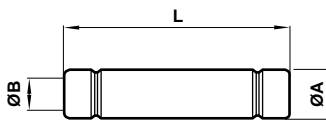

Product number	A O/D Stem	B	L
12 022 0100	1/8"	0,09	1,18
12 022 0200	5/32"	0,13	1,19
12 022 0300	3/16"	0,16	1,31
12 022 0400	1/4"	0,24	1,34
12 022 0500	5/16"	0,30	1,42
12 022 0600	3/8"	0,38	1,77
12 022 0700	1/2"	0,45	2,05

Straight Connector

O/D tube to O/D tube

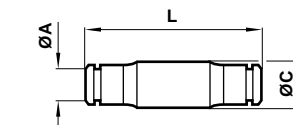

12020

Product number	A O/D Tube	L	C
12 020 0100	1/8"	1,15	0,35
12 020 0200	5/32"	1,17	0,39
12 020 0300	3/16"	1,26	0,43
12 020 0400	1/4"	1,28	0,47
12 020 0500	5/16"	1,35	0,55
12 020 0600	3/8"	1,71	0,67
12 020 0700	1/2"	1,98	0,81

Tube End Expander/Reducer

tube stem to O/D tube

12023

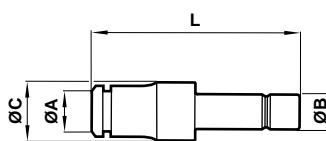

Reducing

Product number	A O/D Tube	B O/D Stem	L	C
12 023 0201	1/8"	5/32"	1,22	0,35
12 023 0401	1/8"	1/4"	1,30	0,35
12 023 0402	5/32"	1/4"	1,34	0,39
12 023 0502	5/32"	5/16"	1,22	0,39
12 023 0602	5/32"	3/8"	1,22	0,47
12 023 0403	3/16"	1/4"	1,38	0,43
12 023 0503	3/16"	5/16"	1,30	0,43
12 023 0504	1/4"	5/16"	1,46	0,47
12 023 0604	1/4"	3/8"	1,50	0,47
12 023 0704	1/4"	1/2"	1,38	0,55
12 023 0605	5/16"	3/8"	1,69	0,55
12 023 0705	5/16"	1/2"	1,65	0,55
12 023 0706	3/8"	1/2"	1,97	0,67

Expanding

Product number	A O/D Tube	B O/D Stem	L	C
12 023 0104	1/4"	1/8"	1,34	0,47
12 023 0204	1/4"	5/32"	1,38	0,47
12 023 0304	1/4"	3/16"	1,40	0,47

Stem Tailpiece Adaptor

O/D tube stem to hose bore

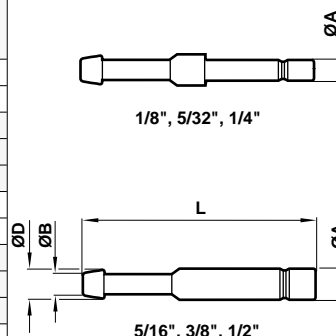

12019

Product number	A O/D Stem	B Hose Bore	L	D (ref)
12 019 0101	1/8"	1/8"	0,17	1,34
12 019 0201	5/32"	1/8"	0,17	1,35
12 019 0403	1/4"	3/16"	0,24	1,43
12 019 0504	5/16"	1/4"	0,31	1,47
12 019 0605	3/8"	5/16"	0,37	1,70
12 019 0706	1/2"	3/8"	0,47	1,84



Bulkhead Connector
O/D tube to O/D tube

12029

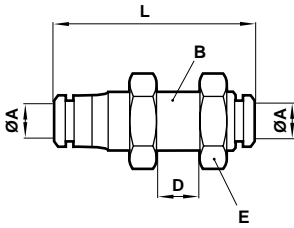

Product number	A O/D Tube	B Metric Thread	E A/F	D	L
12 029 0100	1/8"	M10 x 1.0	0,55	0,47	1,15
12 029 0200	5/32"	M10 x 1.0	0,55	0,47	1,18
12 029 0300	3/16"	M12 x 1.0	0,67	0,55	1,26
12 029 0400	1/4"	M14 x 1.5	0,75	0,59	1,38
12 029 0500	5/16"	M16 x 1.5	0,87	0,63	1,42
12 029 0600	3/8"	M20 x 1.5	1,06	0,55	1,69
12 029 0700	1/2"	M24 x 1.5	1,18	0,59	1,97

Plug

12004

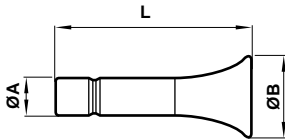

Product number	A O/D Stem	B Ø	L
12 004 0100	1/8"	0,34	1,02
12 004 0200	5/32"	0,38	1,04
12 004 0300	3/16"	0,42	1,10
12 004 0400	1/4"	0,46	1,12
12 004 0500	5/16"	0,50	1,16
12 004 0600	3/8"	0,61	1,34
12 004 0700	1/2"	0,66	1,48

Nickel plated brass

Plug

13004

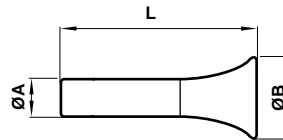

Product number	A O/D Stem	B Ø	L
13 004 0200	5/32"	0,38	1,04
13 004 0300	3/16"	0,41	1,10
13 004 0400	1/4"	0,46	1,12
13 004 0500	5/16"	0,50	1,16
13 004 0600	3/8"	0,61	1,34
13 004 0700	1/2"	0,65	1,48

Plastic

Stem Adaptor
Inch O/D Stem to BSPT Thread

10115/12115

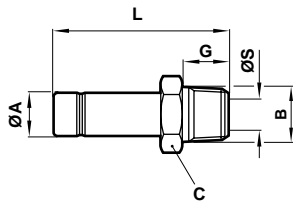

Product number	A O/D Stem	B ISO R Thread	C A/F	G	L	S
10 115 0418	5/32"	1/8"	0,39	0,30	1,18	0,08
10 115 0428	5/32"	1/4"	0,55	0,44	1,32	0,08
12 115 0418	1/4"	1/8"	0,47	0,30	1,26	0,16
12 115 0428	1/4"	1/4"	0,55	0,44	1,40	0,16
10 115 0818	5/16"	1/8"	0,55	0,30	1,30	0,20
10 115 0828	5/16"	1/4"	0,55	0,44	1,44	0,20
12 115 0628	3/8"	1/4"	0,59	0,44	1,57	0,30
12 115 0638	3/8"	3/8"	0,75	0,50	1,77	0,30
12 115 0738	1/2"	3/8"	0,75	0,50	1,89	0,39
12 115 0748	1/2"	1/2"	0,87	0,63	2,03	0,39

Straight Stem Adaptor
O/D tube stem to taper NPTF thread

12415

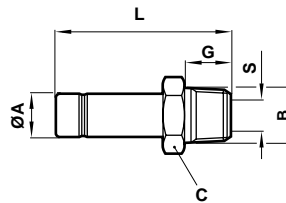

Product number	A O/D Stem	B NPTF Thread	C A/F	G	L	S
12 415 0210	5/32"	10-32	5/16"	0,20	1,14	0,08
12 415 0218	5/32"	1/8"	7/16"	0,37	1,25	0,08
12 415 0228	5/32"	1/4"	9/16"	0,56	1,45	0,08
12 415 0418	1/4"	1/8"	7/16"	0,37	1,33	0,16
12 415 0428	1/4"	1/4"	9/16"	0,56	1,52	0,16
12 415 0518	5/16"	1/8"	7/16"	0,37	1,37	0,19
12 415 0528	5/16"	1/4"	9/16"	0,56	1,56	0,19
12 415 0628	3/8"	1/4"	9/16"	0,56	1,74	0,30
12 415 0638	3/8"	3/8"	11/16"	0,56	1,82	0,30
12 415 0738	1/2"	3/8"	11/16"	0,56	1,95	0,35
12 415 0748	1/2"	1/2"	7/8"	0,75	2,15	0,35



Straight Adaptor

10425/12425

MM O/D Tube to NPTF (Male) Thread

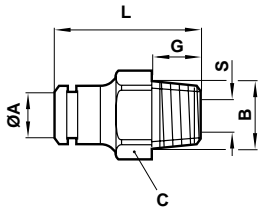

Product number	A O/D (mm)	B Thread	C A/F	G	L	S Hex
12 425 0210	4	10/32"UNF	.350	0,20	0,85	3/32"
12 425 0218	4	1/8"	7/16"	0,37	0,89	1/8"
12 425 0228	4	1/4"	9/16"	0,56	1,04	1/8"
10 425 0518	5	1/8"	7/16"	0,37	0,96	5/32"
10 425 0528	5	1/4"	9/16"	0,56	1,04	5/32"
10 425 0610	6	10/32"UNF	0,430	0,20	0,94	5/32"
10 425 0618	6	1/8"	7/16"	0,37	0,98	5/32"
10 425 0628	6	1/4"	9/16"	0,56	1,11	5/32"
10 425 0638	6	3/8"	1 1/16"	0,56	1,07	5/32"
12 425 0518	8	1/8"	1/2"	0,37	1,12	3/16"
12 425 0528	8	1/4"	9/16"	0,56	1,23	1/4"
12 425 0538	8	3/8"	1 1/16"	0,56	1,13	1/4"
10 425 1018	10	1/8"	1 1/16"	0,37	1,32	3/16"
10 425 1028	10	1/4"	1 1/16"	0,56	1,47	9/32"
10 425 1038	10	3/8"	1 1/16"	0,56	1,41	5/16"
10 425 1048	10	1/2"	7/8"	0,75	1,45	5/16"
10 425 1228	12	1/4"	7/8"	0,56	1,67	9/32"
10 425 1238	12	3/8"	7/8"	0,56	1,63	13/32"
10 425 1248	12	1/2"	7/8"	0,75	1,70	13/32"

Straight Adaptor

10125/12125

Inch O/D Tube to BSPT Thread

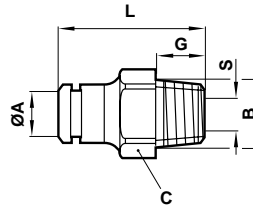

Product number	A O/D Tube	B ISO R Thread	C A/F	G	L
12 125 0118	1/8"	1/8"	0,39	0,30	0,79
12 125 0128	1/8"	1/4"	0,55	0,44	0,89
10 125 0418	5/32"	1/8"	0,39	0,30	0,81
10 125 0428	5/32"	1/4"	0,55	0,44	0,91
12 125 0418	1/4"	1/8"	0,43	0,30	0,91
12 125 0428	1/4"	1/4"	0,55	0,44	0,99
12 125 0438	1/4"	3/8"	0,67	0,50	1,01
10 125 0818	5/16"	1/8"	0,51	0,30	1,05
10 125 0828	5/16"	1/4"	0,55	0,44	1,11
10 125 0838	5/16"	3/8"	0,67	0,50	1,07
12 125 0618	3/8"	1/8"	0,67	0,30	1,25
12 125 0628	3/8"	1/4"	0,67	0,44	1,35
12 125 0638	3/8"	3/8"	0,67	0,50	1,35
12 125 0648	3/8"	1/2"	0,87	0,63	1,33
12 125 0728	1/2"	1/4"	0,87	0,44	1,54
12 125 0738	1/2"	3/8"	0,87	0,50	1,56
12 125 0748	1/2"	1/2"	0,87	0,63	1,58

Straight Adaptor

12425

O/D tube to male NPTF taper

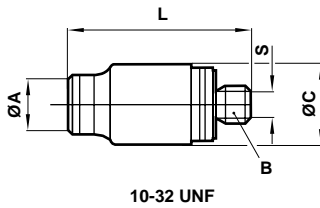

10-32 UNF

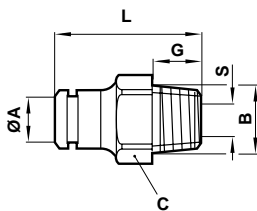

Product number	A O/D Tube	B NPTF or UNF Thread	C	G	L	S Hex
12 425 0110	1/8"	10-32 UNF	0,31	0,20	0,79	3/32"
12 425 0116	1/8"	1/16"	3/8"	0,37	0,80	3/32"
12 425 0118	1/8"	1/8"	7/16"	0,37	0,67	3/32"
12 425 0128	1/8"	1/4"	9/16"	0,56	0,95	3/32"
12 425 0210	5/32"	10-32 UNF	0,35	0,20	0,85	3/32"
12 425 0218	5/32"	1/8"	7/16"	0,37	0,89	1/8"
12 425 0228	5/32"	1/4"	9/16"	0,56	1,04	1/8"
12 425 0318	3/16"	1/8"	7/16"	0,37	0,96	5/32"
12 425 0328	3/16"	1/4"	9/16"	0,56	1,04	5/32"
12 425 0410	1/4"	10-32 UNF	0,43	0,20	0,94	3/32"
12 425 0418	1/4"	1/8"	7/16"	0,37	0,98	5/32"
12 425 0428	1/4"	1/4"	9/16"	0,56	1,11	5/32"
12 425 0438	1/4"	3/8"	1 1/16"	0,56	1,07	5/32"
12 425 0518	5/16"	1/8"	1/2"	0,37	1,12	3/16"
12 425 0528	5/16"	1/4"	9/16"	0,56	1,23	1/4"
12 425 0538	5/16"	3/8"	1 1/16"	0,56	1,13	1/4"
12 425 0618	3/8"	1/8"	1 1/16"	0,37	1,32	3/16"
12 425 0628	3/8"	1/4"	1 1/16"	0,56	1,47	1/4"
12 425 0638	3/8"	3/8"	1 1/16"	0,56	1,41	5/16"
12 425 0648	3/8"	1/2"	7/8"	0,75	1,45	5/16"
12 425 0728	1/2"	1/4"	7/8"	0,56	1,67	1/4"
12 425 0738	1/2"	3/8"	7/8"	0,56	1,63	3/8"
12 425 0748	1/2"	1/2"	7/8"	0,75	1,70	3/8"

Straight Adaptor

12426

O/D tube to female NPTF thread

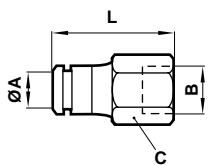

Product number	A O/D Tube	B NPTF Thread	C A/F	L
12 426 0118	1/8"	1/8"	9/16"	1,14
12 426 0128	1/8"	1/4"	1 1/16"	1,38
12 426 0218	5/32"	1/8"	9/16"	1,14
12 426 0228	5/32"	1/4"	1 1/16"	1,42
12 426 0418	1/4"	1/8"	9/16"	1,19
12 426 0428	1/4"	1/4"	1 1/16"	1,46
12 426 0518	5/16"	1/8"	9/16"	1,23
12 426 0528	5/16"	1/4"	1 1/16"	1,50
12 426 0628	3/8"	1/4"	1 1/16"	1,66
12 426 0638	3/8"	3/8"	7/8"	1,70

Straight Adaptor

12225/10225

O/D Tube to Male Metric Thread

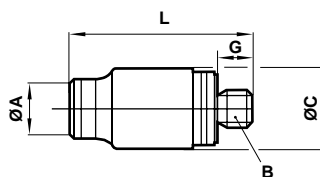

Product number	A O/D Tube	B Thread	C	G	L
12 225 0105	1/8"	M5 x 0.8	0,31	0,2	0,78
10 225 0405	5/32"	M5 x 0.8	0,35	0,2	0,84
12 225 0305	3/16"	M5 x 0.8	0,39	0,2	0,9
12 225 0405	1/4"	M5 x 0.8	0,43	0,2	0,94



Elbow Connector
O/D tube to O/D tube

12040

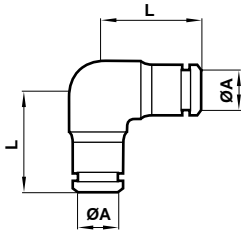

Product number	A O/D Tube	L
12 040 0100	1/8"	0,65
12 040 0200	5/32"	0,67
12 040 0300	3/16"	0,72
12 040 0400	1/4"	0,77
12 040 0500	5/16"	0,84
12 040 0600	3/8"	1,05
12 040 0700	1/2"	1,25

Fixed Elbow Adaptor

O/D Tube to Male BSPT Thread

12145

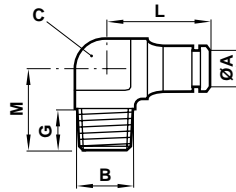

Product number	A O/D Tube	B Thread BSPT	C	G	L	M
12 145 0118	1/8"	1/8"	0,27	0,34	0,66	0,63
12 145 0318	3/16"	1/8"	0,27	0,34	0,72	0,65
12 145 0418	1/4"	1/8"	0,42	0,34	0,77	0,67
12 145 0328	3/16"	1/4"	0,38	0,44	0,78	0,80

Swivel Elbow Adaptor

O/D Tube to Male BSPT Thread

12147/10147

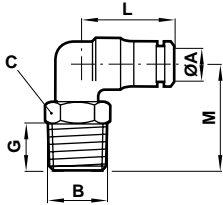

Product number	A O/D Tube	B Thread BSPT	C A/F	G	L	M
12 147 0118	1/8"	1/8"	0,39	0,34	0,63	0,86
10 140 0418	5/32"	1/8"	0,39	0,30	0,66	0,81
12 147 0318	3/16"	1/8"	0,43	0,34	0,73	0,86
12 147 0418	1/4"	1/8"	0,43	0,34	0,77	0,88
10 147 0818	5/16"	1/8"	0,55	0,34	0,84	0,91
10 147 0428	5/32"	1/4"	0,55	0,44	0,66	0,95
12 147 0328	3/16"	1/4"	0,55	0,44	0,72	1,04
12 147 0428	1/4"	1/4"	0,55	0,44	0,77	0,99
10 147 0828	5/16"	1/4"	0,55	0,44	0,84	1,03
12 147 0628	3/8"	1/4"	0,67	0,44	1,05	1,13
12 147 0728	1/2"	1/4"	0,75	0,44	1,25	1,25
12 147 0638	3/8"	3/8"	0,67	0,50	1,05	1,20
12 147 0648	3/8"	1/2"	0,87	0,63	1,25	1,36
12 147 0738	1/2"	3/8"	0,87	0,50	1,05	1,35
12 147 0748	1/2"	1/2"	0,87	0,63	1,25	1,50

Swivel Female Elbow Adaptor

O/D tube to female NPTF thread

12448

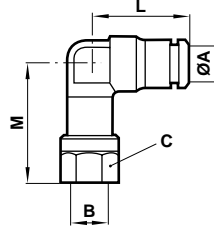

Product number	A O/D Tube	B NPTF Thread	C A/F	L	M
12 448 0118	1/8"	1/8"	9/16"	0,63	1,19
12 448 0218	5/32"	1/8"	9/16"	0,67	1,19
12 448 0228	5/32"	1/4"	11/16"	0,67	1,40
12 448 0418	1/4"	1/8"	9/16"	0,77	1,22
12 448 0428	1/4"	1/4"	11/16"	0,77	1,44
12 448 0528	5/16"	1/4"	11/16"	0,84	1,48
12 448 0628	3/8"	1/4"	11/16"	1,05	1,58
12 448 0738	1/2"	3/8"	7/8"	1,25	1,82

Swivel Male Elbow

O/D tube to male NPTF thread

12477

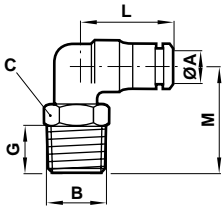

Product number	A O/D Tube	B NPTF or UNF Thread	C A/F	G	L	M
12 477 0110	1/8"	10-32 UNF	5/16"	0,20	0,63	0,73
12 477 0118	1/8"	1/8"	7/16"	0,37	0,63	0,82
12 477 0128	1/8"	1/4"	9/16"	0,37	0,68	1,07
12 477 0210	5/32"	10-32 UNF	5/16"	0,20	0,67	0,77
12 477 0218	5/32"	1/8"	7/16"	0,37	0,67	0,86
12 477 0228	5/32"	1/4"	9/16"	0,56	0,67	1,07
12 477 0318	3/16"	1/8"	7/16"	0,37	0,72	0,88
12 477 0328	3/16"	1/4"	9/16"	0,56	0,72	1,09
12 477 0418	1/4"	1/8"	7/16"	0,37	0,77	0,90
12 477 0428	1/4"	1/4"	9/16"	0,56	0,77	1,11
12 477 0438	1/4"	3/8"	3/4"	0,56	0,80	1,15
12 477 0518	5/16"	1/8"	9/16"	0,37	0,84	0,96
12 477 0528	5/16"	1/4"	9/16"	0,56	0,84	1,15
12 477 0618	3/8"	1/8"	9/16"	0,37	1,05	1,05
12 477 0628	3/8"	1/4"	11/16"	0,56	1,05	1,26
12 477 0638	3/8"	3/8"	3/4"	0,56	1,05	1,26
12 477 0648	3/8"	1/2"	7/8"	0,75	1,05	1,48
12 477 0728	1/2"	1/4"	3/4"	0,56	1,25	1,37
12 477 0738	1/2"	3/8"	3/4"	0,56	1,25	1,41
12 477 0748	1/2"	1/2"	7/8"	0,75	1,25	1,62



Fixed Elbow Adaptor
O/D tube to male NPTF thread

12445

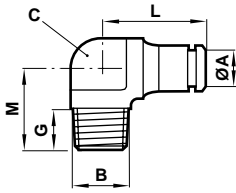

Product number	A O/D Tube	B NPTF Thread	C A/F	G	L	M
12 445 0118	1/8"	1/8"	0,28	0,37	0,67	0,66
12 445 0218	5/32"	1/8"	0,28	0,37	0,67	0,66
12 445 0228	5/32"	1/4"	0,43	0,56	0,72	0,92
12 445 0318	3/16"	1/8"	0,28	0,37	0,72	0,67
12 445 0328	3/16"	1/4"	0,43	0,56	0,79	0,92
12 445 0418	1/4"	1/8"	0,31	0,37	0,77	0,70
12 445 0428	1/4"	1/4"	0,43	0,56	0,79	0,92
12 445 0438	1/4"	3/8"	0,63	0,56	0,84	1,10
12 445 0518	5/16"	1/8"	0,43	0,37	0,84	0,74
12 445 0528	5/16"	1/4"	0,43	0,56	0,84	0,92
12 445 0618	3/8"	1/8"	0,52	0,37	1,05	0,80
12 445 0628	3/8"	1/4"	0,52	0,56	1,05	0,98
12 445 0638	3/8"	3/8"	0,63	0,56	1,05	1,10
12 445 0648	3/8"	1/2"	0,94	0,75	1,13	1,36
12 445 0728	1/2"	1/4"	0,63	0,56	1,25	1,03
12 445 0738	1/2"	3/8"	0,63	0,56	1,25	1,10
12 445 0748	1/2"	1/2"	0,94	0,75	1,25	1,36

Extended Swivel Elbow Adaptor
O/D tube to male NPTF thread

12454

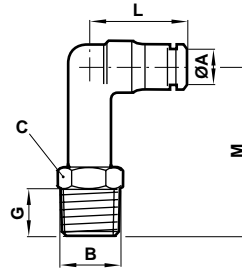

Product number	A O/D Tube	B NPTF Thread	C A/F	G	L	M
12 454 0218	5/32"	1/8"	7/16"	0,37	0,67	1,39
12 454 0228	5/32"	1/4"	7/16"	0,37	0,77	1,49
12 454 0418	1/4"	1/8"	9/16"	0,56	0,67	1,71
12 454 0428	1/4"	1/4"	9/16"	0,56	0,77	1,75
12 454 0628	3/8"	1/4"	11/16"	0,56	1,05	2,10
12 454 0638	3/8"	3/8"	3/4"	0,56	1,05	2,10

Tee Connector
O/D tube to O/D tube

12060

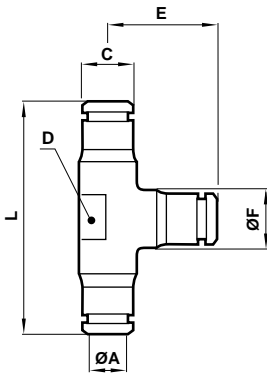

Product number	A O/D Tube	C D A/F	E	F	L
12 060 0100	1/8"	0,26 0,20	0,63	0,32	1,26
12 060 0200	5/32"	0,30 0,28	0,67	0,40	1,34
12 060 0300	3/16"	0,38 0,28	0,72	0,44	1,44
12 060 0400	1/4"	0,42 0,31	0,77	0,48	1,54
12 060 0500	5/16"	0,50 0,43	0,84	0,56	1,68
12 060 0600	3/8"	0,59 0,52	1,05	0,67	2,10
12 060 0700	1/2"	0,71 0,63	1,25	0,81	2,50

Swivel Tee Adaptor
O/D Tube to Male Taper BSP Thread

12167/10167

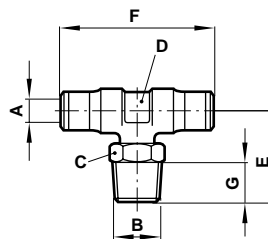

Product number	A O/D Tube	B Thread BSPT	C A/F	D A/F	E	F	G
10 167 0418	5/32"	1/8"	0,39	0,28	0,81	1,33	0,34
12 167 0318	3/16"	1/8"	0,34	0,35	0,86	1,45	0,34
12 167 0418	1/4"	1/8"	0,34	0,35	0,88	1,54	0,34
10 167 0818	5/16"	1/8"	0,55	0,43	0,91	1,68	0,34
10 167 0428	5/32"	1/4"	0,55	0,28	0,95	1,33	0,44
12 167 0328	3/16"	1/4"	0,43	0,34	0,97	1,45	0,44
12 167 0428	1/4"	1/4"	0,43	0,35	0,99	1,54	0,44
10 167 0828	5/16"	1/4"	0,55	0,43	1,03	1,68	0,44
12 167 0618	3/8"	1/4"	0,43	0,52	1,13	2,10	0,44
12 167 0728	1/2"	1/4"	0,43	0,63	1,25	2,50	0,44
12 167 0638	3/8"	3/8"	0,50	0,52	1,20	2,10	0,50
12 167 0738	1/2"	3/8"	0,50	0,63	1,34	2,50	0,50

Swivel Side Tee Adaptor **12168/10168**

O/D Tube to Male Taper BSP Thread

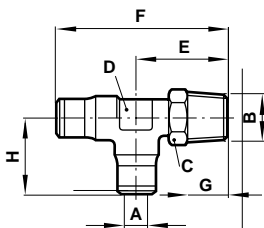

Product number	A O/D Tube	B Thread BSPT	C A/F	D A/F	E	F	G	H
10 168 0418	5/32"	1/8"	0,39	0,28	0,81	1,47	0,34	0,66
12 168 0318	3/16"	1/8"	0,34	0,35	0,86	1,59	0,34	0,72
12 168 0418	1/4"	1/8"	0,34	0,35	0,88	1,65	0,34	0,77
10 168 0818	5/16"	1/8"	0,55	0,43	0,91	1,74	0,34	0,84
10 168 0428	5/32"	1/4"	0,55	0,28	0,95	1,61	0,44	0,72
12 168 0328	3/16"	1/4"	0,43	0,34	0,97	1,69	0,44	0,72
12 168 0428	1/4"	1/4"	0,43	0,35	1,00	1,76	0,44	0,77
10 168 0828	5/16"	1/4"	0,55	0,43	1,03	1,87	0,44	0,84
12 168 0628	3/8"	1/4"	0,43	0,52	1,13	2,19	0,44	1,05
12 168 0728	1/2"	1/4"	0,43	0,63	1,25	2,50	0,44	1,24
12 168 0638	3/8"	3/8"	0,50	0,52	1,20	2,25	0,50	1,05
12 168 0738	1/2"	3/8"	0,50	0,63	1,34	2,59	0,50	1,25



Swivel Male Centre Tee
O/D tube to male NPTF thread

12467

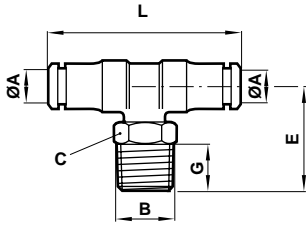

Swivel Male Side Tee
O/D tube to male taper NPTF thread

12468

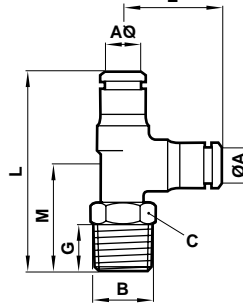

Product number	A O/D Tube	B NPTF or UNF Thread	C A/F	G	L	E
12 467 0110	1/8"	10-32 UNF	5/16"	0,20	1,25	0,73
12 467 0118	1/8"	1/8"	7/16"	0,37	1,26	0,81
12 467 0128	1/8"	1/4"	9/16"	0,56	1,34	1,07
12 467 0210	5/32"	10-32 UNF	5/16"	0,20	1,34	0,77
12 467 0218	5/32"	1/8"	7/16"	0,37	1,33	0,86
12 467 0228	5/32"	1/4"	9/16"	0,56	1,33	1,07
12 467 0318	3/16"	1/8"	7/16"	0,37	1,45	0,88
12 467 0328	3/16"	1/4"	9/16"	0,56	1,45	1,09
12 467 0418	1/4"	1/8"	7/16"	0,37	1,54	0,90
12 467 0428	1/4"	1/4"	9/16"	0,56	1,54	1,12
12 467 0438	1/4"	3/8"	3/4"	0,56	1,57	1,20
12 467 0518	5/16"	1/8"	9/16"	0,37	1,68	0,96
12 467 0528	5/16"	1/4"	9/16"	0,56	1,68	1,15
12 467 0618	3/8"	1/8"	9/16"	0,37	2,10	0,66
12 467 0628	3/8"	1/4"	1 1/16"	0,56	2,10	1,26
12 467 0638	3/8"	3/8"	3/4"	0,56	2,10	1,26
12 467 0648	3/8"	1/2"	7/8"	0,75	2,10	1,48
12 467 0728	1/2"	1/4"	3/4"	0,56	2,50	1,37
12 467 0738	1/2"	3/8"	3/4"	0,56	2,50	1,41
12 467 0748	1/2"	1/2"	7/8"	0,75	2,50	1,62

Product number	A O/D Tube	B NPTF or UNF Thread	C A/F	G	L	M	E
12 468 0110	1/8"	10-32 UNF	5/16"	0,63	1,36	0,63	1,36
12 468 0118	1/8"	1/8"	7/16"	0,63	1,36	0,73	0,63
12 468 0128	1/8"	1/4"	9/16"	0,67	1,44	0,77	0,67
12 468 0210	5/32"	10-32 UNF	5/16"	0,67	1,44	0,67	1,44
12 468 0218	5/32"	1/8"	7/16"	0,67	1,52	0,86	0,67
12 468 0228	5/32"	1/4"	9/16"	0,67	1,73	1,07	0,67
12 468 0318	3/16"	1/8"	7/16"	0,72	1,60	0,88	0,72
12 468 0328	3/16"	1/4"	9/16"	0,72	1,81	1,09	0,72
12 468 0418	1/4"	1/8"	7/16"	0,77	1,67	0,90	0,77
12 468 0428	1/4"	1/4"	9/16"	0,77	1,88	1,11	0,77
12 468 0438	1/4"	3/8"	3/4"	0,79	1,59	0,81	0,79
12 468 0518	5/16"	1/8"	9/16"	0,84	1,80	0,96	0,84
12 468 0528	5/16"	1/4"	9/16"	0,84	1,98	1,15	1,98
12 468 0618	3/8"	1/8"	9/16"	1,05	2,00	0,94	1,05
12 468 0628	3/8"	1/4"	1 1/16"	1,05	2,31	1,26	1,05
12 468 0638	3/8"	3/8"	3/4"	1,05	2,31	1,26	1,05
12 468 0648	3/8"	1/2"	7/8"	1,05	2,53	1,48	1,05
12 468 0728	1/2"	1/4"	3/4"	1,25	2,62	1,37	1,25
12 468 0738	1/2"	3/8"	3/4"	1,25	2,65	1,41	1,25
12 468 0748	1/2"	1/2"	7/8"	1,25	2,87	1,62	1,25

Parallel Y Connector
O/D tube to O/D tube

12082

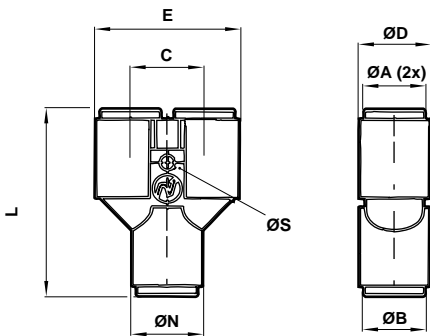

Parallel Y Stem Connector
stem to O/D tube

12084

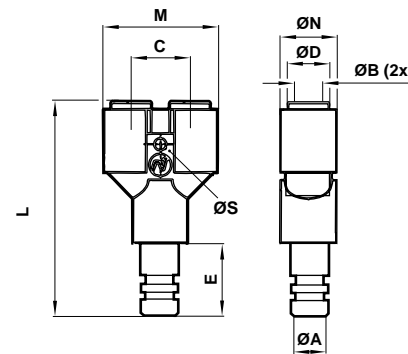

Product number	A O/D Stem	B O/D Tube	C	D Ø	E	L	N Ø	S Ø
12 082 0200	5/32"	5/32"	0,43	0,30	0,87	1,34	0,43	0,13
12 082 0402	5/32"	1/4"	0,55	0,43	1,06	1,50	0,51	0,13
12 082 0400	1/4"	1/4"	0,55	0,43	1,06	1,51	0,51	0,13
12 082 0500	5/16"	5/16"	0,63	0,51	1,22	1,59	0,59	0,13

Product number	A O/D Stem	B O/D Tube	C	D Ø	E	L	M	N Ø	S Ø
12 084 0202	5/32"	5/32"	0,43	0,30	0,71	2,05	0,89	0,45	0,13
12 084 0402	1/4"	5/32"	0,43	0,30	0,73	2,23	0,89	0,45	0,13
12 084 0404	1/4"	1/4"	0,55	0,43	0,73	2,23	1,10	0,55	0,13
12 084 0505	5/16"	5/16"	0,63	0,51	0,77	2,36	1,26	0,63	0,13

Plastic body

Plastic body



Parallel Male Y Swivel Adaptor 12448

O/D tube to male NPTF thread

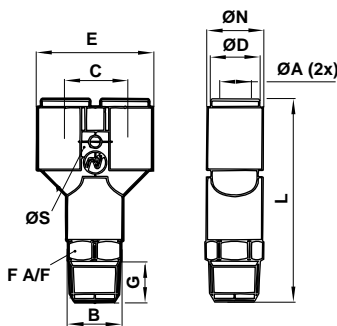

Product number	A O/D Tube	B NPTF Thread	C	D Ø	E	F A/F	G	L	N Ø	S Ø
12 448 0218	5/32"	1/8"	0,43	0,30	0,89	7/16	0,30	1,72	0,45	0,13
12 448 0228	5/32"	1/4"	0,43	0,30	0,89	9/16	0,44	2,01	0,45	0,13
12 448 0418	1/4"	1/8"	0,55	0,43	1,10	7/16	0,30	1,90	0,55	0,13
12 448 0428	1/4"	1/4"	0,55	0,43	1,10	9/16	0,44	2,15	0,55	0,13
12 448 0628	3/8"	1/4"	0,86	0,51	1,67	3/4	0,44	2,69	0,79	0,13
12 448 0638	3/8"	3/8"	0,86	0,51	1,67	3/4	0,56	2,69	0,79	0,13
12 448 0648	3/8"	1/2"	0,86	0,51	1,67	7/8	0,75	2,88	0,79	0,13

Plastic body

Elbow Banjo Assembly 12R51

Non regulating bolt

O/D tube to male NPTF thread

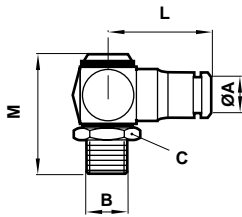

Product number	A O/D Tube	B NPTF or UNF Thread	C A/F	M	L
12 R51 0118	1/8"	1/8"	9/16"	1,22	0,80
12 R51 0210	5/32"	10-32 UNF	5/16"	0,87	0,74
12 R51 0218	5/32"	1/8"	9/16"	1,22	0,81
12 R51 0418	1/4"	1/8"	9/16"	1,22	0,93
12 R51 0428	1/4"	1/4"	11/16"	1,50	0,95
12 R51 0438	1/4"	3/8"	7/8"	1,74	1,03
12 R51 0628	3/8"	1/4"	11/16"	1,50	1,19
12 R51 0638	3/8"	3/8"	7/8"	1,74	1,23

Tee Banjo Assembly 12R71

O/D tube to male BSPP thread

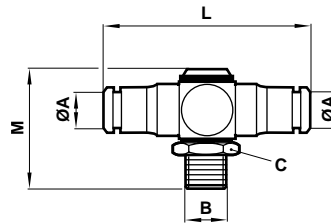

Product number	A O/D Tube	B ISO G	C A/F	M	L
12 R71 0210	5/32"	10-32 UNF	5/16"	0,87	1,48
12 R71 0418	1/4"	1/8"	9/16"	1,22	1,86
12 R71 0428	1/4"	1/4"	11/16"	1,50	1,90
12 R71 0628	3/8"	1/4"	11/16"	1,50	2,38
12 R71 0638	3/8"	3/8"	7/8"	1,74	2,46

Straight Connector 10020/12037

Inch tube to MM tube

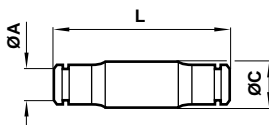

Product number	A O/D Tube	C Ø (mm)	L
10 020 0400	5/32"	4	1,17
12 037 0305	3/16"	5	1,26
12 037 0406	1/4"	6	1,28
10 020 0800	5/16"	8	1,35
12 037 0610	3/8"	10	1,71
12 037 0712	1/2"	12	1,98

Stem Adaptor 10415/12415

MM O/D Stem to NPTF (Male) Thread

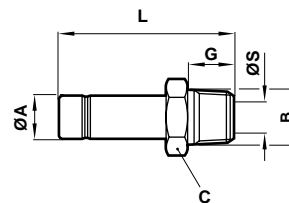

Product number	A O/D Stem (mm)	B NPTF Thread	C A/F	G	L	S
12 415 0218	4	1/8"	7/16"	0,37	1,25	0,08
12 415 0228	4	1/4"	9/16"	0,56	1,44	0,08
10 415 0518	5	1/8"	7/16"	0,37	1,31	0,13
10 415 0528	5	1/4"	9/16"	0,56	1,50	0,13
10 415 0618	6	1/8"	7/16"	0,37	1,33	0,16
10 415 0628	6	1/4"	9/16"	0,56	1,52	0,16
12 415 0518	8	1/8"	7/16"	0,37	1,37	0,20
12 415 0528	8	1/4"	9/16"	0,56	1,56	0,20
10 415 1028	10	1/4"	9/16"	0,56	1,74	0,30
10 415 1038	10	3/8"	11/16"	0,56	1,81	0,30
10 415 1238	12	3/8"	11/16"	0,56	1,95	0,36
10 415 1248	12	1/2"	7/8"	0,75	2,15	0,36



Elbow Banjo Assembly

Regulating Out
O/D tube to male NPTF or
UNF thread
Pressure rating on this item
10 bar

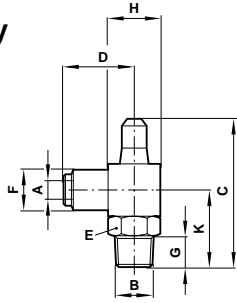

12V0

Elbow Banjo Assembly

Regulating Out
O/D tube to male NPTF or
UNF thread
Knurled adjustment knob
Pressure rating on this item
10 bar

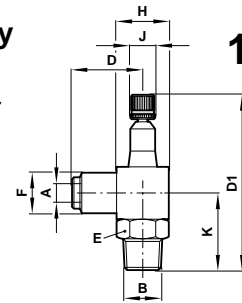

12VA

Product number	A O/D tube	B thr'd	C	D	E A/F	F	G	H	K Square
* 12V000210	⁵ / ₃₂	10-32UNF	27	18,7	-	9,5	4,4	-	-
12V000218	⁵ / ₃₂	¹ / ₈	42	22,0	⁹ / ₁₆	11,5	10	16	22,5
12V000418	¹ / ₄	¹ / ₈	42	23,0	⁹ / ₁₆	13	10	16	22,5
12V000428	¹ / ₄	¹ / ₄	54	25,5	¹¹ / ₁₆	13,5	14,5	20	29,5
12V000628	³ / ₈	¹ / ₄	54	31,5	¹¹ / ₁₆	19,5	14,5	20	29,5
12V000638	³ / ₈	³ / ₈	64	32,5	³ / ₄	19,5	14,5	22	33,0
12V000748	¹ / ₂	¹ / ₂	72	38,0	⁷ / ₈	23,0	19,0	27	42,0

Plastic Body
* Brass Body
Metric dimensions

Product number	A O/D tube	B	D1 Closed	D	E A/F	F	J	H	K Square
* 12VA00210	⁵ / ₃₂	10-32UNF	-	26,5	-	9,5	18,7	2,5	-
12VA00218	⁵ / ₃₂	¹ / ₈	53	22,0	⁹ / ₁₆	11,5	9,0	16,0	22,5
12VA00418	¹ / ₄	¹ / ₈	53	23,0	⁹ / ₁₆	13,0	9,0	16,0	22,5
12VA00428	¹ / ₄	¹ / ₄	67	25,5	¹¹ / ₁₆	13,5	11,0	20,0	29,5
12VA00628	³ / ₈	¹ / ₄	67	31,5	¹¹ / ₁₆	19,5	11,0	20,0	29,5
12VA00638	³ / ₈	³ / ₈	78	32,5	³ / ₄	19,5	13,0	22,0	33,0
12VA00748	¹ / ₂	¹ / ₂	93	38,0	⁷ / ₈	23,0	18,0	27,0	42,0

Plastic Body
* Brass Body
Metric dimensions



Manifold

O/D tube to O/D tube

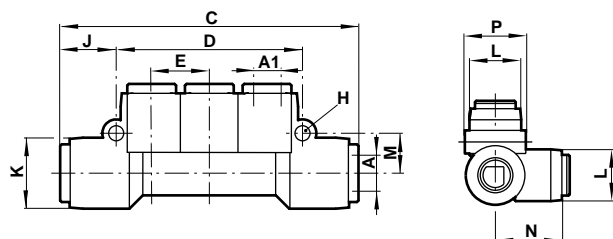

Product number	A O/D tube inlet	A1 O/D tube outlet	C	D	E	H	J	K	L	M	N	P
120D60402	1/4	5/32	69,5	42,0	13,0	3,4	13,7	16,0	14,0	9,0	20,0	16,4
120D60502	5/16	5/32	67,5	42,0	13,0	3,4	12,7	16,0	14,0	9,0	20,2	16,4
120D60604	3/8	1/4	82,5	48,0	15,0	3,4	17,2	20,0	16,0	10,5	22,7	20,4
120D60605	3/8	5/16	82,5	48,0	15,0	3,4	17,2	20,0	16,0	10,5	22,7	20,4

Metric dimensions

Manifold

O/D tube to male taper NPTF thread

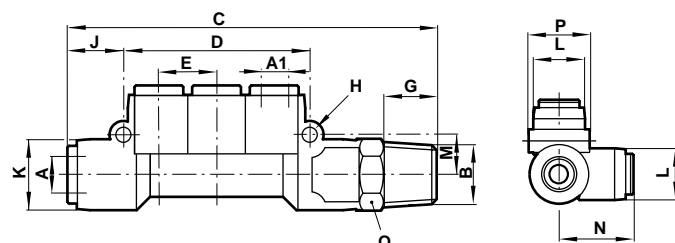

Product number	A O/D tube inlet	A1 O/D tube outlet	B thread	C	D	E	G	H	J	K	L	M	N	P	Q A/F
124D60228	5/16	5/32	1/4	85,5	42,0	13,0	11,1	3,4	12,7	16,0	14,0	9,0	20,2	16,4	11/16
124D60238	5/16	5/32	3/8	86,0	42,0	13,0	12,7	3,4	12,7	16,0	14,0	9,0	20,2	16,4	3/4
124D60428	5/16	1/4	1/4	85,5	42,0	13,0	11,1	3,4	12,7	16,0	14,0	9,0	22,7	16,4	11/16
124D60438	5/16	1/4	3/8	86,5	42,0	13,0	12,7	3,4	12,7	16,0	14,0	9,0	22,7	16,4	3/4
124D60448	3/8	1/4	1/2	103	48,0	15,0	12,7	3,4	17,2	20,0	16,0	10,5	22,7	20,4	7/8
124D60548	3/8	5/16	1/2	107	48,0	15,0	15,9	3,4	17,2	20,0	16,0	10,5	22,7	20,4	7/8

Metric dimensions

Warning

These products are intended for use in industrial compressed air systems only. Do not use these products where pressures and temperatures can exceed those listed under 'Technical Data'.

Before using these products with fluids other than those specified, for non-industrial applications, life-support systems, or other applications not within published specifications, consult Norgren.

Through misuse, age, or malfunction, components used in fluid power systems can fail in various modes. The system designer is warned to consider the failure modes of all component parts used in fluid power systems and to provide adequate safeguards to prevent personal injury or damage to equipment in the event of such failure.

System designers must provide a warning to end users in the system instructional manual if protection against a failure mode cannot be adequately provided.

System designers and end users are cautioned to review specific warnings found in instruction sheets packed and shipped with these products where applicable.

X-ON Electronics

Largest Supplier of Electrical and Electronic Components

Click to view similar products for [norgren](#) manufacturer:

Other Similar products are found below :

[8254200.9151.02400](#) [B72G-2GK-AL3-RMN](#) [C01470828](#) [18-013-989](#) [18-013-990](#) [V61B413A-A213J](#) [100201000](#) [101250828](#) [CS6004010](#)
[F72G-2GN-AL3](#) [101470838](#) [8240400.9101.23050](#) [M/58308/01](#) [RT/57220/M/40](#) [18-015-013](#) [F74G-4GN-AP3](#) [8240400.9101.02400](#)
[C01251048](#) [RT/57212/M/50](#) [M/3314](#) [101250628](#) [101470818](#) [RT/57220/M/80](#) [150050038](#) [602112128](#) [V62C413A-A213J](#) [R07-200-RNKG](#)
[V60A513A-A213J](#) [101250818](#) [10K510618](#) [S/521](#) [101251028](#) [R72G-2GK-RMN](#) [C02260628](#) [C01250838](#) [101470628](#) [C00200400](#) [M/S2](#)
[C01470628](#) [R07-100-RNKG](#) [C01470838](#) [088030000000000000](#) [101250838](#) [101470618](#) [102250628](#) [18-015-989](#) [101470828](#) [C01251038](#) [18-025-003](#) [C01250828](#)