

74ACQ646 • 74ACTQ646

Quiet Series™ Octal Transceiver/Register with 3-STATE Outputs

General Description

The ACQ/ACTQ646 consist of registered bus transceiver circuits, with outputs, D-type flip-flops, and control circuitry providing multiplexed transmission of data directly from the input bus or from the internal storage registers. Data on the A or B bus will be loaded into the respective registers on the LOW-to-HIGH transition of the appropriate clock pin (CPAB or CPBA). The four fundamental handling functions available are illustrated in Figure 1, Figure 2, Figure 3 and Figure 4.

The ACQ/ACTQ utilizes Fairchild Quiet Series™ technology to guarantee quiet output switching and improved dynamic threshold performance. FACT Quiet Series™ features GTO™ output control and undershoot corrector in addition to a split ground bus for superior performance.

Features

- Guaranteed simultaneous switching noise level and dynamic threshold performance
- Guaranteed pin-to-pin skew AC performance
- Independent registers for A and B busses
- Multiplexed real-time and stored data transfers
- 300 mil slim dual-in-line package
- Outputs source/sink 24 mA
- Faster prop delays than the standard AC/ACT646

Ordering Code:

Order Number	Package Number	Package Description
74ACQ646SC	M24B	24-Lead Small Outline Integrated Circuit (SOIC), JEDEC MS-013, 0.300 Wide
74ACQ646ASPC	N24	24-Lead Plastic Dual-In-Line Package (PDIP), JEDEC MS-001, 0.300 Wide
74ACTQ646SC	M24B	24-Lead Small Outline Integrated Circuit (SOIC), JEDEC MS-013, 0.300 Wide
74ACTQ646ASPC	N24	24-Lead Plastic Dual-In-Line Package (PDIP), JEDEC MS-001, 0.300 Wide

Device also available in Tape and Reel. Specify by appending suffix letter "X" to the ordering code.

Connection Diagram

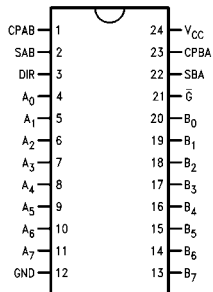

Pin Descriptions

Pin Names	Descriptions
A ₀ –A ₇	Data Register A Inputs
	Data Register A Outputs
B ₀ –B ₇	Data Register B Inputs
	Data Register B Outputs
CPAB, CPBA	Clock Pulse Inputs
SAB, SBA	Transmit/Receive Inputs
\bar{G}	Output Enable Input
DIR	Direction Control Input

FACT™, Quiet Series™, FACT Quiet Series™ and GTO™ are trademarks of Fairchild Semiconductor Corporation

Logic Symbols

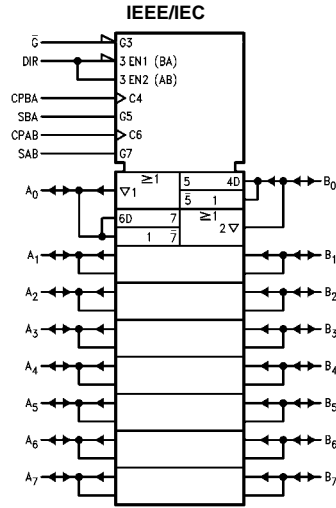
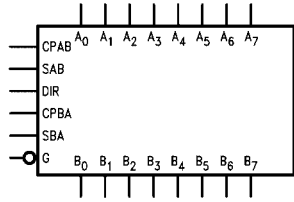

Function Table

Inputs						Data I/O (Note 1)		Function
\overline{G}	DIR	CPAB	CPBA	SAB	SBA	A ₀ -A ₇	B ₀ -B ₇	
H	X	H or L	H or L	X	X	Input	Input	Isolation
H	X	↗	X	X	X			Clock A _n Data into A Register
H	X	X	↗	X	X			Clock B _n Data into B Register
L	H	X	X	L	X	Input	Output	A _n to B _n —Real Time (Transparent Mode)
L	H	↗	X	L	X			Clock A _n Data into A Register
L	H	H or L	X	H	X			A Register to B _n (Stored Mode)
L	H	↗	X	H	X			Clock A _n Data into A Register and Output to B _n
L	L	X	X	X	L	Output	Input	B _n to A _n —Real Time (Transparent Mode)
L	L	X	↗	X	L			Clock B _n Data into B Register
L	L	X	H or L	X	H			B Register to A _n (Stored Mode)
L	L	X	↗	X	H			Clock B _n Data into B Register and Output to A _n

H = HIGH Voltage Level
 L = LOW Voltage Level
 X = Immaterial
 ↗ = LOW-to-HIGH Transition

Note 1: The data output functions may be enabled or disabled by various signals at the \overline{G} and DIR inputs. Data input functions are always enabled; i.e., data at the bus pins will be stored on every LOW-to-HIGH transition of the appropriate clock inputs.

**Real Time Transfer
A-Bus to B-Bus**

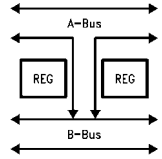

FIGURE 1.

**Real Time Transfer
B-Bus to A-Bus**

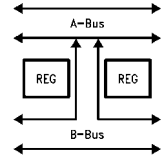

FIGURE 2.

**Storage from
Bus to Register**

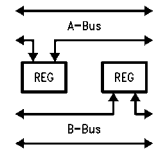

FIGURE 3.

**Transfer from
Register to Bus**

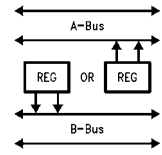
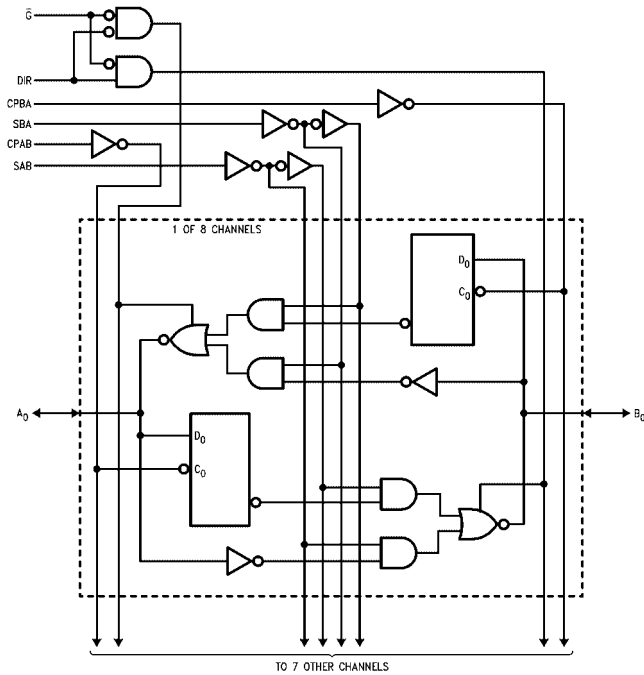

FIGURE 4.

Logic Diagram



Please note that this diagram is provided only for the understanding of logic operations and should not be used to estimate propagation delays.

Absolute Maximum Ratings(Note 2)

Supply Voltage (V_{CC})	-0.5V to +7.0V
DC Input Diode Current (I_{IK})	
$V_I = -0.5V$	-20 mA
$V_I = V_{CC} + 0.5V$	+20 mA
DC Input Voltage (V_I)	-0.5V to $V_{CC} + 0.5V$
DC Output Diode Current (I_{OK})	
$V_O = -0.5V$	-20 mA
$V_O = V_{CC} + 0.5V$	+20 mA
DC Output Voltage (V_O)	-0.5V to $V_{CC} + 0.5V$
DC Output Source	
or Sink Current (I_O)	± 50 mA
DC V_{CC} or Ground Current	
per Output Pin (I_{CC} or I_{GND})	± 50 mA
Storage Temperature (T_{STG})	-65°C to +150°C
DC Latch-Up Source	
or Sink Current	± 300 mA
Junction Temperature (T_J)	
PDIP	140°C

Recommended Operating Conditions

Supply Voltage (V_{CC})	
ACQ	2.0V to 6.0V
ACTQ	4.5V to 5.5V
Input Voltage (V_I)	0V to V_{CC}
Output Voltage (V_O)	0V to V_{CC}
Operating Temperature (T_A)	-40°C to +85°C
Minimum Input Edge Rate $\Delta V/\Delta t$	
ACQ Devices	
V_{IN} from 30% to 70% of V_{CC}	
V_{CC} @ 3.0V, 4.5V, 5.5V	125 mV/ns
Minimum Input Edge Rate $\Delta V/\Delta t$	
ACTQ Devices	
V_{IN} from 0.8V to 2.0V	
V_{CC} @ 4.5V, 5.5V	125 mV/ns

Note 2: Absolute maximum ratings are those values beyond which damage to the device may occur. The databook specifications should be met, without exception, to ensure that the system design is reliable over its power supply, temperature, and output/input loading variables. Fairchild does not recommend operation of FACT™ circuits outside databook specifications.

DC Electrical Characteristics for ACQ

Symbol	Parameter	V_{CC} (V)	$T_A = +25^\circ\text{C}$		$T_A = -40^\circ\text{C to } +85^\circ\text{C}$		Units	Conditions
			Typ	Guaranteed Limits	Typ	Guaranteed Limits		
V_{IH}	Minimum HIGH Level Input Voltage	3.0	1.5	2.1	2.1	V	$V_{OUT} = 0.1V$ or $V_{CC} - 0.1V$	
		4.5	2.25	3.15	3.15			
		5.5	2.75	3.85	3.85			
V_{IL}	Maximum LOW Level Input Voltage	3.0	1.5	0.9	0.9	V	$V_{OUT} = 0.1V$ or $V_{CC} - 0.1V$	
		4.5	2.25	1.35	1.35			
		5.5	2.75	1.65	1.65			
V_{OH}	Minimum HIGH Level Output Voltage	3.0	2.99	2.9	2.9	V	$I_{OUT} = -50 \mu A$	
		4.5	4.49	4.4	4.4			
		5.5	5.49	5.4	5.4			
		3.0		2.56	2.46	V	$V_{IN} = V_{IL}$ or V_{IH} $I_{OH} = -12$ mA $I_{OH} = -24$ mA $I_{OH} = -24$ mA (Note 3)	
		4.5		3.86	3.76			
		5.5		4.85	4.76			
V_{OL}	Maximum LOW Level Output Voltage	3.0	0.002	0.1	0.1	V	$I_{OUT} = 50 \mu A$	
		4.5	0.001	0.1	0.1			
		5.5	0.001	0.1	0.1			
		3.0		0.36	0.44	V	$V_{IN} = V_{IL}$ or V_{IH} $I_{OL} = 12$ mA $I_{OL} = 24$ mA $I_{OL} = 24$ mA (Note 3)	
		4.5		0.36	0.44			
		5.5		0.36	0.44			
I_{IN} (Note 5)	Maximum Input Leakage Current	5.5		± 0.1	± 1.0	μA	$V_I = V_{CC}, GND$	
I_{OLD}	Minimum Dynamic	5.5			75	mA	$V_{OLD} = 1.65V$ Max	
I_{OHD}	Output Current (Note 4)	5.5			-75	mA	$V_{OHD} = 3.85V$ Min	
I_{CC} (Note 5)	Maximum Quiescent Supply Current	5.5		8.0	80.0	μA	$V_{IN} = V_{CC}$ or GND	
I_{OZT}	Maximum I/O Leakage Current (A_n, B_n Inputs)	5.5		± 0.6	± 6.0	μA	$V_I(OE) = V_{IL}, V_{IH}$ $V_I = V_{CC}, GND$ $V_O = V_{CC}, GND$	
V_{OLP}	Quiet Output Maximum Dynamic V_{OL}	5.0	1.1	1.5		V	Figures 5, 6 (Note 6)(Note 7)	

DC Electrical Characteristics for ACQ (Continued)							
Symbol	Parameter	V _{CC} (V)	T _A = +25°C		T _A = -40°C to +85°C	Units	Conditions
			Typ	Guaranteed Limits			
V _{OLV}	Quiet Output Minimum Dynamic V _{OL}	5.0	-0.6	-1.2		V	Figures 5, 6 (Note 6)(Note 7)
V _{IHD}	Minimum HIGH Level Dynamic Input Voltage	5.0	3.1	3.5		V	(Note 6)(Note 8)
V _{ILD}	Maximum LOW Level Dynamic Input Voltage	5.0	1.9	1.5		V	(Note 6)(Note 8)
<p>Note 3: Maximum of 8 outputs loaded; thresholds on input associated with output under test.</p> <p>Note 4: Maximum test duration 2.0 ms, one output loaded at a time.</p> <p>Note 5: I_{IN} and I_{CC} @ 3.0V are guaranteed to be less than or equal to the respective limit @ 5.5V V_{CC}.</p> <p>Note 6: Plastic DIP package.</p> <p>Note 7: Max number of outputs defined as (n). Data inputs are driven 0V to 5V. One output @ GND.</p> <p>Note 8: Max number of Data Inputs (n) switching. (n - 1) inputs switching 0V to 5V (ACQ). Input-under-test switching 5V to threshold (V_{ILD}), 0V to threshold (V_{IHD}) f = 1 MHz.</p>							
DC Electrical Characteristics for ACTQ							
Symbol	Parameter	V _{CC} (V)	T _A = +25°C		T _A = -40°C to +85°C	Units	Conditions
			Typ	Guaranteed Limits			
V _{IH}	Minimum HIGH Level Input Voltage	4.5	1.5	2.0	2.0	V	V _{OUT} = 0.1V or V _{CC} - 0.1V
		5.5	1.5	2.0	2.0		
V _{IL}	Maximum LOW Level Input Voltage	4.5	1.5	0.8	0.8	V	V _{OUT} = 0.1V or V _{CC} - 0.1V
		5.5	1.5	0.8	0.8		
V _{OH}	Minimum HIGH Level Output Voltage	4.5	4.49	4.4	4.4	V	I _{OUT} = -50 μA
		5.5	5.49	5.4	5.4		
		4.5		3.86	3.76		
		5.5		4.86	4.76		I _{OH} = -24 mA (Note 9)
V _{OL}	Maximum LOW Level Output Voltage	4.5	0.001	0.1	0.1	V	I _{OUT} = 50 μA
		5.5	0.001	0.1	0.1		
		4.5		0.36	0.44		
		5.5		0.36	0.44		I _{OL} = 24 mA (Note 9)
I _{IN}	Maximum Input Leakage Current	5.5		±0.1	±1.0	μA	V _i = V _{CC} , GND
I _{OZT}	Maximum I/O Leakage Current (A _n , B _n Inputs)	5.5		±0.6	±6.0	μA	V _i = V _{IL} , V _{IH} V _O = V _{CC} , GND
I _{CC} T	Maximum I _{CC} /Input	5.5	0.6		1.5	mA	V _i = V _{CC} - 2.1V
I _{OLD}	Minimum Dynamic	5.5			75	mA	V _{OLD} = 1.65V Max
I _{OHD}	Output Current (Note 10)	5.5			-75	mA	V _{OHD} = 3.85V Min
I _{CC}	Maximum Quiescent Supply Current	5.5		8.0	80.0	μA	V _{IN} = V _{CC} or GND
V _{OLP}	Quiet Output Maximum Dynamic V _{OL}	5.0	1.1	1.5		V	Figures 5, 6 (Note 11)(Note 12)
V _{OLV}	Quiet Output Minimum Dynamic V _{OL}	5.0	-0.6	-1.2		V	Figures 5, 6 (Note 11)(Note 12)
V _{IHD}	Minimum HIGH Level Dynamic Input Voltage	5.0	1.7	2.0		V	(Note 11)(Note 13)
V _{ILD}	Maximum LOW Level Dynamic Input Voltage	5.0	1.2	0.8		V	(Note 11)(Note 13)
<p>Note 9: All outputs loaded; thresholds on input associated with output under test.</p> <p>Note 10: Maximum test duration 2.0 ms, one output loaded at a time.</p> <p>Note 11: Plastic DIP Package.</p> <p>Note 12: Max number of outputs defined as (n). Data inputs are driven 0V to 3V. One output @ GND.</p> <p>Note 13: Max number of data inputs (n) switching. (n - 1) inputs switching 0V to 3V (ACTQ). Input-under-test switching: 3V to threshold (V_{ILD}), 0V to threshold (V_{IHD}), f = 1 MHz.</p>							

AC Electrical Characteristics for ACQ

Symbol	Parameter	V _{CC} (V) (Note 14)	T _A = +25°C C _L = 50 pF			T _A = -40°C to +85°C C _L = 50 pF		Units
			Min	Typ	Max	Min	Max	
t _{PLH}	Propagation Delay	3.3	3.5	9.0	12.0	3.5	13.0	ns
	Bus to Bus	5.0	2.5	6.5	9.0	2.5	9.5	
t _{PHL}	Propagation Delay	3.3	3.5	9.0	12.0	3.5	13.0	ns
	Bus to Bus	5.0	2.5	6.5	9.0	2.5	9.5	
t _{PLH}	Propagation Delay	3.3	3.5	10.0	13.0	3.5	14.0	ns
	Clock to Bus	5.0	2.5	7.0	9.5	2.5	10.5	
t _{PHL}	Propagation Delay	3.3	3.5	10.0	13.0	3.5	14.0	ns
	Clock to Bus	5.0	2.5	7.0	9.5	2.5	10.5	
t _{PLH}	Propagation Delay	3.3	3.5	9.5	12.5	3.5	13.5	ns
	SBA or SAB to A _n or B _n (w/A _n or B _n HIGH or LOW)	5.0	2.5	6.5	9.0	2.5	10.0	
t _{PHL}	Propagation Delay	3.3	3.5	9.5	12.5	3.5	13.5	ns
	SBA or SAB to A _n or B _n (w/A _n or B _n HIGH or LOW)	5.0	2.5	6.5	9.0	2.5	10.0	
t _{PZH}	Enable Time	3.3	3.5	10.5	14.5	3.5	15.5	ns
	\overline{G} to A _n or B _n	5.0	2.5	8.0	10.5	2.5	11.5	
t _{PZL}	Enable Time	3.3	3.5	10.5	14.5	3.5	15.5	ns
	\overline{G} to A _n or B _n	5.0	2.5	8.0	10.5	2.5	11.5	
t _{PHZ}	Disable Time	3.3	2.5	8.0	11.0	2.5	12.0	ns
	\overline{G} to A _n or B _n	5.0	1.5	5.0	7.5	1.5	8.0	
t _{PLZ}	Disable Time	3.3	2.5	8.0	11.0	2.5	12.0	ns
	\overline{G} to A _n or B _n	5.0	1.5	5.0	7.5	1.5	8.0	
t _{PZH}	Enable Time	3.3	4.5	11.0	15.5	4.5	17.0	ns
	DIR to A _n or B _n	5.0	3.0	8.5	11.0	3.0	11.5	
t _{PZL}	Enable Time	3.3	4.5	11.0	15.5	4.5	17.0	ns
	DIR to A _n or B _n	5.0	3.0	8.5	11.0	3.0	11.5	
t _{PHZ}	Disable Time	3.3	1.5	8.0	11.0	1.5	12.0	ns
	DIR to A _n or B _n	5.0	1.0	5.0	7.5	1.0	8.0	
t _{PLZ}	Disable Time	3.3	1.5	8.0	11.0	1.5	12.0	ns
	DIR to A _n or B _n	5.0	1.0	5.0	7.5	1.0	8.0	
t _{OS}	Output to Output Skew (Note 15)	3.3		1.0	1.5		1.5	ns
		5.0		0.5	1.0		1.0	

Note 14: Voltage Range 3.3 is 3.3V ± 0.3V.
Voltage Range 5.0 is 5.0V ± 0.5V

Note 15: Skew is defined as the absolute value of the difference between the actual propagation delay for any two outputs within the same packaged device. The specification applies to any outputs switching in the same direction, either HIGH-to-LOW (t_{OSHL}) or LOW-to-HIGH (t_{OSLH}). Parameter guaranteed by design. Not tested.

AC Operating Requirements for ACQ

Symbol	Parameter	V _{CC} (Note 16)	T _A = +25°C	T _A = -40°C to +85°C		Units
			Typ	Guaranteed Minimum		
t _S	Setup Time, HIGH or LOW	3.3		3.0	3.0	ns
	Bus to Clock	5.0		3.0	3.0	
t _H	Hold Time, HIGH or LOW	3.3		1.5	1.5	ns
	Bus to Clock	5.0		1.5	1.5	
t _W	Clock Pulse Width	3.3		4.0	4.0	ns
	HIGH or LOW	5.0		4.0	4.0	

Note 16: Voltage Range 5.0 is 5.0V ± 0.5V
Voltage Range 3.3 is 3.3V ± 0.3V

AC Electrical Characteristics for ACTQ								
Symbol	Parameter	V _{CC} (V) (Note 17)	T _A = +25°C C _L = 50 pF			T _A = -40°C to +85°C C _L = 50 pF		Units
			Min	Typ	Max	Min	Max	
t _{PLH} t _{PHL}	Propagation Delay Clock to Bus	5.0	2.5	8.5	10.5	2.5	11.0	ns
t _{PLH} t _{PHL}	Propagation Delay Bus to Bus	5.0	2.0	8.0	10.0	2.0	10.5	ns
t _{PLH} t _{PHL}	Propagation Delay SBA or SAB to A _n or B _n (w/A _n or B _n HIGH or LOW)	5.0	2.5	8.5	10.5	2.5	11.0	ns
t _{PZH} t _{PZL}	Enable Time G̅ to A _n or B _n	5.0	2.5	10.0	12.0	2.5	12.5	ns
t _{PHZ} t _{PLZ}	Disable Time G̅ to A _n or B _n	5.0	1.0	7.0	8.5	1.0	9.0	ns
t _{PZH} t _{PZL}	Enable Time DIR to A _n or B _n	5.0	2.5	10.0	12.0	2.5	12.5	ns
t _{PHZ} t _{PLZ}	Disable Time DIR to A _n or B _n	5.0	1.0	7.0	8.5	1.0	9.0	ns
t _{OSSL} t _{OSLH}	Output to Output Skew (Note 18) Select to Bus or Clock to Bus	5.0		0.5	1.0		1.0	ns
t _{OSSL} t _{OSLH}	Output to Output Skew (Note 18) Bus to Bus	5.0		1.0	1.5		1.5	ns
<p>Note 17: Voltage Range 5.0 is 5.0V ± 0.5V</p> <p>Note 18: Skew is defined as the absolute value of the difference between the actual propagation delay for any two outputs within the same packaged device. The specification applies to any outputs switching in the same direction, either HIGH-to-LOW (t_{OSSL}) or LOW-to-HIGH (t_{OSLH}). Parameter guaranteed by design. Not tested.</p>								
AC Operating Requirements for ACTQ								
Symbol	Parameter	V _{CC} (V) (Note 19)	T _A = +25°C C _L = 50 pF		T _A = -40°C to +85°C C _L = 50 pF		Units	
			Typ	Guaranteed Minimum	Guaranteed Minimum			
t _S	Setup Time, HIGH or LOW Bus to Clock	5.0		3.0	3.0		ns	
t _H	Hold Time, HIGH or LOW Bus to Clock	5.0		1.5	1.5		ns	
t _W	Clock Pulse Width HIGH or LOW	5.0		4.0	4.0		ns	
<p>Note 19: Voltage Range 5.0 is 5.0V ± 0.5V</p>								
Capacitance								
Symbol	Parameter	Typ	Units	Conditions				
C _{IN}	Input Capacitance	4.5	pF	V _{CC} = OPEN				
C _{I/O}	Input/Output Capacitance	15.0	pF	V _{CC} = 5.0V				
C _{PD}	Power Dissipation Capacitance	90.0	pF	V _{CC} = 5.0V				

FACT Noise Characteristics

The setup of a noise characteristics measurement is critical to the accuracy and repeatability of the tests. The following is a brief description of the setup used to measure the noise characteristics of FACT.

Equipment:

Hewlett Packard Model 8180A Word Generator
PC-163A Test Fixture
Tektronics Model 7854 Oscilloscope

Procedure:

1. Verify Test Fixture Loading: Standard Load 50 pF, 500Ω.
2. Deskew the HFS generator so that no two channels have greater than 150 ps skew between them. This requires that the oscilloscope be deskewed first. It is important to deskew the HFS generator channels before testing. This will ensure that the outputs switch simultaneously.
3. Terminate all inputs and outputs to ensure proper loading of the outputs and that the input levels are at the correct voltage.
4. Set the HFS generator to toggle all but one output at a frequency of 1 MHz. Greater frequencies will increase DUT heating and effect the results of the measurement.
5. Set the HFS generator input levels at 0V LOW and 3V HIGH for ACT devices and 0V LOW and 5V HIGH for AC devices. Verify levels with an oscilloscope.

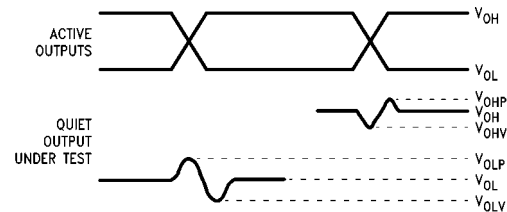

FIGURE 5. Quiet Output Noise Voltage Waveforms

Note 20: V_{OHV} and V_{OLP} are measured with respect to ground reference.

Note 21: Input pulses have the following characteristics: $f = 1$ MHz, $t_r = 3$ ns, $t_f = 3$ ns, skew < 150 ps.

V_{OLP}/V_{OLV} and V_{OHP}/V_{OHV} :

- Determine the quiet output pin that demonstrates the greatest noise levels. The worst case pin will usually be the furthest from the ground pin. Monitor the output voltages using a 50Ω coaxial cable plugged into a standard SMB type connector on the test fixture. Do not use an active FET probe.
- Measure V_{OLP} and V_{OLV} on the quiet output during the worst case transition for active and enable. Measure V_{OHP} and V_{OHV} on the quiet output during the worst case active and enable transition.
- Verify that the GND reference recorded on the oscilloscope has not drifted to ensure the accuracy and repeatability of the measurements.

V_{ILD} and V_{IHD} :

- Monitor one of the switching outputs using a 50Ω coaxial cable plugged into a standard SMB type connector on the test fixture. Do not use an active FET probe.
- First increase the input LOW voltage level, V_{IL} , until the output begins to oscillate or steps out a min of 2 ns. Oscillation is defined as noise on the output LOW level that exceeds V_{IL} limits, or on output HIGH levels that exceed V_{IH} limits. The input LOW voltage level at which oscillation occurs is defined as V_{ILD} .
- Next decrease the input HIGH voltage level, V_{IH} , until the output begins to oscillate or steps out a min of 2 ns. Oscillation is defined as noise on the output LOW level that exceeds V_{IL} limits, or on output HIGH levels that exceed V_{IH} limits. The input HIGH voltage level at which oscillation occurs is defined as V_{IHD} .
- Verify that the GND reference recorded on the oscilloscope has not drifted to ensure the accuracy and repeatability of the measurements.

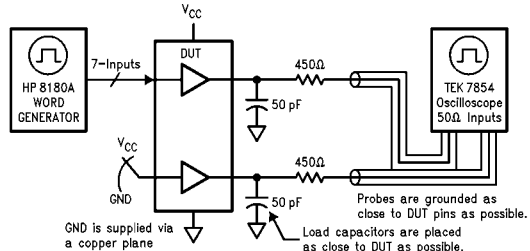
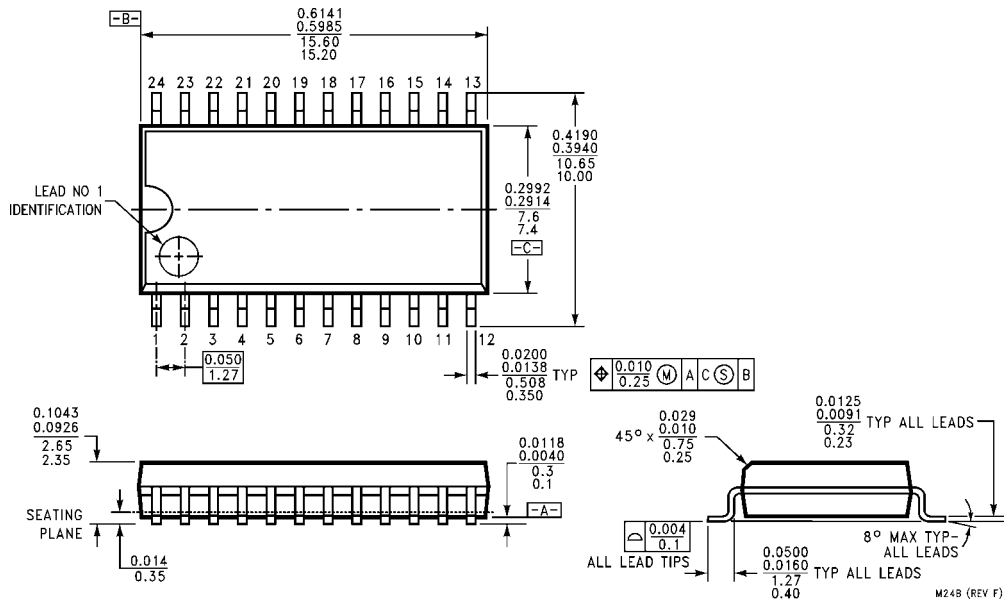
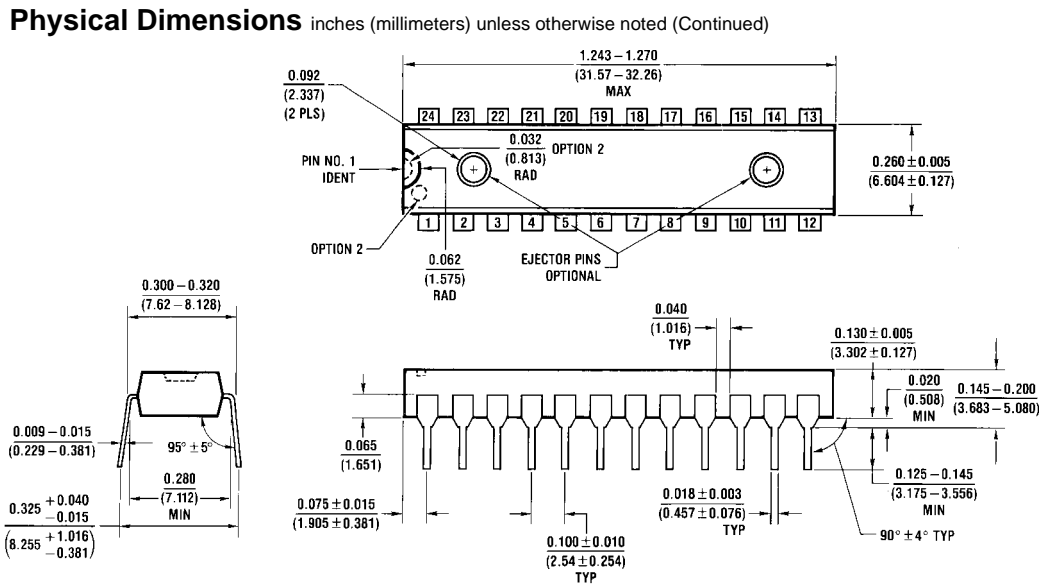

FIGURE 6. Simultaneous Switching Test Circuit

Physical Dimensions inches (millimeters) unless otherwise noted



**24-Lead Small Outline Integrated Circuit (SOIC), JEDEC MS-013, 0.300 Wide
Package Number M24B**



24-Lead Plastic Dual-In-Line Package (PDIP), JEDEC MS-001, 0.300 Wide Package Number N24C

N24C (REV F)

Fairchild does not assume any responsibility for use of any circuitry described, no circuit patent licenses are implied and Fairchild reserves the right at any time without notice to change said circuitry and specifications.

LIFE SUPPORT POLICY

FAIRCHILD'S PRODUCTS ARE NOT AUTHORIZED FOR USE AS CRITICAL COMPONENTS IN LIFE SUPPORT DEVICES OR SYSTEMS WITHOUT THE EXPRESS WRITTEN APPROVAL OF THE PRESIDENT OF FAIRCHILD SEMICONDUCTOR CORPORATION. As used herein:





1. Life support devices or systems are devices or systems which, (a) are intended for surgical implant into the body, or (b) support or sustain life, and (c) whose failure to perform when properly used in accordance with instructions for use provided in the labeling, can be reasonably expected to result in a significant injury to the user.
2. A critical component in any component of a life support device or system whose failure to perform can be reasonably expected to cause the failure of the life support device or system, or to affect its safety or effectiveness.

www.fairchildsemi.com



TRADEMARKS

The following includes registered and unregistered trademarks and service marks, owned by Fairchild Semiconductor and/or its global subsidiaries, and is not intended to be an exhaustive list of all such trademarks.

AccuPower™	FRFET®	PowerTrench®	The Power Franchise®
Auto-SPM™	Global Power Resource™	PowerXS™	the power franchise
Build it Now™	Green FPS™	Programmable Active Droop™	TinyBoost™
CorePLUS™	Green FPS™ e-Series™	QFET®	TinyBuck™
CorePOWER™	Gmax™	QS™	TinyCalc™
CROSSVOLT™	GTO™	Quiet Series™	TinyLogic®
CTL™	IntelliMAX™	RapidConfigure™	TINYOPTO™
Current Transfer Logic™	ISOPLANAR™	 ™	TinyPower™
DEUXPEED®	MegaBuck™	Saving our world, 1mW/W/kW at a time™	TinyPWM™
Dual Cool™	MICROCOUPLER™	SignalWise™	TinyWire™
EcoSPARK®	MicroFET™	SmartMax™	TriFault Detect™
EfficientMax™	MicroPak™	SMART START™	TRUECURRENT™*
 ™	MicroPak2™	SPM®	µSerDes™
Fairchild®	MillerDrive™	STEALTH™	 ™
Fairchild Semiconductor®	MotionMax™	SuperFET™	UHC®
FACT Quiet Series™	Motion-SPM™	SuperSOT™-3	Ultra FRFET™
FACT®	OptoHiT™	SuperSOT™-6	UniFET™
FAST®	OPTOLOGIC®	SuperSOT™-8	VCX™
FastvCore™	OPTOPLANAR®	SupreMOS™	VisualMax™
FETBench™	 ™	SyncFET™	XS™
FlashWriter®*	PDP SPM™	Sync-Lock™	
FPS™	Power-SPM™	 ™*	
F-PFS™			

* Trademarks of System General Corporation, used under license by Fairchild Semiconductor.

DISCLAIMER

FAIRCHILD SEMICONDUCTOR RESERVES THE RIGHT TO MAKE CHANGES WITHOUT FURTHER NOTICE TO ANY PRODUCTS HEREIN TO IMPROVE RELIABILITY, FUNCTION, OR DESIGN. FAIRCHILD DOES NOT ASSUME ANY LIABILITY ARISING OUT OF THE APPLICATION OR USE OF ANY PRODUCT OR CIRCUIT DESCRIBED HEREIN; NEITHER DOES IT CONVEY ANY LICENSE UNDER ITS PATENT RIGHTS, NOR THE RIGHTS OF OTHERS. THESE SPECIFICATIONS DO NOT EXPAND THE TERMS OF FAIRCHILD'S WORLDWIDE TERMS AND CONDITIONS, SPECIFICALLY THE WARRANTY THEREIN, WHICH COVERS THESE PRODUCTS.

LIFE SUPPORT POLICY

FAIRCHILD'S PRODUCTS ARE NOT AUTHORIZED FOR USE AS CRITICAL COMPONENTS IN LIFE SUPPORT DEVICES OR SYSTEMS WITHOUT THE EXPRESS WRITTEN APPROVAL OF FAIRCHILD SEMICONDUCTOR CORPORATION.

As used herein:

1. Life support devices or systems are devices or systems which, (a) are intended for surgical implant into the body or (b) support or sustain life, and (c) whose failure to perform when properly used in accordance with instructions for use provided in the labeling, can be reasonably expected to result in a significant injury of the user.
2. A critical component in any component of a life support, device, or system whose failure to perform can be reasonably expected to cause the failure of the life support device or system, or to affect its safety or effectiveness.

ANTI-COUNTERFEITING POLICY

Fairchild Semiconductor Corporation's Anti-Counterfeiting Policy. Fairchild's Anti-Counterfeiting Policy is also stated on our external website, www.fairchildsemi.com, under Sales Support.

Counterfeiting of semiconductor parts is a growing problem in the industry. All manufacturers of semiconductor products are experiencing counterfeiting of their parts. Customers who inadvertently purchase counterfeit parts experience many problems such as loss of brand reputation, substandard performance, failed applications, and increased cost of production and manufacturing delays. Fairchild is taking strong measures to protect ourselves and our customers from the proliferation of counterfeit parts. Fairchild strongly encourages customers to purchase Fairchild parts either directly from Fairchild or from Authorized Fairchild Distributors who are listed by country on our web page cited above. Products customers buy either from Fairchild directly or from Authorized Fairchild Distributors are genuine parts, have full traceability, meet Fairchild's quality standards for handling and storage and provide access to Fairchild's full range of up-to-date technical and product information. Fairchild and our Authorized Distributors will stand behind all warranties and will appropriately address any warranty issues that may arise. Fairchild will not provide any warranty coverage or other assistance for parts bought from Unauthorized Sources. Fairchild is committed to combat this global problem and encourage our customers to do their part in stopping this practice by buying direct or from authorized distributors.

PRODUCT STATUS DEFINITIONS

Definition of Terms

Datasheet Identification	Product Status	Definition
Advance Information	Formative / In Design	Datasheet contains the design specifications for product development. Specifications may change in any manner without notice.
Preliminary	First Production	Datasheet contains preliminary data; supplementary data will be published at a later date. Fairchild Semiconductor reserves the right to make changes at any time without notice to improve design.
No Identification Needed	Full Production	Datasheet contains final specifications. Fairchild Semiconductor reserves the right to make changes at any time without notice to improve the design.
Obsolete	Not In Production	Datasheet contains specifications on a product that is discontinued by Fairchild Semiconductor. The datasheet is for reference information only.

X-ON Electronics

Largest Supplier of Electrical and Electronic Components

Click to view similar products for [Bus Transceivers](#) category:

Click to view products by [ON Semiconductor](#) manufacturer:

Other Similar products are found below :

[74LS645N](#) [DS8838](#) [FXL4TD245UMX](#) [IDT74CBTLV3257PGG](#) [74LVT245BBT20-13](#) [5962-8683401DA](#) [PCA9617ADMR2G](#) [5962-8953501KA](#) [5962-86834012A](#) [5962-7802301Q2A](#) [5962-7802002MFA](#) [5962-7802001MFA](#) [74VHCV245FT\(BJ\)](#) [NCV7349D13R2G](#) [TC74VCX164245\(EL,F](#) [MC74LCX245MNTWG](#) [TC7WPB8306L8X,LF\(S](#) [TC7WPB9307FC\(TE85L](#) [74FCT16245CTPVG8](#) [74FCT16543CTPVG](#) [74FCT245CTPYG8](#) [MM74HC245AMTCX](#) [74LVCH16245APVG](#) [74LVX245MTC](#) [5962-9221405M2A](#) [NTS0102DP-Q100H](#) [74ALVC16245MTDX](#) [74ALVCH32245BF](#) [74FCT163245APVG](#) [74FCT245ATPYG8](#) [74FCT245CTQG](#) [74FCT3245AQG](#) [74LCXR162245MTX](#) [74VHC245M](#) [74VHC245MX](#) [TC7WPB9306FC\(TE85L](#) [TC7WPB9306FK\(T5L,F](#) [JM38510/65553BRA](#) [ST3384EBDR](#) [74LVC1T45GF,132](#) [74AVC4TD245BQ,115](#) [PQJ7980AHN/C0JL,51](#) [MC100EP16VBDG](#) [FXL2TD245L10X](#) [74LVC1T45GM,115](#) [TC74AC245P\(F\)](#) [PSB21150F S LLHR](#) [SNJ54LS245FK](#) [SNJ54AHC245J](#) [SNJ54ABT245AFK](#)