

<b>Specification</b>				
<b>Part Number:</b>				
<b>Version:</b>				
<b>Date:</b>				
<b>Revision</b>				
<b>No.</b>	<b>Date</b>	<b>Description</b>	<b>Item</b>	<b>Page</b>

# Content

- Coding system .....3
- Functions and Features.....4
- Mechanical Specification.....4
- Mechanical Drawing.....5
- Pin Description .....6
- Block Diagram.....8
- DC Characteristics .....10
- Optical Characteristics .....10
- Absolute Maximum rating.....11
- AC Characteristics.....11
- Actual Application Example.....12

MIDAS

design • manufacture • supply

# Midas Displays OLED Part Number System

<b>MCO</b>	<b>B</b>	<b>21605</b>	<b>A</b>	<b>*</b>	<b>V</b>	<b>-</b>	<b>E</b>	<b>W</b>	<b>I</b>	<b>*</b>
<b>1</b>	<b>2</b>	<b>3</b>	<b>4</b>	<b>5</b>	<b>6</b>		<b>7</b>	<b>8</b>	<b>9</b>	<b>10</b>
1	=	<b>MCO:</b>	Midas Displays OLED							
2	=	<b>Blank:</b>	<b>B:</b> COB (Chip on Board) <b>T:</b> TAB (Taped Automated Bonding)							
3	=	<b>No of dots:</b>	(e.g. 240064 = 240 x 64 dots)				(e.g. 21605 = 2 x 16 5mm C.H.)			
4	=	<b>Series</b>	A to Z							
5	=	<b>Series Variant:</b>	A to Z and 1 to 9 – see addendum							
6	=	<b>Operating Temp Range:</b>	<b>A:</b> -30+85° C		<b>V:</b> -40+80° C		<b>Y:</b> -40 +70° C		<b>Z:</b> -30+70° C	
			<b>X:</b> -40 +85° C							
7	=	<b>Character Set:</b>	<b>Blank:</b> Not Applicable <b>E:</b> Multi European Font Set (English/Japanese – Western European (K) – Cyrillic (R))							
8	=	<b>Colour:</b>	<b>Y:</b> Yellow		<b>W:</b> White		<b>B:</b> Blue		<b>R:</b> Red	
							<b>G:</b> Green		<b>RGB:</b> Full Colour	
9	=	<b>Interface:</b>	<b>P:</b> Parallel		<b>I:</b> I <sup>2</sup> C		<b>S:</b> SPI		<b>M:</b> Multi	
10	=	<b>Voltage Variant:</b>	e.g. <b>3</b> = 3v							

## Functions and Features

- 96X16 Graphic
- Built-in controller
- viewing angle Free
- Wide Temperature -40°C ~ +80°C (Operating)
- RoHS compliant

## Mechanical Specification

Item	Description	
Inch	0.84"	
Color	White	
Active Area	21.104(W)×3.504(H)	mm
Panel Size	29.10(W)×9.20(H)×1.30 (D)mm	mm
Dot Size	0.204(W)×0.204(H)	mm
Dot Pitch	0.22(W)×0.22(H)	mm
Display Format	96 × 16	
Duty Ratio	1/16 Duty	Duty
Controller	SSD1306 or Equivalent	
Operation Temperature	-40~80	°C
Storage Temperature	-40~85	°C
Response Time	≤10	us
Assembly	Soldering	

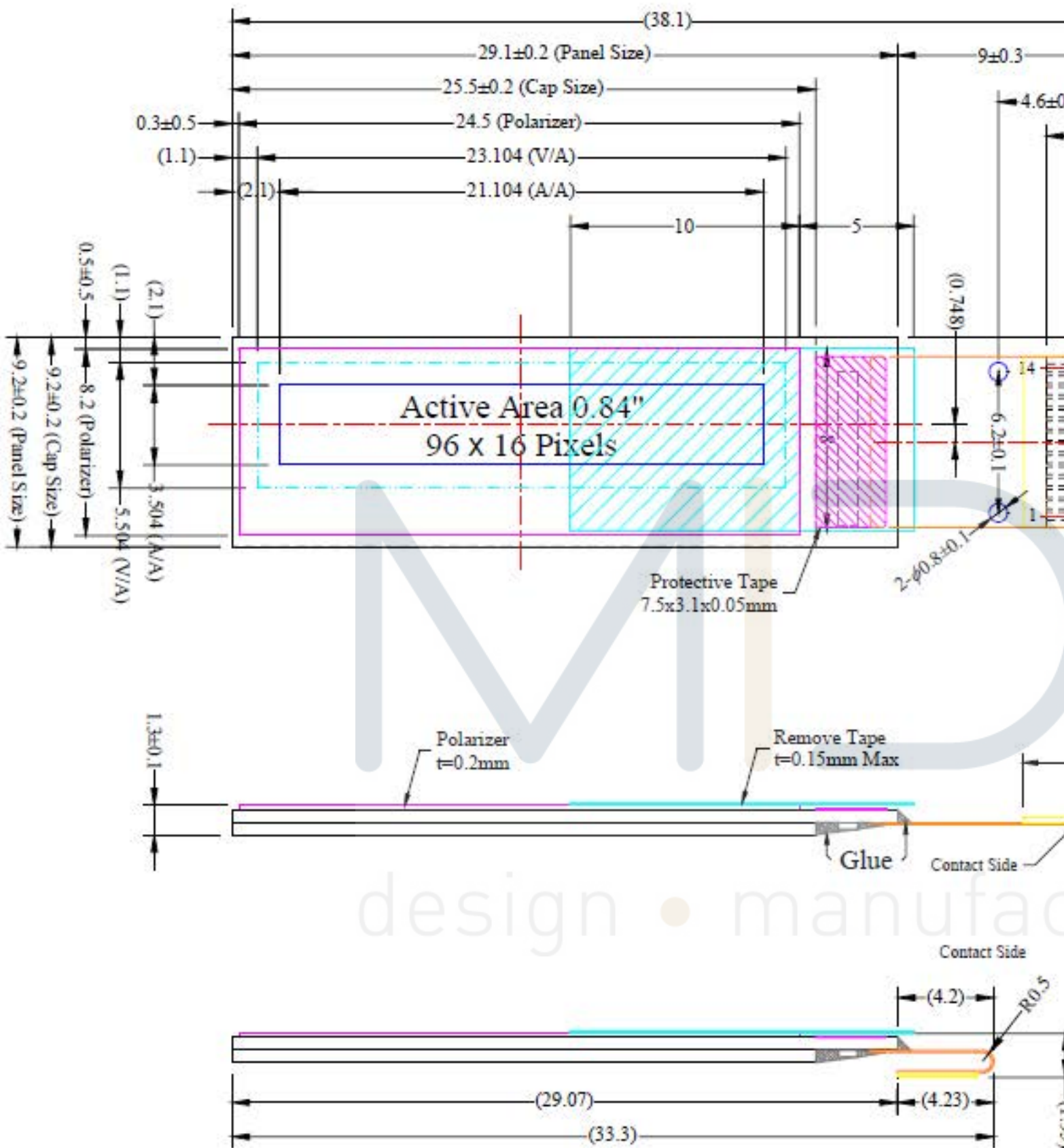

(Reference Mechanical Design)

# Pin Description

## Power Supply

Pin Number	Symbol	Type	Function
8	VDD	P	<b>Power Supply for Logic Circuit</b> This is a voltage supply pin. It must be connected to external source.
7	VSS		<b>Ground of OEL System</b> This is a ground pin. It also acts as a reference for the logic pins. It must be connected to external ground.
14	VCC		<b>Power Supply for OEL Panel</b> This is the most positive voltage supply pin of the chip. It must be supplied externally.

## Driver

Pin Number	Symbol	Type	Function
12	IREF	I	<b>Current reference for Brightness Adjustment</b> This pin is segment current reference pin. A resistor should be connected between this pin and VSS. Set the current at 10 $\mu$ A maximum.
13	VCOMH	O	<b>Voltage Output High Level for COM Signal</b> This pin is the input pin for the voltage output high level for COM signals. A tantalum capacitor should be connected between this pin and VSS.

## DC/DC Converter

Pin Number	Symbol	Type	Function
5	VDDB	P	<b>Power Supply for DC/DC Converter Circuit</b> This is the power supply pin for the internal buffer of the DC/DC voltage converter. It must be connected to external source when the converter is used. It should be connected to VDD when the converter is not used.
3/4 1/2	C1P/C1N C2P/C2N	I	<b>Positive Terminal of the Flying Inverting Capacitor</b> <b>Negative Terminal of the Flying Boost Capacitor</b> <b>The charge-pump capacitors are required between the terminals.</b> <b>They must be floated when the converter is not used.</b>

### Interface

Pin Number	Symbol	Type	Function
9	RES#	I	<b>Power Reset for Controller and Driver</b> This pin is reset signal input. When the pin is low, initialization of the chip is executed. Keep this pin pull high during normal operation.
10	SCL		<b>I2C Bus Clock Signal</b> The transmission of information in the I2C bus is following a clock signal. Each transmission of data bit is taken place during a single clock period of this pin.
11	SDA	I/O	<b>I2C Bus Data Signal</b> This pin acts as a communication channel between the transmitter and the receiver.

### Reserve

Pin Number	Symbol	Type	Function
6	N.C.	-	<b>Reserved Pin</b> The N.C. pin between function pins is reserved for compatible and flexible design. It must be floated.

## Block Diagram

VCC Supplied Externally

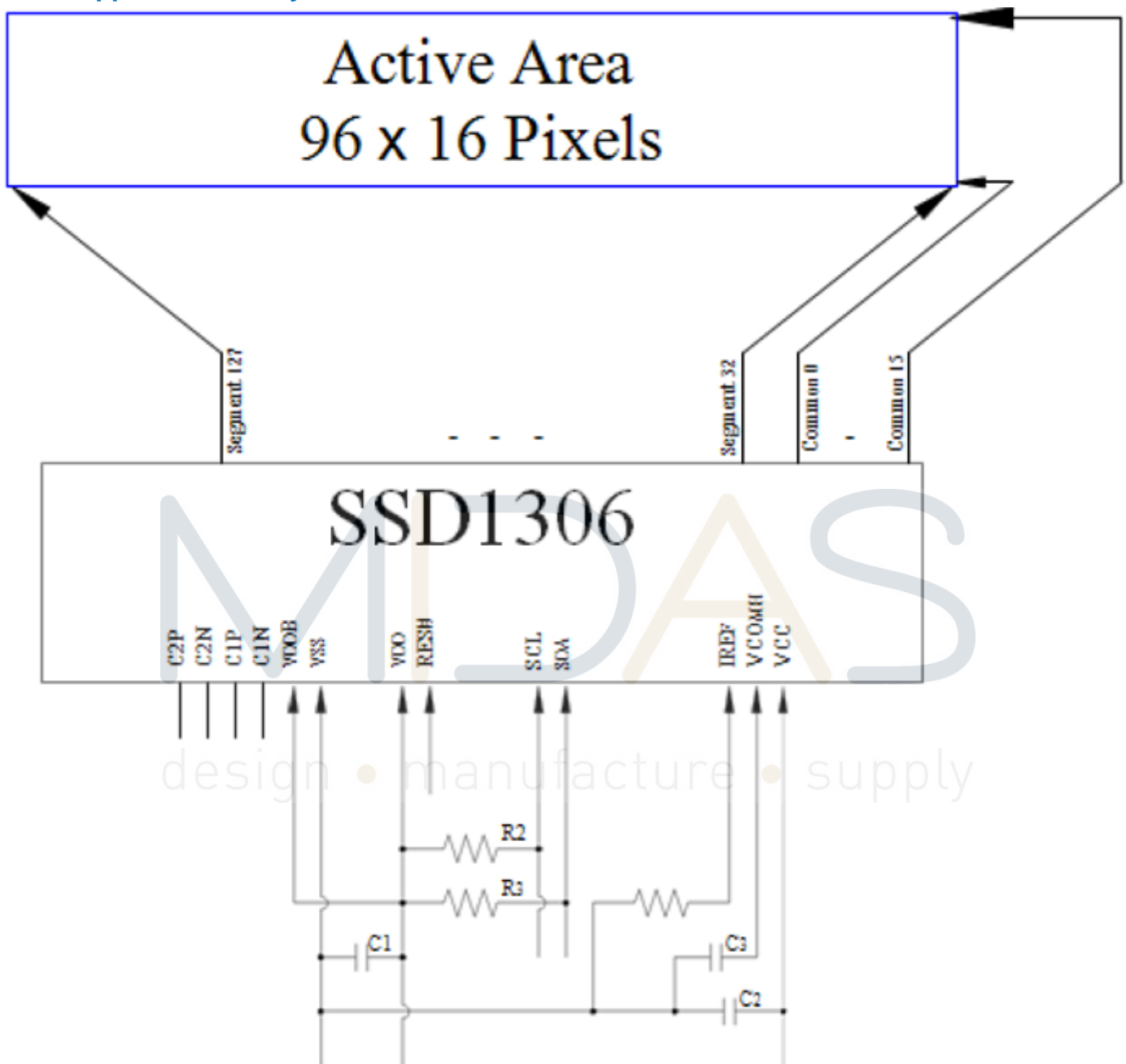

Pins connected to MCU interface: RES#, SCL, and SDA

C1: 1 $\mu$ F

C2: 4.7 $\mu$ F

C3: 4.7 $\mu$ F / 16V X7R

R1: 820k $\Omega$ , R1 = (Voltage at IREF - VSS) / IREF

R2, R3: 2k



## VCC Generated by Internal DC/DC Circuit

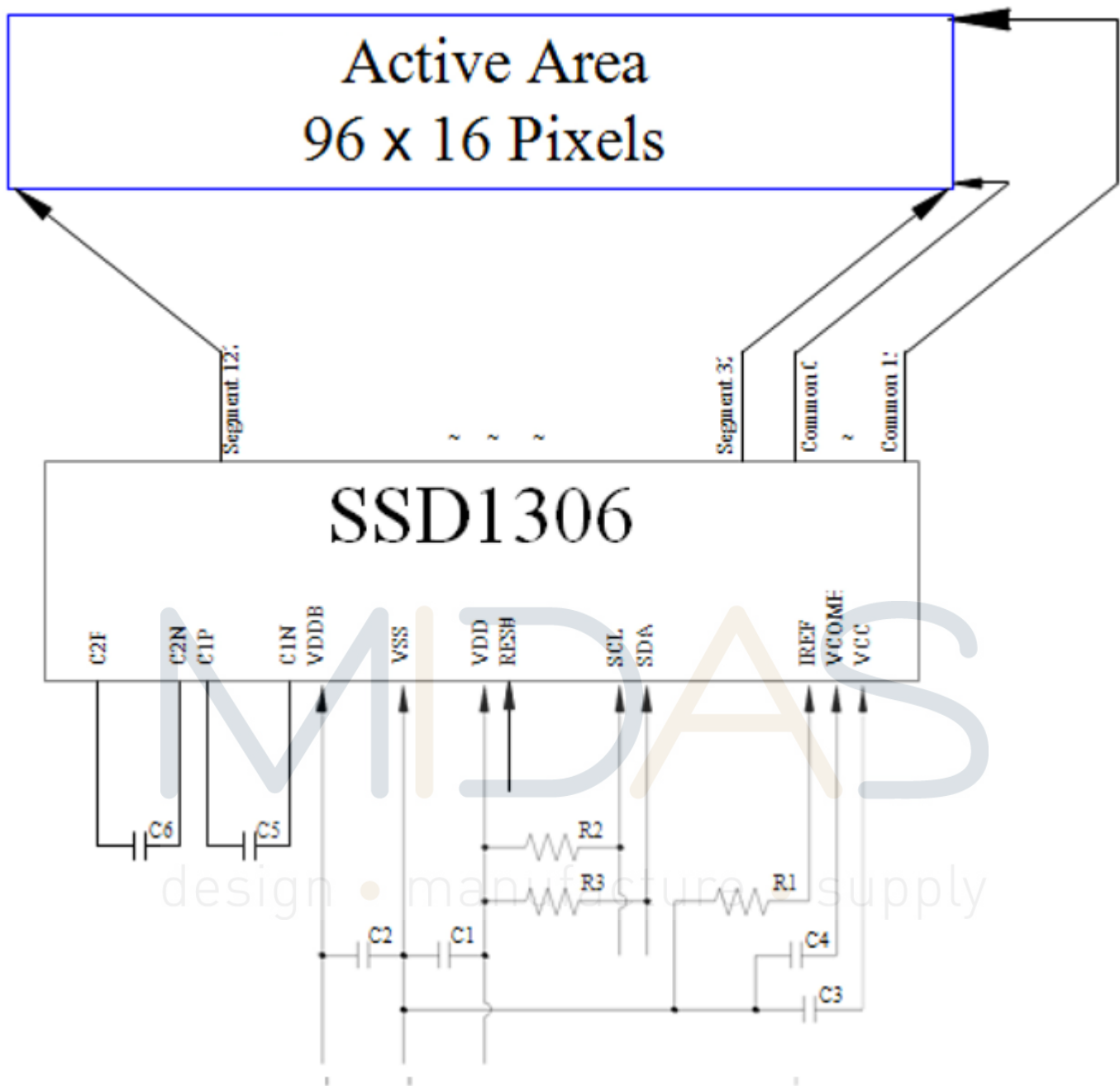

Pins connected to MCU interface: RES#, SCL, and SDA

C1, C2: 1 $\mu$ F

C3: 2.2 $\mu$ F

C4: 4.7 $\mu$ F / 16V X7R

C5, C6: 1 $\mu$ F / 16V X5R

R1: 820k $\Omega$ , R1 = (Voltage at IREF - VSS) / IREF

R2, R3: 2k

## DC Characteristics

Item	Symbol	Condition	Min.	Type	Max.	Unit
Supply Voltage for Logic	VCI		1.65	2.8	3.3	Volt
Supply Voltage for Display (Supplied Externally)	VCC	Note 4 (Internal DC/DC Disable)	7.0	7.25	7.5	Volt
Supply Voltage for DC/DC	VDDDB	Internal DC/DC Enable	3.3	-	4.2	Volt
Supply Voltage for Display (Generated by Internal DC/DC)	VCC	Note 4 (Internal DC/DC Disable)	7.0	-	7.5	Volt
Operating Current for VDD	I <sub>DD</sub>		-	180	300	μA
Operating Current for VCC (VCC Supplied Externally)	I <sub>CC</sub>	Note 5	-	2.0	3.0	mA
		Note 6	-	2.5	3.8	mA
		Note 7	-	5.0	7.5	mA
Operating Current for VCC (VCC Generated by Internal DC/DC)	I <sub>DDDB</sub>	Note 5	-	3.5	5.3	mA
		Note 6	-	4.0	6.0	mA
		Note 7	-	4.5	6.8	mA
Sleep Mode Current for VDD	I <sub>DD,SLEEP</sub>			1	5	μA
Sleep Mode Current for VCC	I <sub>CC,SLEEP</sub>		-	2	10	μA

Note 4: Brightness (Lbr) and Supply Voltage for Display (VCC) are subject to the change of the panel characteristics and the customer's request.

Note 5: VDD = 2.8V, VCC = 7.25V, 30% Display Area Turn on.

Note 6: VDD = 2.8V, VCC = 7.25V, 50% Display Area Turn on.

Note 7: VDD = 2.8V, VCC = 7.25V, 100% Display Area Turn on.

## Optical Characteristics

Item	Symbol	Conditions	Min.	Typ	Max.	Unit
Brightness(White)	Lbr	Note 4	120	150	-	cd/m <sup>2</sup>
C.I.E. (White)	(X)	C.I.E 1931	0.25	0.29	0.33	
	(Y)		0.27	0.31	0.35	
Dark Room Contrast	CR	-	-	>10000:1	-	
Viewing angle range	-	-	-	Free	-	Degree

\* Optical measurement taken at VDD = 2.8V, VCC = 7.25V.

## Absolute Maximum rating

Item	Symbol	Min.	Typ.	Max.	Unit	Notes
Supply Voltage for Logic	VDD	-0.3	-	4	Volt	1,2
Supply Voltage for Display	Vcc	0	-	11	Volt	1,2
Life Time (80 cd/m <sup>2</sup> )		---	40,000	---	Hour	3

Note 1: All the above voltages are on the basis of "VSS = 0V".

Note 2: When this module is used beyond the above absolute maximum ratings, permanent breakage of the module may occur. Also, for normal operations, it is desirable to use this module under the conditions according to Section 3. "Optics". If this module is used beyond these conditions, malfunctioning of the module can occur and the reliability of the module may deteriorate.

Note 3: VCC = 7.25V, Ta = 25°C, 50% Checkerboard.

## AC Characteristics

please refer "SSD1306 specification.



# Actual Application Example

Command usage and explanation of an actual example

< Initialization >

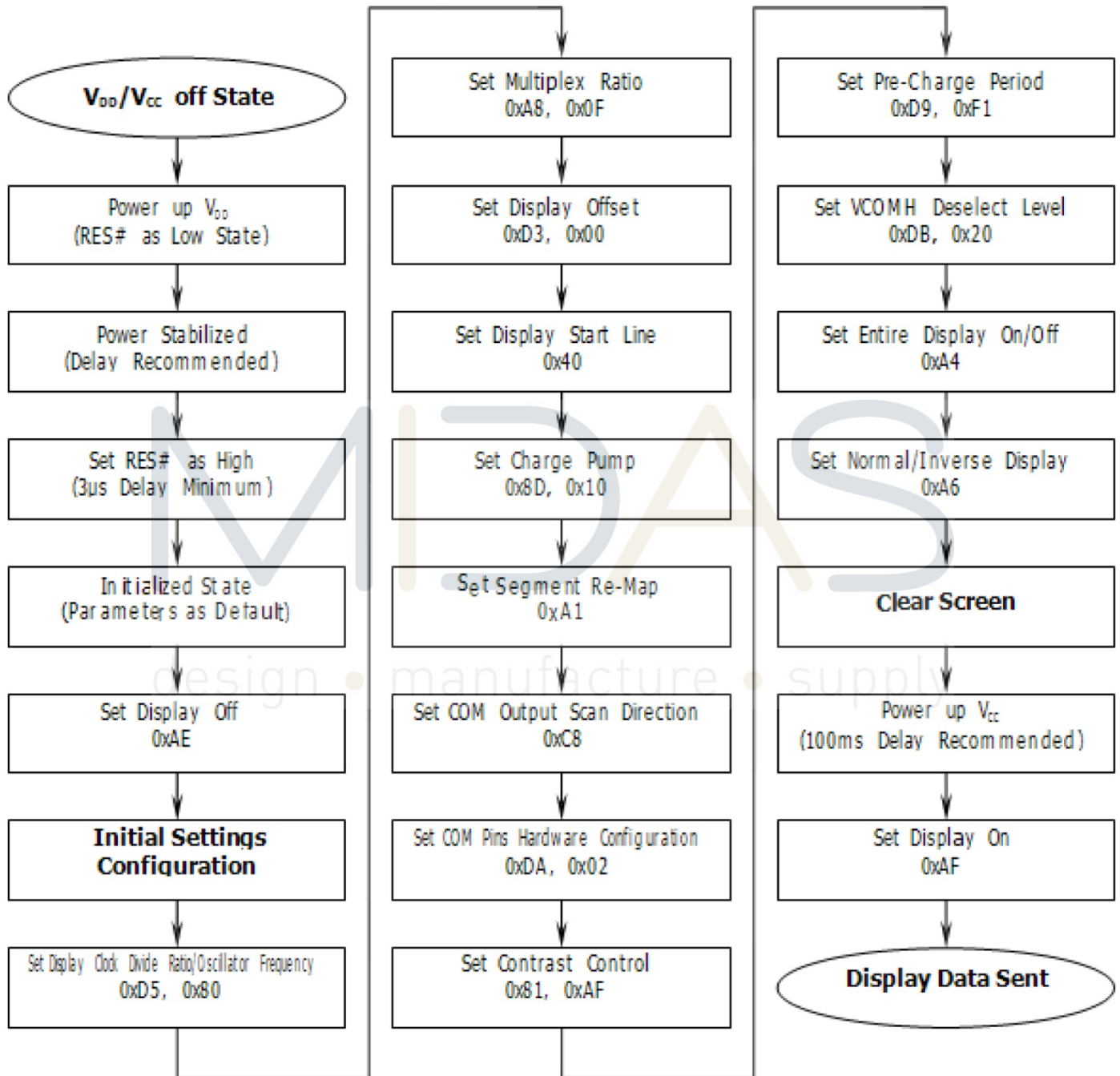

If the noise is accidentally occurred at the displaying window during the operation, please reset the display in order to recover the display function.

<Power down Sequence>

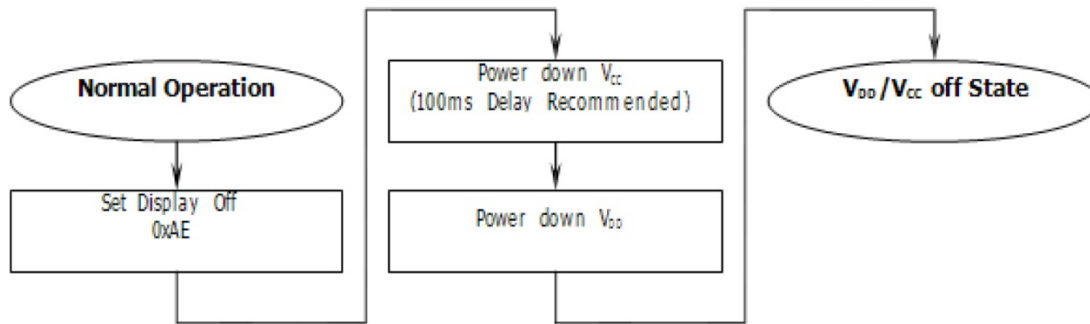

<Entering Sleep Mode>

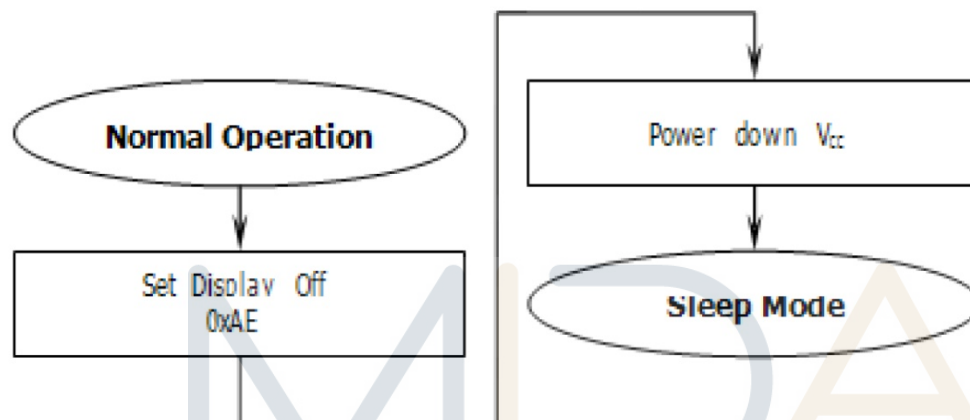

<Exiting Sleep Mode>

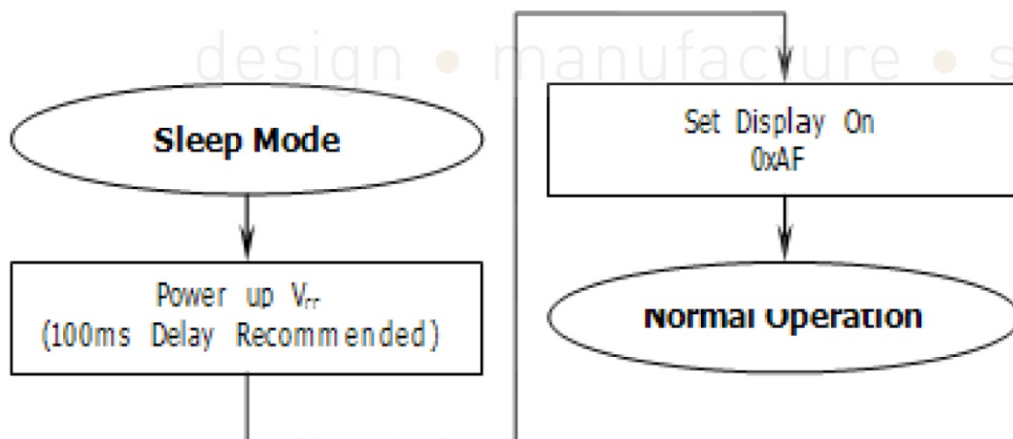

## X-ON Electronics

Largest Supplier of Electrical and Electronic Components

*Click to view similar products for [midas](#) manufacturer:*

Other Similar products are found below :

[MCT070LA12W1024600LML](#) [MCOT128064BY-WM](#) [MCOB21609AV-EWP](#) [MC42004A6W-SPTLY](#) [MC22008B6W-SPR](#)

[MCT035G12W320240LML](#) [MC11605A6WR-SPTLY-V2](#) [MC21605H6W-BNMLW-V2](#) [MCOT048064A1V-YI](#)

[MCT101E0CW1280800LMLIPS](#) [MCT104A0W1024768LML](#) [MCT070Z0W800480LML](#) [MCT0144C6W128128PML](#) [MCIB-16-LVDS-](#)

[CABLE](#) [MC41605A6W-FPTLA-V2](#) [MCOT128064UA1V-WM](#) [MCT101E0TW1280800LMLIPS](#) [MCT150B0W1024768LML](#)

[MCT050HDMI-A-RTP](#) [MCT050HDMI-A-CTP](#) [MCT070Z0TW1W800480LML](#) [MCT050ACA0CW800480LML](#) [MC42008A6W-SPTLY](#)

[MC42005A12W-VNMLY](#) [MC42005A12W-VNMLG](#) [MCT052A6W480128LML](#) [MC21605A6WK-BNMLW-V2](#) [MCOT256064A1A-BM](#)

[MCOT22005A1V-EYM](#) [MC20805A12W-VNMLG](#) [MC21605B6WD-BNMLW-V2](#) [MC22405A6WK-BNMLW-V2](#) [MC41605A6WK-](#)

[FPTLW-V2](#) [MCT101HDMI-A-RTP](#) [MCT024L6W240320PML](#) [MCCOG21605D6W-FPTLWI](#) [MC21605A6WD-SPTLY-V2](#)

[MC22005A6WK-BNMLW-V2](#) [MC24005AA6W9-BNMLW-V2](#) [MC42004A6WK-SPTLY-V2](#) [MC11609A6W-SPTLY-V2](#)

[MCOT064048A1V-YM](#) [MCOT128064BY-BM](#) [MCCOG128064B12W-FPTLRGB](#) [MC11609A6W-SPR-V2](#) [MC21605H6WK-BNMLW-V2](#)

[MCOT128064E1V-BM](#) [MCT070HDMI-B-RTP](#) [MDT5000C](#) [MCCOG42005A6W-BNMLWI](#)