

FEATURES

- High performance member of pin-compatible TxDAC product family
- Excellent spurious-free dynamic range performance
- SNR at 5 MHz output, 125 MSPS: 65 dB
- Twos complement or straight binary data format
- Differential current outputs: 2 mA to 20 mA
- Power dissipation: 135 mW at 3.3 V
- Power-down mode: 15 mW at 3.3 V
- On-chip 1.2 V reference
- CMOS-compatible digital interface
- 28-lead TSSOP package
- Edge-triggered latches
- Qualified for automotive applications

APPLICATIONS

- Wideband communication transmit channel
 - Direct IF
 - Base stations
 - Wireless local loops
 - Digital radio links
 - Direct digital synthesis (DDS)
 - Instrumentation

GENERAL DESCRIPTION

The AD9740W¹ is a 10-bit resolution, wideband, third generation member of the TxDAC® series of high performance, low power CMOS digital-to-analog converters (DACs). The TxDAC family, consisting of pin-compatible 8-, 10-, 12-, and 14-bit DACs, is specifically optimized for the transmit signal path of communication systems. All of the devices share the same interface options, small outline package, and pinout, providing an upward or downward component selection path based on performance, resolution, and cost. The AD9740W offers exceptional ac and dc performance while supporting update rates up to 210 MSPS.

The AD9740W's low power dissipation makes it well suited for portable and low power applications. Its power dissipation can be further reduced to 60 mW with a slight degradation in performance by lowering the full-scale current output. In addition, a power-down mode reduces the standby power dissipation to approximately 15 mW. A segmented current source architecture is combined with a proprietary switching technique to reduce spurious components and enhance dynamic performance.

FUNCTIONAL BLOCK DIAGRAM

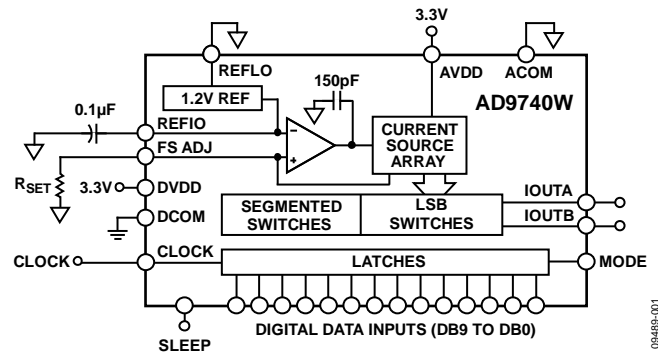

Figure 1.

Edge-triggered input latches and a 1.2 V temperature-compensated band gap reference have been integrated to provide a complete monolithic DAC solution. The digital inputs support 3 V CMOS logic families.

PRODUCT HIGHLIGHTS

1. The AD9740W is the 10-bit member of the pin-compatible TxDAC family, which offers excellent INL and DNL performance.
2. Data input supports twos complement or straight binary data coding.
3. High speed, single-ended CMOS clock input supports 210 MSPS conversion rate.
4. Low power: Complete CMOS DAC function operates on 135 mW from a 2.7 V to 3.6 V single supply. The DAC full-scale current can be reduced for lower power operation, and a sleep mode is provided for low power idle periods.
5. On-chip voltage reference: The AD9740W includes a 1.2 V temperature-compensated band gap voltage reference.
6. Industry-standard 28-lead TSSOP package.

¹ Protected by U.S. Patent Numbers 5568145, 5689257, and 5703519.

Rev. 0

Information furnished by Analog Devices is believed to be accurate and reliable. However, no responsibility is assumed by Analog Devices for its use, nor for any infringements of patents or other rights of third parties that may result from its use. Specifications subject to change without notice. No license is granted by implication or otherwise under any patent or patent rights of Analog Devices. Trademarks and registered trademarks are the property of their respective owners.

TABLE OF CONTENTS

Features	1	Reference Control Amplifier	13
Applications	1	DAC Transfer Function	13
Functional Block Diagram	1	Analog Outputs	13
General Description	1	Digital Inputs	14
Product Highlights	1	Clock Input	14
Revision History	2	DAC Timing	14
Specifications	3	Power Dissipation	15
DC Specifications	3	Applying the AD9740W	15
Dynamic Specifications	4	Differential Coupling Using a Transformer	15
Digital Specifications	5	Differential Coupling Using an Op Amp	15
Absolute Maximum Ratings	6	Single-Ended, Unbuffered Voltage Output	16
Thermal Characteristics	6	Single-Ended, Buffered Voltage Output Configuration	16
ESD Caution	6	Power and Grounding Considerations, Power Supply Rejection	16
Pin Configuration and Function Descriptions	7	Outline Dimensions	18
Terminology	8	Ordering Guide	18
Typical Performance Characteristics	9	Automotive Products	18
Functional Description	12		
Reference Operation	12		

REVISION HISTORY

12/10—Revision 0: Initial Version

SPECIFICATIONS

DC SPECIFICATIONS

T_{MIN} to T_{MAX} , $AVDD = 3.3$ V, $DVDD = 3.3$ V, $I_{OUTFS} = 20$ mA, unless otherwise noted.

Table 1.

Parameter	Min	Typ	Max	Unit
RESOLUTION	10			Bits
DC ACCURACY ¹				
Integral Linearity Error (INL)	−0.75	±0.15	+0.75	LSB
Differential Nonlinearity (DNL)	−0.5	±0.12	+0.5	LSB
ANALOG OUTPUT				
Offset Error	−0.02		+0.02	% of FSR
Gain Error (Without Internal Reference)	−2	±0.1	+2	% of FSR
Gain Error (With Internal Reference)	−2	±0.1	+2	% of FSR
Full-Scale Output Current ²	2		20	mA
Output Compliance Range	−1		+1.25	V
Output Resistance		100		kΩ
Output Capacitance		5		pF
REFERENCE OUTPUT				
Reference Voltage	1.14	1.20	1.26	V
Reference Output Current ³		100		nA
REFERENCE INPUT				
Input Compliance Range	0.1		1.25	V
Reference Input Resistance (External Reference)		7		kΩ
Small Signal Bandwidth		0.5		MHz
TEMPERATURE COEFFICIENTS				
Offset Drift		0		ppm of FSR/°C
Gain Drift (Without Internal Reference)		±50		ppm of FSR/°C
Gain Drift (With Internal Reference)		±100		ppm of FSR/°C
Reference Voltage Drift		±50		ppm/°C
POWER SUPPLY				
Supply Voltages				
AVDD	2.7	3.3	3.6	V
DVDD	2.7	3.3	3.6	V
Analog Supply Current (I_{AVDD})		33	36	mA
Digital Supply Current (I_{DVDD}) ⁴		8	9	mA
Supply Current Sleep Mode (I_{AVDD})		5	6	mA
Power Dissipation ⁴		135	145	mW
Power Dissipation ⁵		145		mW
Power Supply Rejection Ratio—AVDD ⁶	−1		+1	% of FSR/V
Power Supply Rejection Ratio—DVDD ⁶	−0.04		+0.04	% of FSR/V
OPERATING RANGE	−40		+105	°C

¹ Measured at IOUTA, driving a virtual ground.

² Nominal full-scale current, I_{OUTFS} , is 32 times the I_{REF} current.

³ An external buffer amplifier with input bias current <100 nA should be used to drive any external load.

⁴ Measured at $f_{CLOCK} = 25$ MSPS and $f_{OUT} = 1$ MHz.

⁵ Measured as unbuffered voltage output with $I_{OUTFS} = 20$ mA, $50 \Omega R_{LOAD}$ at IOUTA and IOUTB, $f_{CLOCK} = 100$ MSPS, and $f_{OUT} = 40$ MHz.

⁶ ±5% power supply variation.

AD9740W

DYNAMIC SPECIFICATIONS

T_{MIN} to T_{MAX} , $AVDD = 3.3\text{ V}$, $DVDD = 3.3\text{ V}$, $I_{OUTFS} = 20\text{ mA}$, differential transformer coupled output, $50\ \Omega$ doubly terminated, unless otherwise noted.

Table 2.

Parameter	Min	Typ	Max	Unit
DYNAMIC PERFORMANCE				
Maximum Output Update Rate (f_{CLOCK})	210			MSPS
Output Settling Time (t_{ST}) (to 0.1%) ¹		11		ns
Output Propagation Delay (t_{PD})		1		ns
Glitch Impulse		5		pV-s
Output Rise Time (10% to 90%) ¹		2.5		ns
Output Fall Time (10% to 90%) ¹		2.5		ns
Output Noise ($I_{OUTFS} = 20\text{ mA}$) ²		50		pA/ $\sqrt{\text{Hz}}$
Output Noise ($I_{OUTFS} = 2\text{ mA}$) ²		30		pA/ $\sqrt{\text{Hz}}$
Noise Spectral Density ³		-143		dBm/Hz
AC LINEARITY				
Spurious-Free Dynamic Range to Nyquist				
$f_{CLOCK} = 25\text{ MSPS}$; $f_{OUT} = 1.00\text{ MHz}$				
0 dBFS Output	66	79		dBc
-6 dBFS Output		75		dBc
-12 dBFS Output		67		dBc
-18 dBFS Output		61		dBc
$f_{CLOCK} = 65\text{ MSPS}$; $f_{OUT} = 1.00\text{ MHz}$		84		dBc
$f_{CLOCK} = 65\text{ MSPS}$; $f_{OUT} = 2.51\text{ MHz}$		80		dBc
$f_{CLOCK} = 65\text{ MSPS}$; $f_{OUT} = 10\text{ MHz}$		78		dBc
$f_{CLOCK} = 65\text{ MSPS}$; $f_{OUT} = 15\text{ MHz}$		76		dBc
$f_{CLOCK} = 65\text{ MSPS}$; $f_{OUT} = 25\text{ MHz}$		75		dBc
$f_{CLOCK} = 165\text{ MSPS}$; $f_{OUT} = 21\text{ MHz}$		70		dBc
$f_{CLOCK} = 165\text{ MSPS}$; $f_{OUT} = 41\text{ MHz}$		60		dBc
$f_{CLOCK} = 210\text{ MSPS}$; $f_{OUT} = 40\text{ MHz}$		67		dBc
$f_{CLOCK} = 210\text{ MSPS}$; $f_{OUT} = 69\text{ MHz}$		63		dBc
Spurious-Free Dynamic Range within a Window				
$f_{CLOCK} = 25\text{ MSPS}$; $f_{OUT} = 1.00\text{ MHz}$; 2 MHz Span	79			dBc
$f_{CLOCK} = 50\text{ MSPS}$; $f_{OUT} = 5.02\text{ MHz}$; 2 MHz Span		90		dBc
$f_{CLOCK} = 65\text{ MSPS}$; $f_{OUT} = 5.03\text{ MHz}$; 2.5 MHz Span		90		dBc
$f_{CLOCK} = 125\text{ MSPS}$; $f_{OUT} = 5.04\text{ MHz}$; 4 MHz Span		90		dBc
Total Harmonic Distortion				
$f_{CLOCK} = 25\text{ MSPS}$; $f_{OUT} = 1.00\text{ MHz}$		-79	-65	dBc
$f_{CLOCK} = 50\text{ MSPS}$; $f_{OUT} = 2.00\text{ MHz}$		-77		dBc
$f_{CLOCK} = 65\text{ MSPS}$; $f_{OUT} = 2.00\text{ MHz}$		-77		dBc
$f_{CLOCK} = 125\text{ MSPS}$; $f_{OUT} = 2.00\text{ MHz}$		-77		dBc
Signal-to-Noise Ratio				
$f_{CLOCK} = 65\text{ MSPS}$; $f_{OUT} = 5\text{ MHz}$; $I_{OUTFS} = 20\text{ mA}$		68		dB
$f_{CLOCK} = 65\text{ MSPS}$; $f_{OUT} = 5\text{ MHz}$; $I_{OUTFS} = 5\text{ mA}$		64		dB
$f_{CLOCK} = 125\text{ MSPS}$; $f_{OUT} = 5\text{ MHz}$; $I_{OUTFS} = 20\text{ mA}$		64		dB
$f_{CLOCK} = 125\text{ MSPS}$; $f_{OUT} = 5\text{ MHz}$; $I_{OUTFS} = 5\text{ mA}$		62		dB
$f_{CLOCK} = 165\text{ MSPS}$; $f_{OUT} = 5\text{ MHz}$; $I_{OUTFS} = 20\text{ mA}$		64		dB
$f_{CLOCK} = 165\text{ MSPS}$; $f_{OUT} = 5\text{ MHz}$; $I_{OUTFS} = 5\text{ mA}$		62		dB
$f_{CLOCK} = 210\text{ MSPS}$; $f_{OUT} = 5\text{ MHz}$; $I_{OUTFS} = 20\text{ mA}$		63		dB
$f_{CLOCK} = 210\text{ MSPS}$; $f_{OUT} = 5\text{ MHz}$; $I_{OUTFS} = 5\text{ mA}$		60		dB

Parameter	Min	Typ	Max	Unit
Multitone Power Ratio (8 Tones at 400 kHz Spacing) f _{CLOCK} = 78 MSPS; f _{OUT} = 15.0 MHz to 18.2 MHz				
0 dBFS Output		65		dBc
-6 dBFS Output		66		dBc
-12 dBFS Output		60		dBc
-18 dBFS Output		55		dBc

¹ Measured single-ended into 50 Ω load.
² Output noise is measured with a full-scale output set to 20 mA with no conversion activity. It is a measure of the thermal noise only.
³ Noise spectral density is the average noise power normalized to a 1 Hz bandwidth, with the DAC converting and producing an output tone.

DIGITAL SPECIFICATIONS

T_{MIN} to T_{MAX}, AVDD = 3.3 V, DVDD = 3.3 V, I_{OUTES} = 20 mA, unless otherwise noted.

Table 3.

Parameter	Min	Typ	Max	Unit
DIGITAL INPUTS ¹				
Logic 1 Voltage	2.1	3		V
Logic 0 Voltage		0	0.9	V
Logic 1 Current	-10		+10	μA
Logic 0 Current	-10		+10	μA
Input Capacitance		5		pF
Input Setup Time (t _S)	2.0			ns
Input Hold Time (t _H)	1.5			ns
Latch Pulse Width (t _{LPW})	1.5			ns

¹ Includes CLOCK pin in single-ended clock input mode.

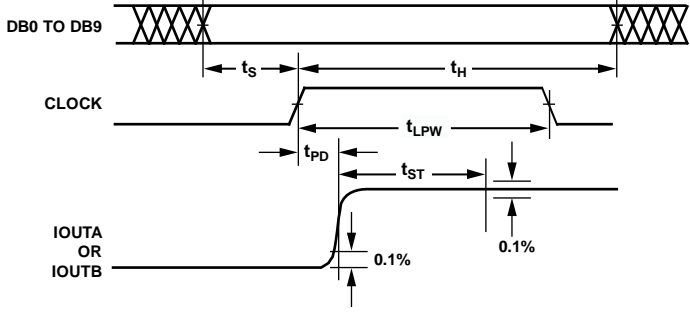

Figure 2. Timing Diagram

094489-002

ABSOLUTE MAXIMUM RATINGS

Table 4.

Parameter	With Respect to	Min	Max	Unit
AVDD	ACOM	-0.3	+3.9	V
DVDD	DCOM	-0.3	+3.9	V
ACOM	DCOM	-0.3	+0.3	V
AVDD	DVDD	-3.9	+3.9	V
CLOCK, SLEEP	DCOM	-0.3	DVDD + 0.3	V
Digital Inputs, MODE	DCOM	-0.3	DVDD + 0.3	V
IOUTA, IOUTB	ACOM	-1.0	AVDD + 0.3	V
REFIO, REFLO, FS ADJ	ACOM	-0.3	AVDD + 0.3	V
Junction Temperature			150	°C
Storage Temperature Range		-65	+150	°C
Lead Temperature (10 sec)			300	°C

Stresses above those listed under Absolute Maximum Ratings may cause permanent damage to the device. This is a stress rating only; functional operation of the device at these or any other conditions above those indicated in the operational sections of this specification is not implied. Exposure to absolute maximum ratings for extended periods may affect device reliability.

THERMAL CHARACTERISTICS

Thermal Resistance

Table 5. Thermal Resistance¹

Package Type	θ_{JA}	Unit
28-Lead TSSOP	67.7	°C/W

¹ Thermal impedance measurements were taken on a 4-layer board in still air, in accordance with EIA/JESD51-7.

ESD CAUTION



ESD (electrostatic discharge) sensitive device.

Charged devices and circuit boards can discharge without detection. Although this product features patented or proprietary protection circuitry, damage may occur on devices subjected to high energy ESD. Therefore, proper ESD precautions should be taken to avoid performance degradation or loss of functionality.

PIN CONFIGURATION AND FUNCTION DESCRIPTIONS

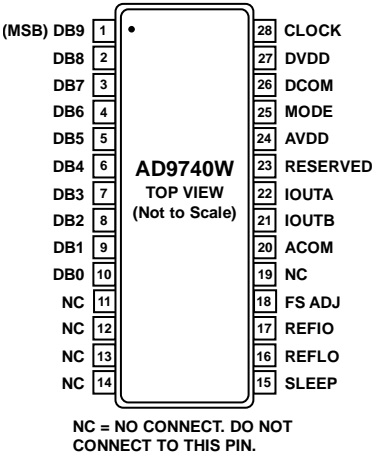

Figure 3. Pin Configuration

Table 6. Pin Function Descriptions

Pin No.	Mnemonic	Description
1	DB9 (MSB)	Most Significant Data Bit (MSB).
2 to 9	DB8 to DB1	Data Bits 8 to 1.
10	DB0 (LSB)	Least Significant Data Bit (LSB).
11 to 14, 19	NC	No Internal Connection.
15	SLEEP	Power-Down Control Input. Active high. Contains active pull-down circuit; it can be left unterminated if not used.
16	REFLO	Reference Ground when Internal 1.2 V Reference Used. Connect to ACOM for both internal and external reference operation modes.
17	REFIO	Reference Input/Output. Serves as reference input when using external reference. Serves as 1.2 V reference output when using internal reference. Requires 0.1 μF capacitor to ACOM when using internal reference.
18	FS ADJ	Full-Scale Current Output Adjust.
20	ACOM	Analog Common.
21	IOUTB	Complementary DAC Current Output. Full-scale current when all data bits are 0s.
22	IOUTA	DAC Current Output. Full-scale current when all data bits are 1s.
23	RESERVED	Reserved. Do Not Connect to Common or Supply.
24	AVDD	Analog Supply Voltage (3.3 V).
25	MODE	Selects Input Data Format. Connect to DCOM for straight binary, DVDD for twos complement.
26	DCOM	Digital Common.
27	DVDD	Digital Supply Voltage (3.3 V).
28	CLOCK	Clock Input. Data latched on positive edge of clock.

TERMINOLOGY

Linearity Error (Also Called Integral Nonlinearity or INL)

Linearity error is defined as the maximum deviation of the actual analog output from the ideal output, determined by a straight line drawn from zero to full scale.

Differential Nonlinearity (or DNL)

DNL is the measure of the variation in analog value, normalized to full scale, associated with a 1 LSB change in digital input code.

Monotonicity

A DAC is monotonic if the output either increases or remains constant as the digital input increases.

Offset Error

The deviation of the output current from the ideal of zero is called the offset error. For IOUTA, 0 mA output is expected when the inputs are all 0s. For IOUTB, 0 mA output is expected when all inputs are set to 1s.

Gain Error

The difference between the actual and ideal output span. The actual span is determined by the output when all inputs are set to 1s minus the output when all inputs are set to 0s.

Output Compliance Range

The range of allowable voltage at the output of a current output DAC. Operation beyond the maximum compliance limits can cause either output stage saturation or breakdown, resulting in nonlinear performance.

Temperature Drift

Temperature drift is specified as the maximum change from the ambient (25°C) value to the value at either T_{MIN} or T_{MAX} . For offset and gain drift, the drift is reported in ppm of full-scale range (FSR) per °C. For reference drift, the drift is reported in ppm per °C.

Power Supply Rejection

The maximum change in the full-scale output as the supplies are varied from nominal to minimum and maximum specified voltages.

Settling Time

The time required for the output to reach and remain within a specified error band about its final value, measured from the start of the output transition.

Glitch Impulse

Asymmetrical switching times in a DAC give rise to undesired output transients that are quantified by a glitch impulse. It is specified as the net area of the glitch in pV-s.

Spurious-Free Dynamic Range

The difference, in dB, between the rms amplitude of the output signal and the peak spurious signal over the specified bandwidth.

Total Harmonic Distortion (THD)

THD is the ratio of the rms sum of the first six harmonic components to the rms value of the measured input signal. It is expressed as a percentage or in decibels (dB).

Multitone Power Ratio

The spurious-free dynamic range containing multiple carrier tones of equal amplitude. It is measured as the difference between the rms amplitude of a carrier tone to the peak spurious signal in the region of a removed tone.

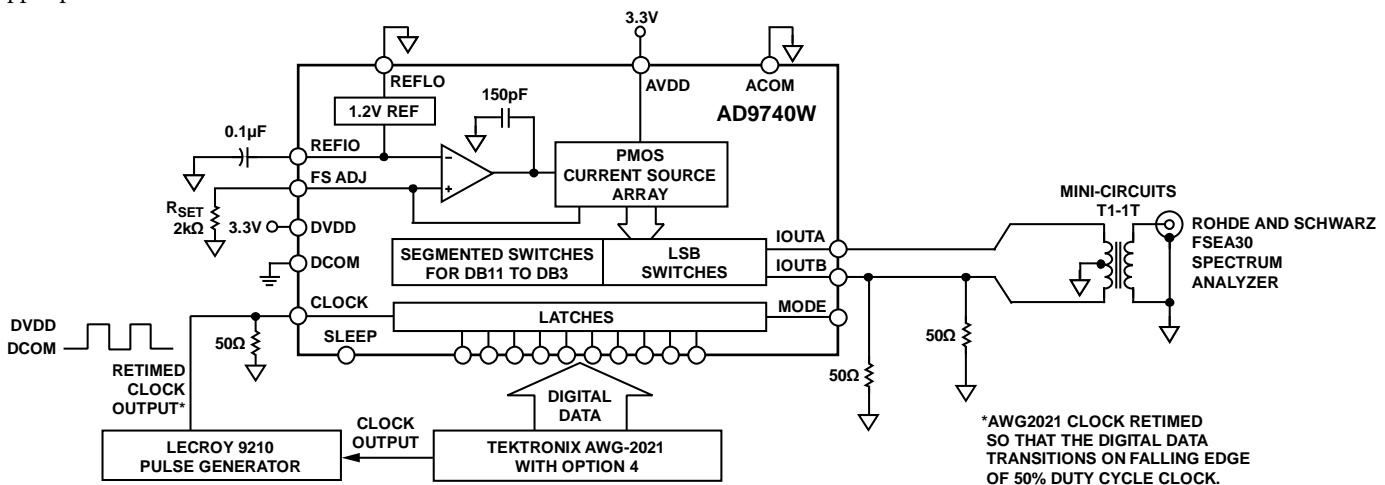

Figure 4. Basic AC Characterization Test Setup

TYPICAL PERFORMANCE CHARACTERISTICS

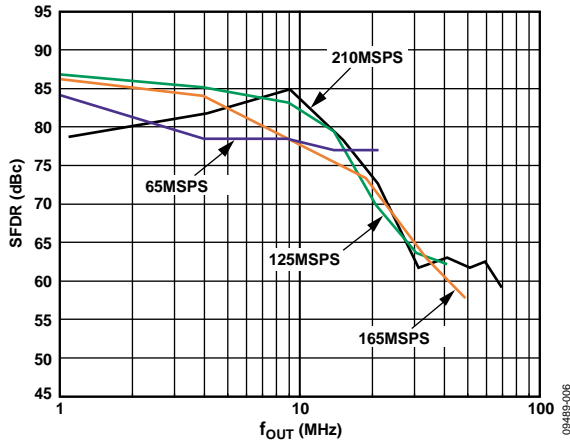

Figure 5. SFDR vs. f_{OUT} at 0 dBFS

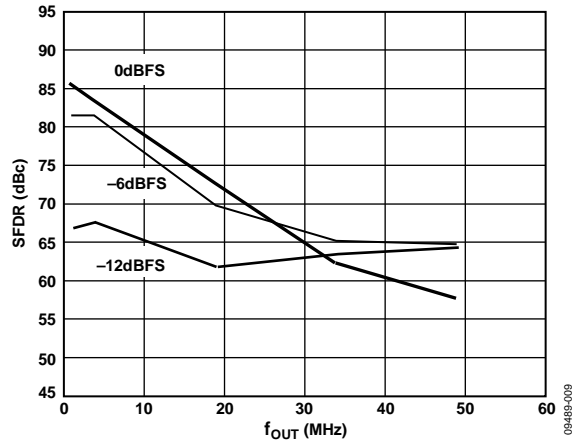

Figure 8. SFDR vs. f_{OUT} at 165 MSPS

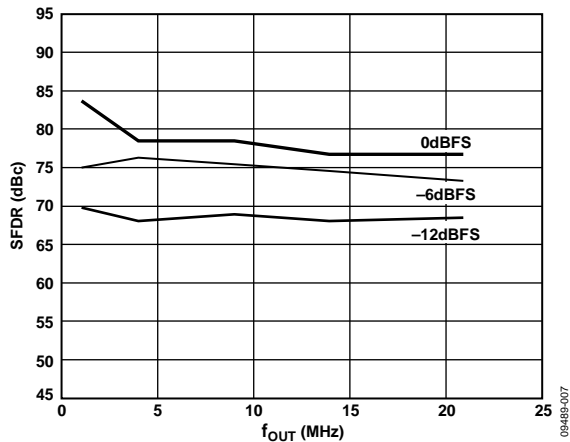

Figure 6. SFDR vs. f_{OUT} at 65 MSPS

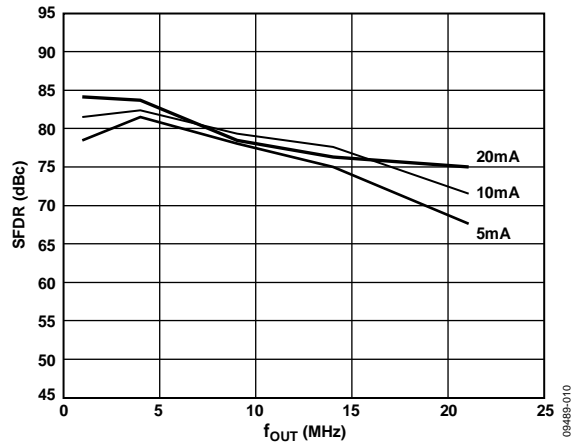

Figure 9. SFDR vs. f_{OUT} and I_{OUTS} at 65 MSPS and 0 dBFS

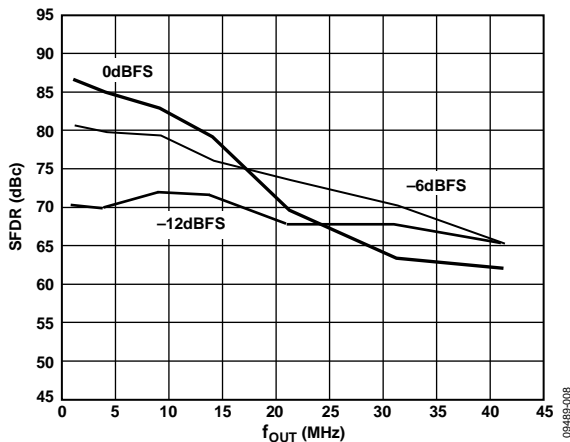

Figure 7. SFDR vs. f_{OUT} at 125 MSPS

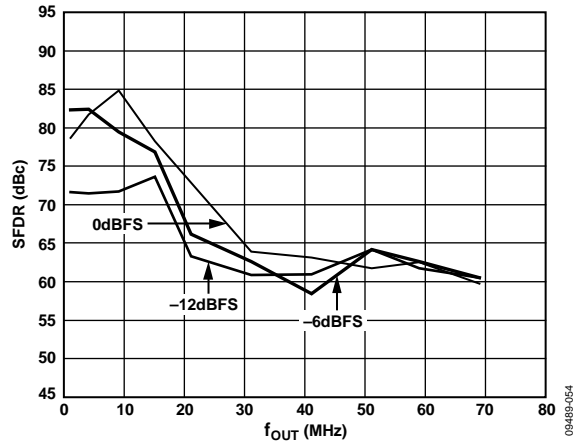

Figure 10. SFDR vs. f_{OUT} at 210 MSPS

AD9740W

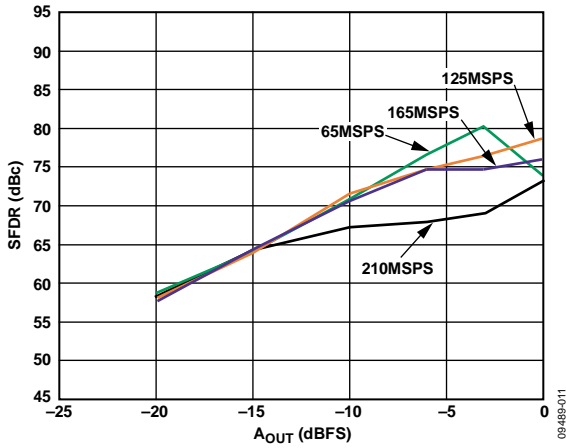

Figure 11. Single-Tone SFDR vs. A_{OUT} at $f_{OUT} = f_{CLOCK}/11$

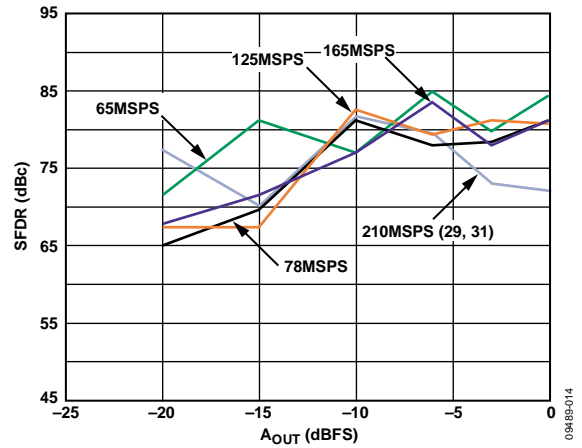

Figure 14. Dual-Tone IMD vs. A_{OUT} at $f_{OUT} = f_{CLOCK}/7$

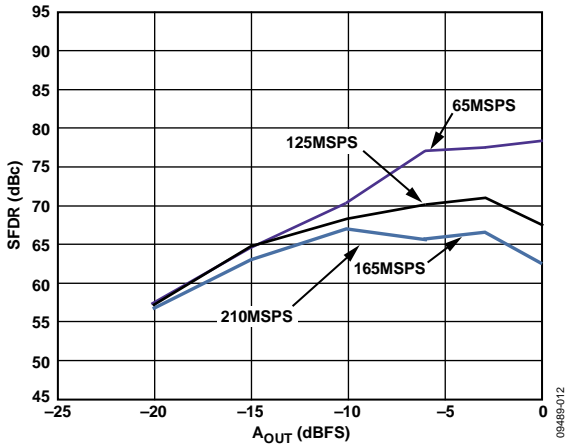

Figure 12. Single-Tone SFDR vs. A_{OUT} at $f_{OUT} = f_{CLOCK}/5$

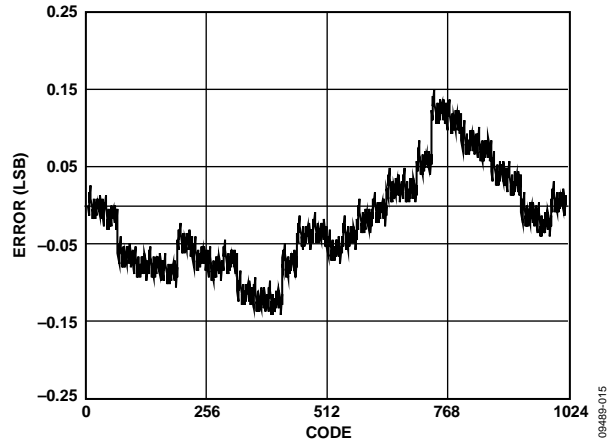

Figure 15. Typical INL

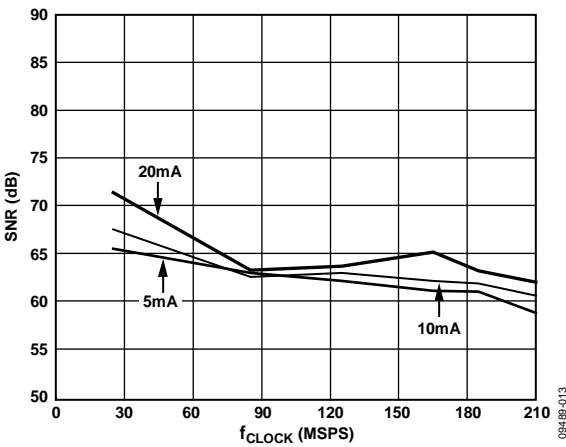

Figure 13. SNR vs. f_{CLOCK} and I_{OUTFS} at $f_{OUT} = 5$ MHz and 0 dBFS

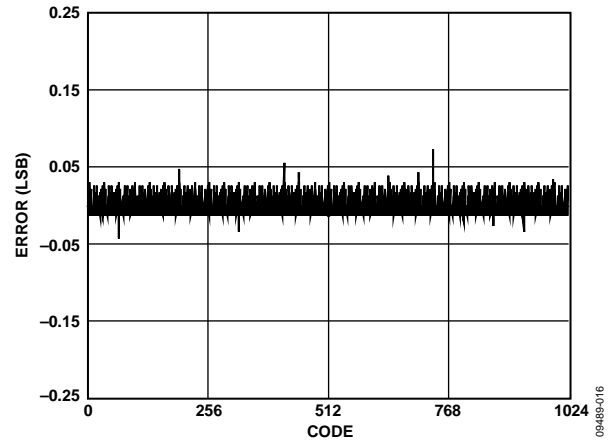

Figure 16. Typical DNL

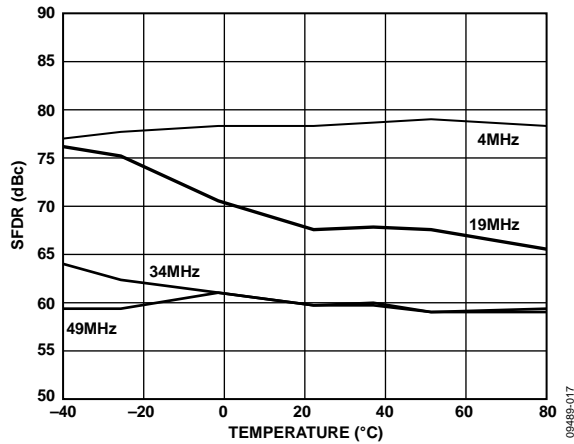

Figure 17. SFDR vs. Temperature at 165 MSPS, 0 dBFS

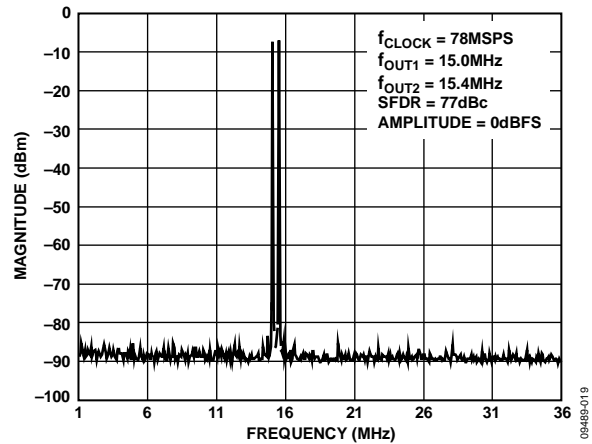

Figure 19. Dual-Tone SFDR

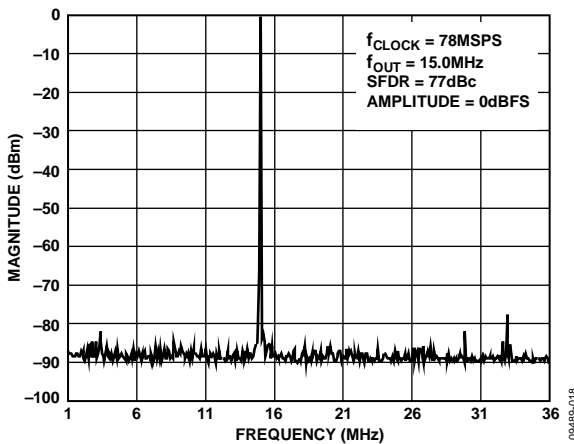

Figure 18. Single-Tone SFDR

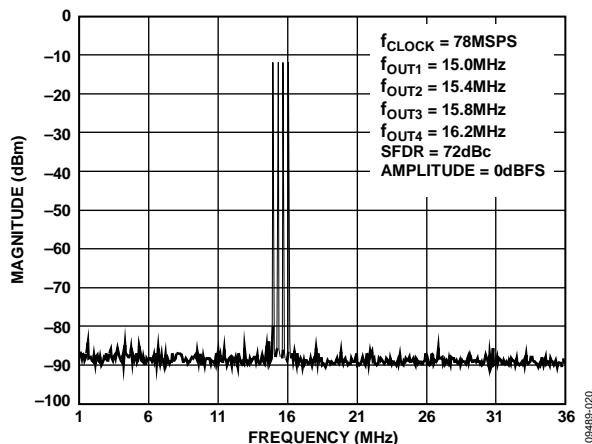

Figure 20. Four-Tone SFDR

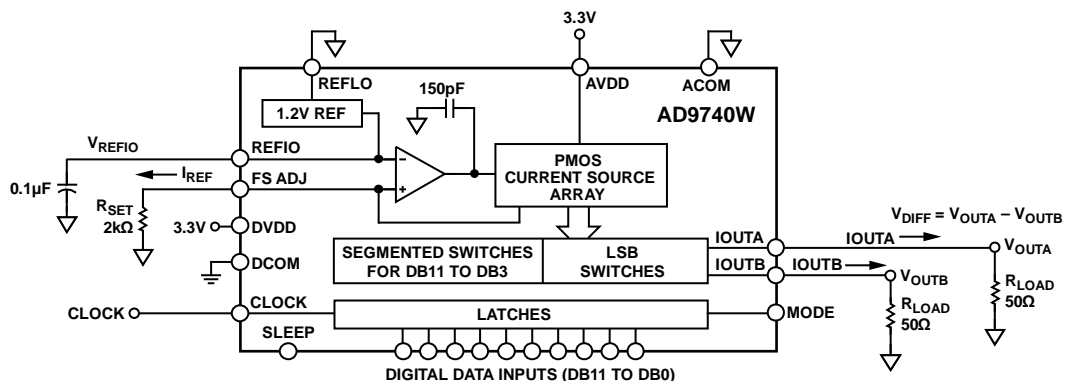

Figure 21. Simplified Block Diagram

FUNCTIONAL DESCRIPTION

Figure 21 shows a simplified block diagram of the AD9740W. The AD9740W consists of a DAC, digital control logic, and full-scale output current control. The DAC contains a PMOS current source array capable of providing up to 20 mA of full-scale current (I_{OUTFS}). The array is divided into 31 equal currents that make up the five most significant bits (MSBs). The next four bits, or middle bits, consist of 15 equal current sources whose value is 1/16 of an MSB current source. The remaining LSBs are binary weighted fractions of the middle bits current sources. Implementing the middle and lower bits with current sources, instead of an R-2R ladder, enhances its dynamic performance for multitone or low amplitude signals and helps maintain the DAC's high output impedance (that is, >100 k Ω).

All of these current sources are switched to one or the other of the two output nodes (that is, I_{OUTA} or I_{OUTB}) via PMOS differential current switches. The switches are based on the architecture that was pioneered in the AD9764 family, with further refinements to reduce distortion contributed by the switching transient. This switch architecture also reduces various timing errors and provides matching complementary drive signals to the inputs of the differential current switches.

The analog and digital sections of the AD9740W have separate power supply inputs (that is, AVDD and DVDD) that can operate independently over a 2.7 V to 3.6 V range. The digital section, which is capable of operating at a clock rate of up to 210 MSPS, consists of edge-triggered latches and segment decoding logic circuitry. The analog section includes the PMOS current sources, the associated differential switches, a 1.2 V band gap voltage reference, and a reference control amplifier.

The DAC full-scale output current is regulated by the reference control amplifier and can be set from 2 mA to 20 mA via an external resistor, R_{SET} , connected to the full-scale adjust (FS ADJ) pin. The external resistor, in combination with both the reference control amplifier and voltage reference, V_{REFIO} , sets the reference current, I_{REF} , which is replicated to the segmented current sources with the proper scaling factor. The full-scale current, I_{OUTFS} , is 32 times I_{REF} .

REFERENCE OPERATION

The AD9740W contains an internal 1.2 V band gap reference. The internal reference cannot be disabled, but can be easily overridden by an external reference with no effect on performance. Figure 22 shows an equivalent circuit of the band gap reference. REFIO serves as either an output or an input depending on whether the internal or an external reference is used. To use the internal reference, simply decouple the REFIO pin to ACOM with a 0.1 μ F capacitor and connect REFLO to ACOM via a resistance less than 5 Ω . The internal reference voltage is present at REFIO. If the voltage at REFIO is to be used anywhere else in the circuit, then an external buffer amplifier with an input bias current of less than 100 nA should be used. An example of the use of the internal reference is shown in Figure 24.

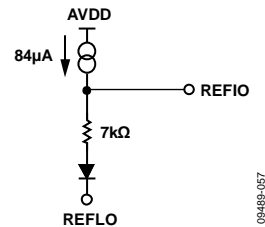

Figure 22. Equivalent Circuit of Internal Reference

An external reference can be applied to REFIO, as shown in Figure 23. The external reference can provide either a fixed reference voltage to enhance accuracy and drift performance or a varying reference voltage for gain control. Note that the 0.1 μ F compensation capacitor is not required because the internal reference is overridden, and the relatively high input impedance of REFIO minimizes any loading of the external reference.

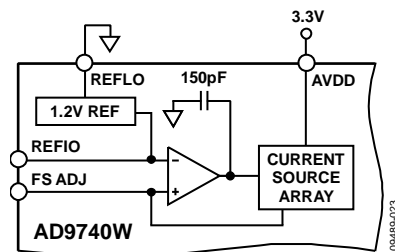

Figure 23. External Reference Configuration

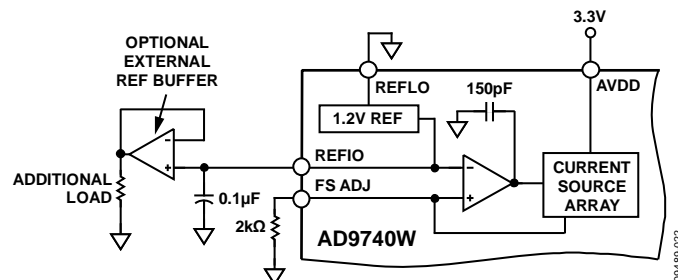

Figure 24. Internal Reference Configuration

REFERENCE CONTROL AMPLIFIER

The AD9740W contains a control amplifier that is used to regulate the full-scale output current, I_{OUTFS} . The control amplifier is configured as a V-I converter, as shown in Figure 24, so that its current output, I_{REF} , is determined by the ratio of the V_{REFIO} and an external resistor, R_{SET} , as stated in Equation 4. I_{REF} is copied to the segmented current sources with the proper scale factor to set I_{OUTFS} , as stated in Equation 3.

The control amplifier allows a wide (10:1) adjustment span of I_{OUTFS} over a 2 mA to 20 mA range by setting I_{REF} between 62.5 μ A and 625 μ A. The wide adjustment span of I_{OUTFS} provides several benefits. The first relates directly to the power dissipation of the AD9740W, which is proportional to I_{OUTFS} (see the Power Dissipation section). The second relates to a 20 dB adjustment, which is useful for system gain control purposes.

The small signal bandwidth of the reference control amplifier is approximately 500 kHz and can be used for low frequency small signal multiplying applications.

DAC TRANSFER FUNCTION

The AD9740W provides complementary current outputs, I_{OUTA} and I_{OUTB} . I_{OUTA} provides a near full-scale current output, I_{OUTFS} , when all bits are high (that is, $DAC\ CODE = 1023$), while I_{OUTB} , the complementary output, provides no current. The current output appearing at I_{OUTA} and I_{OUTB} is a function of both the input code and I_{OUTFS} and can be expressed as:

$$I_{OUTA} = (DAC\ CODE/1023) \times I_{OUTFS} \quad (1)$$

$$I_{OUTB} = (1023 - DAC\ CODE)/1024 \times I_{OUTFS} \quad (2)$$

where $DAC\ CODE = 0$ to 1023 (that is, decimal representation).

As mentioned previously, I_{OUTFS} is a function of the reference current I_{REF} , which is nominally set by a reference voltage, V_{REFIO} , and external resistor, R_{SET} . It can be expressed as:

$$I_{OUTFS} = 32 \times I_{REF} \quad (3)$$

where

$$I_{REF} = V_{REFIO}/R_{SET} \quad (4)$$

The two current outputs typically drive a resistive load directly or via a transformer. If dc coupling is required, then I_{OUTA} and I_{OUTB} should be directly connected to matching resistive loads, R_{LOAD} , that are tied to analog common, $ACOM$. Note that R_{LOAD} can represent the equivalent load resistance seen by I_{OUTA} or I_{OUTB} , as would be the case in a doubly terminated 50 Ω or 75 Ω cable. The single-ended voltage output appearing at the I_{OUTA} and I_{OUTB} nodes is simply

$$V_{OUTA} = I_{OUTA} \times R_{LOAD} \quad (5)$$

$$V_{OUTB} = I_{OUTB} \times R_{LOAD} \quad (6)$$

Note that the full-scale value of V_{OUTA} and V_{OUTB} should not exceed the specified output compliance range to maintain specified distortion and linearity performance.

$$V_{DIFF} = (I_{OUTA} - I_{OUTB}) \times R_{LOAD} \quad (7)$$

Substituting the values of I_{OUTA} , I_{OUTB} , I_{REF} , and V_{DIFF} can be expressed as:

$$V_{DIFF} = \{(2 \times DAC\ CODE - 1023)/1024\} \\ (32 \times R_{LOAD}/R_{SET}) \times V_{REFIO} \quad (8)$$

Equation 7 and Equation 8 highlight some of the advantages of operating the AD9740W differentially. First, the differential operation helps cancel common-mode error sources associated with I_{OUTA} and I_{OUTB} , such as noise, distortion, and dc offsets. Second, the differential code-dependent current and subsequent voltage, V_{DIFF} , is twice the value of the single-ended voltage output (that is, V_{OUTA} or V_{OUTB}), thus providing twice the signal power to the load.

Note that the gain drift temperature performance for a single-ended (V_{OUTA} and V_{OUTB}) or differential output (V_{DIFF}) of the AD9740W can be enhanced by selecting temperature tracking resistors for R_{LOAD} and R_{SET} due to their ratiometric relationship, as shown in Equation 8.

ANALOG OUTPUTS

The complementary current outputs in each DAC, I_{OUTA} , and I_{OUTB} can be configured for single-ended or differential operation. I_{OUTA} and I_{OUTB} can be converted into complementary single-ended voltage outputs, V_{OUTA} and V_{OUTB} , via a load resistor, R_{LOAD} , as described in the DAC Transfer Function section by Equation 5 through Equation 8. The differential voltage, V_{DIFF} , existing between V_{OUTA} and V_{OUTB} , can also be converted to a single-ended voltage via a transformer or differential amplifier configuration. The ac performance of the AD9740W is optimum and specified using a differential transformer-coupled output in which the voltage swing at I_{OUTA} and I_{OUTB} is limited to ± 0.5 V.

The distortion and noise performance of the AD9740W can be enhanced when it is configured for differential operation. The common-mode error sources of both I_{OUTA} and I_{OUTB} can be significantly reduced by the common-mode rejection of a transformer or differential amplifier. These common-mode error sources include even-order distortion products and noise. The enhancement in distortion performance becomes more significant as the frequency content of the reconstructed waveform increases and/or its amplitude decreases. This is due to the first-order cancellation of various dynamic common-mode distortion mechanisms, digital feedthrough, and noise.

Performing a differential-to-single-ended conversion via a transformer also provides the ability to deliver twice the reconstructed signal power to the load (assuming no source termination). Because the output currents of I_{OUTA} and I_{OUTB} are complementary, they become additive when processed differentially. A properly selected transformer allows the AD9740W to provide the required power and voltage levels to different loads.

The output impedance of I_{OUTA} and I_{OUTB} is determined by the equivalent parallel combination of the PMOS switches associated with the current sources and is typically 100 k Ω in

AD9740W

parallel with 5 pF. It is also slightly dependent on the output voltage (that is, V_{OUTA} and V_{OUTB}) due to the nature of a PMOS device. As a result, maintaining I_{OUTA} and/or I_{OUTB} at a virtual ground via an I-V op amp configuration results in the optimum dc linearity. Note that the INL/DNL specifications for the AD9740W are measured with I_{OUTA} maintained at a virtual ground via an op amp.

I_{OUTA} and I_{OUTB} also have a negative and positive voltage compliance range that must be adhered to in order to achieve optimum performance. The negative output compliance range of -1 V is set by the breakdown limits of the CMOS process. Operation beyond this maximum limit can result in a breakdown of the output stage and affect the reliability of the AD9740W.

The positive output compliance range is slightly dependent on the full-scale output current, I_{OUTFS} . It degrades slightly from its nominal 1.2 V for an $I_{OUTFS} = 20$ mA to 1 V for an $I_{OUTFS} = 2$ mA. The optimum distortion performance for a single-ended or differential output is achieved when the maximum full-scale signal at I_{OUTA} and I_{OUTB} does not exceed 0.5 V.

DIGITAL INPUTS

The AD9740W digital section consists of 10 input bit channels and a clock input. The 10-bit parallel data inputs follow standard positive binary coding, where DB9 is the most significant bit (MSB) and DB0 is the least significant bit (LSB). I_{OUTA} produces a full-scale output current when all data bits are at Logic 1. I_{OUTB} produces a complementary output with the full-scale current split between the two outputs as a function of the input code.

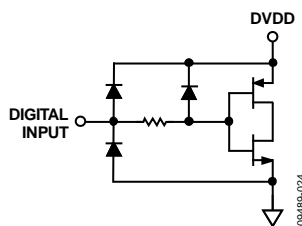

Figure 25. Equivalent Digital Input

The digital interface is implemented using an edge-triggered master/slave latch. The DAC output updates on the rising edge of the clock and is designed to support a clock rate as high as 210 MSPS. The clock can be operated at any duty cycle that meets the specified latch pulse width. The setup and hold times can also be varied within the clock cycle as long as the specified minimum times are met, although the location of these transition edges can affect digital feedthrough and distortion performance. Best performance is typically achieved when the input data transitions on the falling edge of a 50% duty cycle clock.

CLOCK INPUT

The 28-lead TSSOP package option has a single-ended clock input (CLOCK) that must be driven to rail-to-rail CMOS levels. The quality of the DAC output is directly related to the clock quality, and jitter is a key concern. Any noise or jitter in the clock translates directly into the DAC output. Optimal performance is achieved if the CLOCK input has a sharp rising edge, because the DAC latches are positive edge triggered.

DAC TIMING

Input Clock and Data Timing Relationship

Dynamic performance in a DAC is dependent on the relationship between the position of the clock edges and the time at which the input data changes. The AD9740W is rising edge triggered, and so exhibits dynamic performance sensitivity when the data transition is close to this edge. In general, the goal when applying the AD9740W is to make the data transition close to the falling clock edge. This becomes more important as the sample rate increases. Figure 26 shows the relationship of SFDR to clock placement with different sample rates. Note that at the lower sample rates, more tolerance is allowed in clock placement, while at higher rates, more care must be taken.

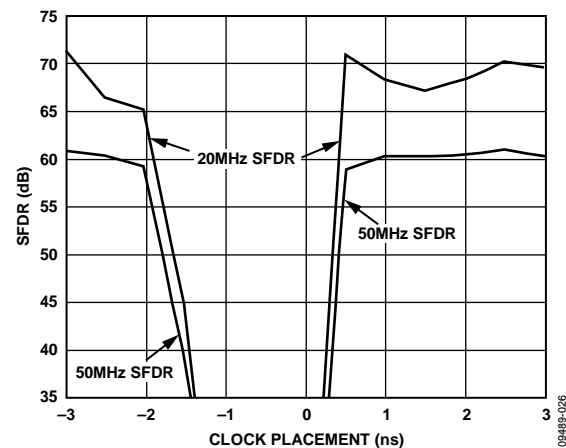

Figure 26. SFDR vs. Clock Placement @ $f_{OUT} = 20$ MHz and 50 MHz ($f_{CLOCK} = 165$ MSPS)

Sleep Mode Operation

The AD9740W has a power-down function that turns off the output current and reduces the supply current to less than 6 mA over the specified supply range of 2.7 V to 3.6 V and the temperature range. This mode can be activated by applying a Logic Level 1 to the SLEEP pin. The SLEEP pin logic threshold is equal to 0.5Ω AVDD. This digital input also contains an active pull-down circuit that ensures that the AD9740W remains enabled if this input is left disconnected. The AD9740W takes less than 50 ns to power down and approximately 5 μ s to power back up.

POWER DISSIPATION

The power dissipation, P_D , of the AD9740W is dependent on several factors that include:

- The power supply voltages (AVDD and DVDD)
- The full-scale current output (I_{OUTFS})
- The update rate (f_{CLOCK})
- The reconstructed digital input waveform

The power dissipation is directly proportional to the analog supply current, I_{AVDD} , and the digital supply current, I_{DVDD} . I_{AVDD} is directly proportional to I_{OUTFS} , as shown in Figure 27, and is insensitive to f_{CLOCK} . Conversely, I_{DVDD} is dependent on both the digital input waveform, f_{CLOCK} , and digital supply DVDD. Figure 28 shows I_{DVDD} as a function of full-scale sine wave output ratios (f_{OUT}/f_{CLOCK}) for various update rates with DVDD = 3.3 V.

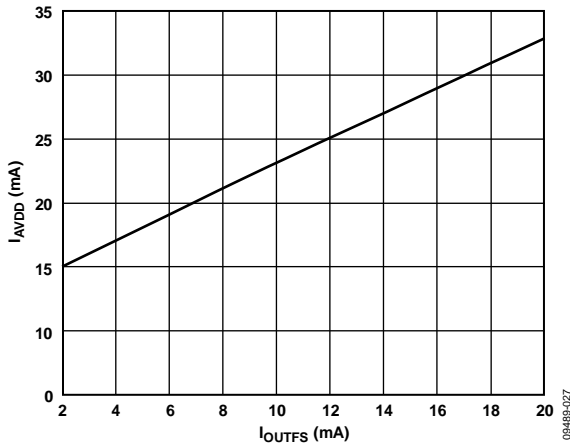

Figure 27. I_{AVDD} vs. I_{OUTFS}

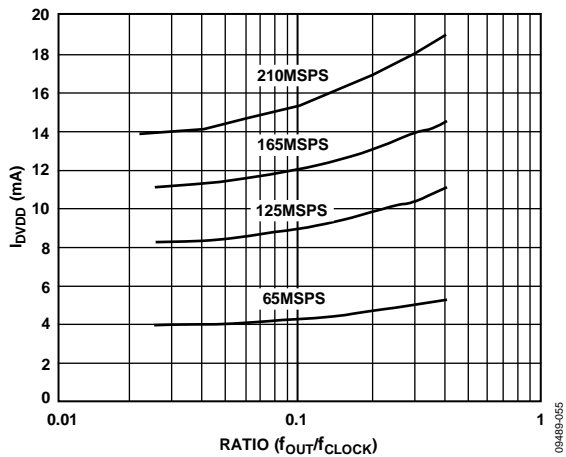

Figure 28. I_{DVDD} vs. Ratio at DVDD = 3.3 V

APPLYING THE AD9740W

Output Configurations

The following sections illustrate some typical output configurations for the AD9740W. Unless otherwise noted, it is assumed that I_{OUTFS} is set to a nominal 20 mA. For applications requiring the optimum dynamic performance, a differential output configuration is suggested. A differential output configuration can consist of either an RF transformer or a differential op amp

configuration. The transformer configuration provides the optimum high frequency performance and is recommended for any application that allows ac coupling. The differential op amp configuration is suitable for applications requiring dc coupling, bipolar output, signal gain, and/or level shifting within the bandwidth of the chosen op amp.

A single-ended output is suitable for applications requiring a unipolar voltage output. A positive unipolar output voltage results if I_{OUTA} and/or I_{OUTB} is connected to an appropriately sized load resistor, R_{LOAD} , referred to ACOM. This configuration can be more suitable for a single-supply system requiring a dc-coupled, ground referred output voltage. Alternatively, an amplifier could be configured as an I-V converter, thus converting I_{OUTA} or I_{OUTB} into a negative unipolar voltage. This configuration provides the best dc linearity because I_{OUTA} or I_{OUTB} is maintained at a virtual ground.

DIFFERENTIAL COUPLING USING A TRANSFORMER

An RF transformer can be used to perform a differential-to-single-ended signal conversion, as shown in Figure 29. A differentially coupled transformer output provides the optimum distortion performance for output signals whose spectral content lies within the transformer’s pass band. An RF transformer, such as the Mini-Circuits® T1-1T, provides excellent rejection of common-mode distortion (that is, even-order harmonics) and noise over a wide frequency range. It also provides electrical isolation and the ability to deliver twice the power to the load. Transformers with different impedance ratios can also be used for impedance matching purposes. Note that the transformer provides ac coupling only.

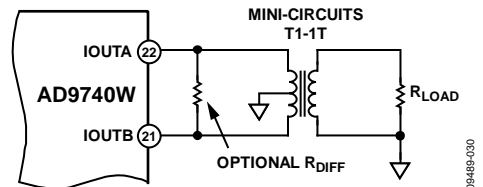

Figure 29. Differential Output Using a Transformer

The center tap on the primary side of the transformer must be connected to ACOM to provide the necessary dc current path for both I_{OUTA} and I_{OUTB} . The complementary voltages appearing at I_{OUTA} and I_{OUTB} (that is, V_{OUTA} and V_{OUTB}) swing symmetrically around ACOM and should be maintained with the specified output compliance range of the AD9740W. A differential resistor, R_{DIFF} , can be inserted in applications where the output of the transformer is connected to the load, R_{LOAD} , via a passive reconstruction filter or cable. R_{DIFF} is determined by the transformer’s impedance ratio and provides the proper source termination that results in a low VSWR. Note that approximately half the signal power is dissipated across R_{DIFF} .

DIFFERENTIAL COUPLING USING AN OP AMP

An op amp can also be used to perform a differential-to-single-ended conversion, as shown in Figure 30. The AD9740W is configured with two equal load resistors, R_{LOAD} , of 25 Ω . The

AD9740W

differential voltage developed across IOUTA and IOUTB is converted to a single-ended signal via the differential op amp configuration. An optional capacitor can be installed across IOUTA and IOUTB, forming a real pole in a low-pass filter. The addition of this capacitor also enhances the op amp's distortion performance by preventing the DAC's high slewing output from overloading the op amp's input.

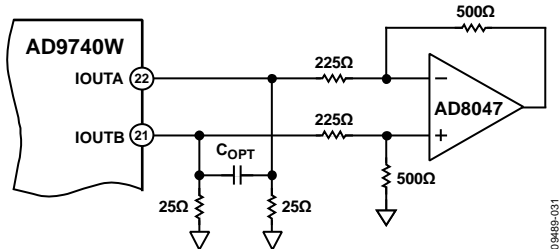

Figure 30. DC Differential Coupling Using an Op Amp

The common-mode rejection of this configuration is typically determined by the resistor matching. In this circuit, the differential op amp circuit using the AD8047 is configured to provide some additional signal gain. The op amp must operate off a dual supply because its output is approximately ± 1 V. A high speed amplifier capable of preserving the differential performance of the AD9740W while meeting other system level objectives (that is, cost or power) should be selected. The op amp's differential gain, gain setting resistor values, and full-scale output swing capabilities should all be considered when optimizing this circuit.

The differential circuit shown in Figure 31 provides the necessary level shifting required in a single-supply system. In this case, AVDD, which is the positive analog supply for both the AD9740W and the op amp, is also used to level shift the differential output of the AD9740W to midsupply (that is, AVDD/2). The AD8041 is a suitable op amp for this application.

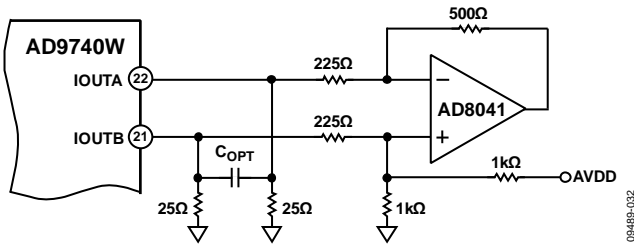

Figure 31. Single-Supply DC Differential Coupled Circuit

SINGLE-ENDED, UNBUFFERED VOLTAGE OUTPUT

Figure 32 shows the AD9740W configured to provide a unipolar output range of approximately 0 V to 0.5 V for a doubly terminated 50 Ω cable because the nominal full-scale current, IOUTFS, of 20 mA flows through the equivalent RLOAD of 25 Ω . In this case, RLOAD represents the equivalent load resistance seen by IOUTA or IOUTB. The unused output (IOUTA or IOUTB) can be connected to ACOM directly or via a matching RLOAD. Different values of IOUTFS and RLOAD can be selected as long as the positive compliance range is adhered to. One additional consideration in this mode is the integral nonlinearity (INL), discussed in the

Analog Outputs section. For optimum INL performance, the single-ended, buffered voltage output configuration is suggested.

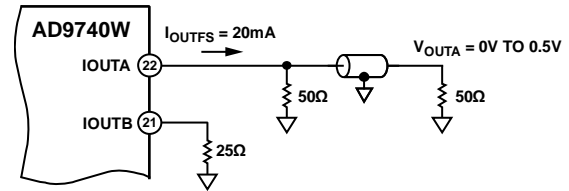

Figure 32. 0 V to 0.5 V Unbuffered Voltage Output

SINGLE-ENDED, BUFFERED VOLTAGE OUTPUT CONFIGURATION

Figure 33 shows a buffered single-ended output configuration in which the op amp U1 performs an I-V conversion on the AD9740W output current. U1 maintains IOUTA (or IOUTB) at a virtual ground, minimizing the nonlinear output impedance effect on the DAC's INL performance as described in the Analog Outputs section. Although this single-ended configuration typically provides the best dc linearity performance, its ac distortion performance at higher DAC update rates can be limited by U1's slew rate capabilities. U1 provides a negative unipolar output voltage, and its full-scale output voltage is simply the product of RFB and IOUTFS. The full-scale output should be set within U1's voltage output swing capabilities by scaling IOUTFS and/or RFB. An improvement in ac distortion performance can result with a reduced IOUTFS because U1 is required to sink less signal current.

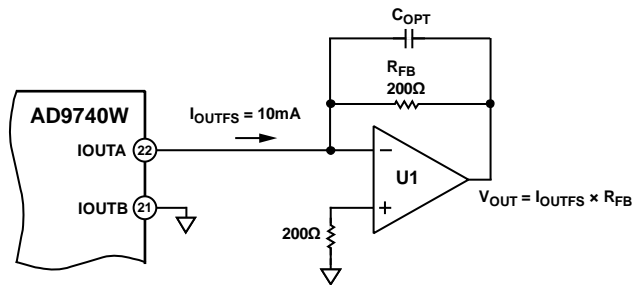

Figure 33. Unipolar Buffered Voltage Output

POWER AND GROUNDING CONSIDERATIONS, POWER SUPPLY REJECTION

Many applications seek high speed and high performance under less than ideal operating conditions. In these application circuits, the implementation and construction of the printed circuit board is as important as the circuit design. Proper RF techniques must be used for device selection, placement, and routing as well as power supply bypassing and grounding to ensure optimum performance.

One factor that can measurably affect system performance is the ability of the DAC output to reject dc variations or ac noise superimposed on the analog or digital dc power distribution. This is referred to as the power supply rejection ratio (PSRR). For dc variations of the power supply, the resulting performance of the DAC directly corresponds to a gain error associated with the DAC's full-scale current, IOUTFS. AC noise on the dc supplies is common in applications where the power distribution is

generated by a switching power supply. Typically, switching power supply noise occurs over the spectrum from tens of kilohertz to several megahertz. The PSRR vs. frequency of the AD9740W AVDD supply over this frequency range is shown in Figure 34.

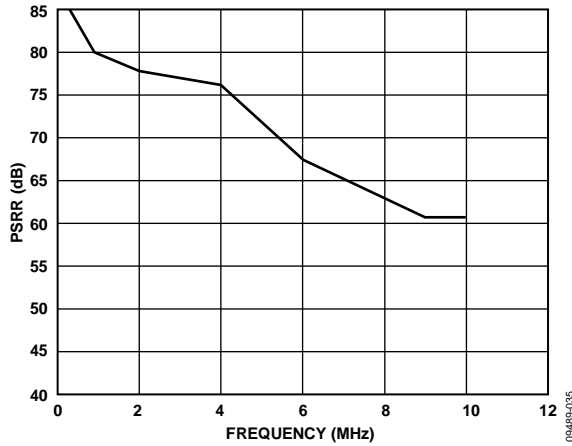

Figure 34. Power Supply Rejection Ratio (PSRR)

Note that the ratio in Figure 34 is calculated as amps out/volts in. Noise on the analog power supply has the effect of modulating the internal switches, and therefore the output current. The voltage noise on AVDD, therefore, is added in a nonlinear manner to the desired IO_{UT}. Due to the relative different size of these switches, the PSRR is very code dependent. This can produce a mixing effect that can modulate low frequency power supply noise to higher frequencies. Worst-case PSRR for either one of the differential DAC outputs occur when the full-scale current is directed toward that output.

As a result, the PSRR measurement in Figure 34 represents a worst-case condition in which the digital inputs remain static and the full-scale output current of 20 mA is directed to the DAC output being measured.

The following illustrates the effect of supply noise on the analog supply. Suppose a switching regulator with a switching frequency

of 250 kHz produces 10 mV of noise and, for simplicity's sake (ignoring harmonics), all of this noise is concentrated at 250 kHz. To calculate how much of this undesired noise appears as current noise superimposed on the DAC's full-scale current, I_{OUTFS}, users must determine the PSRR in dB using Figure 34 at 250 kHz. To calculate the PSRR for a given R_{LOAD}, such that the units of PSRR are converted from A/V to V/V, adjust the curve in Figure 34 by the scaling factor 20 Ω log (R_{LOAD}). For instance, if R_{LOAD} is 50 Ω, then the PSRR is reduced by 34 dB (that is, PSRR of the DAC at 250 kHz, which is 85 dB in Figure 34, becomes 51 dB V_{OUT}/V_{IN}).

Proper grounding and decoupling should be a primary objective in any high speed, high resolution system. The AD9740W features separate analog and digital supplies and ground pins to optimize the management of analog and digital ground currents in a system. In general, AVDD, the analog supply, should be decoupled to ACOM, the analog common, as close to the chip as physically possible. Similarly, DVDD, the digital supply, should be decoupled to DCOM as close to the chip as physically possible.

For those applications that require a single 3.3 V supply for both the analog and digital supplies, a clean analog supply can be generated using the circuit shown in Figure 35. The circuit consists of a differential LC filter with separate power supply and return lines. Lower noise can be attained by using low ESR type electrolytic and tantalum capacitors.

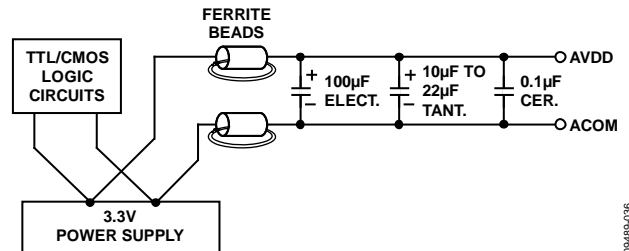
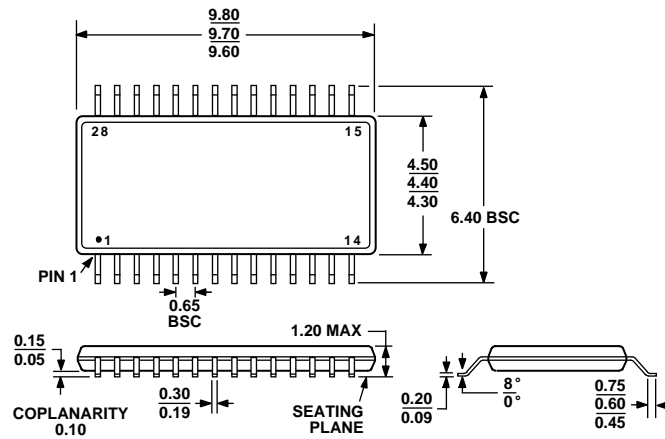

Figure 35. Differential LC Filter for Single 3.3 V Applications

OUTLINE DIMENSIONS



COMPLIANT TO JEDEC STANDARDS MO-153-AE

Figure 36. 28-Lead Thin Shrink Small Outline Package [TSSOP] (RU-28)

Dimensions shown in millimeters

ORDERING GUIDE

Model ^{1, 2}	Temperature Range	Package Description	Package Option
AD9740WARUZ	-40°C to +105°C	28-Lead TSSOP	RU-28
AD9740WARUZRL7	-40°C to +105°C	28-Lead TSSOP	RU-28

¹ Z = RoHS Compliant Part.

² W = Qualified for Automotive Applications.

AUTOMOTIVE PRODUCTS

The AD9740W models are available with controlled manufacturing to support the quality and reliability requirements of automotive applications. Note that these automotive models may have specifications that differ from the commercial models; therefore, designers should review the Specifications section of this data sheet carefully. Only the automotive grade products shown are available for use in automotive applications. Contact your local Analog Devices account representative for specific product ordering information and to obtain the specific Automotive Reliability reports for these models.

NOTES

AD9740W

NOTES

X-ON Electronics

Largest Supplier of Electrical and Electronic Components

Click to view similar products for [Digital to Analog Converters - DAC category](#):

Click to view products by [Analog Devices manufacturer](#):

Other Similar products are found below :

[5962-8871903MYA](#) [5962-8876601LA](#) [5962-89697013A](#) [5962-89932012A](#) [5962-9176404M3A](#) [PM7545FPCZ](#) [AD5311BRMZ-REEL7](#)
[AD5311RBRMZ-RL7](#) [AD558SE/883B](#) [AD5681RBCPZ-1RL7](#) [AD664TE/883B](#) [AD667SE](#) [AD7845SE/883B](#) [AD9115BCPZRL7](#)
[AD9162BBCA](#) [DAC08RC/883C](#) [JM38510/11302BEA](#) [AD5449YRUZ-REEL7](#) [AD664AJ](#) [AD664BJ](#) [AD667SE/883B](#) [AD7534JPZ](#) [TCC-](#)
[103A-RT](#) [057536E](#) [5962-87700012A](#) [5962-87700032A](#) [5962-87789022A](#) [5962-89657023A](#) [702423BB](#) [AD664BE](#) [MAX5853ETL+T](#)
[MAX5801AUB+](#) [AD9116BCPZRL7](#) [MAX5110GTJ+](#) [MAX5702BAUB+](#) [DS4412U+T&R](#) [MAX5364EUT+T](#) [MAX5858AECM+D](#)
[AD5821ABCZ-REEL7](#) [MX7528KP+](#) [MAX5858ECM+D](#) [MAX5138BGTE+T](#) [MAX5856AECM+D](#) [AD9164BBCA](#) [AD7545AUE](#)
[MX7528JP+](#) [TCC-303A-RT](#) [MAX5112GTJ+](#) [DS3911T+T](#) [MAX5805BAUB+T](#)