

LISA2-CLIP16-XP MINIATURE LENS FOR CREE XP SERIES OF LEDs

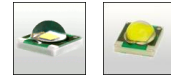

- Lens material optical grade PMMA with high UV and temperature resistance (105°C/220°F). Lens holder molded of high quality black PC (120°C/248°F).
- High optical efficiency, up to 90%. Expect Lisa2-O, around 75%.
- Integrated holder with small snap clips. See drawing below for more details. Fastening of holder the lens to PCB.
- Very small and compact dimensions: Diameter 9.9 mm, height 6.8 mm.

LENS TYPES

NAME	ORDERING CODE	FWHM Angle
Lisa2-Clip16 Real Spot	FA11085_Lisa2-RS-clip16-XP	±8°
Lisa2-Clip16 Medium	FA11075_Lisa2-M-clip16-XP	±12°
Lisa2-Clip16 Oval	FA11121_Lisa2-O-clip16-XP	±9° x ±24°
Lisa2-Clip16 Oval-90	FA11856_Lisa2-O-90-clip16-XP	±9° x ±24°
Lisa2-Clip16 Wide	FA11076_Lisa2-W-clip16-XP	±20°
Lisa2-Clip16 WW	FA11077_Lisa2-WW-clip16-XP	±30°
Lisa2-Clip16 WWW	FA11431_Lisa2-WWW-clip16-XP	~±34°

Lisa2-Clip16 Real Spot	FA11085_Lisa2-RS-clip16-XP-G	±13°
Lisa2-Clip16 Medium	FA11075_Lisa2-M-clip16-XP-G	±17°
Lisa2-Clip16 Oval	FA11121_Lisa2-O-clip16-XP-G	±12° x ±23°
Lisa2-Clip16 Oval-90	FA11856_Lisa2-O-90-clip16-XP-G	±12° x ±23°
Lisa2-Clip16 Wide	FA11076_Lisa2-W-clip16-XP-G	±20°
Lisa2-Clip16 WW	FA11077_Lisa2-WW-clip16-XP-G	~±30°
Lisa2-Clip16 WWW	FA11431_Lisa2-WWW-clip16-XP-G	~±40°

© Ledil Oy - PRELIMINARY - Subject to change without prior notice

MEASUREMENT DATA FOR CREE XP-E

Relative Intensity of FA11055_Lisa2-RS-Pin-XP

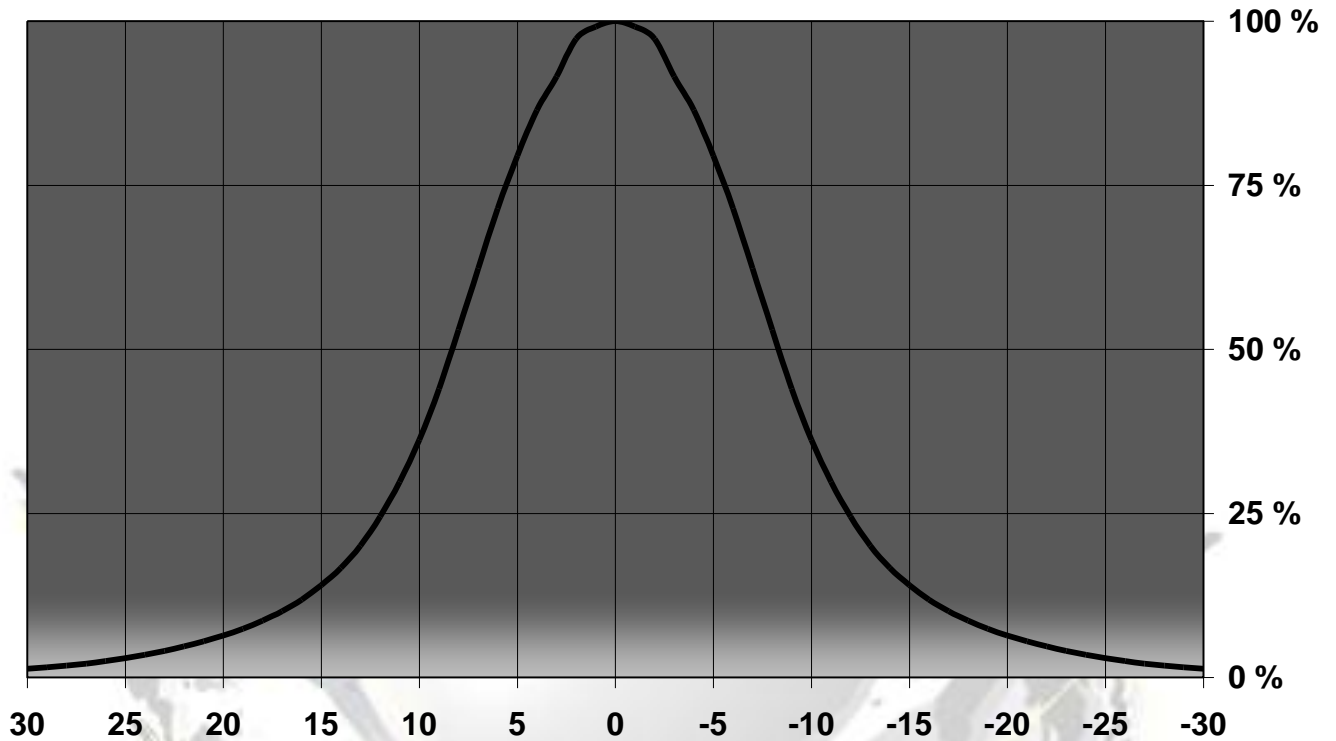

© Ledil Oy - PRELIMINARY - Subject to change without prior notice

Relative Intensity of FA10995_Lisa2-M-Pin-XP

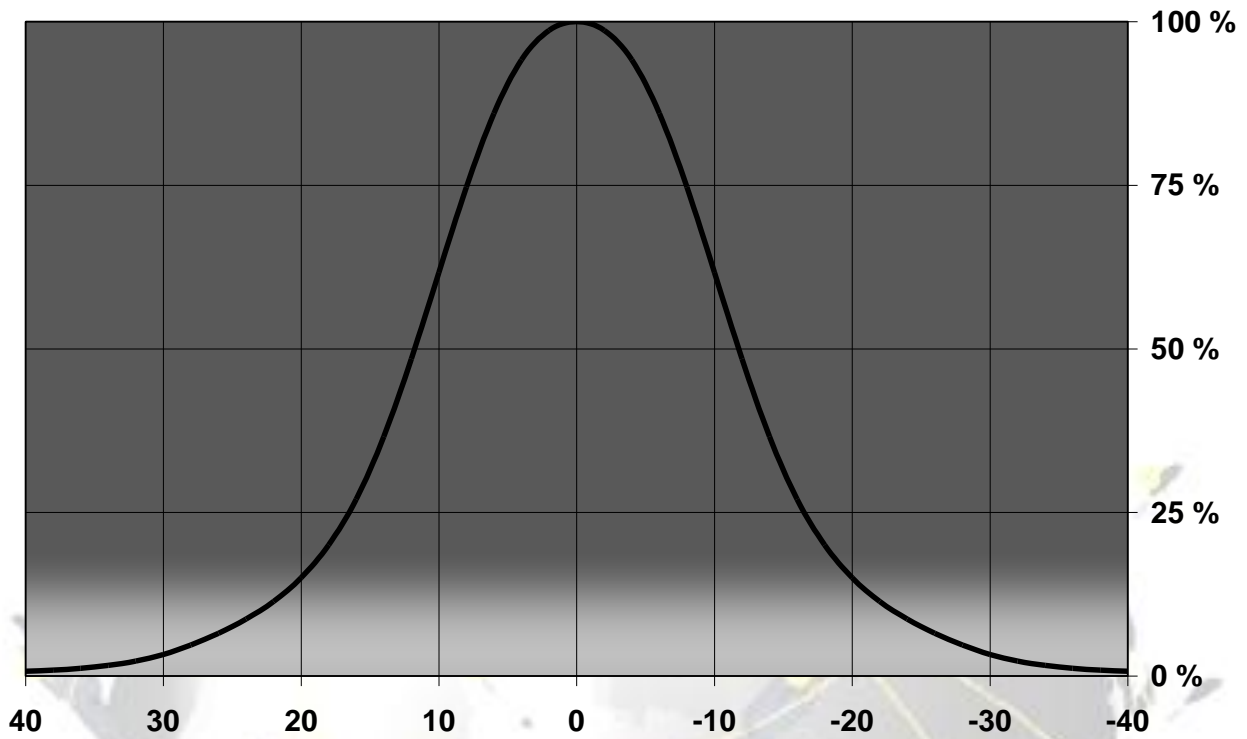

© Ledil Oy - PRELIMINARY - Subject to change without prior notice

Relative intensity of FA11125_Lisa2-O-Pin-XP

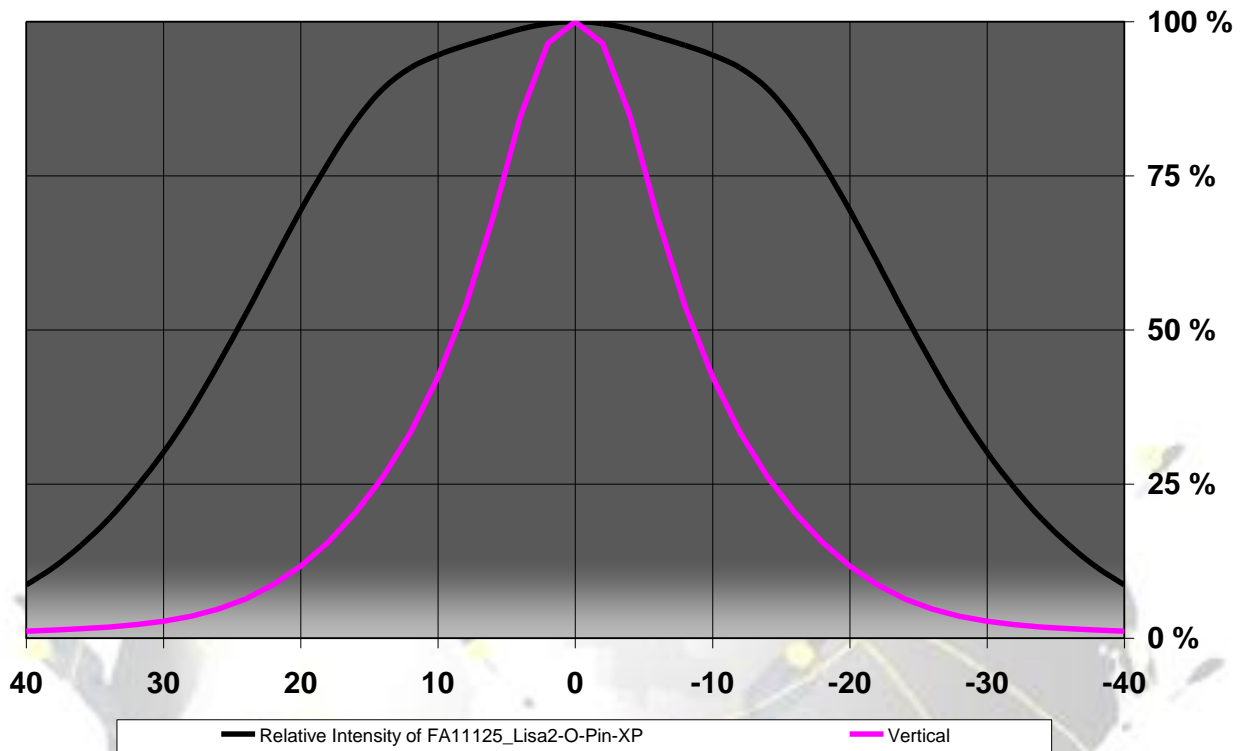

© Ledil Oy – PRELIMINARY - Subject to change without prior notice

Relative Intensity of FA10996_Lisa2-W-Pin-XP

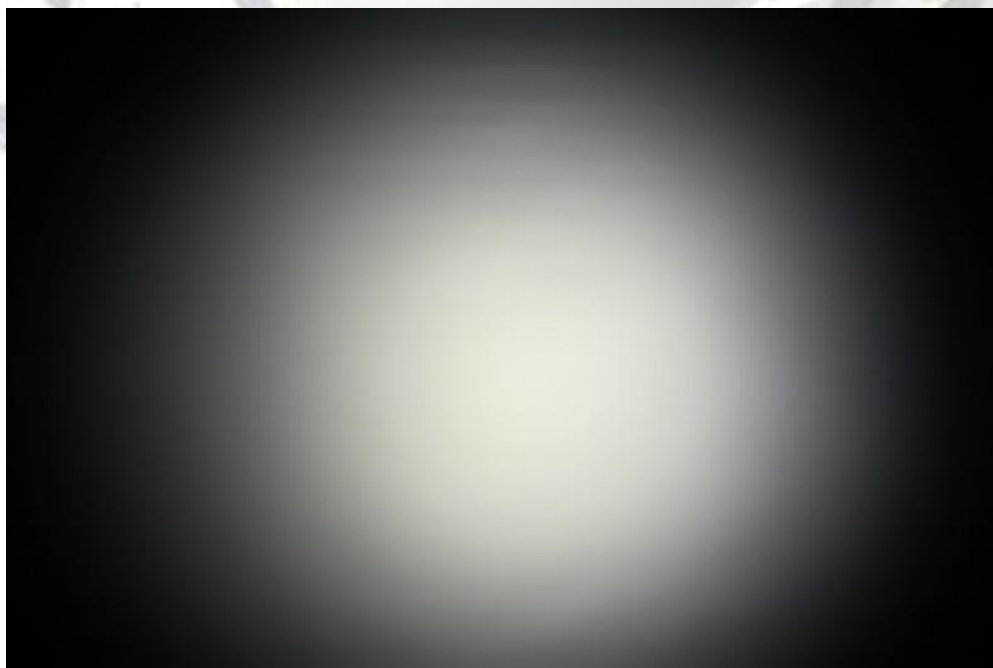
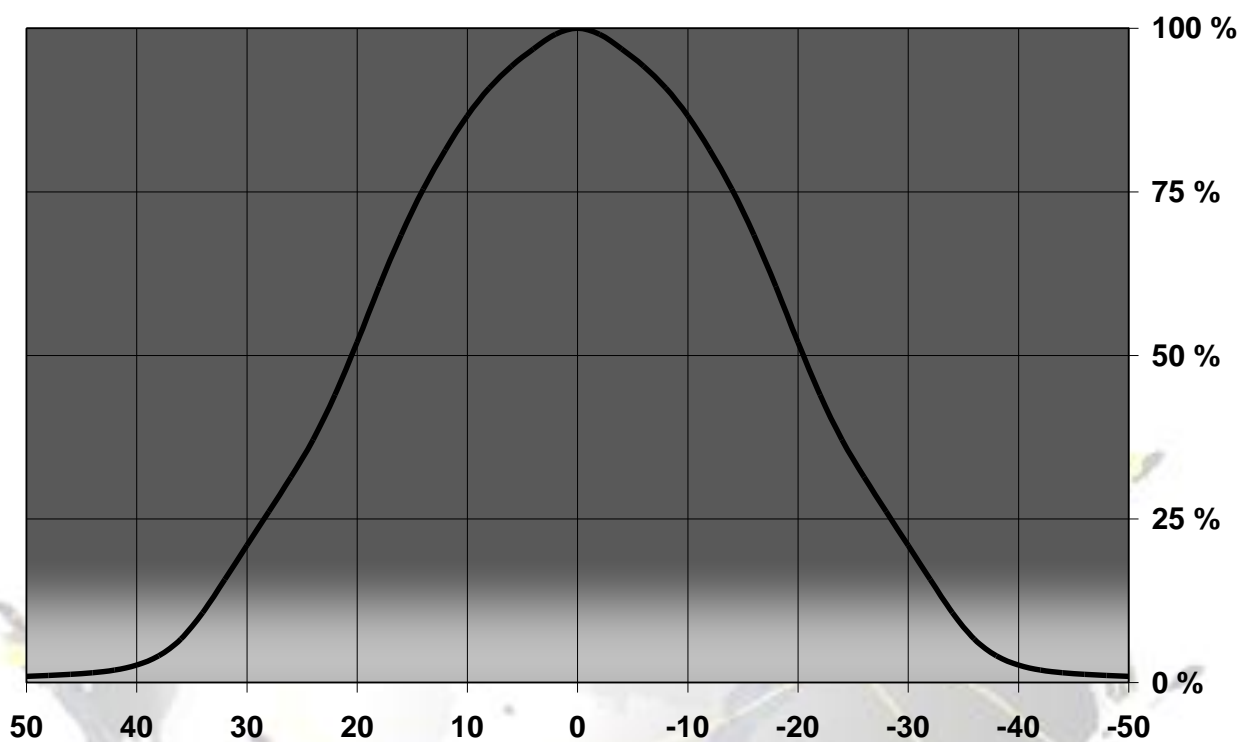

© Ledil Oy - PRELIMINARY - Subject to change without prior notice

Relative intensity of FA10997_Lisa2-WW-Pin-XP

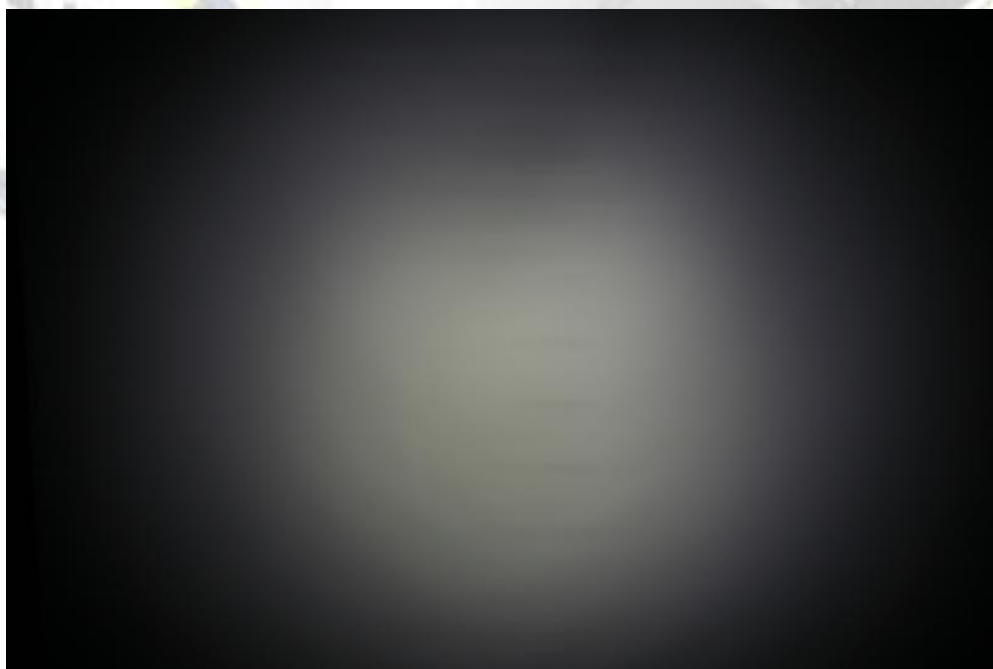
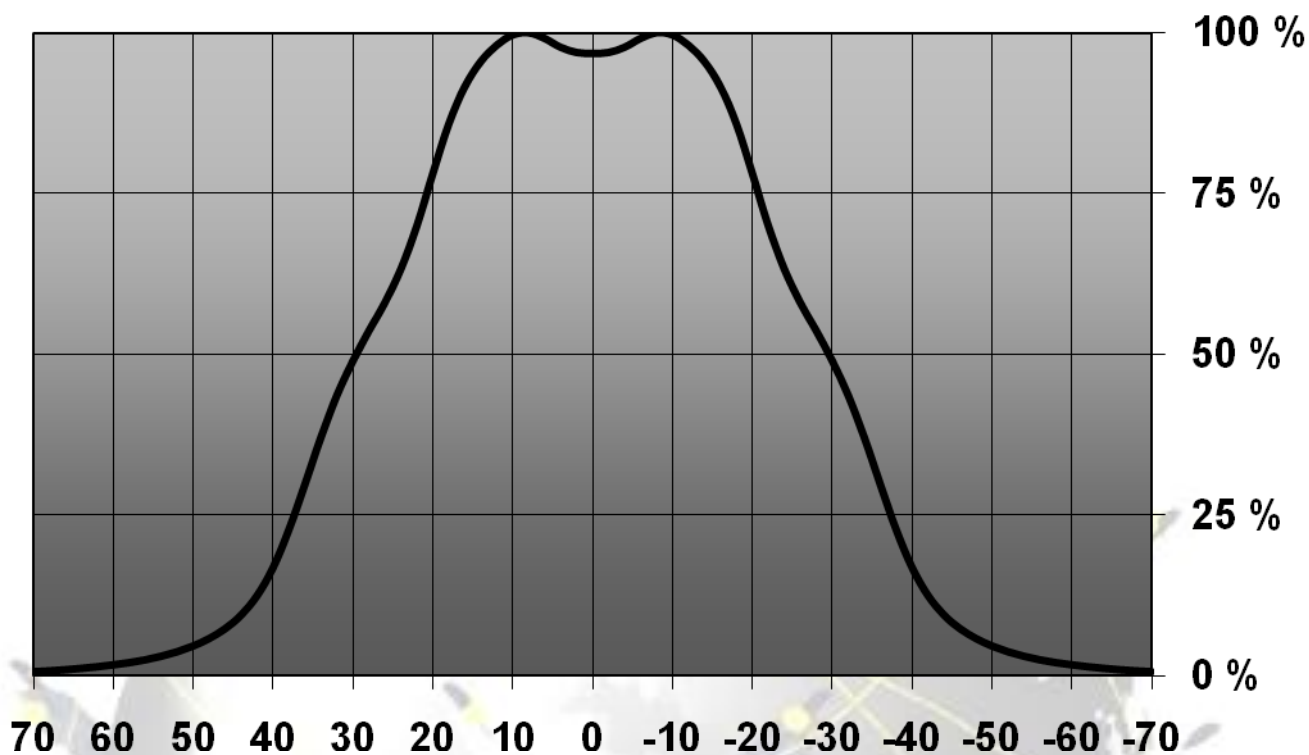

© Ledil Oy - PRELIMINARY - Subject to change without prior notice

MEASUREMENT DATA FOR CREE XP-G

Relative Intensity of FA11055_Lisa2-RS-Pin-XP-G

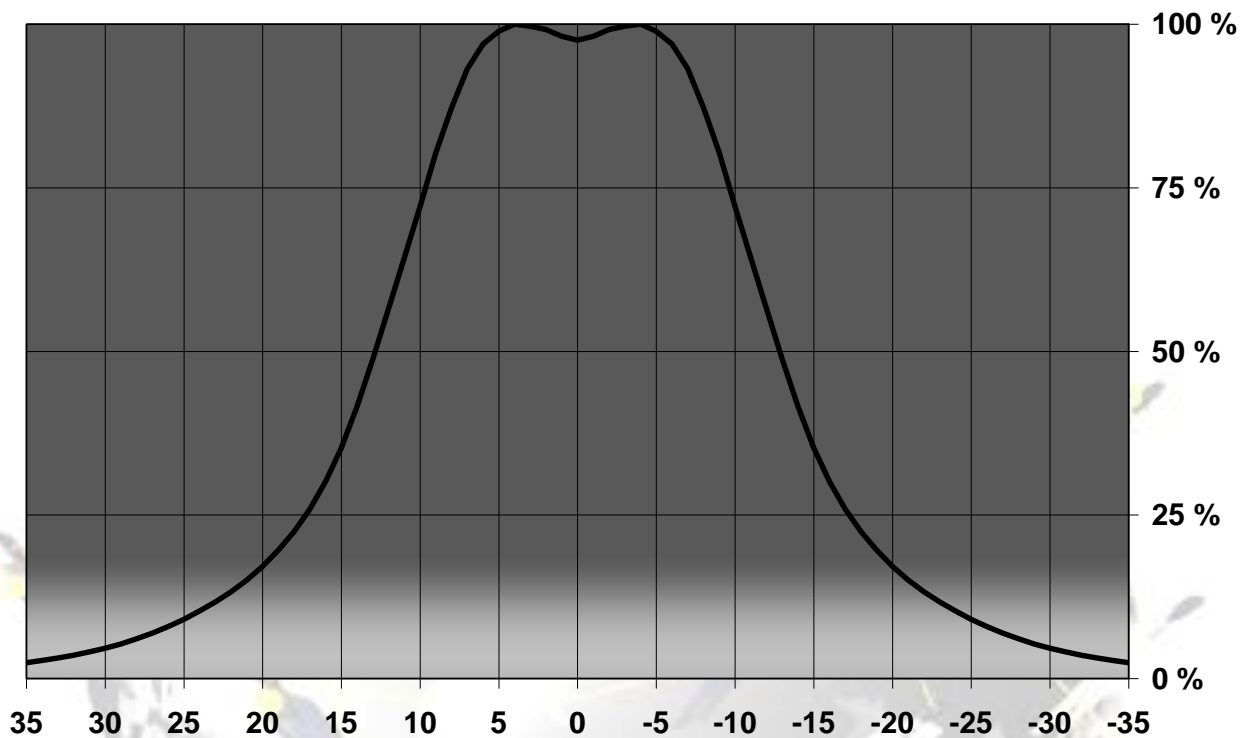

© Ledil Oy - PRELIMINARY - Subject to change without prior notice

Relative Intensity of FA10995_Lisa2-M-Pin-XP-G

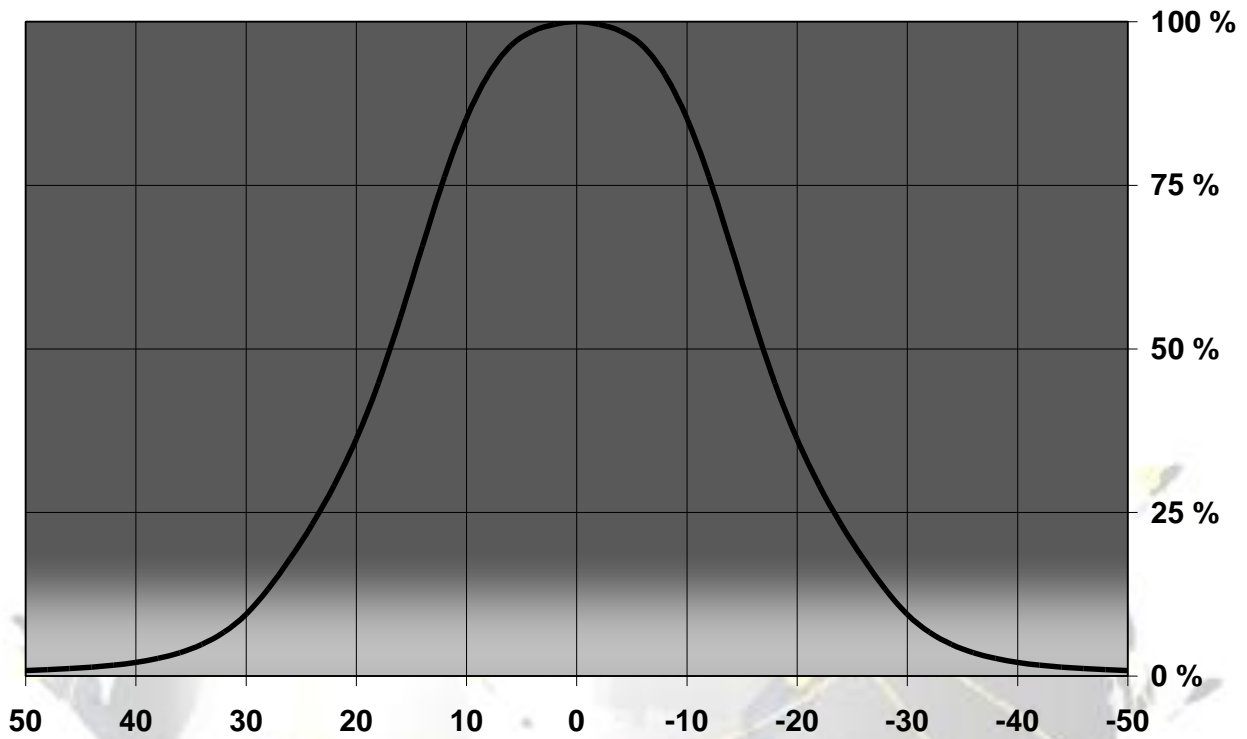

© Ledil Oy - PRELIMINARY - Subject to change without prior notice

Relative intensity of FA11125_Lisa2-O-Pin-XP-G

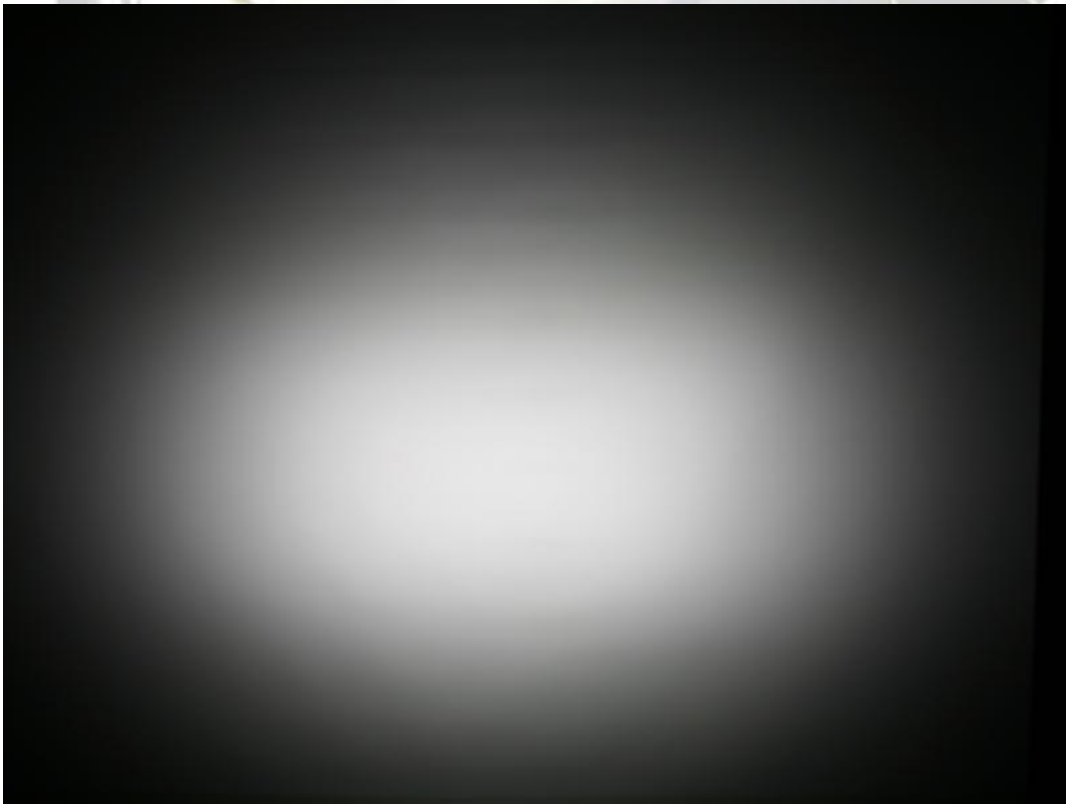
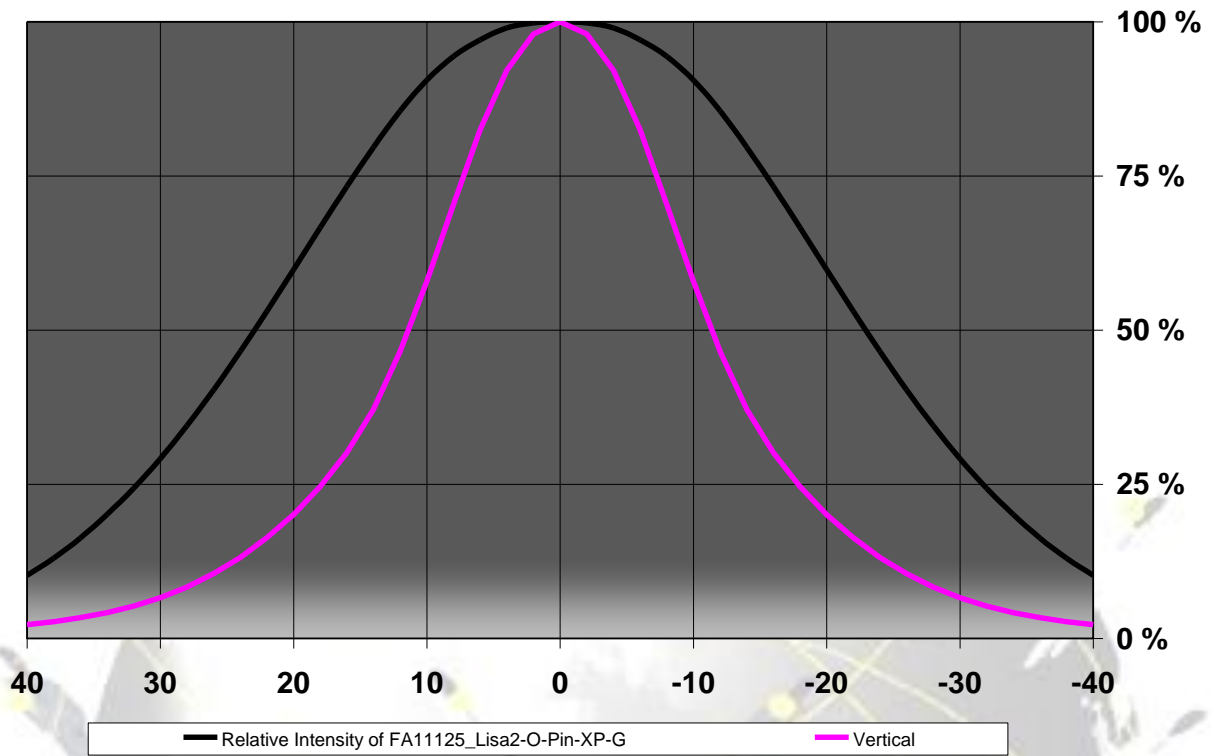

© Ledil Oy - PRELIMINARY - Subject to change without prior notice

Relative Intensity of FA10996_Lisa2-W-Pin-XP-G

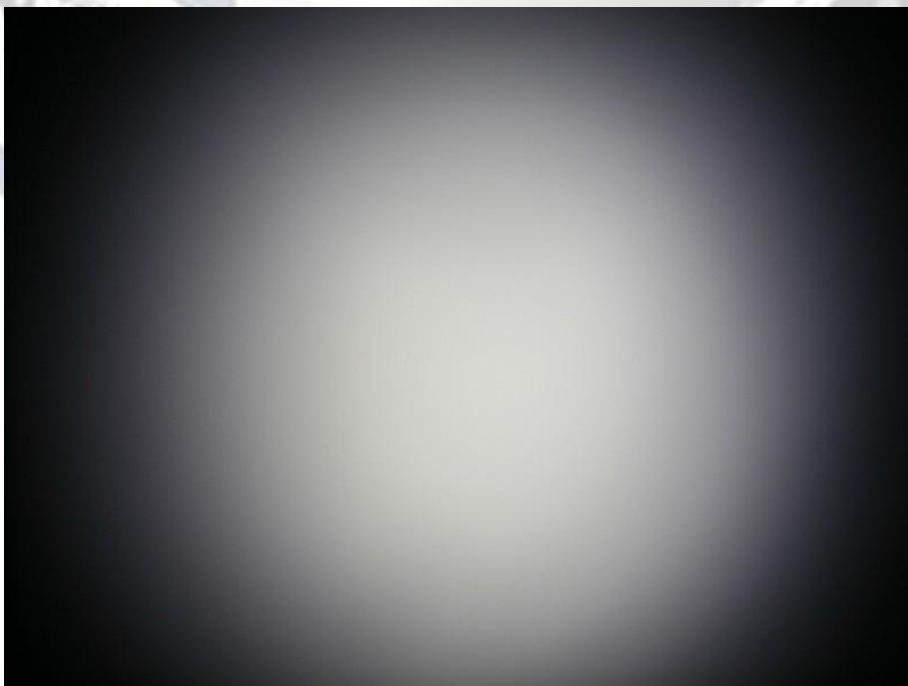
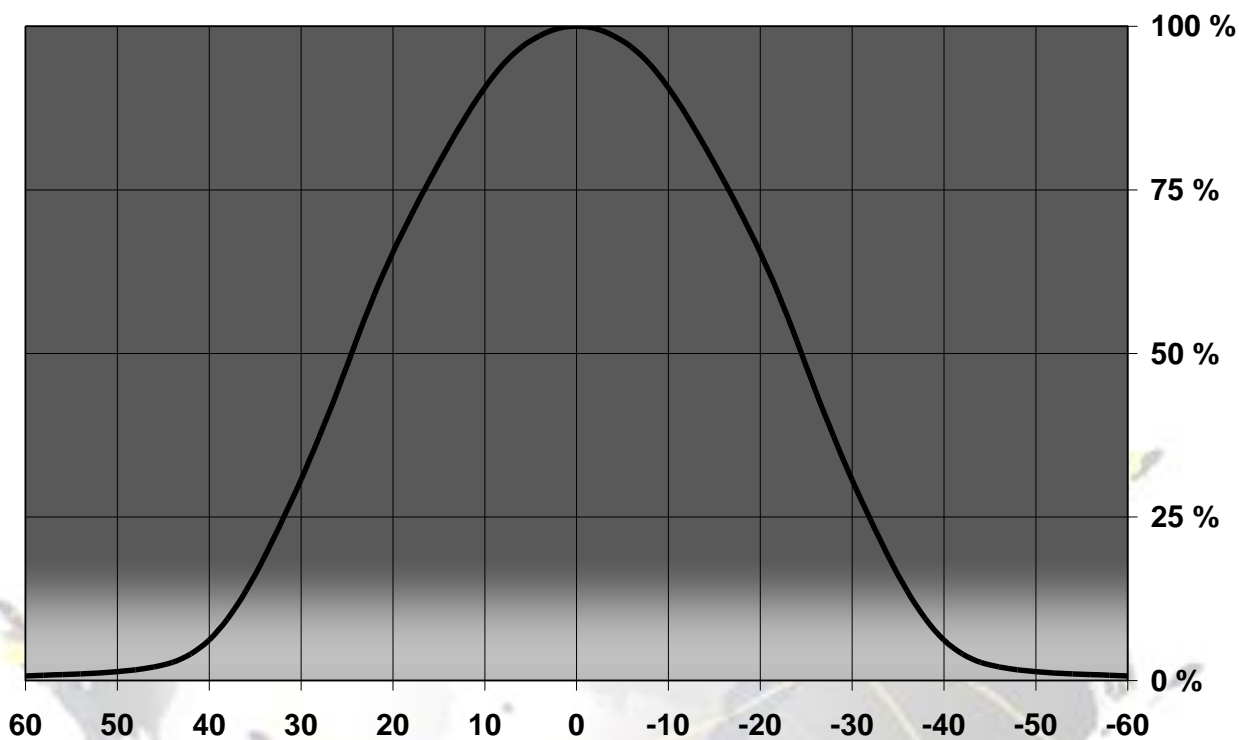

© Ledil Oy - PRELIMINARY - Subject to change without prior notice

Relative intensity of FA10997_Lisa2-WW-Pin-XP-G

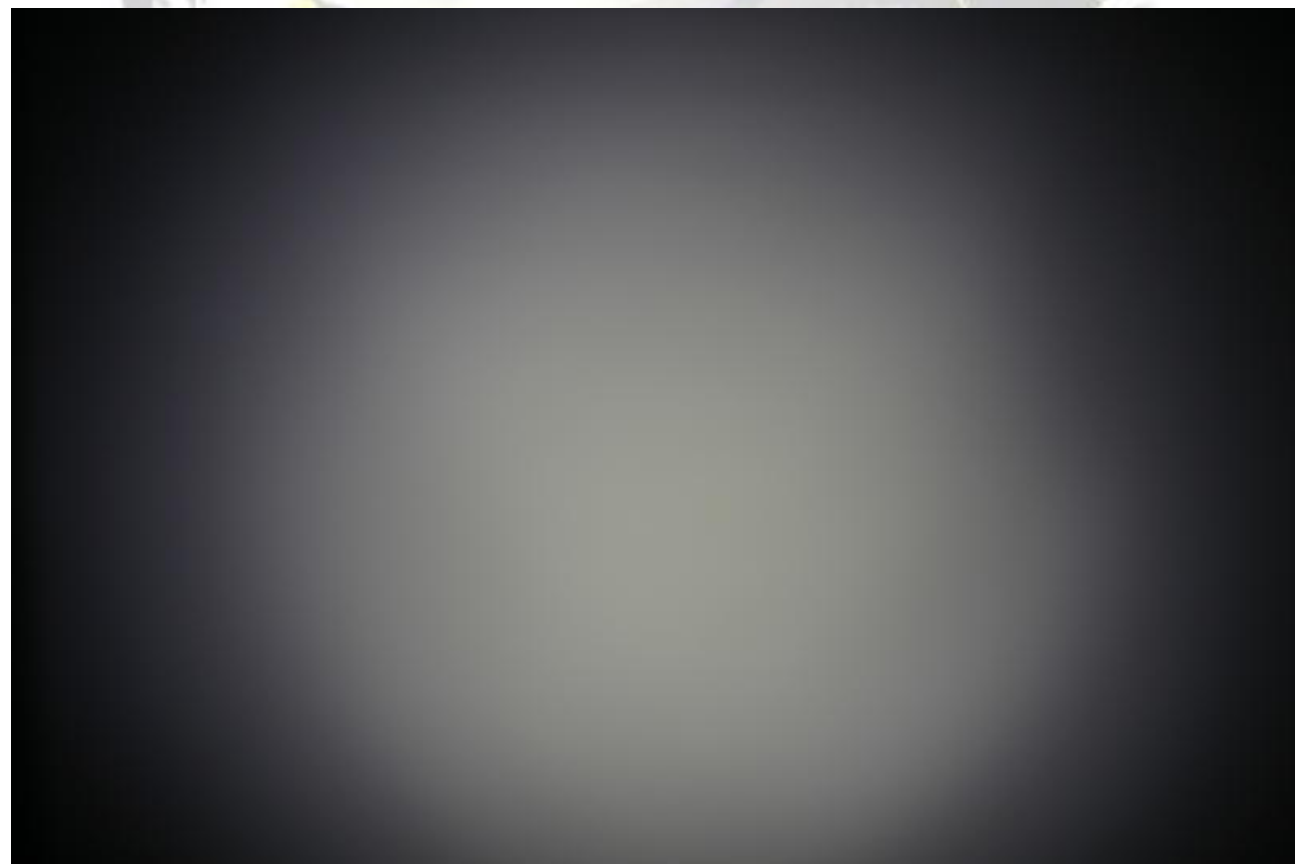
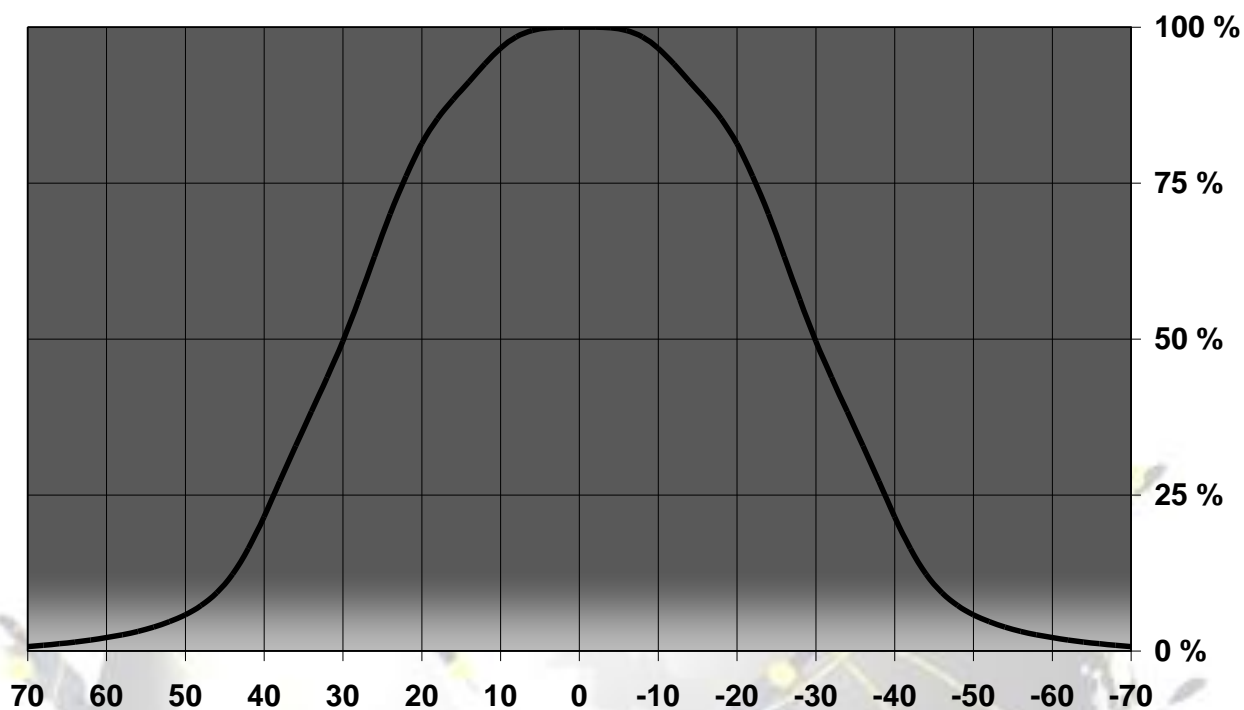

© Ledil Oy – PRELIMINARY - Subject to change without prior notice

DRAWINGS

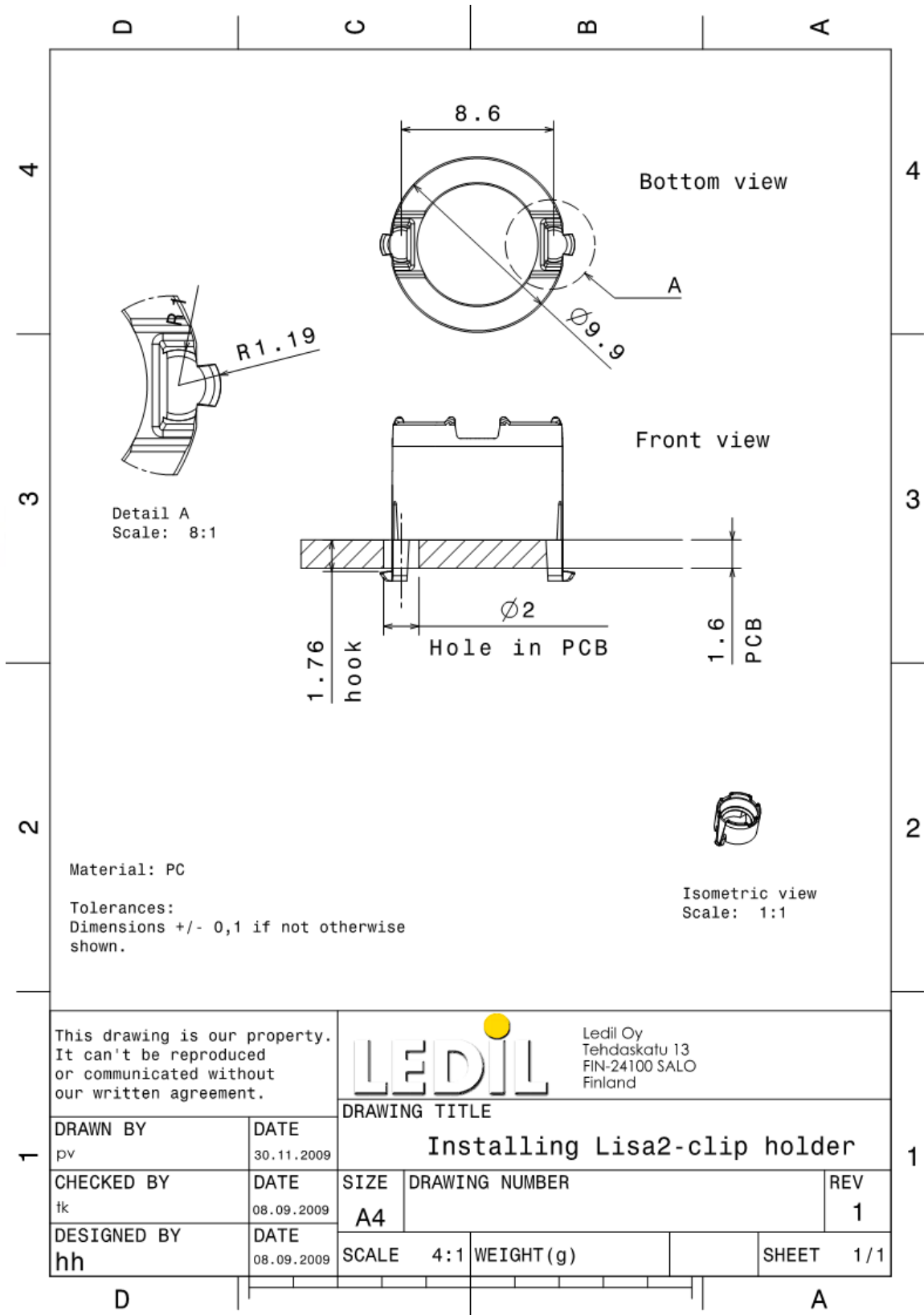

© Ledil Oy - PRELIMINARY - Subject to change without prior notice

X-ON Electronics

Largest Supplier of Electrical and Electronic Components

Click to view similar products for [LED Lenses](#) category:

Click to view products by [Ledil](#) manufacturer:

Other Similar products are found below :

[131A-303G](#) [131A-304R](#) [139A-403R](#) [139A-403A](#) [160A-604R](#) [160A-604Y](#) [SMB_200_GTP](#) [SMQ_250_ATP](#) [SMS_172_RTP](#) [SQB_400_ATP](#)
[SSN-LX13049L-CD](#) [SSN-LX18754A](#) [SSN-LX18754C](#) [2817](#) [CLR_301_YTP](#) [CMC_313_ATP](#) [3121](#) [3124](#) [3125](#) [39-30-W03](#) [4623](#) [4745](#)
[4747](#) [3111](#) [3114](#) [3115](#) [3121](#) [3122](#) [3124](#) [3125](#) [4327](#) [4743](#) [4745](#) [4752](#) [4757](#) [SSN-LX690L1-C](#) [SQL_360_YTP](#) [SMQ_250_BTP](#) [3114](#) [3113](#)
[CMS444CTP](#) [1125-227-000](#) [4317](#) [4347](#) [4741](#) [4316](#) [4343](#) [4345](#) [4345](#) [4346](#)