

Spezifikation für Freigabe / specification for release

Kunde / customer :

Artikelnummer / part number : **744318270**

LF



Bezeichnung : **SMD HOCHSTROMINDUKTIVITÄT WE-HC**

description : **SMD POWER CHOKE WE-HC**

WÜRTH ELEKTRONIK

DATUM / DATE : 2007-11-01

A Mechanische Abmessungen / dimensions :

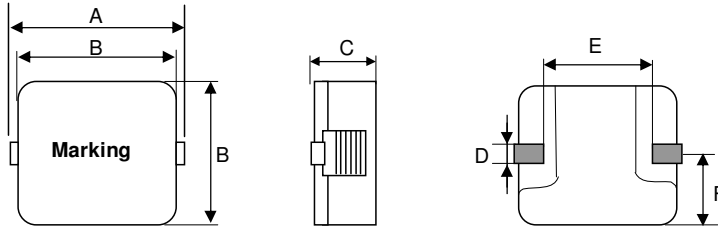

A	13,5 ± 0,4	mm
B	12,8 ± 0,3	mm
C	4,9 ± 0,3	mm
D	2,3 ± 0,2	mm
E	8,0 ± 0,8	mm
F	6,4 ± 0,3	mm
G		mm
H		mm

B Elektrische Eigenschaften / electrical properties :

Eigenschaften / properties	Testbedingungen / test conditions		Wert / value	Einheit / unit	tol.
Induktivität / inductance	100 kHz / 0,1V	L_o	2,70	μ H	$\pm 20\%$
Nenn-Induktivität / rated inductance	100 kHz / 0,1V / 16A	L_N	2,15	μ H	$\pm 20\%$
DC-Widerstand / DC-resistance	@ 20° C	R_{DC}	4,00	m Ω	$\pm 8\%$
Nennstrom / rated current	$\Delta T = 50 K$	I_{DC}	16,0	A	typ.
Sättigungsstrom / saturation current	$\Delta L/L_o = -30\%$	I_{sat}	20,0	A	typ.
Eigenres.-Frequenz / self.res.-frequency		SRF	39,0	MHz	ref.

C Lötpad / soldering spec. :

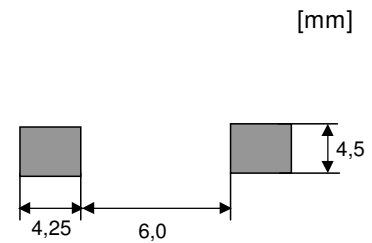

D Prüfgeräte / test equipment :

HP 4274 A für/for L und/and Q
HP 34401 A für/for I_{DC} und/and R_{DC}

E Testbedingungen / test conditions :

Luftfeuchtigkeit / humidity: 33%
 Umgebungstemperatur / temperature: + 25°C

F Werkstoffe & Zulassungen / material & approvals :

Kernmaterial / core material: WE-Superflux 200
 Draht / wire: Flatwire/ Flachdraht UL94-V0; 2UEWF 155°C

G Eigenschaften / granted properties :

Arbeitstemperatur / operating temperature: -40°C - +150°C
 Umgebungstemp. / ambient temperature: -40°C - +100°C
 It is recommended that the temperature of the part does not exceed 150°C under worst case operating conditions.

Freigabe erteilt / general release:	Kunde / customer		
	ME	Version 7	2007-11-01
Datum / date	Unterschrift / signature		
	ME	Version 6	2005-04-18
Geprüft / checked	Würth Elektronik		
	MST	Version 5	2004-11-09
Kontrolliert / approved	MST	Version 4	2004-10-11
	SST	Version 3	2004-01-27
Name	AG	Version 2	2003-06-11
	JH	Neugestaltung	2000-12-06
Änderung / modification		Datum / date	

Würth Elektronik eiSos GmbH & Co. KG

D-74638 Waldenburg · Max-Eyth-Strasse 1 - 3 · Germany · Telefon (+49) (0) 7942 - 945 - 0 · Telefax (+49) (0) 7942 - 945 - 400
<http://www.we-online.com>

Spezifikation für Freigabe / specification for release

Kunde / customer :

Artikelnummer / part number : **744318270**

LF



Bezeichnung : **SMD HOCHSTROMINDUKTIVITÄT WE-HC**

description : **SMD POWER CHOKE WE-HC**

WÜRTH ELEKTRONIK

DATUM / DATE : 2007-11-01

H Induktivitätskurve / Inductance curve :

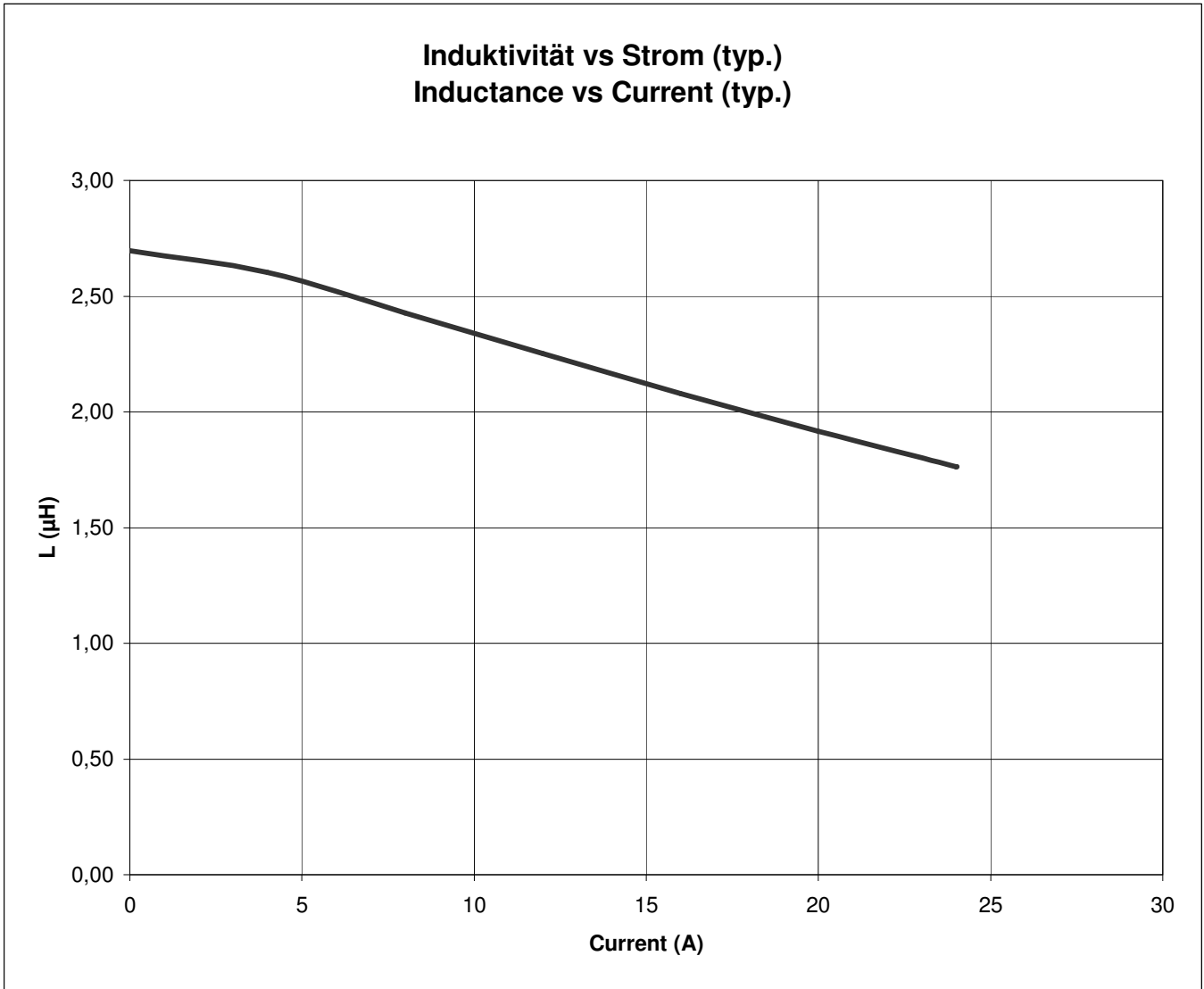

Freigabe erteilt / general release:	Kunde / customer			
Datum / date	Unterschrift / signature			
Geprüft / checked	Kontrolliert / approved			
		Würth Elektronik		
		Würth Elektronik eiSos GmbH & Co. KG		
		D-74638 Waldenburg · Max-Eyth-Strasse 1 - 3 · Germany · Telefon (+49) (0) 7942 - 945 - 0 · Telefax (+49) (0) 7942 - 945 - 400 http://www.we-online.com		

Name	Änderung / modification	Datum / date
ME	Version 7	2007-11-01
ME	Version 6	2005-04-18
MST	Version 5	2004-11-09
MST	Version 4	2004-10-11
SST	Version 3	2004-01-27
AG	Version 2	2003-06-11
JH	Neugestaltung	2000-12-06

Spezifikation für Freigabe / specification for release

Kunde / customer :

Artikelnummer / part number :

744318270

LF



Bezeichnung :

description :

I Temperaturanstieg / Temperature rise curve :

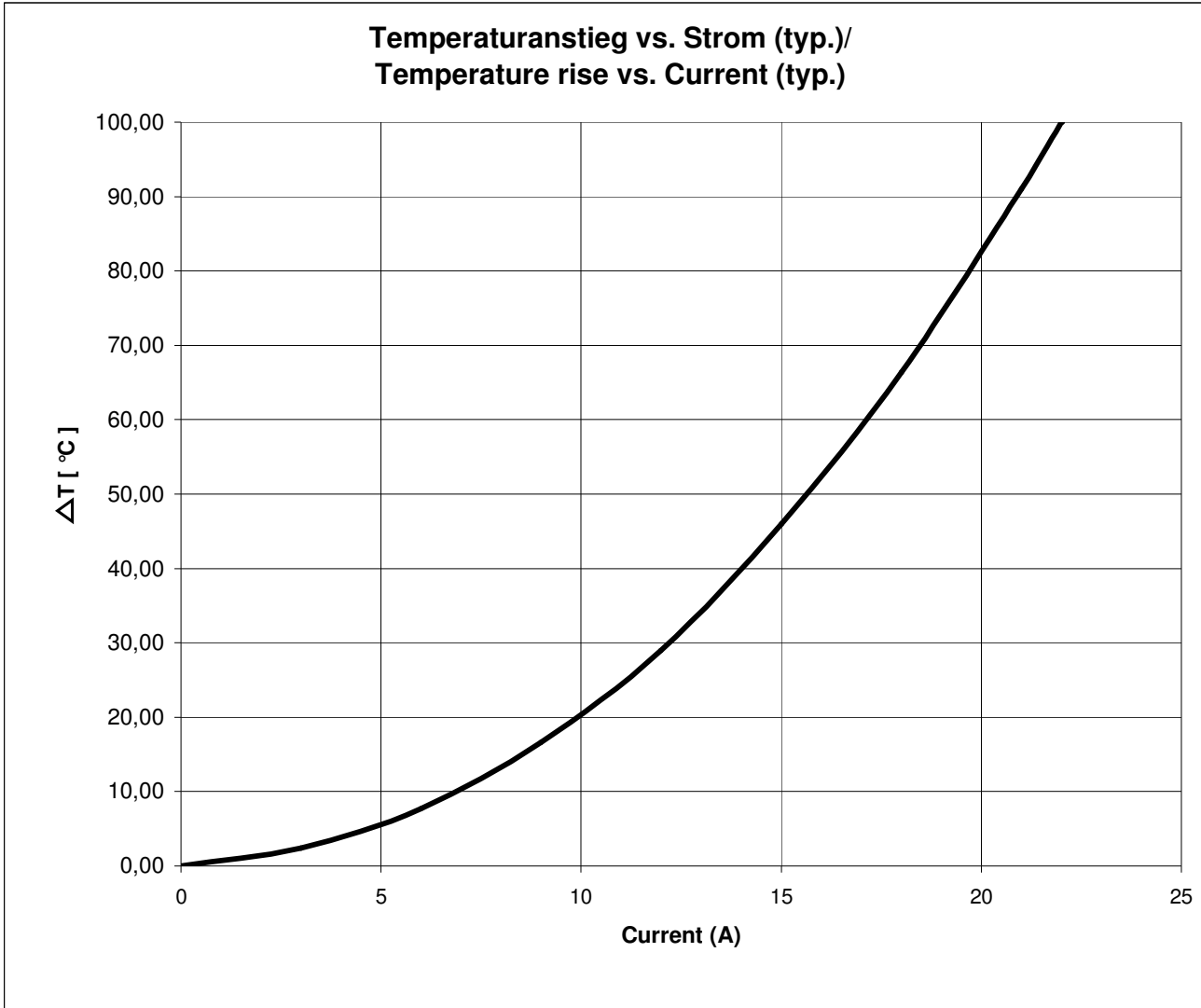

Freigabe erteilt / general release:	Kunde / customer			
Datum / date	Unterschrift / signature	Name	Änderung / modification	Datum / date
Geprüft / checked	Kontrolliert / approved	SST	Version 3	2004-01-27
	Würth Elektronik	AG	Version 2	2003-06-11
		JH	Neugestaltung	2000-12-06

Würth Elektronik eiSos GmbH & Co. KG

D-74638 Waldenburg · Max-Eyth-Strasse 1 - 3 · Germany · Telefon (+49) (0) 7942 - 945 - 0 · Telefax (+49) (0) 7942 - 945 - 400
<http://www.we-online.com>

Spezifikation für Freigabe / specification for release

Kunde / customer :

Artikelnummer / part number : **744318270**

LF



Bezeichnung : **SMD HOCHSTROMINDUKTIVITÄT WE-HC**

description : **SMD POWER CHOKE WE-HC**

DATUM / DATE : 2007-11-01

J Rollenspezifikation / tape and reel specification :

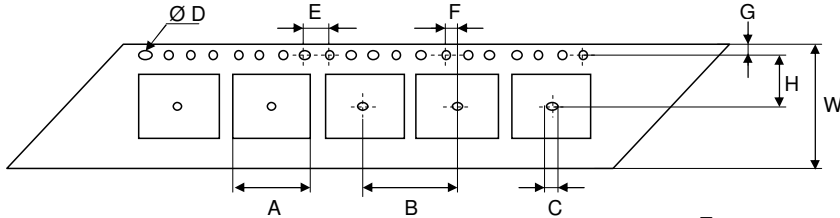

Gurtspezifikation / Tape specification:		
A	13,1 ± 0,1	mm
B	16,0 ± 0,1	mm
C	1,50 ± 0,05	mm
D	1,50 ± 0,05	mm
E	4,00 ± 0,1	mm
F	2,00 ± 0,1	mm
G	1,75 ± 0,1	mm
H	11,5 ± 0,1	mm
I	13,1 ± 0,1	mm
J	5,60 ± 0,1	mm
T	0,35 ± 0,05	mm
W	24,0 ± 0,3	mm

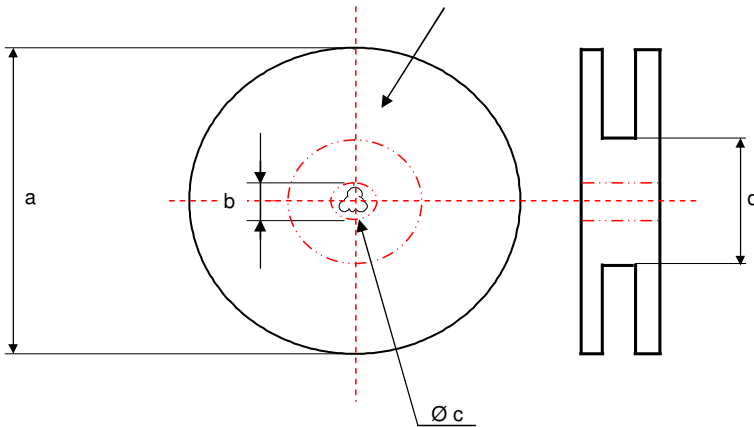
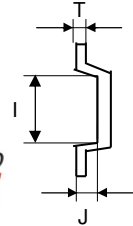

Rollenspezifikation / Reel specification:		
a	330,0 ± 0,5	mm
b	20,20 ± 0,1	mm
c	13,00^{+0,5}_{-1,0}	mm
d	100,0 ± 1,0	mm

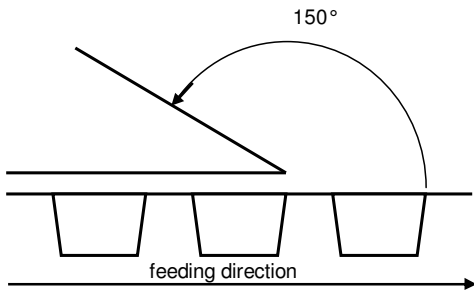

The Force for tearing off cover tape is 20 to 70 grams in arrow direction

Freigabe erteilt / general release:	Kunde / customer		
		ME	Version 7
Datum / date	Unterschrift / signature	ME	Version 6 05-04-18
	Würth Elektronik	MST	Version 5 04-11-09
Geprüft / checked	Kontrolliert / approved	MST	Version 4 04-10-11
		SST	Version 3 04-01-27
		AG	Version 2 03-06-11
		JH	Neugestaltung 00-12-06
		Name	Änderung / modification Datum / date

This electronic component has been designed and developed for usage in general electronic equipment. Before incorporating this component into any equipment where higher safety and reliability is especially required or if there is the possibility of direct damage or injury to human body, for example in the range of aerospace, aviation, nuclear control, submarine, transportation, (automotive control, train control, ship control), transportation signal, disaster prevention, medical, public information network etc, Würth Elektronik eiSos GmbH must be informed before the design-in stage. In addition, sufficient reliability evaluation checks for safety must be performed on every electronic component which is used in electrical circuits that require high safety and reliability functions or performance.

Würth Elektronik eiSos GmbH & Co. KG

D-74638 Waldenburg · Max-Eyth-Strasse 1 - 3 · Germany · Telefon (+49) (0) 7942 - 945 - 0 · Telefax (+49) (0) 7942 - 945 - 400
<http://www.we-online.com>

X-ON Electronics

Largest Supplier of Electrical and Electronic Components

Click to view similar products for [wurth manufacturer](#):

Other Similar products are found below :

[687001](#) [744741101](#) [750341638](#) [31402](#) [61801525023](#) [686626050001](#) [744741471](#) [744772681](#) [744777](#) [749119950](#) [750312504](#) [890334025009](#)
[IC-744885](#) [875115350002](#) [600690282801](#) [178050601](#) [615008138221](#) [750311898](#) [744999](#) [7446823003](#) [7446323004](#) [744028](#) [66201621822](#)
[7446221012](#) [744720](#) [760895431](#) [760895651](#) [662006236022](#) [64900621822](#) [418117270910](#) [890334026014](#) [744839208072](#) [744762A/RFI](#)
[74651174R](#) [744838180160](#) [885300](#) [750310346](#) [861011384014](#) [750817018](#) [33008](#) [3020903](#) [885342](#) [2603019321001](#) [2603019021001](#)
[2606039021001](#) [2608019324001](#) [2607019213001](#) [2605039241001](#) [2605049281001](#) [2607029291011](#)