



ON Semiconductor®

# ON Semiconductor DATA SHEET

## MCH3333 — P-Channel Silicon MOSFET General-Purpose Switching Device Applications

### Features

- Low ON-resistance.
- Ultrahigh-speed switching.
- 2.5V drive.

### Specifications

**Absolute Maximum Ratings** at  $T_a=25^\circ\text{C}$

| Parameter                   | Symbol    | Conditions   | Ratings     | Unit             |
|-----------------------------|-----------|--|-------------|------------------|
| Drain-to-Source Voltage     | $V_{DS}$  |  | -30         | V                |
| Gate-to-Source Voltage      | $V_{GS}$  |  | $\pm 10$    | V                |
| Drain Current (DC)          | $I_D$     |  | -1.5        | A                |
| Drain Current (Pulse)       | $I_{DP}$  | $PW \leq 10\mu\text{s}$ , duty cycle $\leq 1\%$        | -6.0        | A                |
| Allowable Power Dissipation | $P_D$     | Mounted on a ceramic board (900mm <sup>2</sup> ×0.8mm) | 0.9         | W                |
| Channel Temperature         | $T_{ch}$  |  | 150         | $^\circ\text{C}$ |
| Storage Temperature         | $T_{stg}$ |  | -55 to +150 | $^\circ\text{C}$ |

**Electrical Characteristics** at  $T_a=25^\circ\text{C}$

| Parameter                                  | Symbol        | Conditions                                 | Ratings |     |          | Unit             |
|--|---------------|--|---------|-----|----------|------------------|
|  |               |  | min     | typ | max      |                  |
| Drain-to-Source Breakdown Voltage          | $V_{(BR)DSS}$ | $I_D=-1\text{mA}$ , $V_{GS}=0$             | -30     |     |          | V                |
| Zero-Gate Voltage Drain Current            | $I_{DSS}$     | $V_{DS}=-30\text{V}$ , $V_{GS}=0$          |         |     | -1       | $\mu\text{A}$    |
| Gate-to-Source Leakage Current             | $I_{GSS}$     | $V_{GS}=\pm 8\text{V}$ , $V_{DS}=0$        |         |     | $\pm 10$ | $\mu\text{A}$    |
| Cutoff Voltage                             | $V_{GS(off)}$ | $V_{DS}=-10\text{V}$ , $I_D=-1\text{mA}$   | -0.4    |     | -1.4     | V                |
| Forward Transfer Admittance                | $ y_{fs} $    | $V_{DS}=-10\text{V}$ , $I_D=-0.8\text{A}$  | 1.38    | 2.3 |          | S                |
| Static Drain-to-Source On-State Resistance | $R_{DS(on)1}$ | $I_D=-0.8\text{A}$ , $V_{GS}=-4\text{V}$   |         | 215 | 280      | $\text{m}\Omega$ |
|  | $R_{DS(on)2}$ | $I_D=-0.4\text{A}$ , $V_{GS}=-2.5\text{V}$ |         | 290 | 410      | $\text{m}\Omega$ |
| Input Capacitance                          | $C_{iss}$     | $V_{DS}=-10\text{V}$ , $f=1\text{MHz}$     |         | 285 |          | pF               |
| Output Capacitance                         | $C_{oss}$     | $V_{DS}=-10\text{V}$ , $f=1\text{MHz}$     |         | 52  |          | pF               |
| Reverse Transfer Capacitance               | $C_{rss}$     | $V_{DS}=-10\text{V}$ , $f=1\text{MHz}$     |         | 38  |          | pF               |
| Turn-ON Delay Time                         | $t_{d(on)}$   | See specified Test Circuit.                |         | 10  |          | ns               |
| Rise Time                                  | $t_r$         | See specified Test Circuit.                |         | 21  |          | ns               |
| Turn-OFF Delay Time                        | $t_{d(off)}$  | See specified Test Circuit.                |         | 35  |          | ns               |
| Fall Time                                  | $t_f$         | See specified Test Circuit.                |         | 28  |          | ns               |

Marking : YJ

Continued on next page.

# MCH3333

Continued from preceding page.

| Parameter                     | Symbol | Conditions                           | Ratings |       |      | Unit |
|-------------------------------|--------|--------------------------------------|---------|-------|------|------|
|                               |        |                                      | min     | typ   | max  |      |
| Total Gate Charge             | Qg     | $V_{DS}=-10V, V_{GS}=-4V, I_D=-1.5A$ |         | 2.6   |      | nC   |
| Gate-to-Source Charge         | Qgs    | $V_{DS}=-10V, V_{GS}=-4V, I_D=-1.5A$ |         | 0.78  |      | nC   |
| Gate-to-Drain "Miller" Charge | Qgd    | $V_{DS}=-10V, V_{GS}=-4V, I_D=-1.5A$ |         | 0.64  |      | nC   |
| Diode Forward Voltage         | VSD    | $I_S=-1.5A, V_{GS}=0$                |         | -0.89 | -1.5 | V    |

## Package Dimensions

unit : mm

2167A

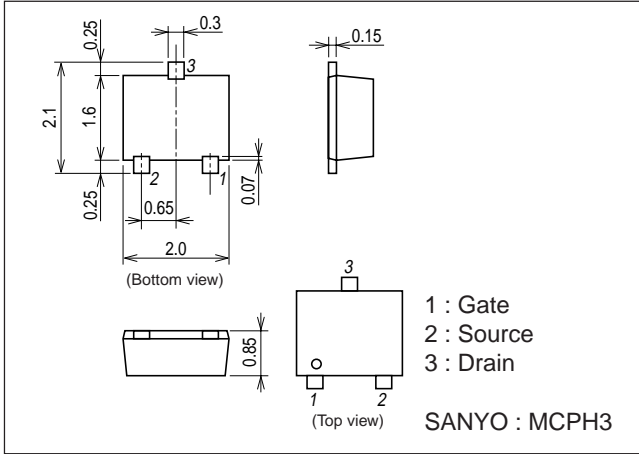

## Switching Time Test Circuit

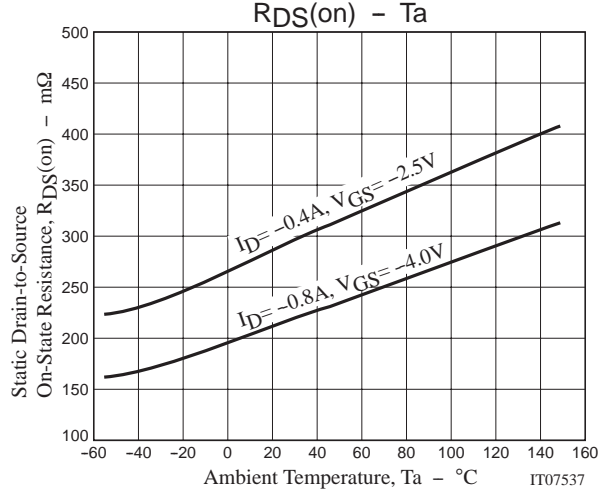
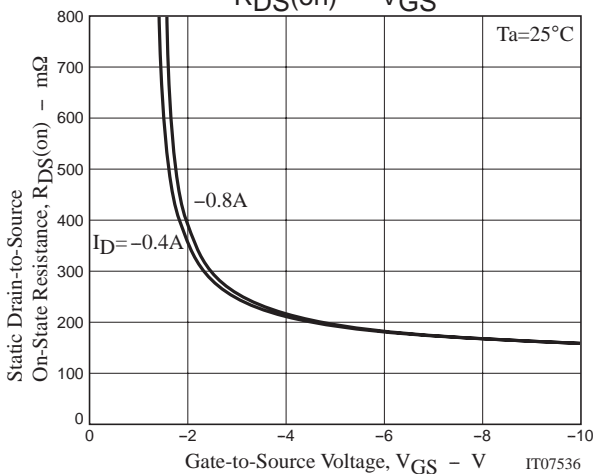
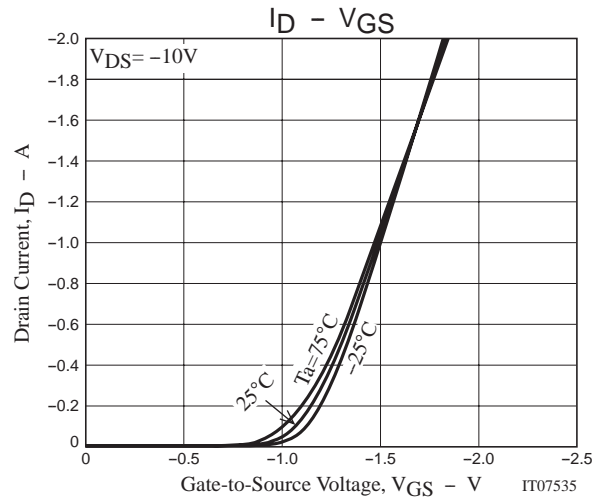
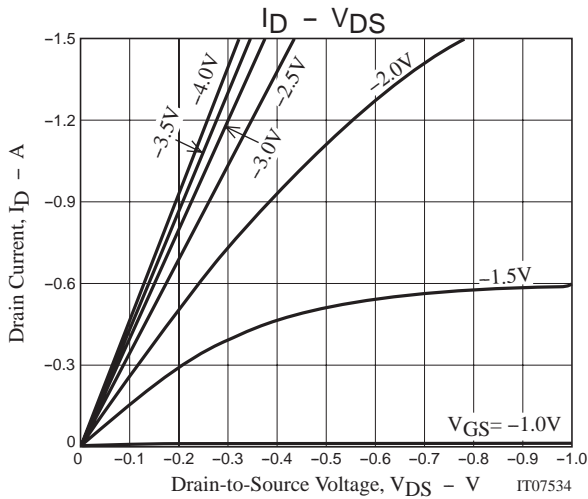
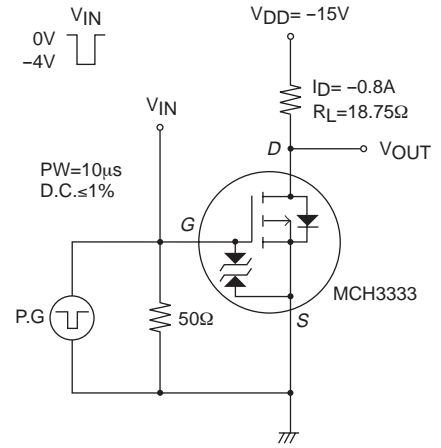

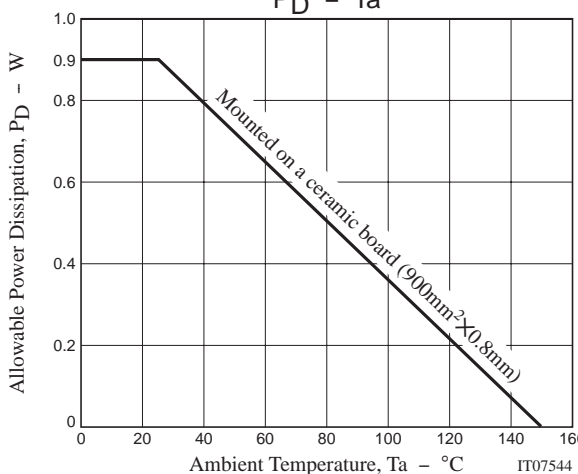
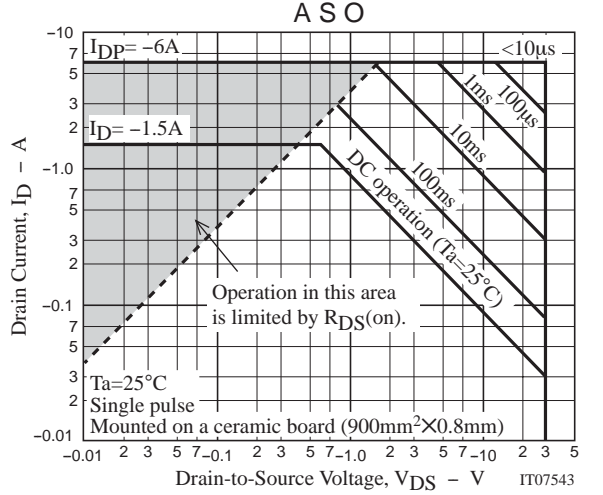
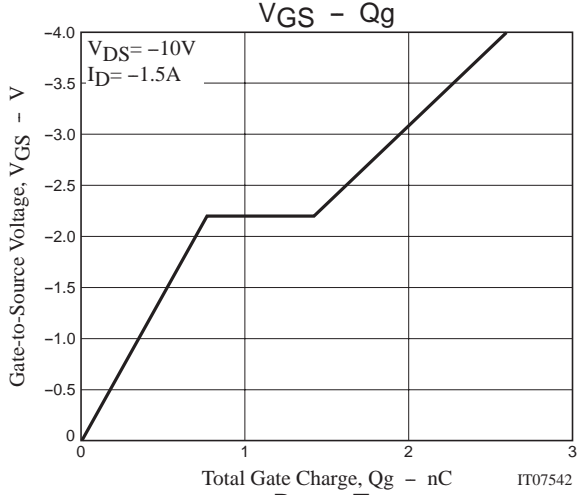
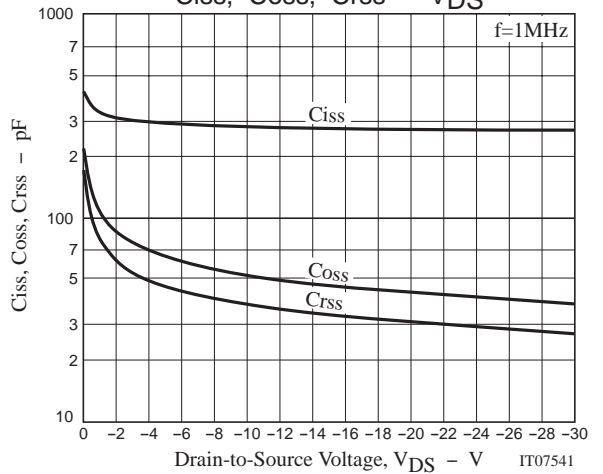
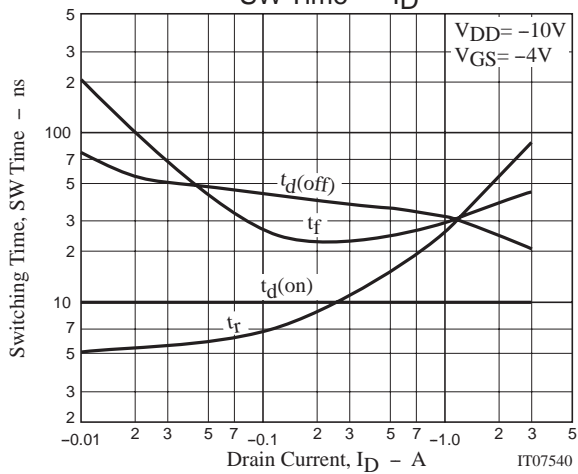
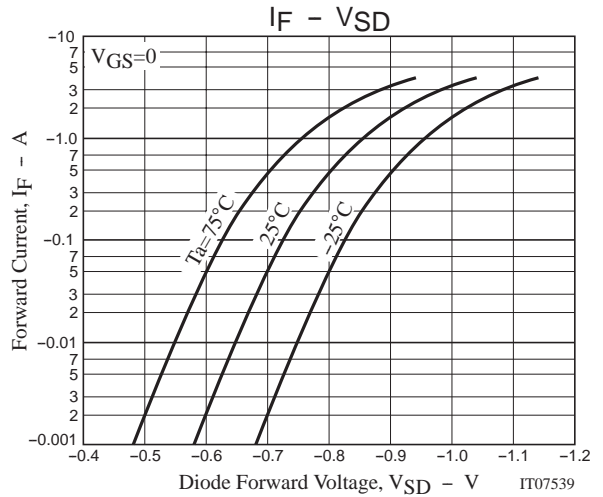
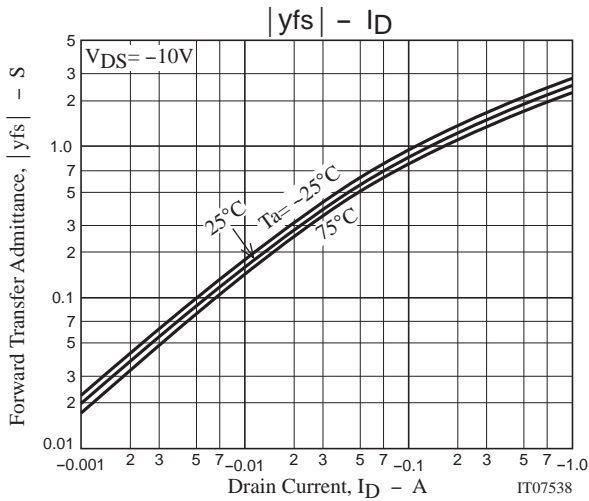

ON Semiconductor and the ON logo are registered trademarks of Semiconductor Components Industries, LLC (SCILLC). SCILLC reserves the right to make changes without further notice to any products herein. SCILLC makes no warranty, representation or guarantee regarding the suitability of its products for any particular purpose, nor does SCILLC assume any liability arising out of the application or use of any product or circuit, and specifically disclaims any and all liability, including without limitation special, consequential or incidental damages. SCILLC strives to supply high-quality high-reliability products and recommends adopting safety measures when designing equipment to avoid accidents or malfunctions. Such measures include but are not limited to protective circuits and error prevention circuits for safe design, redundant design, and structural design. "Typical" parameters which may be provided in SCILLC data sheets and/or specifications can and do vary in different applications and actual performance may vary over time. All operating parameters, including "Typicals," must be validated for each customer application by customer's technical experts. SCILLC shall not be held liable for any claim or suits with regard to a third party's intellectual property rights which has resulted from the use of the technical information and products mentioned above. SCILLC does not convey any license under its patent rights nor the rights of others. SCILLC products are not designed, intended, or authorized for use as components in systems intended for surgical implant into the body, or other applications intended to support or sustain life, or for any other application in which the failure of the SCILLC product could create a situation where personal injury or death may occur. Should Buyer purchase or use SCILLC products for any such unintended or unauthorized application, Buyer shall indemnify and hold SCILLC and its officers, employees, subsidiaries, affiliates, and distributors harmless against all claims, costs, damages, and expenses, and reasonable attorney fees arising out of, directly or indirectly, any claim of personal injury or death associated with such unintended or unauthorized use, even if such claim alleges that SCILLC was negligent regarding the design or manufacture of the part. SCILLC is an Equal Opportunity/Affirmative Action Employer. This literature is subject to all applicable copyright laws and is not for resale in any manner.

## PUBLICATION ORDERING INFORMATION

### LITERATURE FULFILLMENT:

Literature Distribution Center for ON Semiconductor  
P.O. Box 5163, Denver, Colorado 80217 USA  
**Phone:** 303-675-2175 or 800-344-3860 Toll Free USA/Canada  
**Fax:** 303-675-2176 or 800-344-3867 Toll Free USA/Canada  
**Email:** [orderlit@onsemi.com](mailto:orderlit@onsemi.com)

**N. American Technical Support:** 800-282-9855 Toll Free  
USA/Canada.

**Europe, Middle East and Africa Technical Support:**  
Phone: 421 33 790 2910

**Japan Customer Focus Center**  
Phone: 81-3-5773-3850

**ON Semiconductor Website:** [www.onsemi.com](http://www.onsemi.com)

**Order Literature:** <http://www.onsemi.com/orderlit>

For additional information, please contact your local  
Sales Representative

## X-ON Electronics

Largest Supplier of Electrical and Electronic Components

*Click to view similar products for [MOSFET](#) category:*

*Click to view products by [ON Semiconductor](#) manufacturer:*

Other Similar products are found below :

[614233C](#) [648584F](#) [MCH3443-TL-E](#) [MCH6422-TL-E](#) [FDPF9N50NZ](#) [FW216A-TL-2W](#) [FW231A-TL-E](#) [APT5010JVR](#) [NTNS3A92PZT5G](#)  
[IRF100S201](#) [JANTX2N5237](#) [2SK2464-TL-E](#) [2SK3818-DL-E](#) [FCA20N60\\_F109](#) [FDZ595PZ](#) [STD6600NT4G](#) [FSS804-TL-E](#) [2SJ277-DL-E](#)  
[2SK1691-DL-E](#) [2SK2545\(Q,T\)](#) [D2294UK](#) [405094E](#) [423220D](#) [MCH6646-TL-E](#) [TPCC8103,L1Q\(CM](#) [367-8430-0972-503](#) [VN1206L](#)  
[424134F](#) [026935X](#) [051075F](#) [SBVS138LT1G](#) [614234A](#) [715780A](#) [NTNS3166NZT5G](#) [751625C](#) [873612G](#) [IRF7380TRHR](#)  
[IPS70R2K0CEAKMA1](#) [RJK60S3DPP-E0#T2](#) [RJK60S5DPK-M0#T0](#) [APT5010JVFR](#) [APT12031JFLL](#) [APT12040JVR](#) [DMN3404LQ-7](#)  
[NTE6400](#) [JANTX2N6796U](#) [JANTX2N6784U](#) [JANTXV2N5416U4](#) [SQM110N05-06L-GE3](#) [SIHF35N60E-GE3](#)