



SAW Components

SAW Duplexer

Cellular / WCDMA Band V

Series/type:	B8568
Ordering code:	B39881B8568P810
Date:	May 13, 2013
Version:	2.0



Application

- Multimode SAW duplexer for mobile telephone Cellular/WCDMA Band V, Band VI (830-840 MHz) and Band IXX (830-845 MHz) systems
- Low insertion attenuation
- Low amplitude ripple
- High Tx band isolation
- Single ended to balanced transformation in Antenna - Rx path
- Impedance transformation 50Ω to 100Ω in Antenna - Rx path

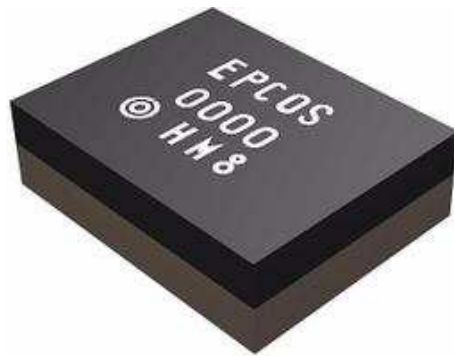

Features

- Component size 2.0 x 1.6 mm²
- Component height 0.47 mm max.
- RoHS compatible
- Approximate weight: 0.005g
- Package for **Surface Mount Technology (SMT)**
- Ni, gold-plated terminals
- **Electrostatic Sensitive Device (ESD)**
- **Moisture Sensitivity Level 3**

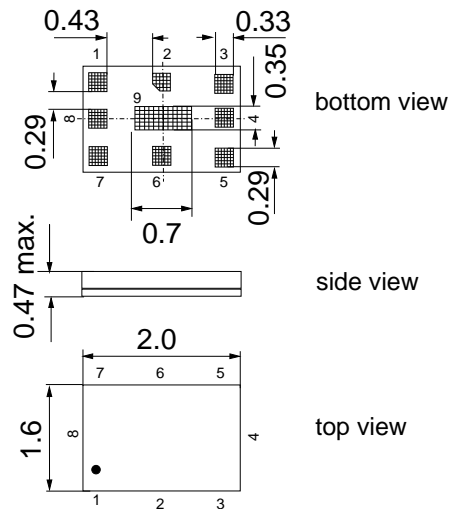

Pin configuration

- 3 TX Input
- 1, 8 RX Output (balanced)
- 6 Antenna
- 2, 4, 5, 7, 9 To be grounded

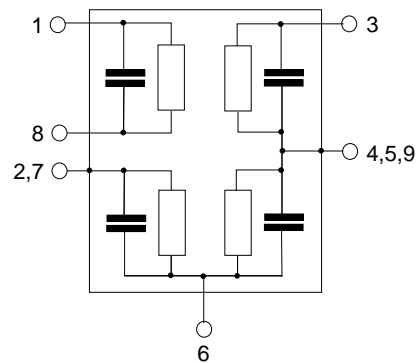



SAW Components	B8568
SAW Duplexer	836.50 / 881.50 MHz

Preliminary Data



Characteristics

Temperature range for specification: $T = -30\text{ °C to }+85\text{ °C}$
 Antenna terminating impedance: $Z_{ANT} = 50\ \Omega \parallel 8.2\text{ nH}$
 RX terminating impedance: $Z_{RX} = 100\ \Omega$ (balanced)
 TX terminating impedance: $Z_{TX} = 50\ \Omega$

Characteristics TX - ANT		min.	typ. @ 25 °C	max.	
Center frequency	f_C		836.5		MHz
Maximum insertion attenuation	α_{max}				
824.0 ... 849.0 MHz			1.4	2.4	dB
@ $f_{Carrier}$ 826.4 ... 846.6 MHz	$\alpha_{WCDMA}^{1)}$		1.2	2.1 ²⁾	dB
Amplitude ripple	$\Delta\alpha$				
824.0 ... 849.0 MHz			0.6	1.6	dB
@ $f_{Carrier}$ 826.4 ... 846.6 MHz	$\alpha_{WCDMA}^{1)}$		0.4	1.3 ²⁾	dB
Error Vector Magnitude					
@ $f_{Carrier}$ 826.4 ... 846.6 MHz	EVM ³⁾		1.7	3.5 ²⁾	%
Input VSWR (TX port)					
824.0 ... 849.0 MHz			1.4	2.1	
Output VSWR (ANT port)					
824.0 ... 849.0 MHz			1.4	2.1	

1) Attenuation of WCDMA signal ("Powertransferfunction"). Please refer to annotation on page (8).
 2) Temperature range for this parameter is -20°C to +85°C.
 3) Error Vector Magnitude (EVM) based on definition given in 3GPP TS 25.141.



SAW Components	B8568
SAW Duplexer	836.50 / 881.50 MHz

Preliminary Data



Characteristics

Temperature range for specification: T = -30 °C to +85 °C
 Antenna terminating impedance: Z_{ANT} = 50 Ω || 8.2 nH
 RX terminating impedance: Z_{RX} = 100 Ω (balanced)
 TX terminating impedance: Z_{TX} = 50 Ω

Characteristics TX - ANT		min.	typ. @ 25 °C	max.	
Absolute attenuation	α				
10.0 ... 420.0 MHz		30	40		dB
420.0 ... 494.0 MHz		35	37		dB
494.0 ... 701.0 MHz		30	33		dB
701.0 ... 728.0 MHz		30	33		dB
728.0 ... 768.0 MHz		31	34		dB
768.0 ... 804.0 MHz		28	31		dB
860.0 ... 869.0 MHz		3	27		dB
869.0 ... 894.0 MHz		45	51		dB
1565.42 ... 1573.374 MHz		36	42		dB
1573.374 ... 1577.466 MHz		36	42		dB
1577.466 ... 1585.42 MHz		36	42		dB
1597.5515 ... 1605.886 MHz		36	41		dB
1605.886 ... 1610.0 MHz		36	41		dB
1638.0 ... 1708.0 MHz		25	38		dB
1708.0 ... 1743.0 MHz		25	38		dB
1844.9 ... 1879.9 MHz		30	35		dB
1884.5 ... 1919.6 MHz		30	35		dB
1930.0 ... 1990.0 MHz		30	34		dB
2110.0 ... 2170.0 MHz		28	32		dB
2400.0 ... 2557.0 MHz		24	27		dB
2557.0 ... 2592.0 MHz		23	29		dB
3286.0 ... 3406.0 MHz		20	24		dB
4110.0 ... 4255.0 MHz		18	21		dB
4934.0 ... 5350.0 MHz		10	19		dB
5725.0 ... 5953.0 MHz		10	17		dB



SAW Components	B8568
SAW Duplexer	836.50 / 881.50 MHz

Preliminary Data



Characteristics

Temperature range for specification: $T = -30\text{ °C to }+85\text{ °C}$
 Antenna terminating impedance: $Z_{ANT} = 50\ \Omega \parallel 8.2\text{ nH}$
 RX terminating impedance: $Z_{RX} = 100\ \Omega$ (balanced)
 TX terminating impedance: $Z_{TX} = 50\ \Omega$

Characteristics ANT - RX		min.	typ. @ 25 °C	max.	
Center frequency	f_C		881.5		MHz
Maximum insertion attenuation	α_{max}				
869.0 ... 894.0 MHz			2.2	2.7	dB
@ $f_{Carrier}$ 871.4 ... 891.6 MHz	$\alpha_{WCDMA}^{1)}$		1.9	2.5 ²⁾	dB
Amplitude ripple (p-p)	$\Delta\alpha$				
869.0 ... 894.0 MHz			0.8	1.2	dB
@ $f_{Carrier}$ 871.4 ... 891.6 MHz	$\alpha_{WCDMA}^{1)}$		0.5	1.0 ²⁾	dB
Error Vector Magnitude					
@ $f_{Carrier}$ 871.4 ... 891.6 MHz	EVM ³⁾		1.5	3.2 ²⁾	%
Input VSWR (ANT port)					
869.0 ... 894.0 MHz			1.8	2.1	
Output VSWR (RX port)					
869.0 ... 894.0 MHz			1.7	2.2	
Common mode rejection ratio					
869.0 ... 894.0 MHz	CMRR	23 ⁴⁾	32 ⁴⁾		dB

¹⁾ Attenuation of WCDMA signal ("Powertransferfunction"). Please refer to annotation on page (8).

²⁾ Temperature range for this parameter is -20°C to +85°C.

³⁾ Error Vector Magnitude (EVM) based on definition given in 3GPP TS 25.141.

⁴⁾ A combination of 10° phase balance and 1 dB amplitude balance corresponds to 19.6 dB CMRR



SAW Components	B8568
SAW Duplexer	836.50 / 881.50 MHz

Preliminary Data **SMD**

Characteristics

Temperature range for specification: T = -30 °C to +85 °C
 Antenna terminating impedance: Z_{ANT} = 50 Ω || 8.2 nH
 RX terminating impedance: Z_{RX} = 100 Ω (balanced)
 TX terminating impedance: Z_{TX} = 50 Ω

Characteristics ANT - RX	min.	typ. @ 25 °C	max.			
IMD product level limits¹⁾						
at f_{TX} = 836.5 MHz f_{RX} = 881.5 MHz						
Blocker 1	45.0	MHz	-135	-110	dBm	
Blocker 2	791.5	MHz	-103	-93	dBm	
Blocker 3	1718.0	MHz	-109	-99	dBm	
Blocker 4	2554.5	MHz	-116	-106	dBm	
Attenuation						
		α				
10.0	...	447.0	MHz	45	85	dB
447.0	...	779.0	MHz	30	68	dB
779.0	...	784.0	MHz	45	67	dB
784.0	...	804.0	MHz	35	66	dB
804.0	...	824.0	MHz	30	64	dB
824.0	...	849.0	MHz	55	70	dB
849.0	...	854.0	MHz	10	61	dB
909.0	...	1000.0	MHz	15	19	dB
1000.0	...	1850.0	MHz	40	60	dB
1850.0	...	1920.0	MHz	40	60	dB
1920.0	...	2607.0	MHz	35	57	dB
2607.0	...	2682.0	MHz	50	56	dB
2682.0	...	6000.0	MHz	35	52	dB

¹⁾ Power levels: 21.5 dBm Tx signal, -15dBm blocker at antenna port.



SAW Components	B8568
SAW Duplexer	836.50 / 881.50 MHz

Preliminary Data **SMD**

Characteristics

Temperature range for specification: T = -30 °C to +85 °C
 Antenna terminating impedance: Z_{ANT} = 50 Ω || 8.2 nH
 RX terminating impedance: Z_{RX} = 100 Ω (balanced)
 TX terminating impedance: Z_{TX} = 50 Ω

Characteristics TX - RX				min.	typ. @ 25 °C	max.	
Isolation							
	824.0	...	849.0 MHz	60	67		dB
	869.0	...	894.0 MHz	50	54		dB
@f _{Carrier}	871.4	...	891.6 MHz α _{WCDMA} ¹⁾	50 ²⁾	54		dB
	1574.0	...	1577.0 MHz	40	72		dB
	1638.0	...	1708.0 MHz	20	70		dB
	2462.0	...	2557.0 MHz	20	63		dB
Common Mode Isolation							
	824.0	...	849.0 MHz	55	63		dB

1) Attenuation of WCDMA signal ("Powertransferfunction"). Please refer to annotation on page (8).
 2) Temperature range for this parameter is -20°C to +85°C.



SAW Components **B8568**

SAW Duplexer **836.50 / 881.50 MHz**

Preliminary Data **SMD**

Maximum ratings

Storage temperature range	T _{stg}	-40/+85	°C	
DC voltage	V _{DC}	5	V	
ESD voltage	V _{ESD}	250 ¹⁾	V	human body model, 1 pulse charged device model, 3 pulses machine model, 10 pulses source and load impedance 50 Ω } WCDMA UP wave } T = 55° C, 1000 h
		300 ²⁾	V	
		100 ³⁾	V	
Input power at 824.0 ... 849.0 MHz elsewhere	P _{IN}	29	dBm	}
		10	dBm	

- 1) acc. to JESD22-A114F (human body model), 1 negative & 1 positive pulse.
- 2) acc. to JESD22-C101E (charged device model), 3 negative & 3 positive pulses.
- 3) acc. to JESD22-A115C (machine model), 10 negative & 10 positive pulses.

Annotation for characteristics section

Attenuation of WCDMA signal ("Powertransferfunction", α_{WCDMA}) is determined by

$$\int_{-\infty}^{\infty} |S_{ds21}(f)H_{RRC}(f - f_{Carrier})|^2 df$$

f_{Carrier} according to 3GPP TS 25.101 (e.g. for WCDMA Band 5-Passband, f_{Carrier} ranges from 826.4 MHz (lowest Tx channel) to 846.6 MHz (highest Tx channel)). H_{RRC}(f) is the transfer function of the root-raised cosine transmit pulse shaping filter according to 3GPP TS 25.101 with the following normalization:

$$\int_{-\infty}^{\infty} |H_{RRC}(f)|^2 df = 1$$



SAW Components

B8568

SAW Duplexer

836.50 / 881.50 MHz

Preliminary Data



Frequency Response TX-ANT (Passband)

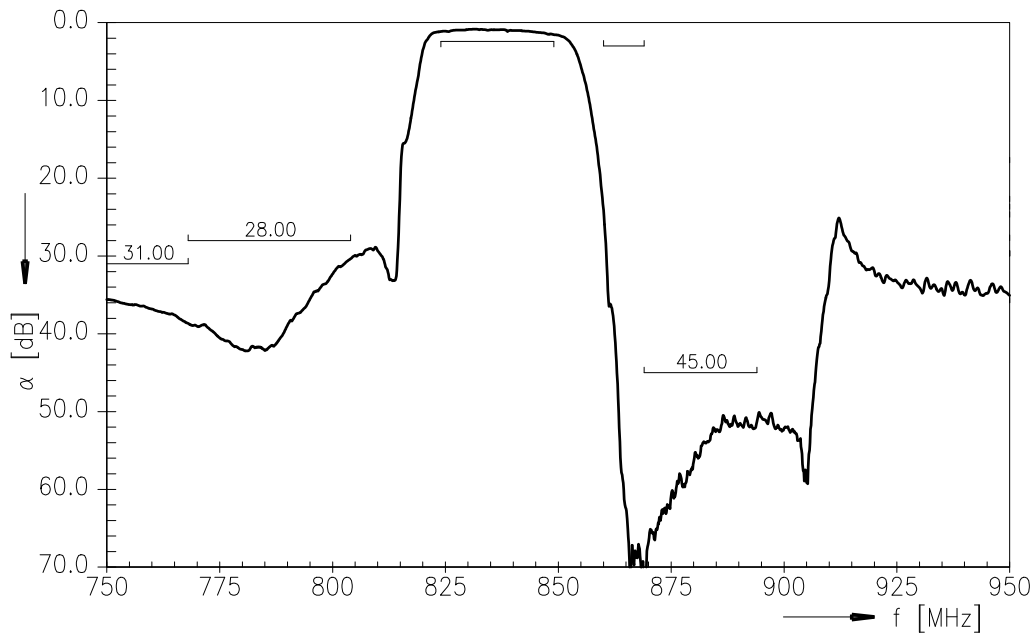

Frequency Response TX-ANT (Wideband)

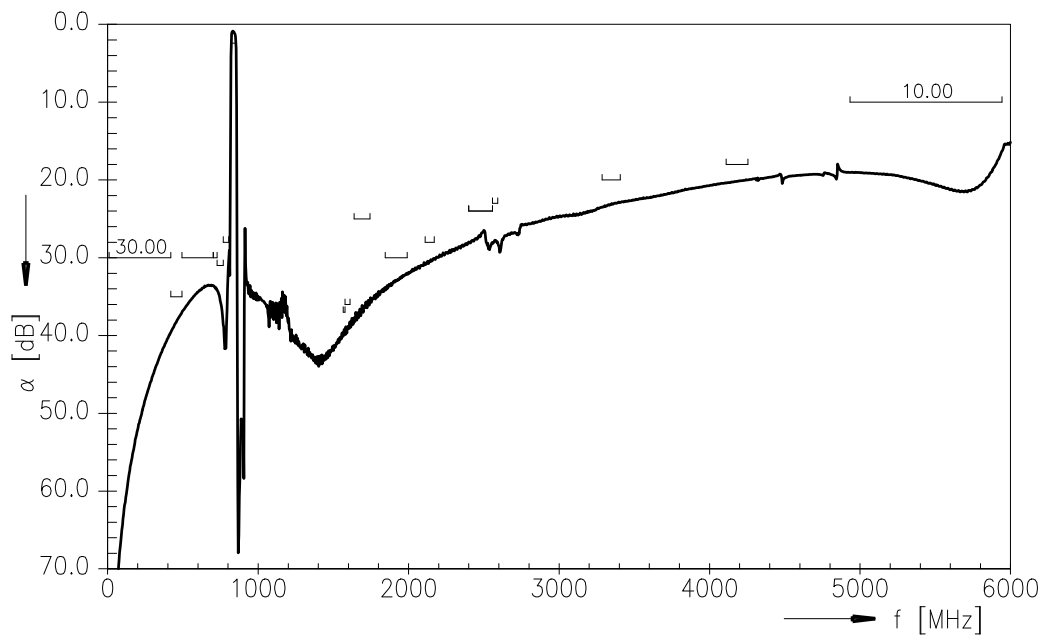

Please read *cautions and warnings* and *important notes* at the end of this document.



SAW Components

B8568

SAW Duplexer

836.50 / 881.50 MHz

Preliminary Data



Frequency Response RX-ANT (Passband)

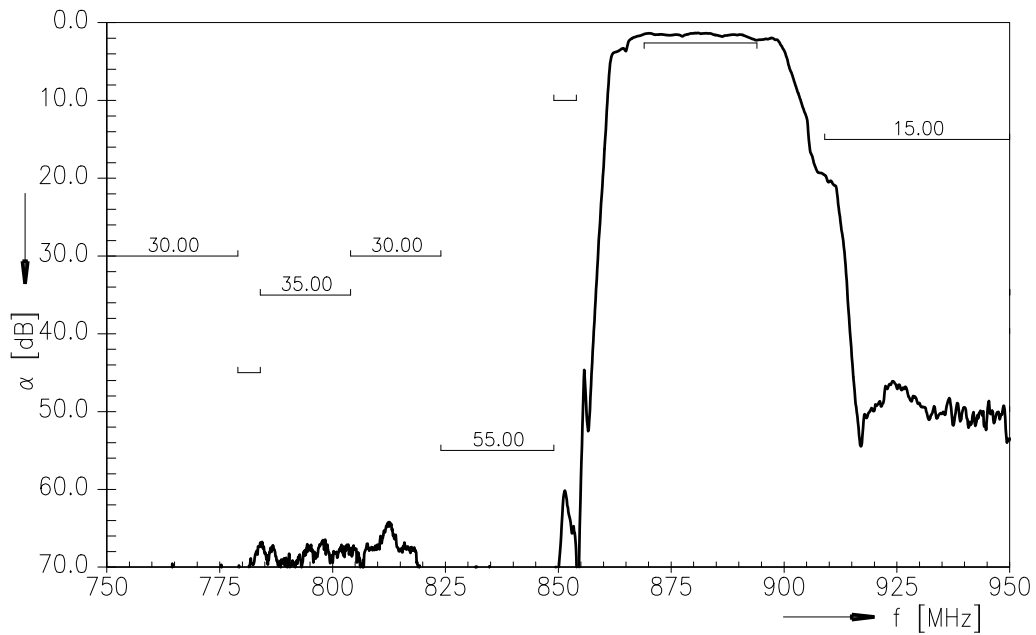

Frequency Response RX-ANT (Wideband)

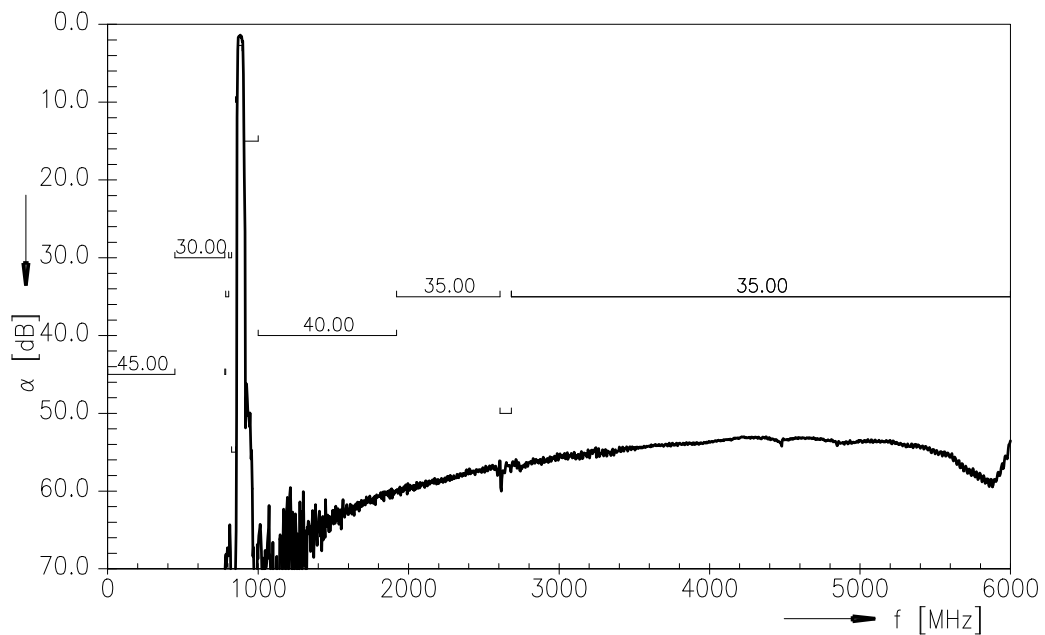

Please read *cautions and warnings* and *important notes* at the end of this document.



SAW Components

B8568

SAW Duplexer

836.50 / 881.50 MHz

Preliminary Data



Frequency Response TX-RX (Passband Differential Mode Isolation)

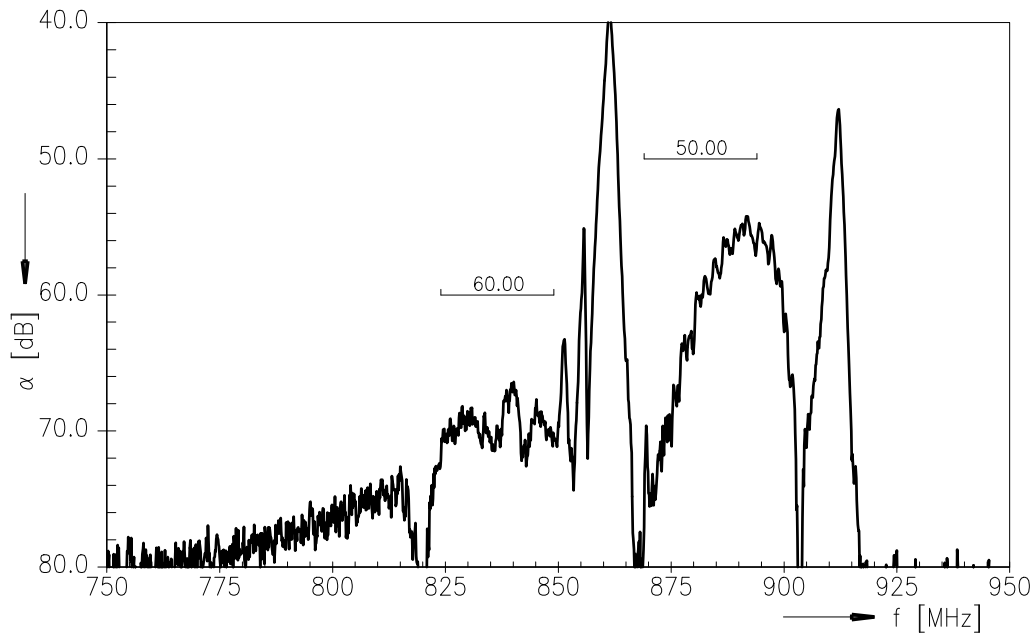

Frequency Response TX-RX (Wideband Differential Mode Isolation)

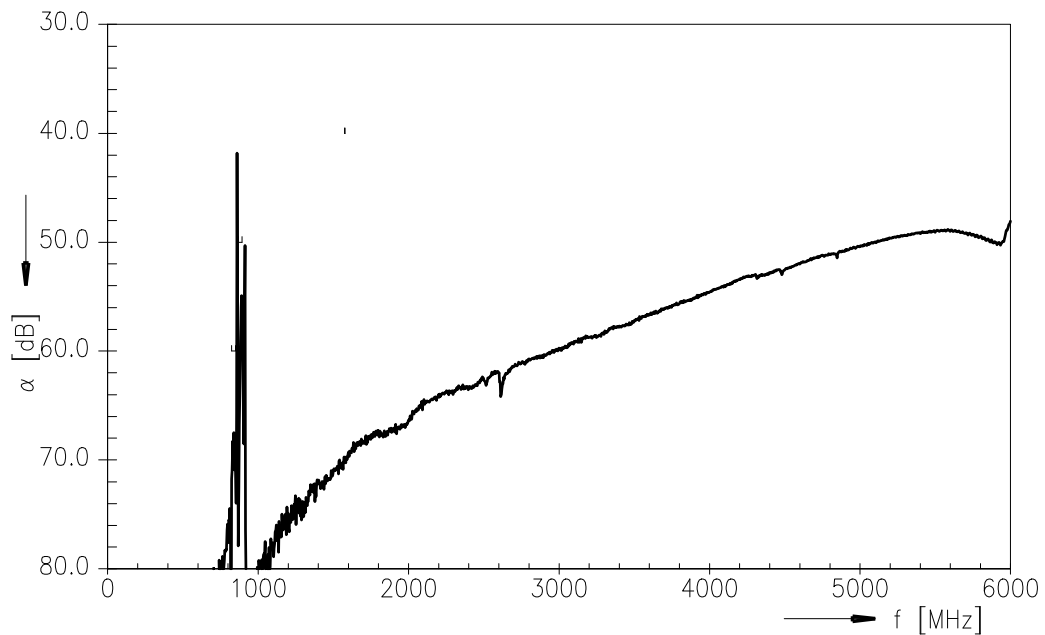

Please read *cautions and warnings* and *important notes* at the end of this document.



SAW Components

B8568

SAW Duplexer

836.50 / 881.50 MHz

Preliminary Data



Frequency Response TX-RX (Passband Common Mode Isolation)

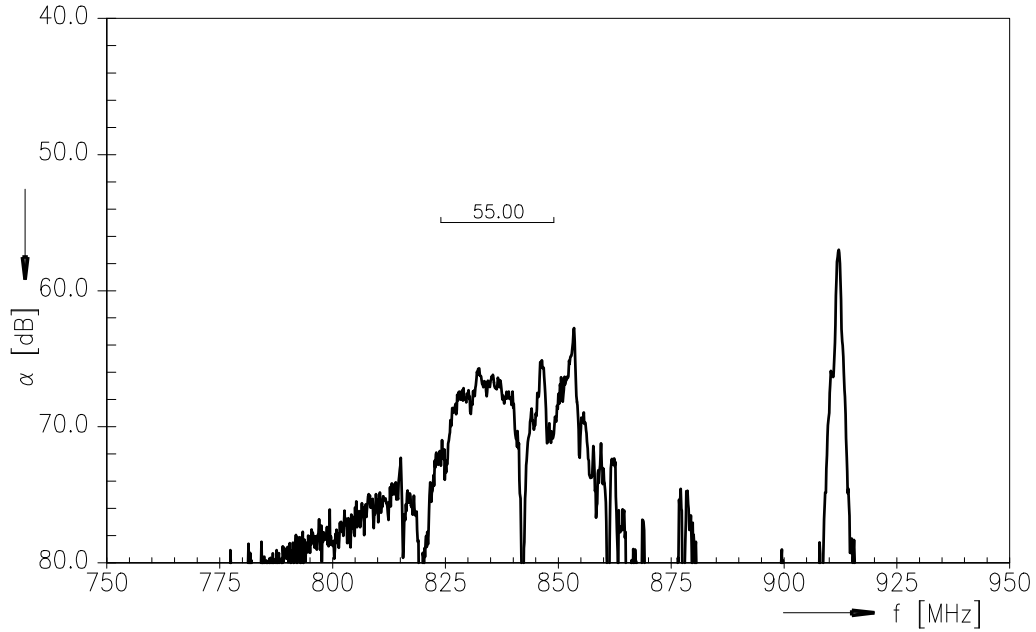

Frequency Response TX-RX (Wideband Common Mode Isolation)

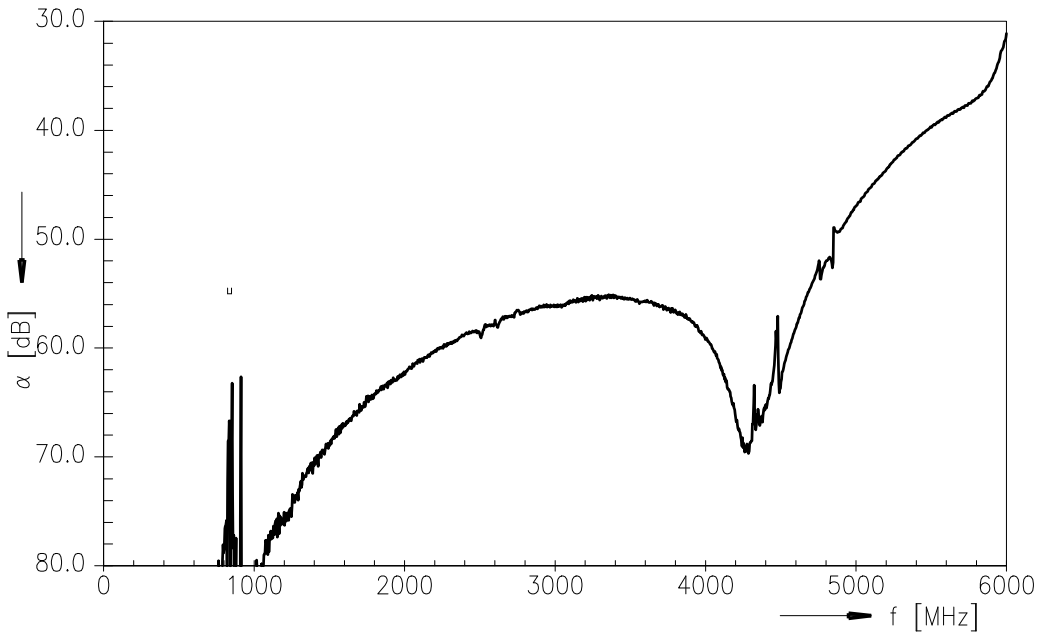

Please read *cautions and warnings* and *important notes* at the end of this document.



SAW Components

B8568

SAW Duplexer

836.50 / 881.50 MHz

Preliminary Data



Matching (TX, RX, ANT)

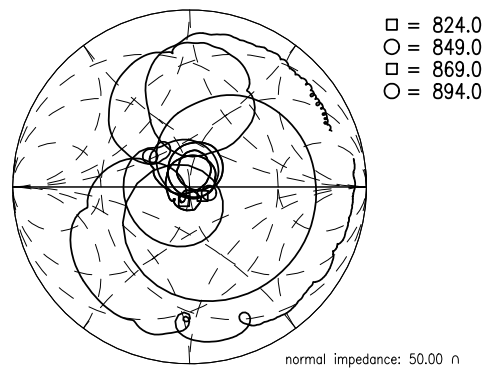
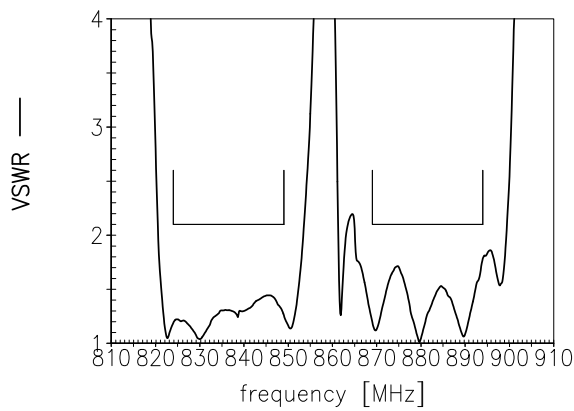
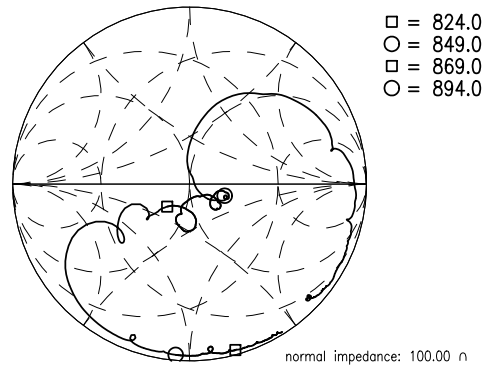
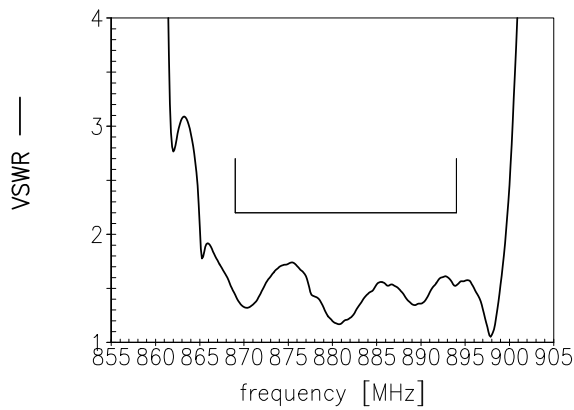
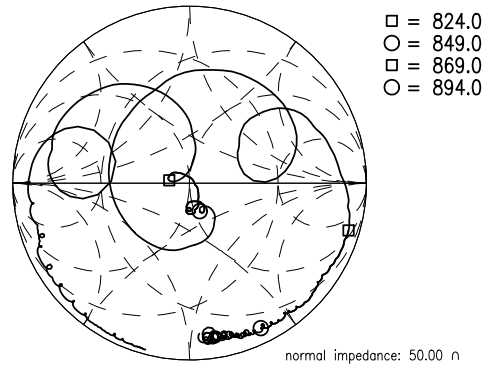
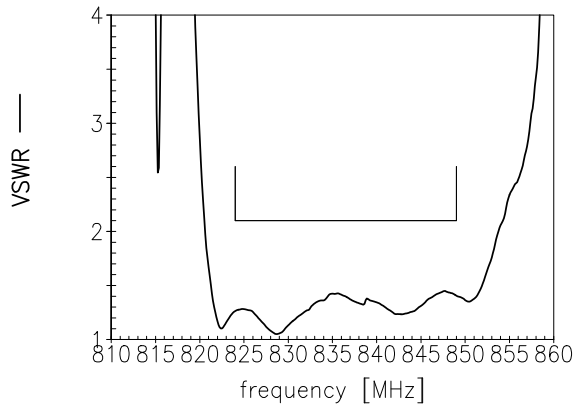

Please read *cautions and warnings* and *important notes* at the end of this document.



SAW Components	B8568
SAW Duplexer	836.50 / 881.50 MHz
Preliminary Data	SMD

References

Type	B8568
Ordering code	B39881B8568P810
Marking and package	C61157-A8-A38
Packaging	F61074-V8247-Z000
Date codes	L_1126
S-parameters	B8568_UN_NB.s4p, B8568_UN_WB.s4p; see file header for pin/port assignments;
Soldering profile	S_6001
RoHS compatible	RoHS-compatible means that products are compatible with the requirements according to Art. 4 (substance restrictions) of Directive 2011/65/EU of the European Parliament and of the Council of June 8 th , 2011, on the restriction of the use of certain hazardous substances in electrical and electronic equipment ("Directive") with due regard to the application of exemptions as per Annex III of the Directive in certain cases.
Matching coils	See Inductor pdf-catalog http://www.tdk.co.jp/tefe02/coil.htm#aname1 and Data Library for circuit simulation http://www.tdk.co.jp/etvcl/index.htm for a large variety of matching coils.

For further information please contact your local EPCOS sales office or visit our webpage at www.epcos.com.

Published by EPCOS AG
Systems, Acoustics, Waves Business Group
P.O. Box 80 17 09, 81617 Munich, GERMANY

© EPCOS AG 2013. This brochure replaces the previous edition.

For questions on technology, prices and delivery please contact the Sales Offices of EPCOS AG or the international Representatives.

Due to technical requirements components may contain dangerous substances. For information on the type in question please also contact one of our Sales Offices.

Please read *cautions and warnings and important notes* at the end of this document.



Important notes

The following applies to all products named in this publication:

1. Some parts of this publication contain **statements about the suitability of our products for certain areas of application**. These statements are based on our knowledge of typical requirements that are often placed on our products in the areas of application concerned. We nevertheless expressly point out **that such statements cannot be regarded as binding statements about the suitability of our products for a particular customer application**. As a rule, EPCOS is either unfamiliar with individual customer applications or less familiar with them than the customers themselves. For these reasons, it is always ultimately incumbent on the customer to check and decide whether an EPCOS product with the properties described in the product specification is suitable for use in a particular customer application.
2. We also point out that **in individual cases, a malfunction of electronic components or failure before the end of their usual service life cannot be completely ruled out in the current state of the art, even if they are operated as specified**. In customer applications requiring a very high level of operational safety and especially in customer applications in which the malfunction or failure of an electronic component could endanger human life or health (e.g. in accident prevention or life-saving systems), it must therefore be ensured by means of suitable design of the customer application or other action taken by the customer (e.g. installation of protective circuitry or redundancy) that no injury or damage is sustained by third parties in the event of malfunction or failure of an electronic component.
3. **The warnings, cautions and product-specific notes must be observed.**
4. In order to satisfy certain technical requirements, **some of the products described in this publication may contain substances subject to restrictions in certain jurisdictions (e.g. because they are classed as hazardous)**. Useful information on this will be found in our Material Data Sheets on the Internet (www.epcos.com/material). Should you have any more detailed questions, please contact our sales offices.
5. We constantly strive to improve our products. Consequently, **the products described in this publication may change from time to time**. The same is true of the corresponding product specifications. Please check therefore to what extent product descriptions and specifications contained in this publication are still applicable before or when you place an order. We also **reserve the right to discontinue production and delivery of products**. Consequently, we cannot guarantee that all products named in this publication will always be available. The aforementioned does not apply in the case of individual agreements deviating from the foregoing for customer-specific products.
6. Unless otherwise agreed in individual contracts, **all orders are subject to the current version of the "General Terms of Delivery for Products and Services in the Electrical Industry" published by the German Electrical and Electronics Industry Association (ZVEI)**.
7. The trade names EPCOS, BAOKE, Alu-X, CeraDiode, CeraLink, CSMP, CSSP, CTVS, DeltaCap, DigiSiMic, DSSP, FilterCap, FormFit, MiniBlue, MiniCell, MKD, MKK, MLSC, MotorCap, PCC, PhaseCap, PhaseCube, PhaseMod, PhiCap, SIFERRIT, SIFI, SIKOREL, SilverCap, SIMDAD, SiMic, SIMID, SineFormer, SIOV, SIP5D, SIP5K, ThermoFuse, WindCap are **trademarks registered or pending** in Europe and in other countries. Further information will be found on the Internet at www.epcos.com/trademarks.

X-ON Electronics

Largest Supplier of Electrical and Electronic Components

Click to view similar products for [epcos](#) manufacturer:

Other Similar products are found below :

[B82432X001](#) [B82731H2501A30](#) [B25673A4302A080](#) [B32529C0104K000](#) [B43501B3337M7](#) [B44066R6012E230](#) [B57235S0100M](#)
[B57236S0200M](#) [B57236S0259M](#) [B57237S0100M](#) [B57237S0109M](#) [B57237S0229M](#) [B57237S0259M](#) [B57237S0330M](#) [B72520T0250K062](#)
[B82422A1102K100](#) [B82422A1333K100](#) [B82422A1472K100](#) [B82721A2202N001](#) [B84142A50R](#) [B84143B600S20](#) [B84144A0120R000](#)
[B84144A90R120](#) [B84243A8008W](#) [B88069X0270S102](#) [BR6000-R6](#) [B25631A1506K200](#) [B32656S0105K561](#) [B32656T684K](#)
[B32686A7104K](#) [B32913A5154M](#) [B41550E7229Q000](#) [B43252A5476M](#) [B57236S0509M](#) [B57237S0150M](#) [B57237S0479M](#) [B57237S0509M](#)
[B59955C0120A070](#) [B59995C0120A070](#) [B64290A0045X038](#) [B72240B321K1](#) [B72530T0400K062](#) [B72530T250K62](#) [B82422A1473K100](#)
[B84144A50R](#) [B32332I6755J080](#) [B32521C1105J](#) [B32673P6474K000](#) [B43504B2108M000](#) [B43508A9827M](#)