

## MTC Series



- 10-40 VDC Input Range
- Designed for Vetric & Avionic Use
- Magnetic Feedback Technology
- -55 °C to +100 °C Operation
- MIL-STD 461 and DEF-STAN 59-411
- MIL-STD 1275 and DEF-STAN 61-5
- 3 Year Warranty

## Specification

## Input

Input Voltage Range	• 10.0-40.0 VDC
Transient Input Range	• 50 VDC for 100 ms
Inrush Current	• <40 A at 28 VDC
Turn On	• >9.5 VDC
Turn Off	• <9.0 VDC
Input Reverse Voltage Protection	• None
Input Current	• See table

## Output

Output Voltage	• See table
Output Voltage Trim	• -20%, +10% ( $\pm 10\%$ for 3.3 V version), see note 2
Minimum Load	• No minimum load required on single output models, 5% load required on each output of dual output models
Line Regulation	• $\pm 1\%$ Vout nominal
Load Regulation	• Single Output: $\pm 1\%$ Vout nominal, Dual Output: $\pm 2\%$
Output Set Tolerance	• $\pm 1.5\%$ max
Ripple & Noise	• $\leq 5$ mV Vout: 50 mV pk-pk max, $>5$ Vout: 100 mV pk-pk, at max load and 20 MHz bandwidth
Overvoltage Protection	• 120-140% Vout max
Overcurrent Protection	• 110-140% at nominal Iout, constant power down to 40-50% of nominal output voltage
Short Circuit Protection	• Continuous trip and restart (hiccup mode) until the short is removed
Maximum Capacitive Load	• 300 $\mu$ F x Iout max for startup within 100 ms
Thermal Warning	• Active when internal temp is $>105$ °C
Remote Sense	• Compensates for 0.5 V total voltage drop
Cross Regulation	• $\pm 4\%$ on dual outputs (see note 3)
Transient Response	• $\pm 4\%$ max deviation recovery to within 1% in 500 $\mu$ s for a 50% load change at 0.1 A/ $\mu$ s
Start Up Time	• <100 ms
Start Up Rise Time	• <20 ms
Current Share	• Parallel up to 4 modules, single output versions only (MTC75 & 150 only)
Temperature Coefficient	• 0.03%/°C
Remote On/Off	• On: $\geq 3.5$ V or open circuit, Off: $\leq 1.8$ V

## General

Efficiency	• See table
Isolation	• 1500 VDC Input to Output 1000 VDC Input to Case 1000 VDC Output to Case
Isolation Capacitance	• 2500 pF
Switching Frequency	• Fixed, 400 kHz typical (MTC35 & 50) 450 kHz typical (MTC75 & 150)
Frequency Synchronization	• 400-500 kHz (MTC35 & 50) 450-550 kHz (MTC75 & 150)
Power Density	• MTC35: 31.8 W/in <sup>3</sup> , MTC50: 30.2 W/in <sup>3</sup> , MTC75: 27.4 W/in <sup>3</sup> , MTC150: 54.8 W/in <sup>3</sup>
MTBF	• >1 Mhrs to MIL-HDBK-217F at 25 °C, GF

## Environmental

Case Temperature	• -40 °C to +100 °C (start up at -55 °C)
Storage Temperature	• -60 °C to +125 °C
Cooling	• Conduction cooling through baseplate
Operating Humidity	• 95% Relative Humidity 240 hrs MIL-STD-810F Method 507.4
Operating Altitude	• Tested to 70000 ft (21336 m)
Shock	• 75 g MIL-STD-810F Method 516.5
Vibration	• 15 to 2000 Hz MIL-STD-810F Method 514.5, table 514.5-VIII
Bump	• 2000 Bumps in each axis 40 g MIL-STD-810F Method 516.5
Salt Atmosphere	• 48 hrs MIL-STD-810F Method 509.4

## EMC

Conducted Emissions	• EN55022 Conducted Level B* MIL-STD 461F: CE102* DEF STAN 59-411 DCE01/DCE02*
Immunity	• MIL-STD-704 B-F, MIL-STD-1275A/B/C/D*
Conducted Susceptibility	• MIL-STD-461F CS101, CS114, CS115, CS116* DEF-STAN 61-5 part 6 issue 5*

\* When used in conjunction with standard EMI filter and surge protection modules, DSF and FSO series. Consult longform datasheet.

**Models and Ratings**

Output Power	Output Voltage	Output Current	Input Current <sup>(1)</sup>		Efficiency <sup>(1)</sup>	Model Number
			No Load	Full Load		
35 W	3.3 VDC	10.00 A	100 mA	1.49 A	84%	MTC3528S3V3
35 W	5.0 VDC	7.00 A	100 mA	1.45 A	86%	MTC3528S05
35 W	12.0 VDC	2.90 A	100 mA	1.41 A	88%	MTC3528S12
35 W	15.0 VDC	2.30 A	100 mA	1.40 A	88%	MTC3528S15
35 W	28.0 VDC	1.30 A	100 mA	1.48 A	88%	MTC3528S28
50 W	3.3 VDC	15.00 A	100 mA	2.18 A	82%	MTC5028S3V3
50 W	5.0 VDC	10.00 A	60 mA	2.15 A	83%	MTC5028S05
50 W	12.0 VDC	4.20 A	70 mA	2.13 A	84%	MTC5028S12
50 W	15.0 VDC	3.33 A	70 mA	2.13 A	84%	MTC5028S15
50 W	28.0 VDC	1.80 A	120 mA	2.15 A	83%	MTC5028S28

**Notes**

- 1. Typical and measured at 28 V input
- 2. Total of voltage trim and remote sense is +10% max.

**Mechanical Details**

**MTC35**

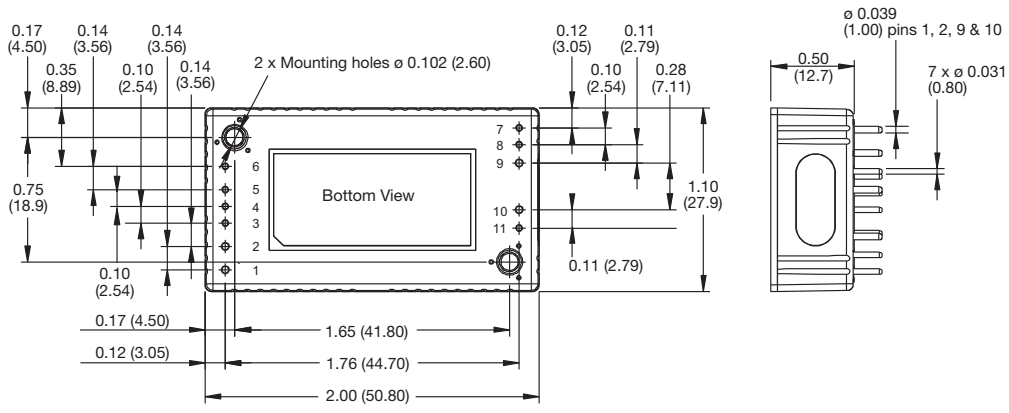

**Notes**

- 1. Dimensions are in inches (mm)
- 2. Tolerance: ±0.02 inches (±0.5 mm)
- 3. Weight: 0.07 lb (35 g) approx

**4. Materials & Finish:**

Pin - Material: Copper  
 Finish: Nickel plated 2.5 µm Ni and gold plated 0.3 µm Au.  
 Mounting Hole Diameter - 0.10 (2.7) clearance hole  
 Baseplate - Material: Aluminium  
 Case - Material: Non-conductive plastic

Pin Connections			
Pin	Single Output	Pin	Single Output
1	+Vin	7	Trim
2	-Vin	8	-Sense
3	Thermal Warning (TW)	9	-Vout
4	Synchronization	10	+Vout
5	Remote On/Off	11	+Sense
6	Case		

**MTC50**

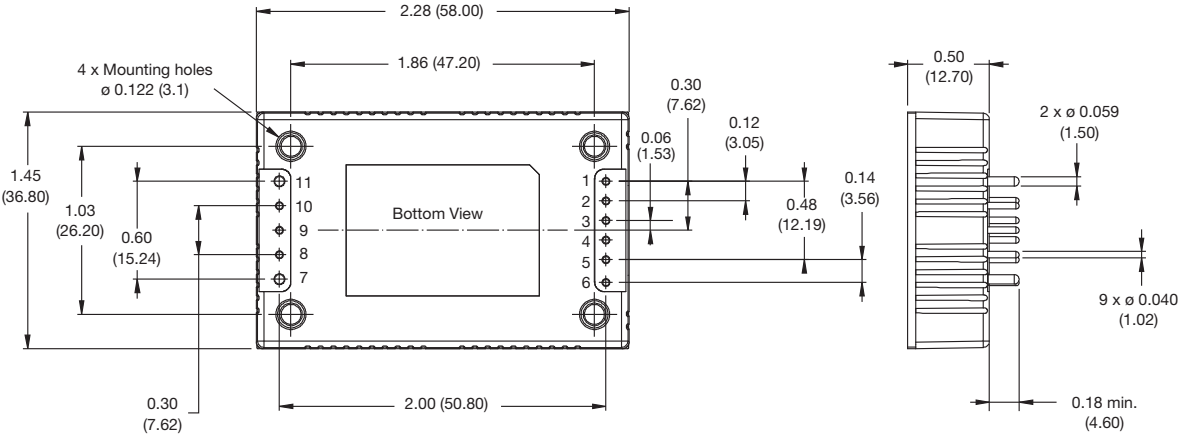

**Notes**

- 1. Dimensions are in inches (mm)
- 2. Tolerance: ±0.02 inches (±0.5 mm)
- 3. Weight: 0.14 lb (62 g) approx

**4. Materials & Finish:**

Pin - Material: Copper  
 Finish: Nickel plated 2.5 µm Ni and gold plated 0.3 µm Au.  
 Mounting Hole Diameter - 0.126 (3.2) clearance hole  
 Baseplate - Material: Aluminium  
 Case - Material: Non-conductive plastic

Pin Connections			
Pin	Single Output	Pin	Single Output
1	+Vin	7	-Vout
2	Remote On/Off	8	-Sense
3	Synchronization	9	Trim
4	Thermal Warning (TW)	10	+Sense
5	-Vin	11	+Vout
6	Case		



## Models and Ratings

Output Power	Output Voltage	Output Current	Input Current <sup>(1)</sup>		Efficiency <sup>(1)</sup>	Model Number
			No Load	Full Load		
66 W	3.3 VDC	20.00 A	120 mA	2.87 A	82%	MTC7528S3V3
75 W	5.0 VDC	15.00 A	130 mA	3.19 A	84%	MTC7528S05
75 W	12.0 VDC	6.25 A	60 mA	3.19 A	84%	MTC7528S12
75 W	15.0 VDC	5.00 A	40 mA	3.19 A	84%	MTC7528S15
75 W	28.0 VDC	2.70 A	75 mA	3.23 A	83%	MTC7528S28
75 W	±12.0 VDC	±3.13 A <sup>(4)</sup>	220 mA	3.23 A	83%	MTC7528D12 <sup>(3)</sup>
75 W	±15.0 VDC	±2.50 A <sup>(4)</sup>	230 mA	3.27 A	82%	MTC7528D15 <sup>(3)</sup>
132 W	3.3 VDC	40.00 A	120 mA	5.82 A	81%	MTC15028S3V3
150 W	5.0 VDC	30.00 A	147 mA	6.38 A	84%	MTC15028S05
150 W	12.0 VDC	12.50 A	70 mA	6.38 A	84%	MTC15028S12
150 W	15.0 VDC	10.00 A	75 mA	6.30 A	86%	MTC15028S15
150 W	28.0 VDC	5.35 A	170 mA	6.30 A	86%	MTC15028S28
150 W	±12.0 VDC	±6.25 A <sup>(4)</sup>	250 mA	6.38 A	84%	MTC15028D12 <sup>(3)</sup>
150 W	±15.0 VDC	±5.00 A <sup>(4)</sup>	275 mA	6.31 A	85%	MTC15028D15 <sup>(3)</sup>

### Notes

1. Typical and measured at 28 V input
2. Total of voltage trim and remote sense is +10% max.
3. Minimum load of 5% required on one output for ±4% regulation on the other.
4. Each output can deliver 70% of the combined current when other output delivers between 5% and 30%.

## Mechanical Details

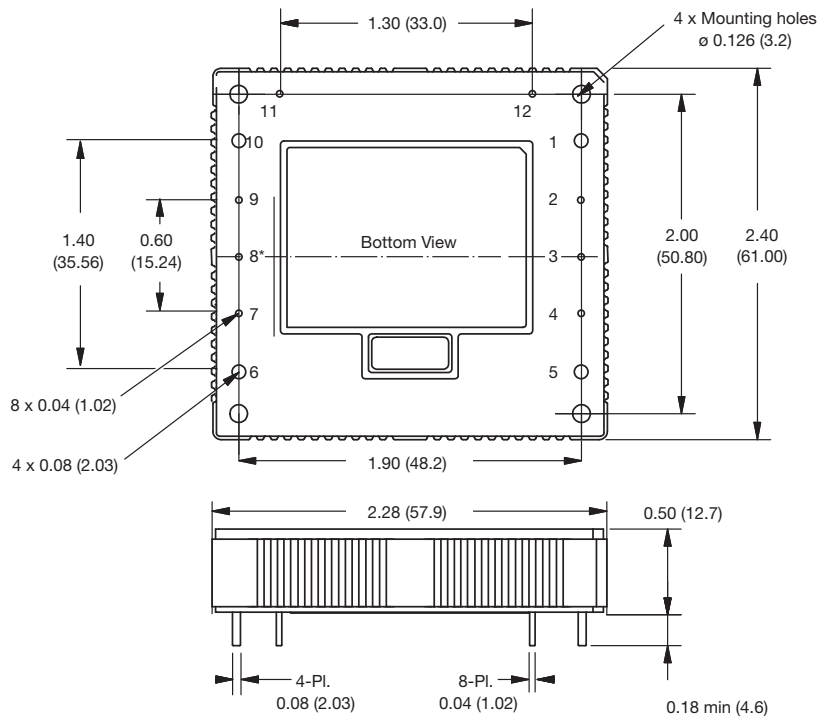

### Notes

1. Dimensions are in inches (mm)
2. Tolerance: ±0.02 inches (±0.5 mm)
3. Weight: 0.28 lb (128 g) approx
4. Materials & Finish:
  - Pin - Material: Copper; Finish: Nickel plated 2.5 µm Ni and gold plated 0.3 µm Au.
  - Mounting Hole Diameter - Material: Aluminium; Finish: 0.126 (3.2) clearance hole
  - Baseplate - Material: Aluminium
  - Case - Material: Non-conductive plastic

\*On dual output versions, Pin 8 is 0.08 (2.03)

Pin Connections		
Pin	Single Output	Dual Output
1	+Vin	+Vin
2	Remote On/Off	Remote On/Off
3	Thermal Warning (TW)	Thermal Warning (TW)
4	Case	Case
5	-Vin	-Vin
6	-Vout	-Vout
7	-Sense	Trim
8*	Trim	Common
9	+Sense	No Pin
10	+Vout	+Vout
11	Share	No Pin
12	Synchronization	Synchronization

Remote On/Off

This is an active low signal referenced to -Vin. If >3.5V (or open circuit) is applied, the output is on. If <1.8V (or short circuit) is applied, the output is off. If module inhibit is not required, leave the pin floating.

Thermal Warning (Tw)

This is an open collector signal with emitter connected to -Vin. Transistor is off under normal conditions and is turned on when trip threshold is exceeded (typically 105 °C).

Thermal Shutdown

The output of the module can be optionally turned off under a high temperature condition by connecting the Thermal Warning (TW) pin directly to the Remote On/Off pin. Auto resetting.

Synchronization

The internal switching frequency can be synchronized to an external source within the range 450 to 550 kHz (MTC75 & 150) or 400 to 500 kHz (MTC35 & 50). If two modules or more are synchronized, they will run at the highest frequency. Connect synchronization pins directly together.

Share

Up to four modules can be forced to share by connecting the share pins directly together, derate maximum output to 90% of total power. (MTC75 & 150 W only)

Output Trim

In order to trim the output voltage of the singles up or down, connect the trim resistor either between the trim pin and +sense for trimming-up or between trim pin and -sense for trimming-down. In order to trim the output voltage of the duals up or down, connect the trim resistor either between the trim pin and +Vout for trimming up or between trim pin and -Vout for trimming down. The trimming output voltage range is ±10% on 3V3 output voltage and -20% to +10% rated output voltage on others. See diagram & table below.

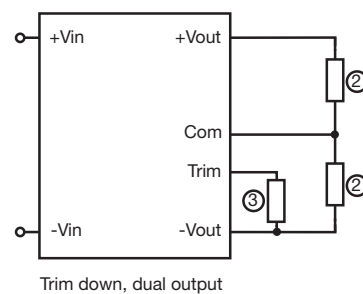
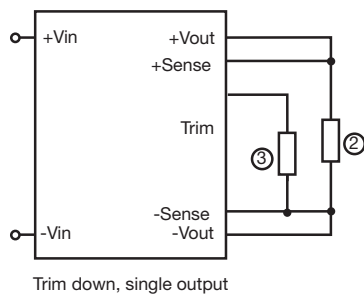
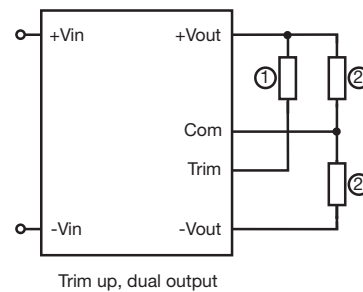
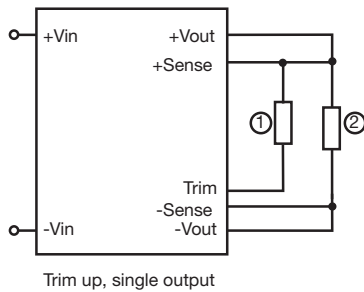

① = R Trim-up    ② = R-Load    ③ = R Trim-down

Trim up resistor=

$$R \text{ trim-up} = \left[ \frac{A}{1 - \frac{V_{nom}}{V_{required}}} - C \right] \text{ k}\Omega$$

Trim down resistor=

$$R \text{ trim-down} = \left[ \frac{B}{\frac{V_{nom}}{V_{required}} - 1} - C \right] \text{ k}\Omega$$

MTC35 & 50					
	S3V3	S05	S12	S15	S28
A	9.826	15	43.814	56.056	81.993
B	6	5	5.1	5.1	3.825
C	5.1	5.1	5.1	5.1	9.1

MTC75 & 150							
	S3V3	S05	S12	S15	S28	D12	D15
A	9.826	15	21.907	28.028	54.622	46.446	58.524
B	6	5	2.55	2.55	2.55	2.55	2.55
C	5.1	5.1	5.1	5.1	9.1	9.1	9.1

## X-ON Electronics

Largest Supplier of Electrical and Electronic Components

*Click to view similar products for [Isolated DC/DC Converters](#) category:*

*Click to view products by [XP Power](#) manufacturer:*

Other Similar products are found below :

[ESM6D044440C05AAQ](#) [FMD15.24G](#) [PSL486-7LR](#) [PSR152.5-7IR](#) [Q48T30020-NBB0](#) [AVO240-48S12B-6L](#) [AVO250-48S28B-6L](#) [NAN-0505](#) [HW-L16D](#) [JAHW100Y1](#) [217-1617-001](#) [22827](#) [SPB05C-12](#) [SQ24S15033-PS0S](#) [18952](#) [19-130041](#) [CE-1003](#) [CE-1004](#) [GQ2541-7R](#) [PSE1000DCDC-12V](#) [RDS180245](#) [MAU228](#) [419-2065-201](#) [449-2075-101](#) [TME 0303S](#) [TME 0505S](#) [TME 1205S](#) [TME 1212S](#) [TME 2405S](#) [TME 2412S](#) [J80-0041NL](#) [V300C24C150BG](#) [419-2062-200](#) [419-2063-401](#) [419-2067-101](#) [419-2067-501](#) [419-2068-001](#) [DCG40-5G](#) [DFC15U48D15](#) [449-2067-000](#) [XGS-0512](#) [XGS-1205](#) [XGS-1212](#) [XGS-2412](#) [XGS-2415](#) [XKS-1215](#) [033456](#) [NCT1000N040R050B](#) [SPB05B-15](#) [SPB05C-15](#)