

## FF2 and FF3 Series

---

### Magnetically Actuated Non-Contact Barrel Safety Switches



#### DESCRIPTION

The FF2 is an 18 mm barrel (thread) mounting magnetically actuated safety switch with one safety contact and an optional indicator contact, if required. The FF3 is a 30 mm barrel (thread) mounting magnetically actuated safety switch with up to two safety contacts and one indicator contact.

#### FEATURES

---

- Options of one or two safety contacts
- Tested to over 1,000,000 operations, full load
- Simple M18 and M30 barrel (thread) mounting
- Guard status indication available
- ac and dc versions
- CE and UL approvals

The barrel, thread, mount design is easy to install into the frame of a machine guard and allows for flush mounting, reducing potential switch damage and space constraint issues. Both the FF2 and FF3 series are sealed to IP67 requirements enabling use in most harsh environments.

#### POTENTIAL APPLICATIONS

---

- Can forming and filling (aluminum, steel, and plastic)
- Pick and place packaging equipment
- Pick and place/assembly equipment
- Semicon equipment
- Plastic molding equipment
- Woodworking machinery
- Textile machinery
- Printing machinery

# FF2 and FF3 Series

## TECHNICAL SPECIFICATIONS

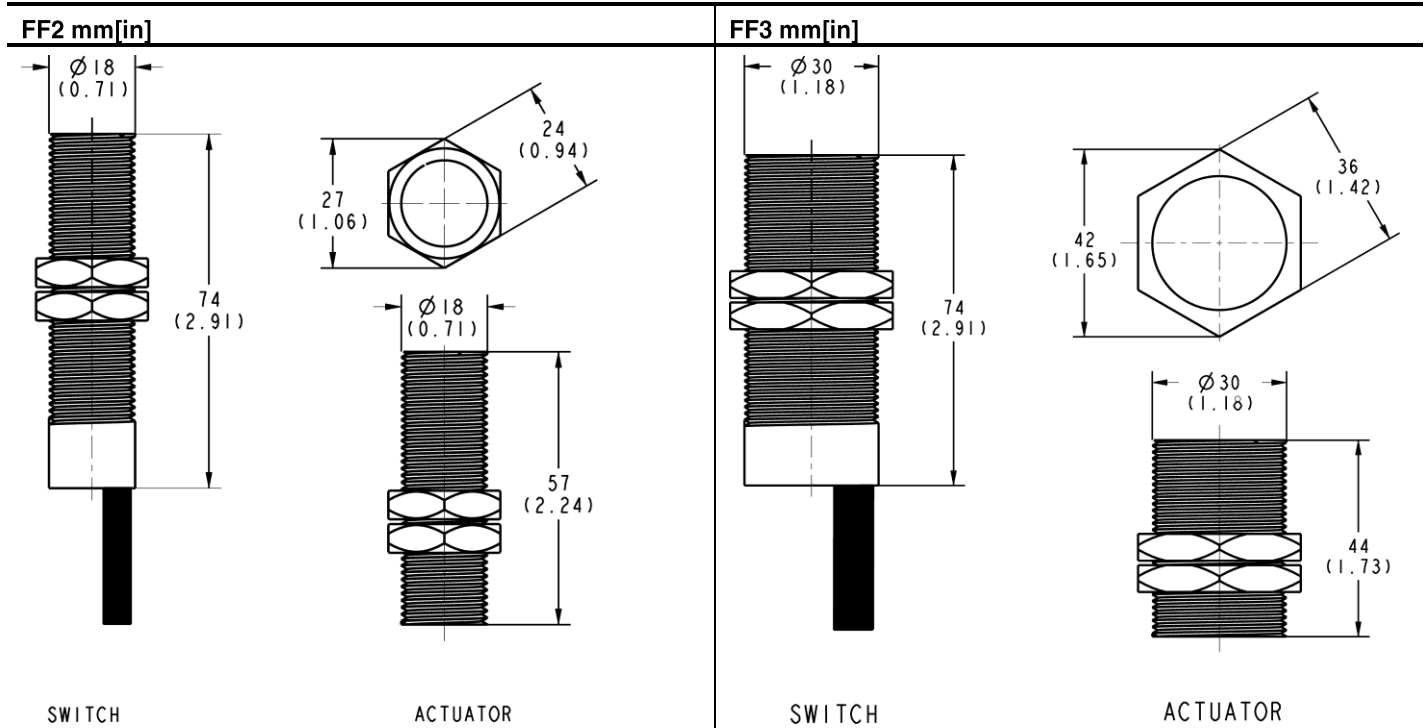

Type	FF2-10-AC FF2-11-AC	FF2-10-DC FF2-11-DC	FF3-20-AC FF3-21-AC	FF3-20-DC FF3-21-DC
Contact arrangement	1NC (FF2-10-AC) 1NC/1NO (FF2-11-AC)	1NC (FF2-10-DC) 1NC/1NO (FF2-11-DC)	2NC (FF3-20-AC) 2NC/1NO (FF3-21-AC)	2NC (FF3-20-DC) 2NC/1NO (FF3-21-DC)
Safety contact rating	230 Vac/2 A	30 Vdc/1 A inductive/ resistive	230 Vac/2A	30 Vdc/1 A inductive/ resistive
Safety contact operating distance	10 mm [0.4 in] ON; 30 mm [1.18 in] OFF	10 mm [0.4 in] ON; 30 mm [1.18 in] OFF	10 mm [0.4 in] ON; 35 mm [1.38 in] OFF	10 mm [0.4 in] ON; 35 mm [1.38 in] OFF
Safety contact close/drop/bounce	3 ms/2.1 ms/0.7 ms	3 ms/2.1 ms/0.7 ms	3 ms/2.1 ms/0.7 ms	3 ms/2.1 ms/0.7 ms
Auxiliary contact rating	15 W/10 VA	15 W/10 VA	15 W/10 VA	15 W/10 VA
Auxiliary contact operating distance	7 mm [0.28 in] OFF; 14 mm [0.55 in] ON	7 mm [0.28 in] OFF; 14 mm [0.55 in] ON	7 mm [0.28 in] OFF; 20 mm [0.79 in] ON	7 mm [0.28 in] OFF; 20 mm [0.79 in] ON
Auxiliary contact close/drop/bounce	0.5 ms/0.3 ms/0.7 ms	0.5 ms/0.3 ms/0.7 ms	0.5 ms/0.3 ms/0.7 ms	0.5 ms/0.3 ms/0.7 ms
Internal fuse	ac: 2 A fast acting	dc: 1 A fast acting	ac: 2 A fast acting	dc: 1 A fast acting
External fuse (customer supplied)	ac: 1.6 A fast acting	dc: 0.8 A fast acting	ac: 1.6 A fast acting	dc: 0.8 A fast acting
IP rating	IP67	IP67	IP67	IP67
Vibration/shock	50 Hz to 100 Hz/10 g	50 Hz to 100 Hz/10 g	50 Hz to 100 Hz/10 g	50 Hz to 100 Hz/10 g
Operating temperature	-10 °C to 55 °C [14 °F to 131 °F]	-10 °C to 55 °C [14 °F to 131 °F]	-10 °C to 55 °C [14 °F to 131 °F]	-10 °C to 55 °C [14 °F to 131 °F]
Mounting and fixture	Target to target	Target to target	Target to target	Target to target
Construction	Red ABS resin filled	Red ABS resin filled	Red ABS resin filled	Red ABS resin filled

## DIMENSIONS



# Magnetically Actuated Non-Contact Barrel Safety Switches

## CONNECTIONS

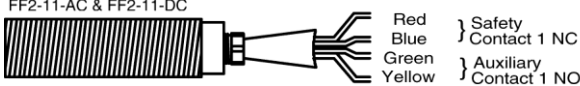
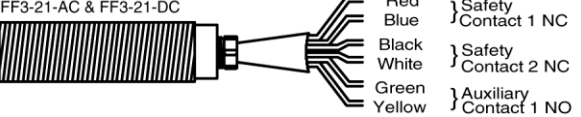
<p><b>FF2-10</b></p> <p>FF2-10-AC &amp; FF2-10-DC</p> 	<p><b>FF3-20</b></p> <p>FF3-20-AC &amp; FF3-20-DC</p> 
<p><b>FF2-11</b></p> <p>FF2-11-AC &amp; FF2-11-DC</p> 	<p><b>FF3-21</b></p> <p>FF3-21-AC &amp; FF3-21-DC</p> 

## CONTACTS

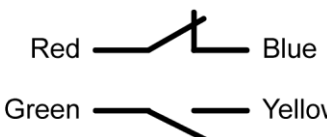
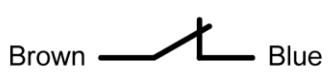
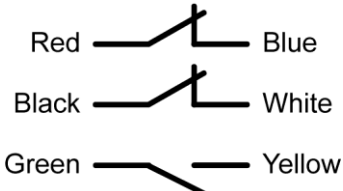
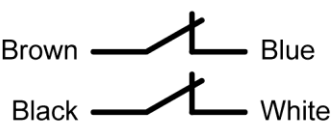
<p><b>FF2</b></p>	
<p style="text-align: center;"><b>FF2-11-AC-03</b> <b>FF2-11-DC-03</b></p> 	<p style="text-align: center;"><b>FF2-10-AC-03</b> <b>FF2-10-DC-03</b></p> 
<p><b>FF3</b></p>	
<p style="text-align: center;"><b>FF3-21-AC-03</b> <b>FF3-21-DC-03</b></p> 	<p style="text-align: center;"><b>FF3-20-AC-03</b> <b>FF3-20-DC-03</b></p> 

NOTE: Contact configurations show under closed condition for guard device.

## ORDER GUIDE

Catalog Listing	Description
FF2-10-AC-03	Barrel safety switch, 18 mm [0.70 in], 1NC, ac, 3 m pre-wired
FF2-11-AC-03	Barrel safety switch, 18 mm [0.70 in], 1NC/1NO, ac, 3 m pre-wired
FF2-10-DC-03	Barrel safety switch, 18 mm [0.70 in], 1NC, dc, 3 m pre-wired
FF2-11-DC-03	Barrel safety switch, 18 mm [0.70 in], 1NC/1NO, dc, 3 m pre-wired
FF3-20-AC-03	Barrel safety switch, 30 mm [1.18 in], 2NC, ac, 3 m pre-wired
FF3-21-AC-03	Barrel safety switch, 30 mm [1.18 in], 2NC/1NO, ac, 3 m pre-wired
FF3-20-DC-03	Barrel safety switch, 30 mm [1.18 in], 2NC, dc, 3 m pre-wired
FF3-21-DC-03	Barrel safety switch, 30 mm [1.18 in], 2NC/1NO, dc, 3 m pre-wired

### **WARNING**

#### **RISK TO LIFE OR PROPERTY**

Never use this product for an application involving serious risk to life or property without ensuring that the system as a whole has been designed to address the risks, and that this product is properly rated and installed for the intended use within the overall system.

**Failure to comply with these instructions could result in death or serious injury.**

### **WARNING**

#### **MISUSE OF DOCUMENTATION**

- The information presented in this product sheet is for reference only. Do not use this document as a product installation guide.
- Complete installation, operation, and maintenance information is provided in the instructions supplied with each product.

**Failure to comply with these instructions could result in death or serious injury.**

#### **WARRANTY/REMEDY**

Honeywell warrants goods of its manufacture as being free of defective materials and faulty workmanship. Honeywell's standard product warranty applies unless agreed to otherwise by Honeywell in writing; please refer to your order acknowledgement or consult your local sales office for specific warranty details. If warranted goods are returned to Honeywell during the period of coverage, Honeywell will repair or replace, at its option, without charge those items it finds defective. **The foregoing is buyer's sole remedy and is in lieu of all other warranties, expressed or implied, including those of merchantability and fitness for a particular purpose. In no event shall Honeywell be liable for consequential, special, or indirect damages.**

While we provide application assistance personally, through our literature and the Honeywell web site, it is up to the customer to determine the suitability of the product in the application.

Specifications may change without notice. The information we supply is believed to be accurate and reliable as of this printing. However, we assume no responsibility for its use.

#### **SALES AND SERVICE**

Honeywell serves its customers through a worldwide network of sales offices, representatives and distributors. For application assistance, current specifications, pricing or name of the nearest Authorized Distributor, contact your local sales office or:

**E-mail:** [info.sc@honeywell.com](mailto:info.sc@honeywell.com)

**Internet:** [www.honeywell.com/sensing](http://www.honeywell.com/sensing)

#### **Phone and Fax:**

Asia Pacific +65 6355-2828  
+65 6445-3033 Fax  
Europe +44 (0) 1698 481481  
+44 (0) 1698 481676 Fax  
Latin America +1-305-805-8188  
+1-305-883-8257 Fax  
USA/Canada +1-800-537-6945  
+1-815-235-6847  
+1-815-235-6545 Fax

Sensing and Control  
Honeywell  
1985 Douglas Drive North  
Golden Valley, MN 55422  
[www.honeywell.com](http://www.honeywell.com)

004748-2-EN IL50 GLO Printed in USA  
June 2009  
Copyright © 2009 Honeywell International Inc. All rights reserved.

# Honeywell

## X-ON Electronics

Largest Supplier of Electrical and Electronic Components

*Click to view similar products for [Control Switches](#) category:*

*Click to view products by [Honeywell](#) manufacturer:*

Other Similar products are found below :

[80887-99](#) [80932-99](#) [86855-00](#) [88814-30](#) [89721-12](#) [89804-08](#) [EX0011-1](#) [SSN](#) [RL01801](#) [50051857-17](#) [50099156-001-05](#) [51.155R-15200](#)  
[50058920-26](#) [KMK-PA](#) [RAL9005](#) [M16](#) [ACCU-SC/L-3000](#) [PORTAPRO](#) [CFPS-73-48M](#) [WEL.PT-O6](#) [WEL.PT-L8](#) [WEL.PT-K7](#) [WEL.PT-](#)  
[H7](#) [WEL.PT-E9](#) [WEL.PT-D7](#) [WEL.PT-B7](#) [WEL.PT-AA9](#) [WEL.PT-AA8](#) [WEL.PT-A8](#) [WEL.LT-F](#) [WEL.LT-4](#) [WEL.LT-1LX](#) [WEL.LT-1L](#)  
[WEL.ET-BB](#) [WEL.CT5B7](#) [WEL.51361699](#) [RGFRA1903041A1T](#) [PLC-60/75](#) [PLC-30/40](#) [PLC-24/30](#) [PLC-40/55](#) [LOC-MIKSER2](#) [8522808](#)  
[CC-100N](#) [V8Y-11Z-Y](#) [V8Y-11Z-R](#) [V8Y-11Z-O](#) [V8Y-11Z-24R](#) [V8Y-11Z-24O](#) [V8Y-11Z-230B](#) [V8Y-11-230W](#) [V8Y-11-230O](#)