

Cement Fixed Resistors

PRM Type

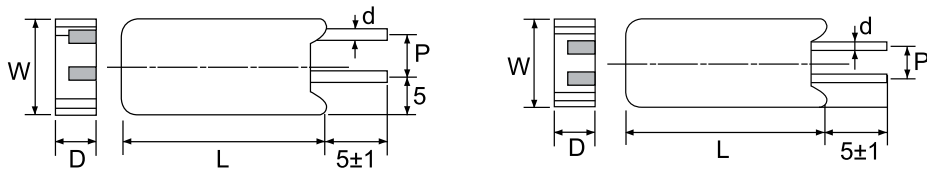

***PRM 7W, 10W : Lead not centered

*** PRM 2W, 3W, 5W,
PRMA 5W, 10W,
PRMB 7W } Lead centered

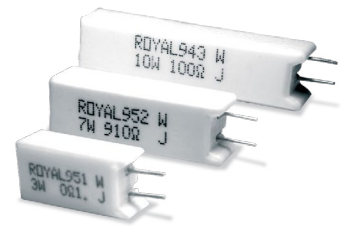

Part No.	Style	Power Rating at 70°C	Dimension (mm)					Resistance Range	
			W±1	D±1	L±1	d±0.05	P±1	Wire-wound	Power Film
PRM02W	PRM 2W	2W	11.5	7.5	20	0.75	5	0.1Ω ~ 27Ω	28Ω ~ 33KΩ
PRM03W	PRM 3W	3W	12.5	8.5	25	0.75	5	0.1Ω ~ 39Ω	40Ω ~ 56KΩ
PRM05W	PRM 5W	5W	13	9	25	0.75	5	0.1Ω ~ 47Ω	48Ω ~ 100KΩ
PRM07W	PRM 7W	7W	13	9	39	0.75	5	0.1Ω ~ 680Ω	681Ω ~ 200KΩ
PRM0AW	PRM 10W	10W	13	9	50	0.75	5	0.1Ω ~ 910Ω	911Ω ~ 200KΩ
PRMA5W	PRMA 5W	5W	13	9	25	0.75	7.5	0.1Ω ~ 47Ω	48Ω ~ 100KΩ
PRMAAW	PRMA 10W	10W	16	12	35	0.75	7.5	0.1Ω ~ 560Ω	561Ω ~ 100KΩ
PRMB7W	PRMB 7W	7W	13	9	39	0.75	5	0.1Ω ~ 680Ω	681Ω ~ 200KΩ

Remark: Max Worldrg Voltage: 500V
Max Overload Voltage: 1,000V

Heat Rise Chart (PRM)

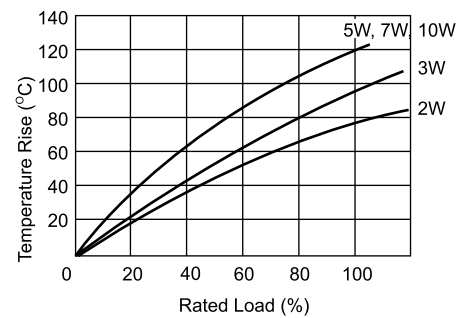

PRS Type

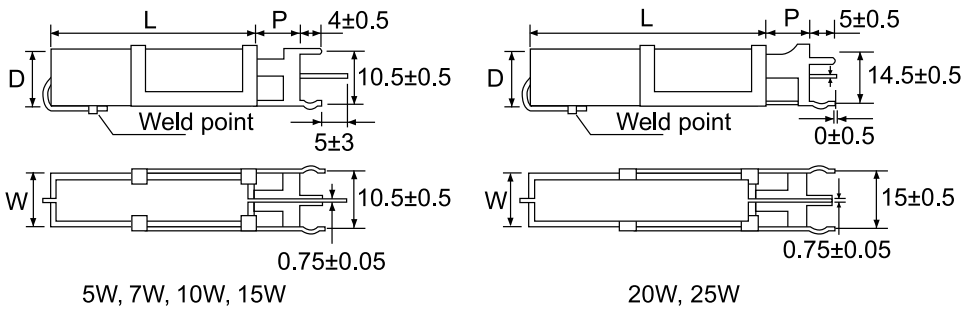

5W, 7W, 10W, 15W

20W, 25W

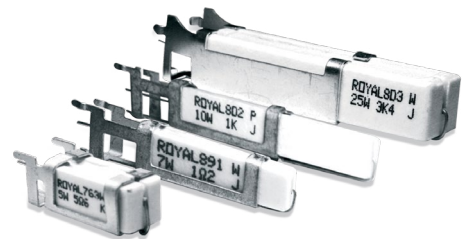

Part No.	Style	Power Rating at 70°C	Dimension (mm)					Resistance Range	
			W±1	D±1	L±1	d±0.05	P±1	Wire-wound	Power Film
PRS05W	PRS 5W	5W	10	9	22	0.75	5	0.1Ω ~ 47Ω	48Ω ~ 100KΩ
PRS07W	PRS 7W	7W	10	9	35	0.75	10	0.1Ω ~ 680Ω	681Ω ~ 200KΩ
PRS0AW	PRS 10W	10W	10	9	49	0.75	10	0.1Ω ~ 910Ω	911Ω ~ 200KΩ
PRS0FW	PRS 15W	15W	12.5	11.5	49	0.75	11	1Ω ~ 1KΩ	
PRS020	PRS 20W	20W	14.5	13.5	60	0.75	10	1Ω ~ 3.4KΩ	
PRS025	PRS 25W	25W	14.5	13.5	64	0.75	10	1Ω ~ 3.4KΩ	

Remark: Max Worldrg Voltage: 500V
Max Overload Voltage: 1,000V

Cement Fixed Resistors

PRS Recommended Hole

PRS 5W

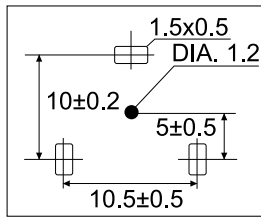

PRS 7W, 10W, 15W

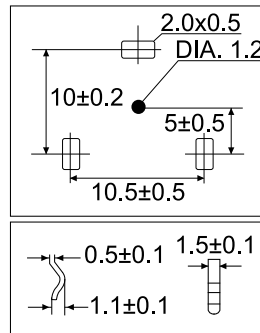

PRS 20W, 25W

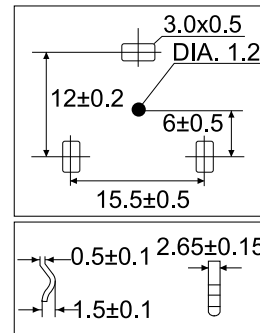

Heat Rise Chart (PRS)

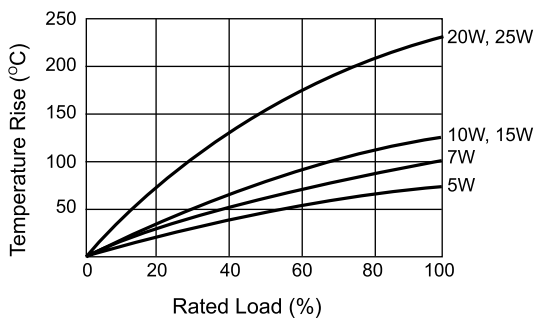

PRZA-1, PRZA-2, PRZA-3, PRZC, PRZD Type

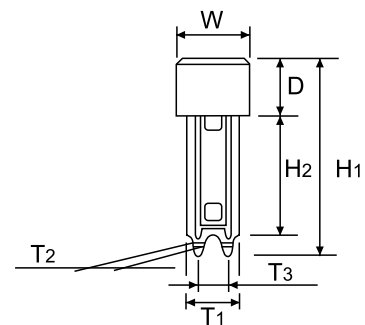
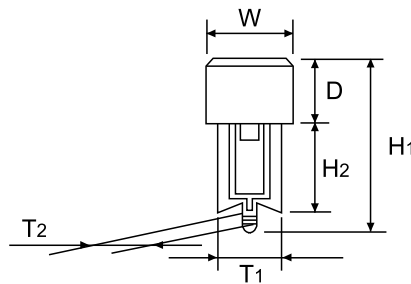
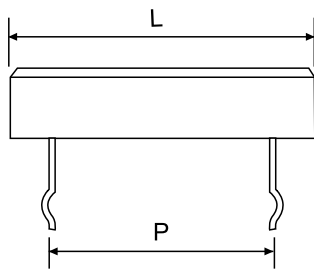

Recommended Hole

PRZA-1, PRZA-2, PRZA-3

PRZC, PRZD

Power Rating at 70°C	Dimension (mm)		
	PRZA-1, PRZA-2, PRZA-3	PRZC, PRZD	P
5W			9.5 / 15
7W			22
10W			32 / 35
15W			32
20W			45

X-ON Electronics

Largest Supplier of Electrical and Electronic Components

Click to view similar products for [Wirewound Resistors - Through Hole category](#):

Click to view products by [Royal Ohm manufacturer](#):

Other Similar products are found below :

[75822-2K4](#) [90J56R](#) [AC03000001208JAC00](#) [EP3WS47RJ](#) [C1010KJL](#) [C1015RJL](#) [C3A10KJT](#) [27J1K0](#) [ES3W47RJ](#) [AC04000001500JAC00](#)
[AC10000002208JAB00](#) [AC10000004708JAB00](#) [SQMW5R39J](#) [SQPW5R22J](#) [SQPW5R33J](#) [1879927-3](#) [FCB2100RJ](#) [T505](#) [FSQ5WR47J](#)
[FW10A33R0JA](#) [CPCC03R5000JB31](#) [CPCC0510R00JE32](#) [CPCC051R000JB31](#) [CPCP10500R0JE32](#) [CPW05700R0JE143](#)
[CPW152K500JE313](#) [C1010RJL](#) [C10R47JL](#) [C141K0JL](#) [C144R7JL](#) [ES05W100RJ](#) [SQMW1047RJ](#) [SQMW210RJ](#) [CPCC03R2000JB31](#)
[CPCC0515R00JE01](#) [CPW055R000JB143](#) [CPW103K300JE143](#) [CPW202R000JB14](#) [ULW5-39R0JT075](#) [W31-R47JA1](#) [ULW5-68RJT075](#)
[SQBW401K0JFASTON](#) [SPH1001JLF](#) [65888-3R3](#) [CPCC10R5100JE66](#) [SQP500JB-400R](#) [SQBW403R3JFASTON](#) [280-PRM7-4.7-RC](#)
[CW02B9R100JE73](#) [CPCP05R1000JE32](#)