

PR-18 series

Characteristic

PR-18 single turn potentiometers are enclosed in a metal housing, with carbon resistive element. Potentiometers have a linear characteristic of regulation, and are made in one of three versions, which differ in the type of terminals, for PCB and wire soldering. PR-18 series potentiometers may be equipped in a single-pole switch. Potentiometers with 5% and 10% resistance tolerance are available on request.

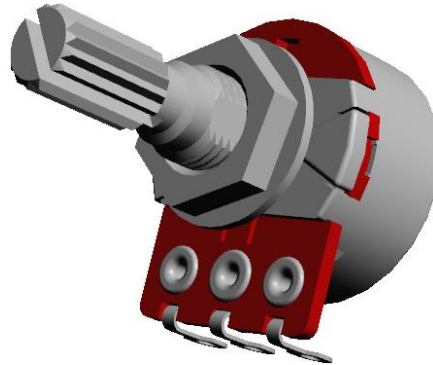

<u>Parameter</u>		<u>Value</u>
Nominal resistance		E3 series
Range of available resistances		120 Ω ... 4,7 MΩ
Resistance tolerance	$R \leq 220 \text{ k}\Omega$	$\pm 20\%$
	$R > 220 \text{ k}\Omega$	$\pm 30\%$
Max. dissipation power P_n (T = 40°C)		0,2 W
Max. load at category temperature		25% P_n
Max. operating voltage		200 V
Breakdown voltage		280 V
Mechanical rotation angle		$300^\circ \pm 5^\circ$
Switch parameters	AC	120 V / 1 A
	DC	16 V / 1 A
Climatic category		25/070/10

Shaft types

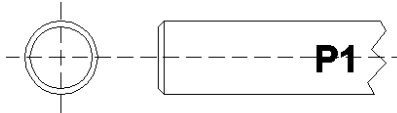
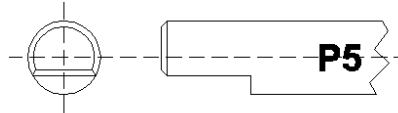
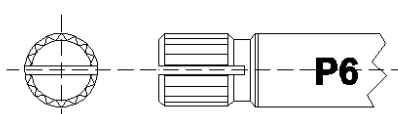
Type	Length L [mm]	
P1	16; 20; 25; 32	
P5	16; 20; 25; 32	
P6	16; 20; 25; 32	

TELPOD S.A.

str. Pilsudskiego 63A
32-050 Skawina
www.telpod.pl

Technical division: +48 (0)12 257 10 12
Sales division: +48 (0)12 257 10 35
fax: +48 (0)12 257 10 13
e-mail: potentiometer@telpod.pl

date: 04 / 2015
Copyright 2015 by Telpod

PR-18 series

Dimensions

PR ... // version with ring terminals for wire soldering

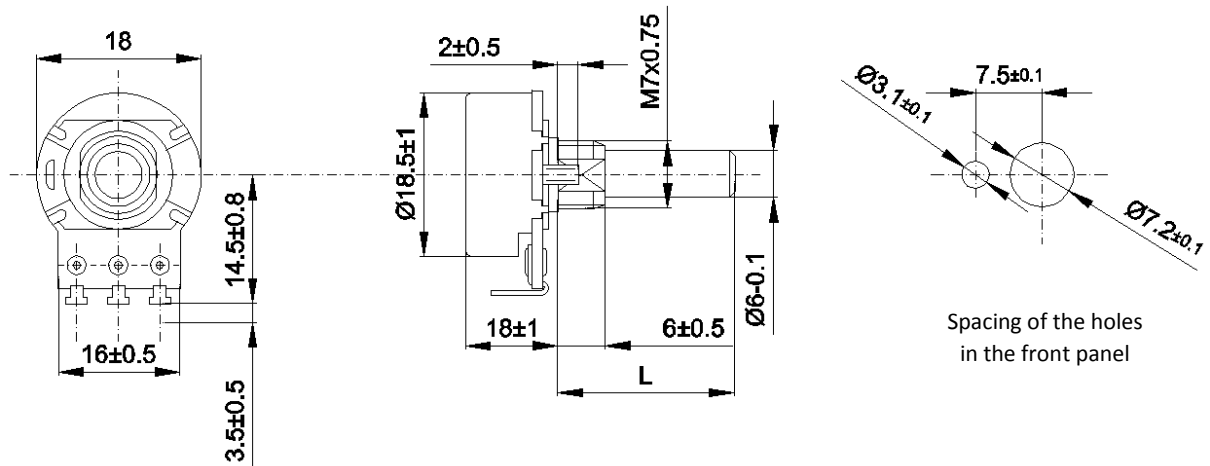

PRPC ... // version with terminals for PCB bent toward the shaft

PRP... // version with straight terminals for PCB

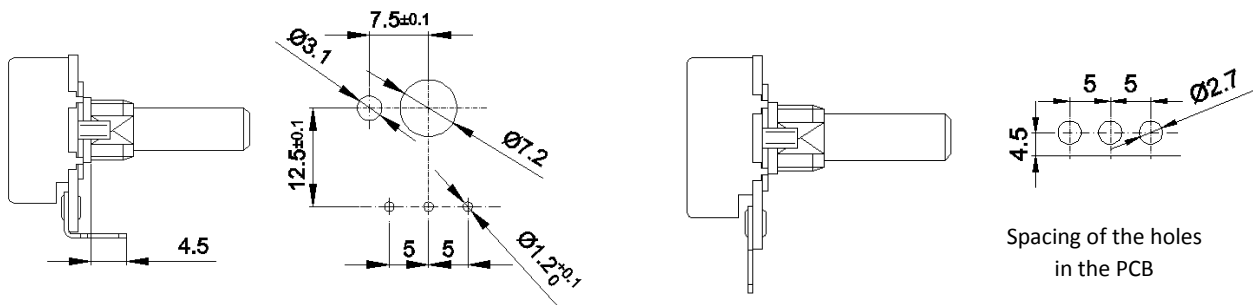

PR ... s56 // potentiometer with a single-pole switch

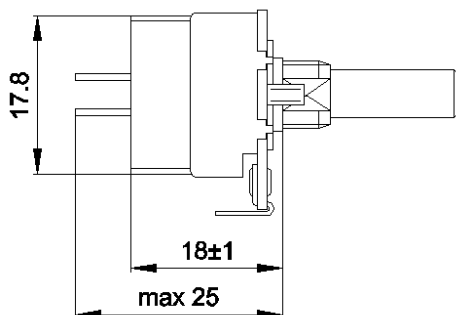

X-ON Electronics

Largest Supplier of Electrical and Electronic Components

Click to view similar products for [Trimmer Resistors - Through Hole](#) category:

Click to view products by [Telpod](#) manufacturer:

Other Similar products are found below :

[56PR250K](#) [M63M102KB30T607](#) [M63M103KB40](#) [M63M501KB40](#) [M63P102KB30T607](#) [M63P105KB30T607](#) [M63P202KB40](#)
[M63P203KB30T607](#) [M63P203KB40](#) [M63P205KB30T607](#) [M63P501KB40](#) [M63P502KB40](#) [M63S102KB40](#) [M63S103KB40](#) [M63X101KB40](#)
[M63X103KB40](#) [M63X104KB40](#) [M63X501KB40](#) [M63X503KB40](#) [M70Y102KB25](#) [76PR500K](#) [79PR5K](#) [P8PY103KB25](#) [CT6P-103](#)
[M63M102KB40](#) [M63M104KB40](#) [M63M502KB40](#) [M63P102KB40](#) [M63P103KB30T640](#) [M63P103KB40](#) [M63P104KB30T607](#)
[M63P104KB40](#) [M63P204KB40](#) [M63P504KB40](#) [M63S203KB40](#) [M63S502KB40](#) [M63X105KB40](#) [M63X502KB40](#) [M70Y203KB25](#)
[M70Y502KB25](#) [T9YA472KT20](#) [404806505008](#) [388N-100](#) [409HA102M](#) [4270W105K](#) [56PR2MEG](#) [82PR2KLFTB](#) [416MA504P](#) [SK 104](#)
[25,4 STC TO 220](#) [9702-2SL-1](#)