

# Flow Set Point Switching – RFS Types

- ▶ Combines visual confirmation of flow with dynamic, electronic switch operation
- ▶ Easy, adjustable switch point calibration: a local LED signals when set point is reached

RotorFlow® Switches build an extra level of reliability and protection into your equipment. By principle of operation, the rotor cannot be deceived into indicating a positive flow situation when no flow actually exists. Once set to a desired actuation point, RotorFlow will switch to a “no-flow” condition should the rotor stop for any reason.

## Typical Applications

Protect expensive electronic equipment from coolant flow failure on...

- Semiconductor Processing Equipment
- Lasers • Medical Equipment
- X-Ray and Other High Power Tubes
- Robotic Welding Equipment



File No. E45168



## Specifications

<b>Wetted Materials</b>	Brass, 316 Stainless Steel or Polypropylene (Hydrolytically Stable, Glass Reinforced)	
<b>Body</b>		
<b>Rotor Pin</b>	Ceramic	
<b>Rotor</b>	PPS Composite, Black	
<b>Lens</b>	Polysulfone	
<b>O-Ring</b>	Viton® (Alloy Bodies); Buna N (Polypropylene Body)	
<b>Low Flow Adaptor</b>	Glass Reinforced Polypropylene	
<b>Operating Pressure, Maximum</b>	200 PSIG (13.8 bar) @ 70°F (21°C), 100 PSIG (6.9 bar) Max. @ 212°F (100°C) <sup>1</sup>	
<b>Brass or Stainless Steel Body</b>		
<b>Polypropylene Body</b>	100 PSIG (6.9 bar) @ 70°F (21°C), 40 PSI (2.8 bar) Max. @ 180°F (82°C)	
<b>Operating Temperature,</b>	-20°F to 212°F (-29°C to 100°C)	
<b>Brass or Stainless Steel Body</b>		
<b>Polypropylene Body</b>	-20°F to 180°F (-29°C to 82°C)	
<b>Electronics</b>	150°F (65°C) Ambient	
<b>Viscosity, Maximum</b>	200 SSU	
<b>Input Power</b>	24 VDC or 115 VAC	
<b>Relay Contact Ratings (SPDT)</b>	1 Amp, 24 VDC Resistive; 0.3 Amp, 110 VAC	
<b>Current Consumption</b>	<b>No Load</b>	<b>Load (Relay Energized)</b>
<b>24 VDC</b>	20mA	35mA
<b>115 VAC</b>	45mA	95mA
<b>Repeatability</b>	2% Maximum Deviation	
<b>Set Point Accuracy (Factory Set)</b>	± 5%	
<b>Set Point Differential</b>	15% Maximum	
<b>Electrical Termination</b>	20 AWG PVC-Jacketed, 24" Cable. Color Codes: Red = +VAC/VDC, Black = Ground, White = N.O. Contact, Brown = N.C. Contact, Green = Common	

Note:

1. Optional pulsed output available with RFS. Consult factory.

## Dimensions

### Polypropylene Bodies

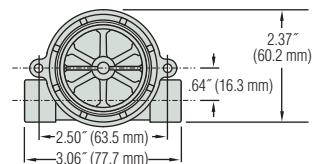

### VDC

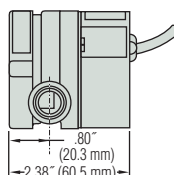

### VAC

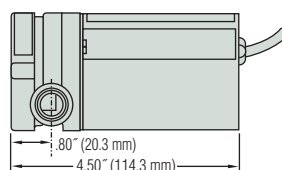

### Brass and Stainless Steel Bodies - .25" and .50" Port

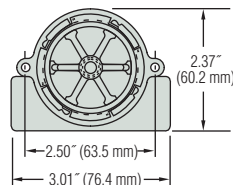

### VDC

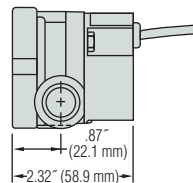

### VAC

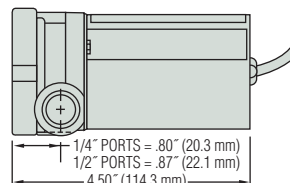

### Brass and Stainless Steel Bodies - .75" and 1.00" Port

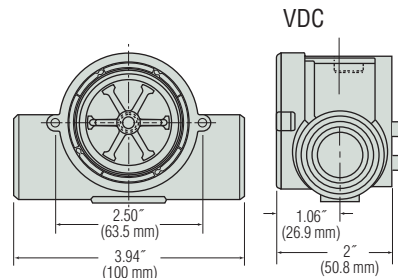

### VAC

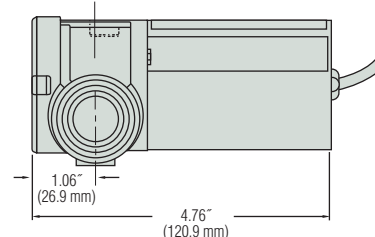

### Switch Set Point Calibration With LED Signal (RFS Type)

With the unit installed in the line and power supplied, complete the following steps to calibrate switch actuation point with proper flow rate. A small flat-blade screwdriver is the only tool required.

1. Adjust liquid flow in the line to the rate at which switch actuation is desired.
2. Insert screwdriver into opening on backside of housing and fit blade into the potentiometer adjustment screw inside.
3. If LED is not illuminated, slowly turn screwdriver counterclockwise and stop as soon as LED illuminates.
4. If LED is illuminated, turn screwdriver clockwise until LED light goes out. Then, slowly turn screwdriver counterclockwise and stop as soon as LED illuminates.

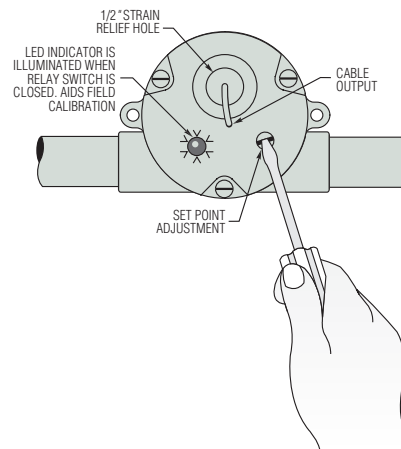

### How To Order

Specify Part Number based on desired body material, port size and input power rating.

Body Material	Port Size NPT	Flow Ranges – GPM		Input Power	Part Number
		Low Range*	Standard Range		
Polypropylene	.25"	0.1 to 1.0	0.5 to 5.0	24 VDC	<b>155425</b> ⚡
				115 VAC	<b>155876</b> ⚡
	.50"	1.5 to 12.0	4.0 to 20.0	24 VDC	<b>155485</b> ⚡
				115 VAC	<b>155886</b> ⚡
Brass	.25"	0.1 to 1.0	0.5 to 5.0	24 VDC	<b>156265</b> ⚡
				115 VAC	<b>156266</b> ⚡
	.50"	1.5 to 12.0	4.0 to 20.0	24 VDC	<b>156268</b> ⚡
				115 VAC	<b>156269</b> ⚡
	.75"	–	5.0 to 30.0	24 VDC	<b>180395</b> ⚡
				115 VAC	<b>180396</b> ⚡
	1.00"	–	8.0 to 60.0	24 VDC	<b>181688</b> ⚡
				115 VAC	<b>181689</b> ⚡
Stainless Steel	9/16-18**	0.1 to 1.0	0.5 to 5.0	24 VDC	<b>165073</b> ⚡
				115 VAC	<b>165074</b> ⚡
	.50"	1.5 to 12.0	4.0 to 20.0	24 VDC	<b>165077</b> ⚡
				115 VAC	<b>165078</b> ⚡
	.75"	–	5.0 to 30.0	24 VDC	<b>181691</b> ⚡
				115 VAC	<b>181692</b> ⚡
	1.00"	–	8.0 to 60.0	24 VDC	<b>181693</b> ⚡
				115 VAC	<b>181694</b> ⚡

\* With use of Low Flow Adapter supplied. See Page F-8 for more information.  
 \*\* Straight thread with O-ring seal.

⚡ – Stock Items.

### Special Requirements:

GEMS caters to OEM needs with special configurations for potable water and enhanced chemical capabilities. Consult factory for further details.

For higher pressure/temperature ratings, stainless face plates are available. Consult factory.

**High Resolution Black Rotor**  
 PPS composite. Each of the six rotor arms is magnetized. A PTFE loaded bushing ensures long life.



### Pressure Drop-Typical

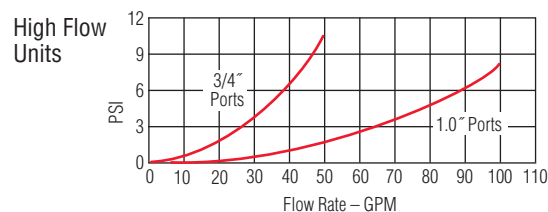
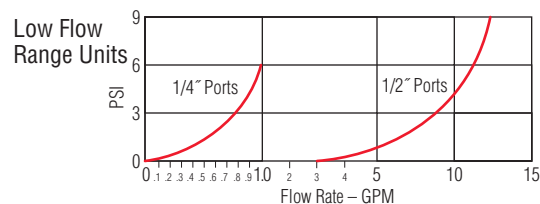
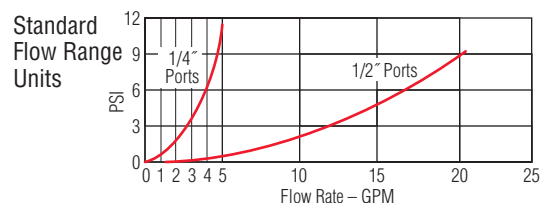

## Easy Installation and Maintenance

A proper installation will enhance RotorFlow sensor performance. Install using standard pipe fitting tools; horizontal fluid lines are recommended. For further installation and maintenance recommendations, refer to one of the following instruction bulletins: RFO Types—Part Number 157258; RFI Types—Part Number 157259; RFS Types—Part Number 157261.

Since their function is to monitor dynamic fluid flow, naturally the rotor will react to turbulence, pulsation, entrained air, and other flow anomalies induced in the flow stream by other process hardware. For optimum performance, install RotorFlow units where nominal flow conditions exist with ports located at the top. Incoming flow may be placed to either port; a minimum of 8 inches (20 cm) of straight pipe on the inlet side is required. When operating in the low flow range, the supplied Low Flow Adapter must be installed in the incoming port.

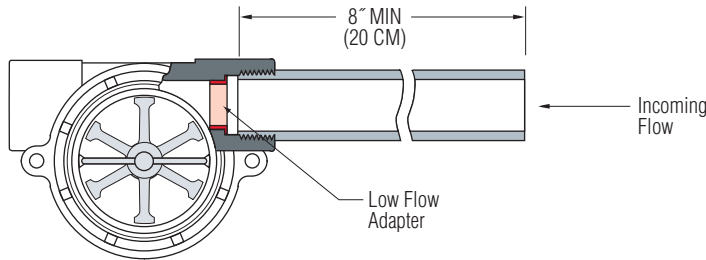

Except for straight-thread versions, RotorFlow sensors connect to piping via NPT mating thread forms. The use of an appropriate thread sealant is necessary to assure a leak-tight connection. Permatex "No More Leaks" or 2 wraps of Teflon tape are the only sealants recommended for GEMS flow sensors. Straight-thread versions require an O-ring for sealing.

150 micron filtration is recommended. However, should foreign particles enter the RotorFlow sensor, accumulation is easily cleared by removing the lens from the body. The lens is removed by turning its 7/16" hex center hub 45° counter-clockwise with a standard socket wrench. To reinstall the lens, simply reverse the process. Pressure must be relieved from the system prior to sensor clean-out. O-rings should be lubricated prior to re-assembly.

## Low Flow Applications

A low flow adapter is supplied with all Rotorflow units. It is used to produce accurate response at low flow rates. Install the adapter, as shown above, in the port selected for incoming flow.

## Panel Mounting

**Plastic Bodies.** Two (2) mounting ears are provided at the body center line to receive #8 self-tapping screws to accommodate panel mounting of the plastic RotorFlow units. Note: ANSI T type 23 self-tapping screws are recommended. They may be replaced with standard machine screws if re-installation should be required.

**Brass and Stainless Steel Bodies.** Two (2) mounting holes are provided on the body centerline, as shown below. #8-32UNC-2B screws are required for mounting.

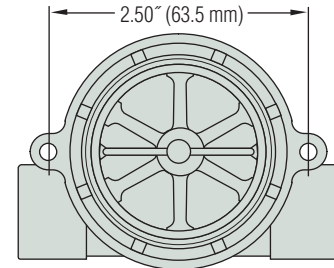

## RotorFlow® Maintenance Kits

Rebuild your RotorFlow® Sensors and Switches in less than 5 minutes with one of these kits.

Includes:

- Ceramic Rotor Pin
- 6-Pole Magnetic Rotor with PPS/PTFE Bushing
- Buna N or Viton® O-Ring
- Polysulfone Lens

Rotorflow® Type		O-Ring Material in Kit	Part Numbers	
Line Size	Body Material		RFA/RFO/RFS	RFI
1/4" & 1/2"	Plastic	Buna-N	155870 ⚡	155872
	Brass/SS	Viton®	167364 ⚡	166267
3/4" & 1"	Brass/SS	Viton®	182695	157187

⚡ – Stock Items.

## RotorFlow® Sensor Special Capabilities are Yours for the Asking.

Gems caters to OEM needs with special configurations that go beyond the standards in this catalog. We can provide RotorFlow sensors with enhanced chemical compatibility, higher temperature and pressure capabilities, and alternate electrical terminations.

Other Capabilities Available to OEMs:

- Electrical outputs: Combined switch and frequency; transistor switching; 0-10 VDC analog.
- Custom face plate (cast stainless steel face plate pictured)



We are committed to providing our customers with the product that best meets the requirements of their applications. Please call us and tell us what you need, and ask us about Swagelok® tube fittings, faceplate options, and 9/16" and 3/4" straight-thread versions.

**Call 800-378-1600**

## **X-ON Electronics**

Largest Supplier of Electrical and Electronic Components

*Click to view similar products for [Flow Sensors](#) category:*

*Click to view products by [Gems Sensors](#) manufacturer:*

Other Similar products are found below :

[VSR-3](#) [SS-12225](#) [AWM43300VH](#) [AWM730P1](#) [HAFBLF0400C5AX3](#) [FS1010-C01](#) [UF25B100](#) [FS15LF](#) [FS22A](#) [FS1012-1100-NG](#) [FS1012-1020-NG](#) [FS2012-1100-NG](#) [SFM3000-200C](#) [G-MAFCO-005](#) [SFM3000-200](#) [FPP800KIT1](#) [TDC-GP21](#) [T&R](#) [HAFBLF0100C4AX5](#) [HAFBLF0400C4AX3](#) [HAFBLF0050C4AX3](#) [SFM4100](#) [Air](#) [156268](#) [70824](#) [129660](#) [155421](#) [155481](#) [173931-C](#) [173250](#) [87480](#) [ATS-FM-22](#) [ATS-FM-34](#) [ATS-FM-44](#) [ATS-FM-66](#) [ATS-FM-M](#) [81501025](#) [81525101](#) [81526001](#) [81529003](#) [81529004](#) [81529005](#) [81529006](#) [81529007](#) [81529008](#) [81529010](#) [81529025](#) [81529901](#) [FS15A](#) [FS-90/1](#) [HAFBSS0200C2AX5](#) [AWM1200V](#)