

CEMENT FIXED RESISTORS

Features

- Self extinguishing
- Excellent flame and moisture resistance
- Extremely small sturdy and mechanically safe
- Non-inductive types available for all Royal Ohm Cement Resistors
- Too low or too high ohmic values on Wire-wound & Power Film type can be supplied on a case to case basis

Ordering Procedure: (Ex.: PRW 5W, 5%, 100Ω, B/B)

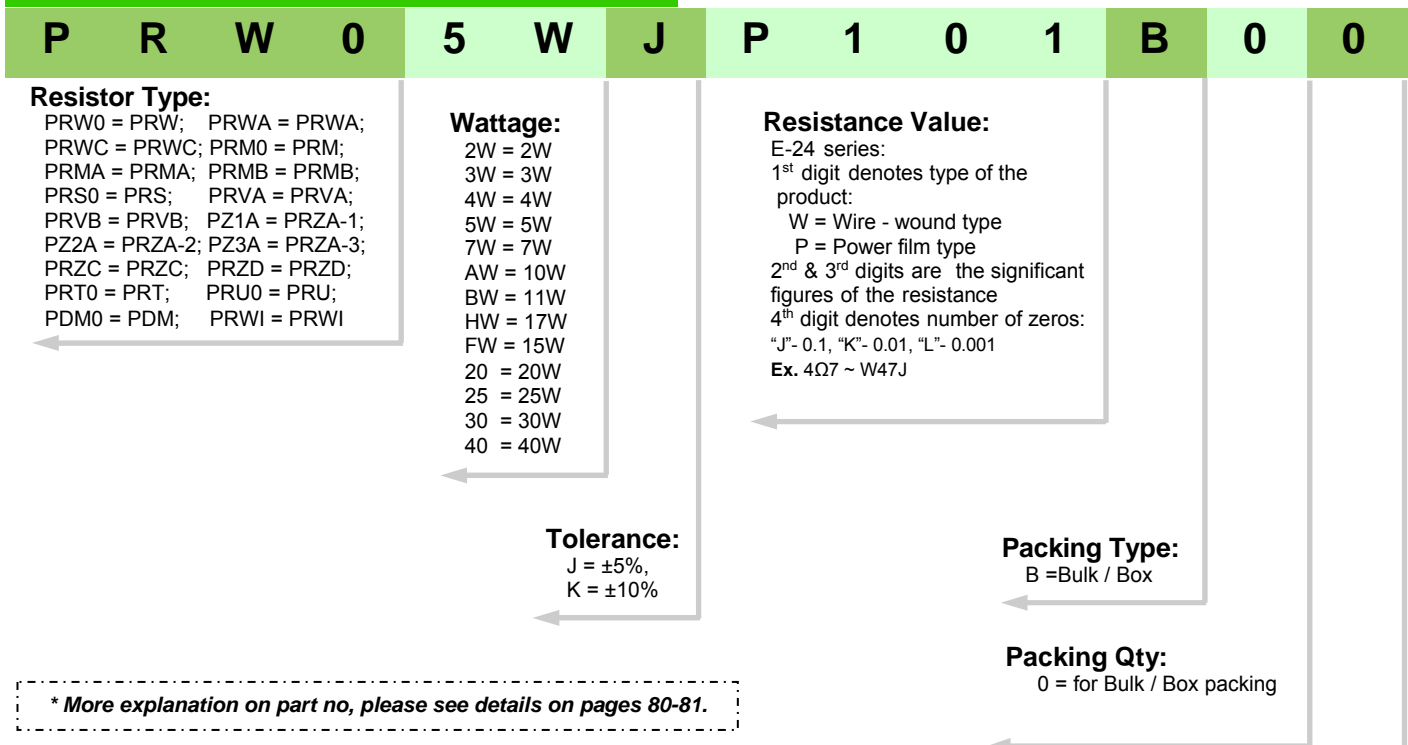

Performance Specifications

Temperature coefficient	< 20Ω: ±400PPM/°C; ≥ 20Ω: ±350PPM/°C
Short-time overload	ΔR/R ≤ ±(5.0% + 0.05Ω), with no evidence of mechanical damage.
Dielectric withstanding voltage	No evidence of flashover, mechanical damage, arcing or insulation breakdown.
Terminal strength	No evidence of mechanical damage.
Solderability	Min. 95% coverage
Temperature cycling	ΔR/R ≤ ±(2.0% + 0.05Ω), with no evidence of mechanical damage.
Humidity (Steady State)	ΔR/R ≤ ±(5.0% + 0.05Ω), with no evidence of mechanical damage.
Load life in humidity	For Wire-wound range, the ΔR/R is ±5% For Power film range, <100KΩ, the ΔR/R is ±5% For Power film range, ≥100KΩ, the ΔR/R is ±10%
Load life	For Wire-wound range, the ΔR/R is ±5% For Power film range, <100KΩ, the ΔR/R is ±5% For Power film range, ≥100KΩ, the ΔR/R is ±10%
Resistance to soldering heat	ΔR/R ±(1.0% + 0.05Ω), with no evidence of mechanical damage.

*More details, please see pages 78-79.

Special Feature:
 0 = Standard product
 I = Non-Inductive

CEMENT FIXED RESISTORS

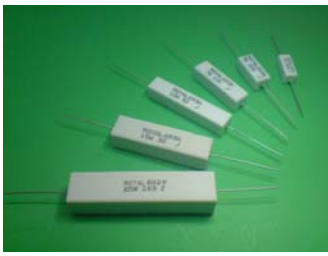

(1) PRW Type

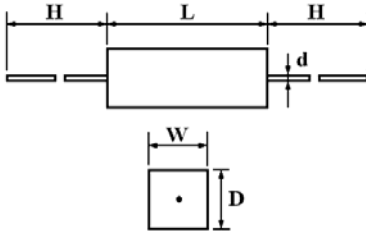

Part No.	Style	Dimension (mm)					Resistance Range	
		W ± 1	D ± 1	L ± 1	d ± 0.05	H ± 5	Wire-Wound	Power Film
PRW01W	PRW - 1W	6	6	14	0.60	25	1Ω ~ 27Ω	28Ω ~ 33KΩ
PRW02W	PRW - 2W	7	7	18	0.75	28	0.1Ω ~ 27Ω	28Ω ~ 33KΩ
PRW03W	PRW - 3W	8	8	22	0.75	32	0.1Ω ~ 39Ω	40Ω ~ 56KΩ
PRW05W	PRW - 5W	10	9	22	0.75	35	0.1Ω ~ 47Ω	48Ω ~ 100KΩ
PRW07W	PRW - 7W	10	9	35	0.75	35	0.1Ω ~ 680Ω	681Ω ~ 200KΩ
PRW0AW	PRW - 10W	10	9	49	0.75	35	0.1Ω ~ 910Ω	911Ω ~ 200KΩ
PRW0FW	PRW - 15W	12.5	11.5	49	0.75	35	1Ω ~ 1KΩ	
PRW020	PRW - 20W	14.5	13.5	60	0.75	35	2Ω ~ 1.2KΩ	
PRW025	PRW - 25W	14.5	13.5	64	0.75	35	2Ω ~ 1.2KΩ	

(1-1) PRWA Type

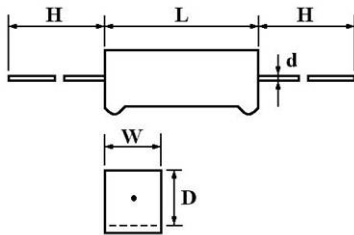

Part No.	Style	Dimension (mm)					Resistance Range	
		W ± 1	D ± 1	L ± 1	d ± 0.05	H ± 5	Wire-Wound	Power Film
PRWA2W	PRWA - 2W	7	7	18	0.75	28	0.1Ω ~ 27Ω	28Ω ~ 33KΩ
PRWA3W	PRWA - 3W	8	8	22	0.75	32	0.1Ω ~ 39Ω	40Ω ~ 56KΩ
PRWA5W	PRWA - 5W	10	9	22	0.75	35	0.1Ω ~ 47Ω	48Ω ~ 100KΩ
PRWA7W	PRWA - 7W	10	9	35	0.75	35	0.1Ω ~ 680Ω	681Ω ~ 200KΩ
PRWAAW	PRWA - 10W	10	9	49	0.75	35	0.1Ω ~ 910Ω	911Ω ~ 200KΩ

(1-2) PRWC Type

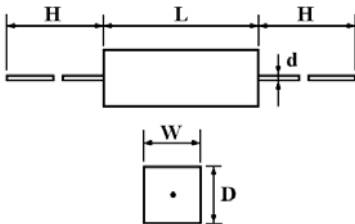

Part No.	Style	Dimension (mm)					Resistance Range	
		W ± 1	D ± 1	L ± 1	d ± 0.05	H ± 5	Wire-Wound	Power Film
PRWC1W	PRWC - 1W	5.5	5.5	12	0.60	25	1Ω ~ 27Ω	28Ω ~ 33KΩ
PRWC2W	PRWC - 2W	6	6	18	0.75	28	1Ω ~ 27Ω	28Ω ~ 33KΩ
PRWC3W	PRWC - 3W	6	6	20	0.75	28	1Ω ~ 27Ω	28Ω ~ 33KΩ
PRWC5W	PRWC - 5W	6	6	25	0.75	35	1Ω ~ 200Ω	201Ω ~ 100KΩ
PRWC7W	PRWC - 7W	9	9	25	0.75	35	1Ω ~ 200Ω	201Ω ~ 100KΩ

Derating Curve

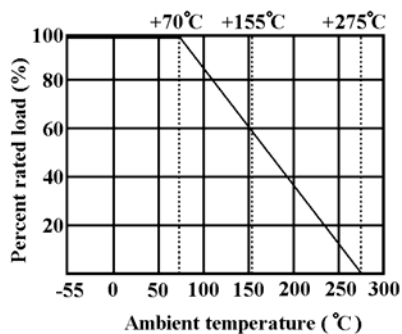

Heat Rise Chart

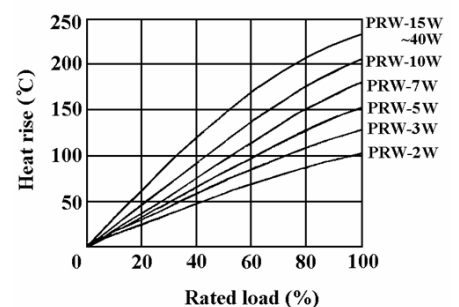

CEMENT FIXED RESISTORS

(2) PRM Type

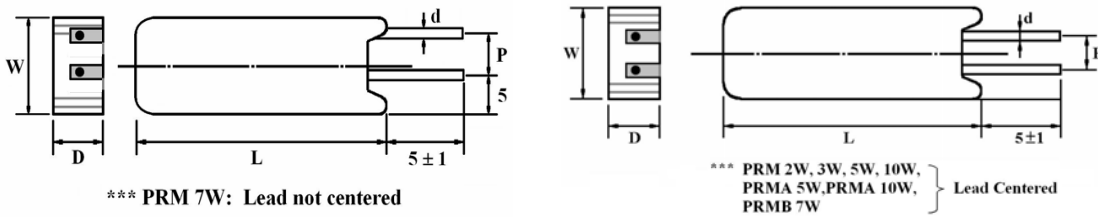

Heat Rise Chart

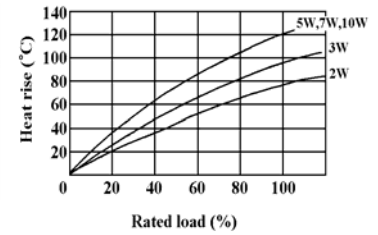

Part No.	Style	Dimension (mm)					Resistance Range	
		W ± 1	D ± 1	L ± 1	d ± 0.05	P ± 1	Wire-Wound	Power Film
PRM02W	PRM-2W	11.5	7.5	20	0.75	5	0.1Ω ~ 27Ω	28Ω ~ 33KΩ
PRM03W	PRM-3W	12.5	8.5	25	0.75	5	0.1Ω ~ 39Ω	40Ω ~ 56KΩ
PRM05W	PRM-5W	12.5	9	25	0.75	5	0.1Ω ~ 47Ω	48Ω ~ 100KΩ
PRM07W	PRM-7W	12.5	9	38	0.75	5	0.1Ω ~ 680Ω	681Ω ~ 200KΩ
PRM0AW	PRM-10W	12.5	9	50	0.75	5	0.1Ω ~ 910Ω	911Ω ~ 200KΩ
PRMA5W	PRMA-5W	12.5	9	25	0.75	7.5	0.1Ω ~ 47Ω	48Ω ~ 100KΩ
PRMAAW	PRMA-10W	16	12	35	0.75	7.5	0.1Ω ~ 560Ω	561Ω ~ 100KΩ
PRMB7W	PRMB-7W	12.5	9	38	0.75	5	0.1Ω ~ 680Ω	681Ω ~ 200KΩ



(3) PRS Type



Derating Curve

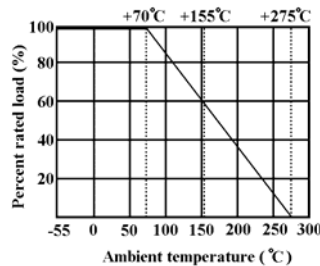

Heat Rise Chart

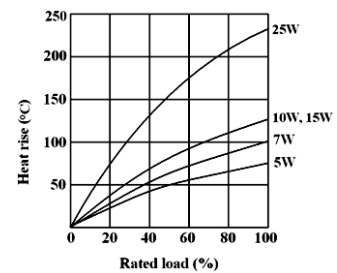

Part No.	Style	Dimension (mm) ± 1				Resistance Range	
		W	D	L	P	Wire-wound	Power Film
PRS05W	PRS-5W	10	9	22	5	0.1Ω ~ 47Ω	48Ω ~ 100KΩ
PRS07W	PRS-7W	10	9	35	10	0.1Ω ~ 680Ω	681Ω ~ 200KΩ
PRS0AW	PRS-10W	10	9	49	10	0.1Ω ~ 910Ω	911Ω ~ 200KΩ
PRS0FW	PRS-15W	12.5	11.5	49	11	1Ω ~ 1KΩ	
PRS020	PRS-20W	14.5	13.5	60	10	1Ω ~ 3.4KΩ	
PRS025	PRS-25W	14.5	13.5	64	10	1Ω ~ 3.4KΩ	

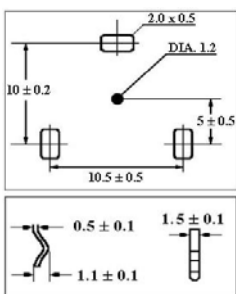

Recommended Hole
7W, 10W, 15W

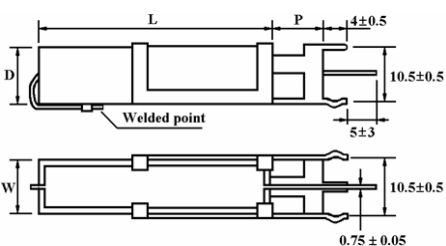

***PRS 5W, 7W, 10W, 15W

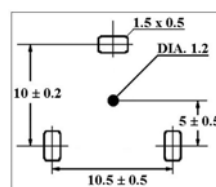

Recommended Hole
5W

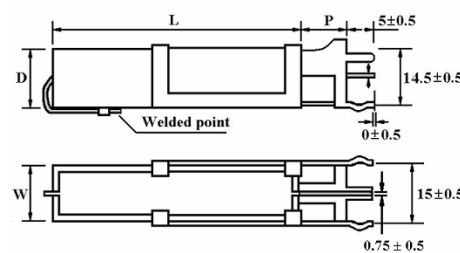

***PRS 20W, 25W

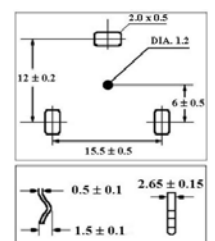

Recommended Hole
20W, 25W

CEMENT FIXED RESISTORS

(4) PRZA-1, PRZA-2, PRZA-3, PRZC, PRZD Type

PRZA-1, PRZA-2, PRZA-3, PRZC, PRZD

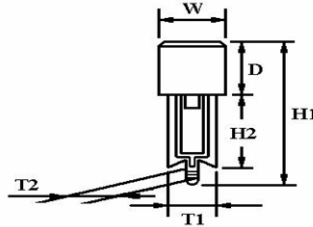
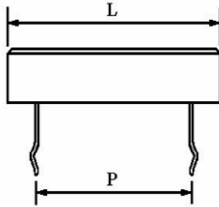

PRZC, PRZD

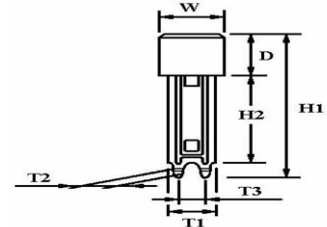

Recommendable Hole

Power Rating at 70°C	Dimension (mm)		P
	PRZA-1, PRZA-2, PRZA-3	PRZC, PRZD	
5W			9.5 / 15
7W			22
10W			32 / 35
15W			32
20W			45

CEMENT FIXED RESISTORS

Dimension (mm)

Part No.	Power Rating at 70°C	Type	Dimension (mm)									Resistance Range	
			W ± 1	D ± 1	L	P ± 1.5	T ₁ ± 1	T ₂ ± 0.2	T ₃ ± 0.5	H ₁ ⁺² / ₋₁	H ₂ ⁺² / ₋₁	Wire-wound	Power Film
PZ1A5W	5W	PRZA-1	10	9	25 ± 1	9.5	7	1.6		24	10	0.1 Ω ~ 120 Ω	121 Ω ~ 56 K Ω
					27 ± 1	15							
PZ2A5W		PRZA-2	10	9	27 ± 1	15	7	1.6		39	25		
PZ3A5W		PRZA-3	10	9	27 ± 1	15	7	1.3		39	25		
PRZC5W		PRZC	10	9	27 ± 1	*15	7	1.5	3.5	36	22		
PRZD5W	PRZD	10	9	27 ± 1	15	7	1.5	3.5	24	10			
PZ1A7W	7W	PRZA-1	10	9	35 ± 1	22	7	1.6		24	10	0.1 Ω ~ 560 Ω	561 Ω ~ 100 K Ω
PZ2A7W		PRZA-2	10	9	35 ± 1	22	7	1.6		39	25		
PRZC7W		PRZC	10	9	35 ± 1	*22	7	1.5	3.5	36	22		
PRZD7W		PRZD	10	9	35 ± 1	22	7	1.5	3.5	24	10		
PZ1AAW	10W	PRZA-1	10	9	48 ± 1.5	32 / 35	7	1.6		24	10	1 Ω ~ 820 Ω	821 Ω ~ 100 K Ω
PZ2AAW		PRZA-2	10	9	48 ± 1.5	32 / 35	7	1.6		39	25		
PRZCAW		PRZC	10	9	48 ± 1.5	*32 / *35	7	1.5	3.5	36	22		
PRZDAW		PRZD	10	9	48 ± 1.5	32 / 35	7	1.5	3.5	24	10		
PZ1AFW	15W	PRZA-1	12.5	11.5	48 ± 1.5	32	10	3		35	15	1 Ω ~ 1 K Ω	
PZ2AFW		PRZA-2	12.5	11.5	48 ± 1.5	32	10	3		47	30		
PRZCFW		PRZC	12.5	11.5	48 ± 1.5	*32	10	2	5	47	30		
PZ1A20	20W	PRZA-1	12.5	13.5	63 ± 1.5	45	10	3		35	15	2 Ω ~ 1.2 K Ω	
PZ2A20		PRZA-2	12.5	13.5	63 ± 1.5	45	10	3		47	30		
PRZC20		PRZC	12.5	13.5	63 ± 1.5	*45	10	2	5	47	30		

*PRZC Type Pitch Tolerance = +2 ~ +6

(5) PRVA Type

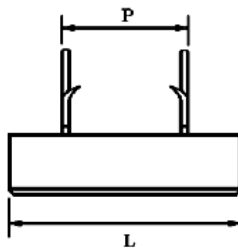
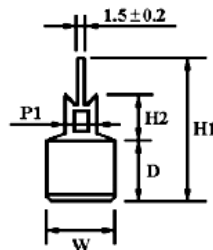

Heat Rise Chart (PRVA / PRVB)

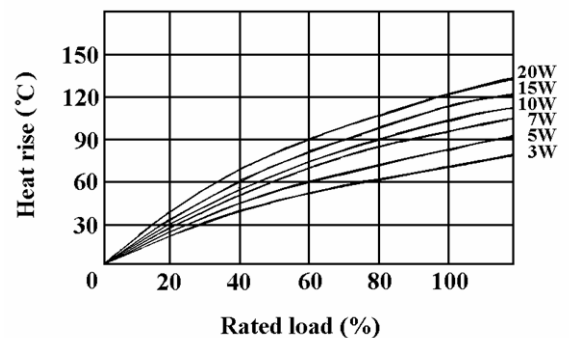

(6) PRVB Type

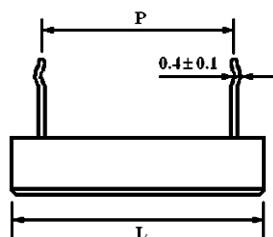
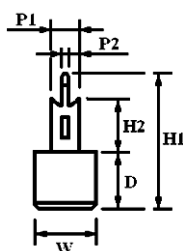

CEMENT FIXED RESISTORS

Part No.	Power Rating at 70°C	Dimension (mm) ± 1								Resistance Range	
		W	D	L	P	P ₁	H ₁	H ₂	*P ₂ ± 0.2	Wire-wound	Power Film
PRVA3W/PRVB3W	3W	10.0	9.0	22	9.5	5	25.0	10.5	1.3	0.1Ω ~ 47Ω	48Ω ~ 33KΩ
PRVA5W/PRVB5W	5W	10.0	9.0	27 / 25	15 / 9.5	5	25.0	10.5	1.3	0.1Ω ~ 120Ω	121Ω ~ 56KΩ
PRVA7W/PRVB7W	7W	10.0	9.0	35	22	5	25.0	10.5	1.3	0.1Ω ~ 560Ω	561Ω ~ 100KΩ
PRVAAW/PRVBAW	10W	10.0	9.0	48	35 / 32	5	25.0	10.5	1.3	1Ω ~ 820Ω	821Ω ~ 100KΩ
PRVAFW/PRVBFW	15W	12.5	11.5	48	32	5	27.5	10.5	1.5	1Ω ~ 1KΩ	
PRVA20/PRVB20	20W	12.5	13.5	63	45	5	29.5	10.5	1.5	1Ω ~ 1.2KΩ	

*P₂ for PRVB

(7) PRT Type

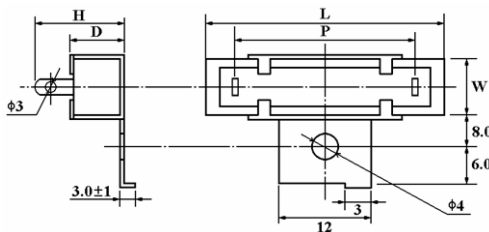

Heat Rise Chart (PRT)

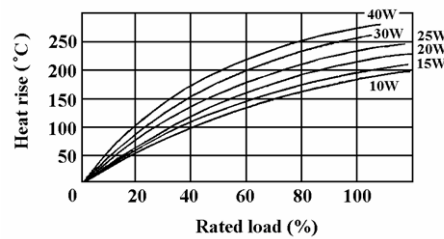

Derating Curve

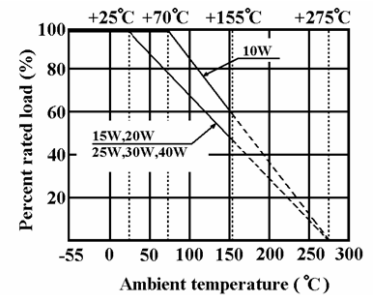

Part No.	Style	Power Rating at 70°C	Dimension (mm) ± 1						Resistance Range	
			W	D	L	P	H	T	Wire-wound	Power Film
PRT0AW	PRT - 10W	10W	10	9	48	32	18	12	1Ω ~ 820Ω	821Ω ~ 100KΩ
PRT0FW	PRT - 15W	15W	12.5	11.5	48	32	21	12	1Ω ~ 1KΩ	
PRT020	PRT - 20W	20W	12.5	13.5	63	45	21	12	2Ω ~ 1.2KΩ	
PRT030	PRT - 30W	30W	19	19	75	56	32 Max	18	3Ω ~ 1.5KΩ	
PRT040	PRT - 40W	40W	19	19	90	70	32 Max	18	6Ω ~ 1.5KΩ	

(8) PRU Type

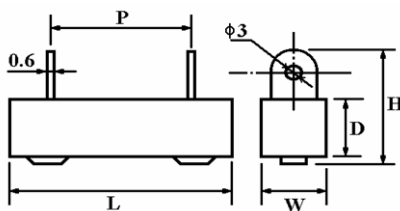

Part No.	Style	Power Rating at 70°C	Dimension (mm) ± 1					Resistance Range	
			W	D	L	P	H	Wire-Wound	Power Film
PRU0AW	PRU - 10W	10W	10.0	9	48	32	18	1Ω ~ 820Ω	821Ω ~ 100KΩ
PRU0FW	PRU - 15W	15W	12.5	11.5	48	32	21	1Ω ~ 1KΩ	
PRU020	PRU - 20W	20W	12.5	13.5	63	45	21	2Ω ~ 1.2KΩ	
PRU030	PRU - 30W	30W	19.0	19	75	56	32 Max.	3Ω ~ 1.5KΩ	
PRU040	PRU - 40W	40W	19.0	19	90	70	32 Max.	6Ω ~ 1.5KΩ	

CEMENT FIXED RESISTORS

Features

- Vertical or Axial type
- Available in 4W, 7W, 11W & 17W
- Can withstand high overload current
- Non flammable
- Extremely small, sturdy and mechanically safe
- Special solvent resistance



PRWI SERIES

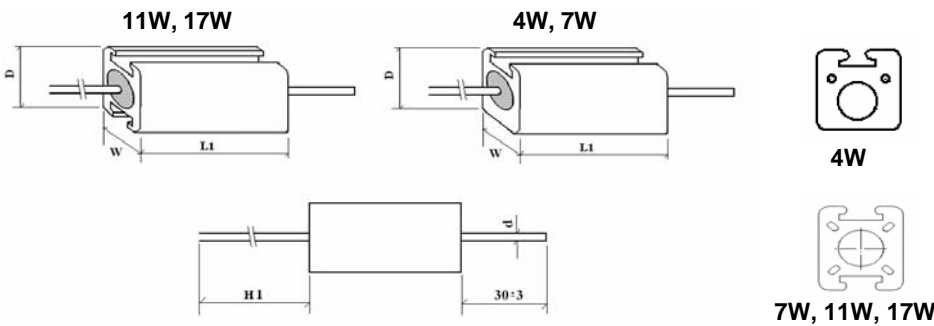

Derating curve:

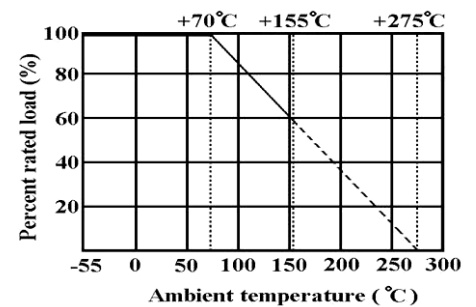

Dimension (mm)

Type	Power Rating at 70°C	W ± 1	D ± 1.5	L1 ± 1	H1 ± 5	d ± 0.05	Low Resistance Range	Standard Resistance Range	High Resistance Range
PRWI 4W	4W	7	8	20	56	0.75	0.1Ω ~ 0.9Ω	1Ω ~ 1KΩ	1.1KΩ ~ 6.8KΩ
PRWI 7W	7W	7	8	38	70	0.75	0.33Ω ~ 0.9Ω	1Ω ~ 10KΩ	10.1KΩ ~ 22KΩ
PRWI 11W	11W	9	10	50	85	0.75	0.56Ω ~ 0.9Ω	1Ω ~ 10KΩ	10.1KΩ ~ 23KΩ
PRWI 17W	17W	9	10	75	110	0.75	1Ω ~ 9.9Ω	10Ω ~ 10KΩ	10.1KΩ ~ 39KΩ

Performance Specifications

Temperature coefficient	± 400PPM/°C depends on resistance value.
Short-time overload	± (5.0% + 0.05Ω) Max, with no evidence of mechanical damage.
Dielectric withstanding voltage	No evidence of flashover, mechanical damage, arcing or insulation break down.
Terminal strength	No evidence of mechanical damage.
Solderability	Min.95% coverage
Load life in humidity	± (5.0% + 0.05Ω) Max, with no evidence of mechanical damage.
Load life	± (5.0% + 0.05Ω) Max, with no evidence of mechanical damage.
Resistance to solder heat	± (1.0% + 0.05Ω) Max, with no evidence of mechanical damage.

* More details, please see pages 78-79.

*Ordering procedure is same as Cement Fixed Resistors (page 36)

X-ON Electronics

Largest Supplier of Electrical and Electronic Components

Click to view similar products for [Wirewound Resistors - SMD category:](#)

Click to view products by [Royal Ohm manufacturer:](#)

Other Similar products are found below :

[SMW5120RJT](#) [SMW518RJT](#) [SMW524RJT](#) [SMW52R2JT](#) [SMW530RJT](#) [WSM24R99FLFTR](#) [RWS5 R47 J B](#) [RWS5 R68 F B](#) [SMW516RJT](#)
[SMW52R7JT](#) [SMW57R5JT](#) [SMW5R33JT](#) [SMW5R39JT](#) [SMW551RJT](#) [SMW5R11JT](#) [RWS5 82R F B](#) [RWS5 1R F B](#) [RWS5 120R F B](#)
[RWS5 10R F B](#) [RWS5 100R J B](#) [SMW51R2JT](#) [SMW512RJT](#) [ACS-10S-15R-J](#) [PRZDAWJW101B00](#) [SMW3300RJT](#) [RW7S0FB180RJET](#)
[RW5S0FA470RJET](#) [RW7S0FB4K70JET](#) [RW7S0FB4K70FET](#) [RWS5 1R J B](#) [RWS5 33R J B](#) [QL0000J0100200](#) [QL0000J0220200](#)
[QL0000J0470100](#) [QL0000J047J100](#) [QL0050J0362000](#) [QL0050J0470000](#) [R100W-10R](#) [R100W-22R](#) [R100W-4R7](#) [R150W-470R](#)
[HEWRB0J0220600](#) [R200W-22R](#) [R50W-10R](#) [R50W-22R](#) [R50W-2R2](#) [R80W-47R](#) [SMW5R51JT](#) [SMW5R36JT](#) [SMW5R24JT](#)