

# Digital Temperature Controller

## E5□C/E5□C-T

**E5□C Series That Pursues Greater Visibility with Large White PV Display. Models with Push-In Plus Terminal Blocks That Reduce Wiring Work, DIN Track-mounting Models That Are Ideal for Connecting to PLCs, Plug-in Models That Are Convenient for Maintenance, and Programmable Models for a Wider Range of Application. A Wide Lineup of Models to Meet a Wide Range of User Needs.**

### Digital Temperature Controllers: E5□C Series

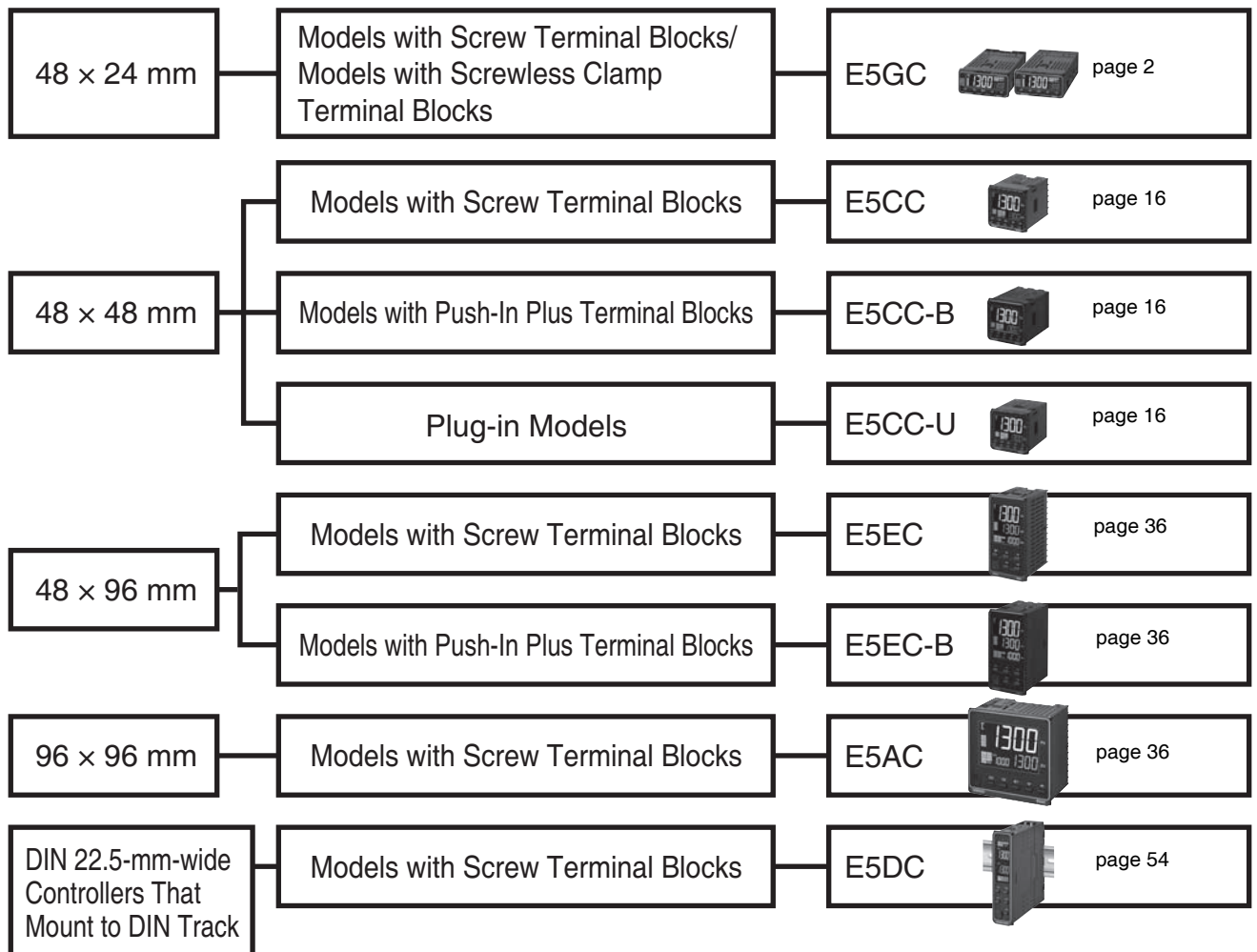

### Programmable Digital Temperature Controllers: E5□C-T Series

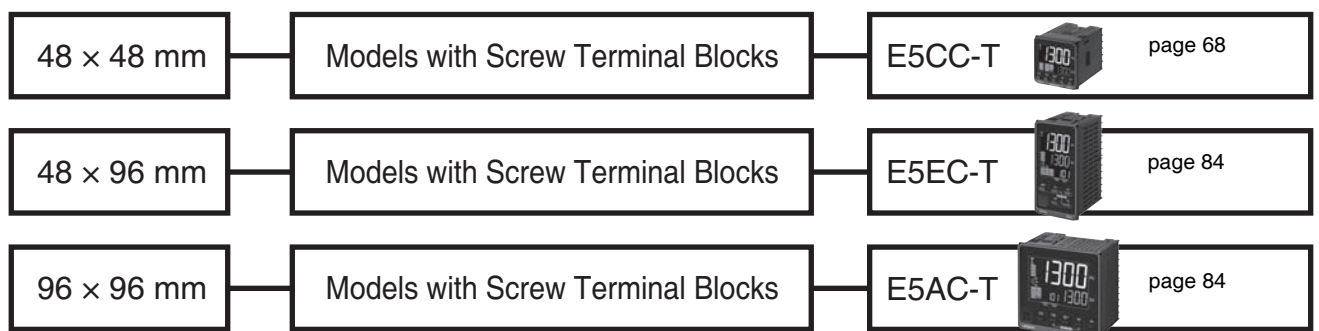

# Digital Temperature Controller

# E5GC (48 × 24 mm)

## Easy Operation and High Performance of the E5□C Series in a Compact 48 × 24-mm Body

- A compact body of 48 × 24 × 90 mm (W × H × D) that is ideal for small equipment, laboratory instruments, and others.
- White PV display with a height of 10.5 mm for high visibility even with the compact body.
- Removable terminal block to simplify maintenance. Select from screw terminal blocks or screwless clamp terminal blocks for the wiring method.
- High-speed sampling at 50 ms.
- Easy connections to a PLC with programless communications.
- Set up the Controller without wiring the power supply by connecting to the computer with a Communications Conversion Cable (sold separately). Setup is easy with the CX-Thermo (sold separately).



48 × 24 mm  
Models with Screw  
Terminal Blocks  
E5GC-□6

48 × 24 mm  
Models with Screwless  
Clamp Terminal Blocks  
E5GC-□C

Refer to your OMRON website for the most recent information on applicable safety standards.

Refer to *Safety Precautions* on 108.

## Main I/O Functions

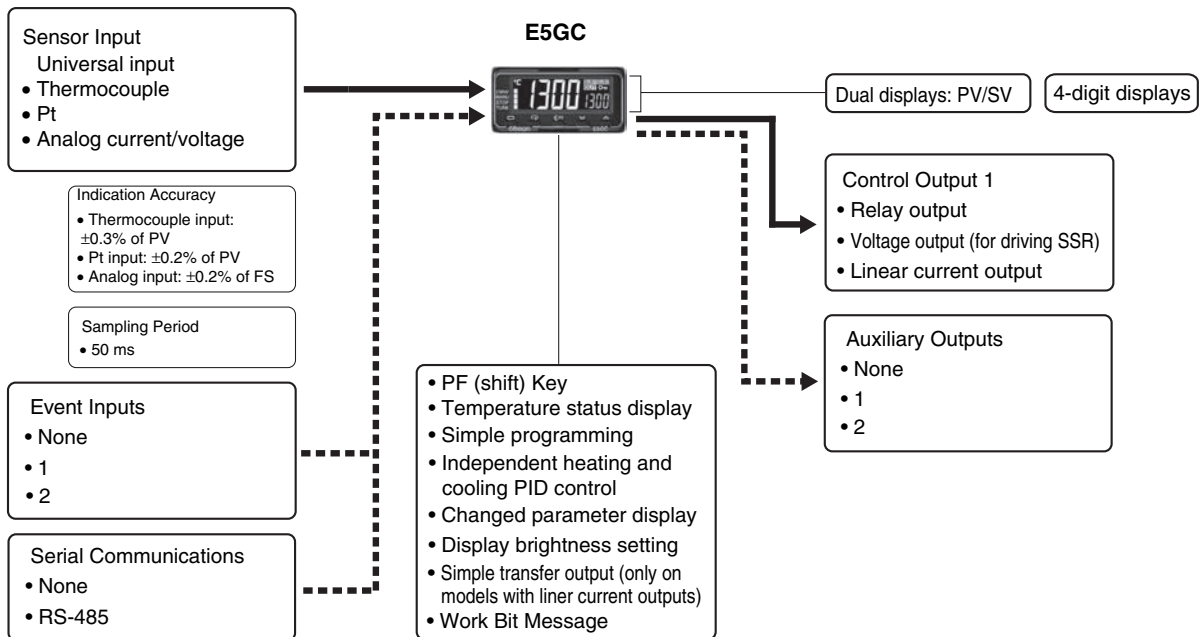

This datasheet is provided as a guideline for selecting products.

Be sure to refer to the following manuals for application precautions and other information required for operation before attempting to use the product.

E5□C Digital Temperature Controllers User's Manual (Cat. No. H174)

E5□C Digital Temperature Controllers Communications Manual (Cat. No. H175)

## Model Number Legend and Standard Models

### Model Number Legend

E5GC-□□ □ □ □ M-□□□□ (Example: E5GC-RX1A6M-015)

① ② ③ ④ ⑤ ⑥

| Model | ①                       | ②                        | ③                    | ④             | ⑤          | ⑥       | Meaning                            |                         |                     |
|-------|-------------------------|--------------------------|----------------------|---------------|------------|---------|------------------------------------|-------------------------|---------------------|
|       | Control outputs 1 and 2 | No. of auxiliary outputs | Power supply voltage | Terminal type | Input type | Options |                                    |                         |                     |
| E5GC  |                         |                          |                      |               |            |         | 48 × 24 mm                         |                         |                     |
|       |                         |                          |                      |               |            |         | <b>Control output 1</b>            | <b>Control output 2</b> |                     |
|       | RX                      |                          |                      |               |            |         | Relay output                       | None                    |                     |
|       | QX                      |                          |                      |               |            |         | Voltage output (for driving SSR)   | None                    |                     |
| *1    | CX                      |                          |                      |               |            |         | Linear current output              | None                    |                     |
|       | *2                      | 0                        |                      |               |            |         | None                               |                         |                     |
|       |                         | 1                        |                      |               |            |         | 1                                  |                         |                     |
|       |                         | 2                        |                      |               |            |         | 2                                  |                         |                     |
|       |                         |                          | A                    |               |            |         | 100 to 240 VAC                     |                         |                     |
|       |                         |                          | D                    |               |            |         | 24 VAC/DC                          |                         |                     |
|       |                         |                          |                      | 6             |            |         | Screw terminal blocks (with cover) |                         |                     |
|       |                         |                          |                      | C             |            |         | Screwless clamp terminal blocks *6 |                         |                     |
|       |                         |                          |                      |               | M          |         | Universal input                    |                         |                     |
|       |                         |                          |                      |               |            |         | <b>HB alarm and HS alarm</b>       | <b>Communications</b>   | <b>Event inputs</b> |
|       |                         |                          |                      |               |            | 000     | ---                                | ---                     | ---                 |
|       |                         |                          |                      |               |            | 015     | ---                                | RS-485                  | ---                 |
|       |                         |                          |                      |               | *3         | 016     | ---                                | ---                     | 1                   |
|       |                         |                          |                      |               | *3, *4     | 023     | 1                                  | ---                     | ---                 |
|       |                         |                          |                      |               | *5         | 024     | ---                                | ---                     | 2                   |

\*1. The control output can be used as a simple transfer output.

\*2. Only option 000 can be selected if an auxiliary output is zero.

\*3. Option 016 and 023 can be selected only if two auxiliary outputs are selected.

\*4. Option with HB and HS alarms (023) cannot be selected if a linear current output is selected for the control output.

\*5. Option 024 can be selected only if one auxiliary output is selected.

\*6. The specifications are different for Temperature Controllers with Push-In Plus terminal blocks. Refer to *Precautions when Wiring* on page 114.

## Heating and Cooling Control

### Using Heating and Cooling Control

#### ① Control Output Assignment

An auxiliary output is used as the cooling control output.

#### ② Control

If PID control is used, you can set PID control separately for heating and cooling.

This allows you to handle control systems with different heating and cooling response characteristics.

## Optional Products (Order Separately)

### USB-Serial Conversion Cable

| Model     |
|-----------|
| E58-CIFQ2 |

### Communications Conversion Cable

| Model       |
|-------------|
| E58-CIFQ2-E |

**Note:** Always use this product together with the E58-CIFQ2. This Cable is used to connect to the bottom-panel Setup Tool port.

### Current Transformers (CTs)

| Hole diameter | Model   |
|---------------|---------|
| 5.8 mm        | E54-CT1 |
| 12.0 mm       | E54-CT3 |

### Mounting Adapter

| Model          |
|----------------|
| Y92F-53 (2pcs) |

**Note:** This Mounting Adapter is provided with the Digital Temperature Controller.

### Waterproof Packing

| Model    |
|----------|
| Y92S-P12 |

**Note:** This Waterproof Packing is provided with the Digital Temperature Controller.

### Draw-out Jig

| Model   |
|---------|
| Y92F-55 |

### CX-Thermo Support Software

| Model       |
|-------------|
| EST2-2C-MV4 |

**Note:** CX-Thermo version 4.62 or higher is required for the E5GC. For the system requirements for the CX-Thermo, refer to information on the EST2-2C-MV4 on the OMRON website ([www.ia.omron.com](http://www.ia.omron.com)).

## Specifications

### Ratings

|                                      |   |   |
|--------------------------------------|---|---|
| <b>Power supply voltage</b>          | A in model number: 100 to 240 VAC, 50/60 Hz<br>D in model number: 24 VAC, 50/60 Hz; 24 VDC  |   |
| <b>Operating voltage range</b>       | 85 to 110% of rated supply voltage  |   |
| <b>Power consumption</b>             | 5.9 VA max. at 100 to 240 VAC, and 3.2 VA max. at 24 VAC or 1.8 W max. at 24 VDC  |   |
| <b>Sensor input</b>                  | Temperature input<br>Thermocouple: K, J, T, E, L, U, N, R, S, B, W, or PL II<br>Platinum resistance thermometer: Pt100 or JPt100<br>Infrared temperature sensor (ES1B): 10 to 70°C, 60 to 120°C, 115 to 165°C, or 140 to 260°C<br>Analog input<br>Current input: 4 to 20 mA or 0 to 20 mA<br>Voltage input: 1 to 5 V, 0 to 5 V, or 0 to 10 V  |   |
| <b>Input impedance</b>               | Current input: 150 Ω max., Voltage input: 1 MΩ min. (Use a 1:1 connection when connecting the ES2-HB/THB.)  |   |
| <b>Control method</b>                | ON/OFF control or 2-PID control (with auto-tuning)  |   |
| <b>Control output</b>                | <b>Relay output</b>   | SPST-NO, 250 VAC, 2 A (resistive load), electrical life: 100,000 operations, minimum applicable load: 5 V, 10 mA (reference value)                    |
|                                      | <b>Voltage output (for driving SSR)</b>   | Output voltage 12 VDC ±20% (PNP), max. Load current: 21 mA, with short-circuit protection circuit   |
|                                      | <b>Linear current output</b>  | 4 to 20 mA DC/0 to 20 mA DC, load: 500 Ω max., resolution: Approx. 10,000   |
| <b>Auxiliary output</b>              | <b>Number of outputs</b>  | 1 or 2 (depends on model)   |
|                                      | <b>Output specifications</b>  | SPST-NO relay outputs, 250 VAC, 2 A (resistive load),<br>Electrical life: 100,000 operations, Minimum applicable load: 10 mA at 5 V (reference value) |
| <b>Event input</b>                   | <b>Number of inputs</b>   | 1 or 2 (depends on model)   |
|                                      | <b>External contact input specifications</b>  | Contact input ON: 1 kΩ max., OFF: 100 kΩ min.   |
|                                      |   | Non-contact input ON: Residual voltage 1.5 V max.; OFF: Leakage current 0.1 mA max.<br>Current flow: approx. 7 mA per contact                         |
| <b>Setting method</b>                | Digital setting using front panel keys  |   |
| <b>Indication method</b>             | 11-segment digital displays and individual indicators<br>Character height: PV: 10.5 mm, SV: 5.0 mm  |   |
| <b>Multi SP</b>                      | Up to eight set points (SP0 to SP7) can be saved and selected using the event inputs, key operations, or serial communications. *   |   |
| <b>Bank switching</b>                | None  |   |
| <b>Other functions</b>               | Manual output, heating/cooling control, loop burnout alarm, SP ramp, other alarm functions, heater burnout (HB) alarm (including SSR failure (HS) alarm), 40% AT, 100% AT, MV limiter, input digital filter, self tuning, robust tuning, PV input shift, run/stop, protection functions, extraction of square root, MV change rate limit, logic operations, temperature status display, simple programming, moving average of input value, display brightness setting, simple transfer output, and work bit message |   |
| <b>Ambient operating temperature</b> | -10 to 55°C (with no condensation or icing), For 3-year warranty: -10 to 50°C with standard mounting (with no condensation or icing)  |   |
| <b>Ambient operating humidity</b>    | 25 to 85%   |   |
| <b>Storage temperature</b>           | -25 to 65°C (with no condensation or icing)   |   |
| <b>Altitude</b>                      | 2,000 m max.  |   |
| <b>Recommended fuse</b>              | T2A, 250 VAC, time-lag, low-breaking capacity   |   |
| <b>Installation environment</b>      | Overvoltage category II, Pollution Degree 2 (EN/IEC/UL 61010-1)   |   |

\* There are up to four event inputs.

## Input Ranges

### Thermocouple/Platinum Resistance Thermometer (Universal inputs)

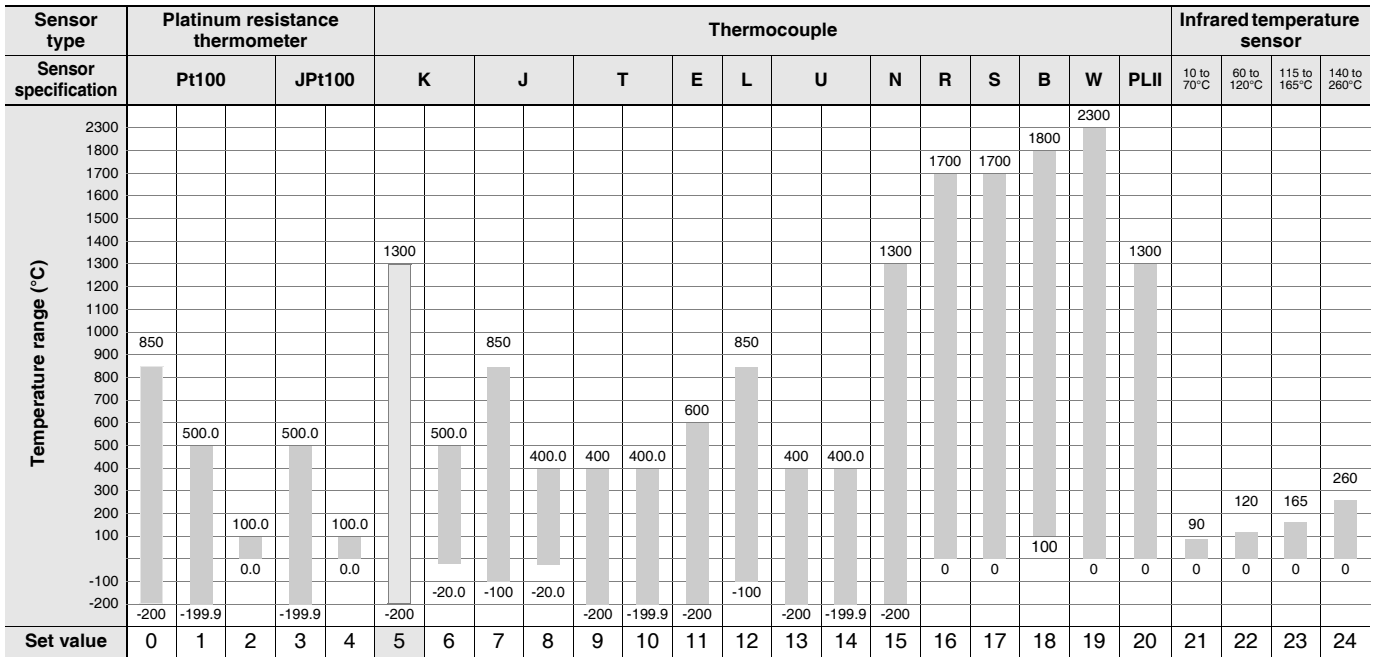

Shaded settings are the default settings.

The applicable standards for the input types are as follows:

K, J, T, E, N, R, S, B: JIS C 1602-1995, IEC 60584-1

JPt100: JIS C 1604-1989, JIS C 1606-1989

L: Fe-CuNi, DIN 43710-1985

Pt100: JIS C 1604-1997, IEC 60751

U: Cu-CuNi, DIN 43710-1985

PL II: According to Platinel II electromotive force charts from BASF (previously Engelhard)

W: W5Re/W26Re, ASTM E988-1990

### Analog input

| Input type          | Current   |            | Voltage  |          |           |
|---------------------|---|------------|----------|----------|-----------|
| Input specification | 4 to 20 mA  | 0 to 20 mA | 1 to 5 V | 0 to 5 V | 0 to 10 V |
| Setting range       | Usable in the following ranges by scaling:<br>-1999 to 9999, -199.9 to 999.9,<br>-19.99 to 99.99 or -1.999 to 9.999 |            |          |          |           |
| Set value           | 25  | 26         | 27       | 28       | 29        |

## Alarm Types

Each alarm can be independently set to one of the following 17 alarm types. The default is 2: Upper limit. (See note.)

Auxiliary outputs are allocated to alarms. ON delays and OFF delays (0 to 999 s) can also be specified.

**Note:** In the default settings for models with HB or HS alarms, alarm 1 is set to a heater alarm (HA) and the Alarm Type 1 parameter is not displayed. To use alarm 1, set the output assignment to alarm 1.

| Set value   | Alarm type                                       | Alarm output operation                   |   | Description of function  |
|-------------|--|--|---|--|
|             |  | When alarm value X is positive           | When alarm value X is negative                    |  |
| 0           | Alarm function OFF                               | Output OFF                               |   | No alarm   |
| 1           | Upper- and lower-limit *1                        |  | *2  | Set the upward deviation in the set point for the alarm upper limit (H) and the lower deviation in the set point for the alarm lower limit (L). The alarm is ON when the PV is outside this deviation range. |
| 2 (default) | Upper-limit                                      |  |   | Set the upward deviation in the set point by setting the alarm value (X). The alarm is ON when the PV is higher than the SP by the deviation or more.  |
| 3           | Lower-limit                                      |  |   | Set the downward deviation in the set point by setting the alarm value (X). The alarm is ON when the PV is lower than the SP by the deviation or more.   |
| 4           | Upper- and lower-limit range *1                  |  | *3  | Set the upward deviation in the set point for the alarm upper limit (H) and the lower deviation in the set point for the alarm lower limit (L). The alarm is ON when the PV is inside this deviation range.  |
| 5           | Upper- and lower-limit with standby sequence *1  | *5<br>                                   | *4  | A standby sequence is added to the upper- and lower-limit alarm (1). *6  |
| 6           | Upper-limit with standby sequence                |  |   | A standby sequence is added to the upper-limit alarm (2). *6   |
| 7           | Lower-limit with standby sequence                |  |   | A standby sequence is added to the lower-limit alarm (3). *6   |
| 8           | Absolute-value upper-limit                       |  |   | The alarm will turn ON if the process value is larger than the alarm value (X) regardless of the set point.  |
| 9           | Absolute-value lower-limit                       |  |   | The alarm will turn ON if the process value is smaller than the alarm value (X) regardless of the set point.   |
| 10          | Absolute-value upper-limit with standby sequence |  |   | A standby sequence is added to the absolute-value upper-limit alarm (8). *6  |
| 11          | Absolute-value lower-limit with standby sequence |  |   | A standby sequence is added to the absolute-value lower-limit alarm (9). *6  |
| 12          | LBA (alarm 1 type only)                          | -  |   | *7   |
| 13          | PV change rate alarm                             | -  |   | *8   |
| 14          | SP absolute-value upper-limit alarm              |  |   | This alarm type turns ON the alarm when the set point (SP) is higher than the alarm value (X).   |
| 15          | SP absolute-value lower-limit alarm              |  |   | This alarm type turns ON the alarm when the set point (SP) is lower than the alarm value (X).  |
| 16          | MV absolute-value upper-limit alarm *9           | Standard Control<br>                     | Standard Control<br>                              | This alarm type turns ON the alarm when the manipulated variable (MV) is higher than the alarm value (X).  |
|             |  | Heating/Cooling Control (Heating MV)<br> | Heating/Cooling Control (Heating MV)<br>Always ON |  |
| 17          | MV absolute-value lower-limit alarm *9           | Standard Control<br>                     | Standard Control<br>                              | This alarm type turns ON the alarm when the manipulated variable (MV) is lower than the alarm value (X).   |
|             |  | Heating/Cooling Control (Cooling MV)<br> | Heating/Cooling Control (Cooling MV)<br>Always ON |  |

\*1. With set values 1, 4, and 5, the upper- and lower-limit values can be set independently for each alarm type, and are expressed as "L" and "H."

\*2. Set value: 1, Upper- and lower-limit alarm

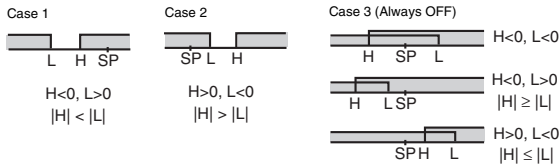

\*3. Set value: 4, Upper- and lower-limit range

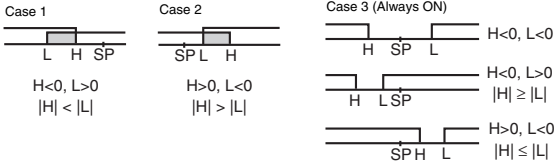

\*4. Set value: 5, Upper- and lower-limit with standby sequence For Upper- and Lower-Limit Alarm Described Above at \*2

- In cases 1 and 2 above, the alarm is always OFF if the upper- and lower-limit hysteresis overlaps.
- In case 3, the alarm is always OFF.

\*5. Set value: 5, Upper- and lower-limit alarm with standby sequence The alarm is always OFF if upper- and lower-limit hysteresis overlaps.

\*6. Refer to the *E5GC Digital Temperature Controllers User's Manual* (Cat. No. H174) for information on the operation of the standby sequence.

\*7. Refer to the *E5GC Digital Temperature Controllers User's Manual* (Cat. No. H174) for information on the LBA.

\*8. Refer to the *E5GC Digital Temperature Controllers User's Manual* (Cat. No. H174) for information on the PV change rate alarm.

\*9. When heating/cooling control is performed, the MV absolute-value upper-limit alarm functions only for the heating operation and the MV absolute-value lower-limit alarm functions only for the cooling operation.



## Characteristics

|   |                            |  |
|---|----------------------------|--|
| <b>Indication accuracy (at the temperature of 23°C)</b> |                            | Thermocouple: ( $\pm 0.3\%$ of indication value or $\pm 1^\circ\text{C}$ , whichever is greater) $\pm 1$ digit max.*1<br>Platinum resistance thermometer: ( $\pm 0.2\%$ of indication value or $\pm 0.8^\circ\text{C}$ , whichever is greater) $\pm 1$ digit max.<br>Analog input: $\pm 0.2\%$ FS $\pm 1$ digit max.<br>CT input: $\pm 5\%$ FS $\pm 1$ digit max.                        |
| <b>Simple transfer output accuracy</b>                  |                            | $\pm 0.3\%$ FS max.*2  |
| <b>Influence of temperature *3</b>                      |                            | Thermocouple input (R, S, B, W, PL II): ( $\pm 1\%$ of indication value or $\pm 10^\circ\text{C}$ , whichever is greater) $\pm 1$ digit max.<br>Other thermocouple input: ( $\pm 1\%$ of indication value or $\pm 4^\circ\text{C}$ , whichever is greater) $\pm 1$ digit max. *4   |
| <b>Influence of voltage *3</b>                          |                            | Platinum resistance thermometer: ( $\pm 1\%$ of indication value or $\pm 2^\circ\text{C}$ , whichever is greater) $\pm 1$ digit max.<br>Analog input: $\pm 1\%$ FS $\pm 1$ digit max.  |
| <b>Influence of EMS. (at EN 61326-1)</b>                |                            | CT input: $\pm 5\%$ FS $\pm 1$ digit max.  |
| <b>Input sampling period</b>                            |                            | 50 ms  |
| <b>Hysteresis</b>                                       |                            | Temperature input: 0.1 to 999.9°C or °F (in units of 0.1°C or °F)<br>Analog input: 0.01% to 99.99% FS (in units of 0.01% FS)   |
| <b>Proportional band (P)</b>                            |                            | Temperature input: 0.1 to 999.9°C or °F (in units of 0.1°C or °F)<br>Analog input: 0.1% to 999.9% FS (in units of 0.1% FS)   |
| <b>Integral time (I)</b>                                |                            | 0 to 9999 s (in units of 1 s), 0.0 to 999.9 s (in units of 0.1 s) *5   |
| <b>Derivative time (D)</b>                              |                            | 0 to 9999 s (in units of 1 s), 0.0 to 999.9 s (in units of 0.1 s) *5   |
| <b>Proportional band (P) for cooling</b>                |                            | Temperature input: 0.1 to 999.9°C or °F (in units of 0.1°C or °F)<br>Analog input: 0.1% to 999.9% FS (in units of 0.1% FS)   |
| <b>Integral time (I) for cooling</b>                    |                            | 0 to 9999 s (in units of 1 s), 0.0 to 999.9 s (in units of 0.1 s) *5   |
| <b>Derivative time (D) for cooling</b>                  |                            | 0 to 9999 s (in units of 1 s), 0.0 to 999.9 s (in units of 0.1 s) *5   |
| <b>Control period</b>                                   |                            | 0.1, 0.2, 0.5, 1 to 99 s (in units of 1 s)   |
| <b>Manual reset value</b>                               |                            | 0.0% to 100.0% (in units of 0.1%)  |
| <b>Alarm setting range</b>                              |                            | -1,999 to 9,999 (decimal point position depends on input type)   |
| <b>Influence of signal source resistance</b>            |                            | Thermocouple: 0.1°C/Ω max. (100 Ω max.), Platinum resistance thermometer: 0.1°C/Ω max. (10 Ω max.)   |
| <b>Insulation resistance</b>                            |                            | 20 MΩ min. (at 500 VDC)  |
| <b>Dielectric strength</b>                              |                            | 100 to 240 VAC: 3,000 VAC, 50/60 Hz for 1 min between terminals of different charge<br>24 VAC/DC: 2,300 VAC, 50/60 Hz for 1 min between terminals of different charge  |
| <b>Vibration</b>  | <b>Malfunction</b>         | 10 to 55 Hz, 20 m/s <sup>2</sup> for 10 min each in X, Y and Z directions  |
|   | <b>Resistance</b>          | 10 to 55 Hz, 20 m/s <sup>2</sup> for 2 hr each in X, Y, and Z directions   |
| <b>Shock</b>  | <b>Malfunction</b>         | 100 m/s <sup>2</sup> , 3 times each in X, Y, and Z directions  |
|   | <b>Resistance</b>          | 300 m/s <sup>2</sup> , 3 times each in X, Y, and Z directions  |
| <b>Weight</b>   |                            | Controller: Approx. 80 g, Adapter: Approx. 4 g × 2   |
| <b>Degree of protection</b>                             |                            | Front panel: IP66, Rear case: IP20, Terminals: IP00  |
| <b>Memory protection</b>                                |                            | Non-volatile memory (number of writes: 1,000,000 times)  |
| <b>Setup Tool</b>                                       |                            | CX-Thermo version 4.62 or higher   |
| <b>Setup Tool port</b>                                  |                            | E5GC side panel: An E58-CIFQ2 USB-Serial Conversion Cable is used to connect a USB port on the computer. *6<br>E5GC bottom panel: An E58-CIFQ2 USB-Serial Conversion Cable and E58-CIFQ2-E Conversion Cable are used together to connect a USB port on the computer. *6  |
| <b>Standards</b>  | <b>Approved standards</b>  | cULus: UL 61010-1/CSA C22.2 No.61010-1, Korean wireless regulations (Radio law: KC Mark) (Some models only.) *7  |
|   | <b>Conformed standards</b> | EN 61010-1 (IEC 61010-1)   |
| <b>EMC</b>  |                            | EMI:<br>Radiated Interference Electromagnetic Field Strength: EN61326-1 *8<br>Noise Terminal Voltage: EN55011 Group 1, class A<br>EMS:<br>ESD Immunity: EN61326-1 *8<br>Electromagnetic Field Immunity: EN61000-4-2<br>Burst Noise Immunity: EN61000-4-3<br>Conducted Disturbance Immunity: EN61000-4-4<br>Surge Immunity: EN61000-4-5<br>Voltage Dip/Interrupting Immunity: EN61000-4-6 |

\*1. The indication accuracy of K thermocouples in the -200 to 1,300°C range, T and N thermocouples at a temperature of -100°C max., and U and L thermocouples at any temperature is  $\pm 2^\circ\text{C} \pm 1$  digit max. The indication accuracy of B thermocouples at a temperature of 400°C max. is not specified. The indication accuracy of B thermocouples at a temperature of 400 to 800°C is  $\pm 3^\circ\text{C}$  max.

The indication accuracy of R and S thermocouples at a temperature of 200°C max. is  $\pm 3^\circ\text{C} \pm 1$  digit max. The indication accuracy of W thermocouples is ( $\pm 0.3\%$  of PV or  $\pm 3^\circ\text{C}$ , whichever is greater)  $\pm 1$  digit max.

The indication accuracy of PLII thermocouples is ( $\pm 0.3\%$  of PV or  $\pm 2^\circ\text{C}$ , whichever is greater)  $\pm 1$  digit max.

\*2. However, the precision between 0 and 4 mA for a 0 to 20 mA output is  $\pm 1\%$  FS max.

\*3. Ambient temperature: -10°C to 23°C to 55°C, Voltage range: -15% to 10% of rated voltage

\*4. K thermocouple at -100°C max.:  $\pm 10^\circ\text{C}$  max.

\*5. The unit is determined by the setting of the Integral/Derivative Time Unit parameter.

\*6. External serial communications (RS-485) and USB-Serial Conversion Cable communications can be used at the same time.

\*7. Refer to your OMRON website for the most recent information on applicable models.

\*8. Industrial electromagnetic environment (EN/IEC 61326-1 Table 2)

## USB-Serial Conversion Cable

|                               |  |
|-------------------------------|--|
| Applicable OS                 | Windows XP/Vista/7/8/10 *1   |
| Applicable software           | CX-Thermo version 4.62 or higher   |
| Applicable models             | E5□C-T Series, E5□C Series, and E5CB Series  |
| USB interface standard        | Conforms to USB Specification 2.0  |
| DTE speed                     | 38,400 bps   |
| Connector specifications      | Computer: USB (Type A plug)<br>Digital Temperature Controller: Special serial connector        |
| Power supply                  | Bus power (Supplied from the USB host controller) *2   |
| Power supply voltage          | 5 VDC  |
| Current consumption           | 450 mA max.  |
| Output voltage                | 4.7±0.2 VDC (Supplied from USB-Serial Conversion Cable to the Digital Temperature Controller.) |
| Output current                | 250 mA max. (Supplied from USB-Serial Conversion Cable to the Digital Temperature Controller.) |
| Ambient operating temperature | 0 to 55°C (with no condensation or icing)  |
| Ambient operating humidity    | 10% to 80%   |
| Storage temperature           | -20 to 60°C (with no condensation or icing)  |
| Storage humidity              | 10% to 80%   |
| Altitude                      | 2,000 m max.   |
| Weight                        | Approx. 120 g  |

Windows is a registered trademark of Microsoft Corporation in the United States and or other countries.

\*1. CX-Thermo version 4.65 or higher runs on Windows 10.

\*2. Use a high-power port for the USB port.

**Note:** A driver must be installed on the computer. Refer to the *Instruction Manual* included with the Cable for the installation procedure.

## Communications Specifications

|                                     |  |
|-------------------------------------|--|
| Transmission line connection method | RS-485: Multidrop  |
| Communications                      | RS-485 (two-wire, half duplex)   |
| Synchronization method              | Start-stop synchronization   |
| Protocol                            | CompoWay/F, or Modbus  |
| Baud rate *                         | 9,600, 19,200, 38,400, or 57,600 bps   |
| Transmission code                   | ASCII  |
| Data bit length *                   | 7 or 8 bits  |
| Stop bit length *                   | 1 or 2 bits  |
| Error detection                     | Vertical parity (none, even, odd)<br>Block check character (BCC) with CompoWay/F or CRC-16 with Modbus |
| Flow control                        | None   |
| Interface                           | RS-485   |
| Retry function                      | None   |
| Communications buffer               | 217 bytes  |
| Communications response wait time   | 0 to 99 ms<br>Default: 20 ms   |

\* The baud rate, data bit length, stop bit length, and vertical parity can be individually set using the Communications Setting Level.

## Communications Functions

|                            |   |
|----------------------------|---|
| Programless communications | You can use the memory in the PLC to read and write E5□C parameters, start and stop operation, etc. The E5□C automatically performs communications with PLCs. No communications programming is required. Number of connected Digital Temperature Controllers: 32 max. (Up to 16 for the FX Series)<br>Applicable PLCs: OMRON PLCs<br>CS Series, CJ Series, or CP Series<br>Mitsubishi Electric PLCs<br>MELSEC Q Series, L Series, or FX Series (compatible with the FX2 or FX3 (excluding the FX1S))<br>KEYENCE PLCs<br>KEYENCE KV Series |
|----------------------------|---|

|                          |   |
|--------------------------|---|
| Component Communications | When Digital Temperature Controllers are connected, set points and RUN/STOP commands can be sent from the Digital Temperature Controller that is set as the master to the Digital Temperature Controllers that are set as slaves.<br>Slope and offsets can be set for the set point.<br>Number of connected Digital Temperature Controllers: 32 max. (including master) |
| Copying *                | When Digital Temperature Controllers are connected, the parameters can be copied from the Digital Temperature Controller that is set as the master to the Digital Temperature Controllers that are set as slaves.   |

MELSEC is a registered trademark of Mitsubishi Electric Corporation. KEYENCE is a registered trademark of Keyence Corporation.

\* Both the programless communications and the component communications support the copying.

## Current Transformer (Order Separately) Ratings

|                            |   |
|----------------------------|---|
| Dielectric strength        | 1,000 VAC for 1 min                               |
| Vibration resistance       | 50 Hz, 98 m/s <sup>2</sup>                        |
| Weight                     | E54-CT1: Approx. 11.5 g,<br>E54-CT3: Approx. 50 g |
| Accessories (E54-CT3 only) | Armatures (2)<br>Plugs (2)                        |

## Heater Burnout Alarms and SSR Failure Alarms

|   |  |
|---|--|
| CT input (for heater current detection) | Models with detection for single-phase heaters: One input                  |
| Maximum heater current                  | 50 A AC  |
| Input current indication accuracy       | ±5% FS ±1 digit max.   |
| Heater burnout alarm setting range *1   | 0.1 to 49.9 A (in units of 0.1 A)<br>Minimum detection ON time: 100 ms *3  |
| SSR failure alarm setting range *2      | 0.1 to 49.9 A (in units of 0.1 A)<br>Minimum detection OFF time: 100 ms *4 |

\*1. For heater burnout alarms, the heater current will be measured when the control output is ON, and the output will turn ON if the heater current is lower than the set value (i.e., heater burnout detection current value).

\*2. For SSR failure alarms, the heater current will be measured when the control output is OFF, and the output will turn ON if the heater current is higher than the set value (i.e., SSR failure detection current value).

\*3. The value is 30 ms for a control period of 0.1 s or 0.2 s.

\*4. The value is 35 ms for a control period of 0.1 s or 0.2 s.

## Electrical Life Expectancy Curve for Control Output Relay (Reference Values)

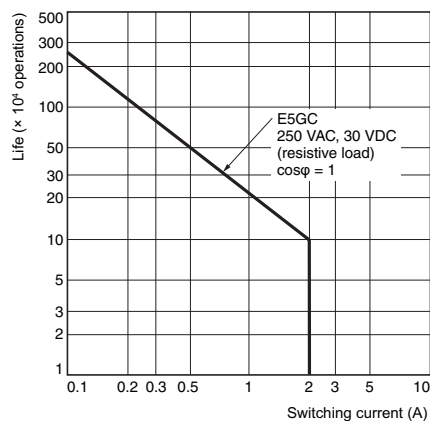

# External Connections

## E5GC

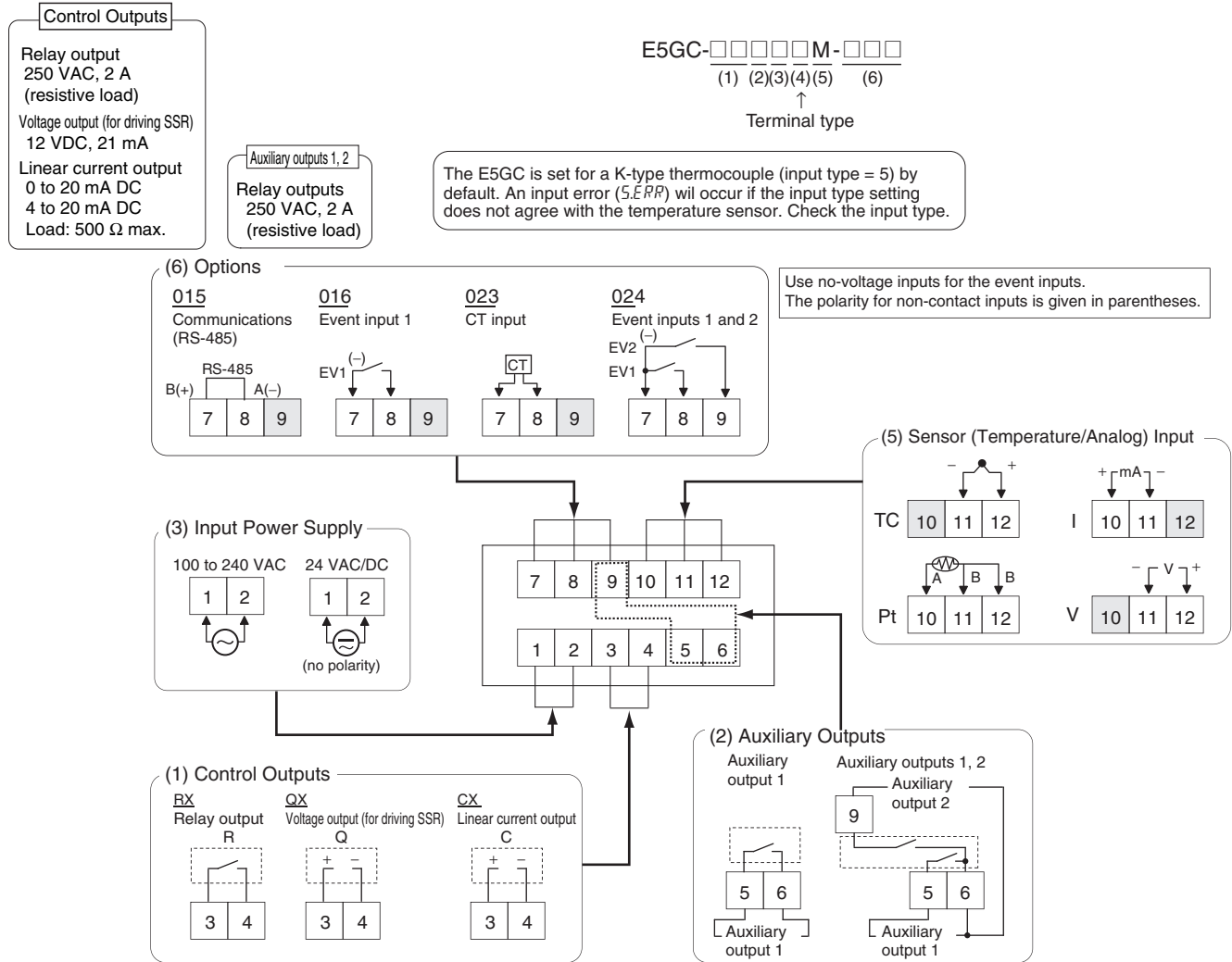

- Note:**
- The application of the terminals depends on the model.
  - Do not wire the terminals that are shown with a gray background.
  - When complying with EMC standards, the cable that connects the sensor must be 30 m or less. If the cable length exceeds 30 m, compliance with EMC standards will not be possible.
  - Connect M3 crimped terminals.

## Isolation/Insulation Block Diagrams

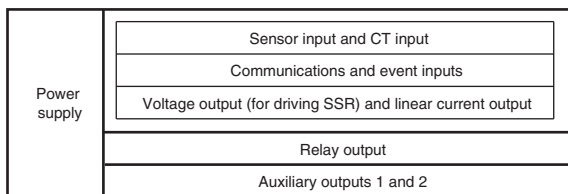

- : Reinforced insulation
- : Functional insulation

**Note:** Auxiliary outputs 1 to 2 are not insulated.

# E5GC

## Terminal Block Appearance

**E5GC-□6**  
Controllers with Screw Terminal Blocks (M3 Screws)

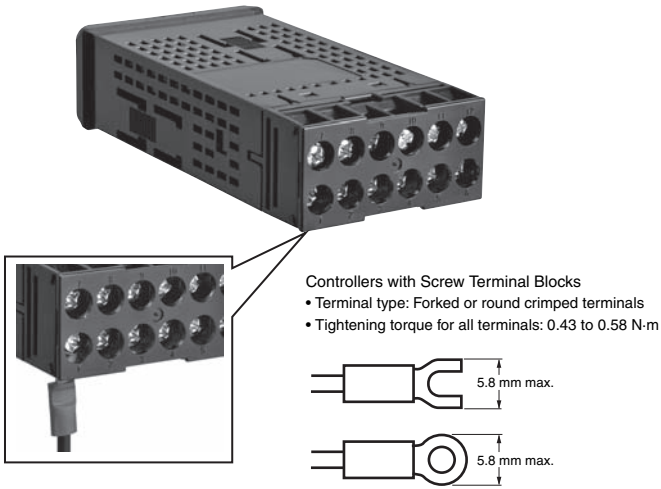

**E5GC-□C**  
Controllers with Screwless Clamp Terminal Blocks

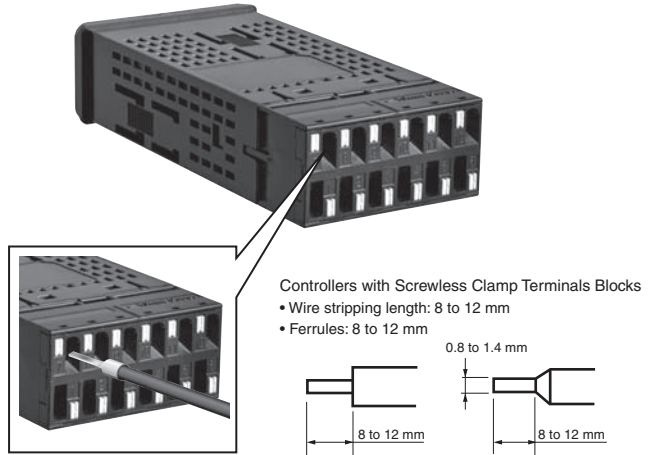

Wires: AWG24 to AWG18 (equal to a cross-sectional area of 0.21 to 0.82 mm<sup>2</sup>) braided or solid wires

**Note:** Refer to *Precautions When Wiring E5GC (Controllers with Screwless Clamp Terminal Blocks)* on page 115 for information on wiring Controllers with screwless clamp terminal blocks.

## Nomenclature

### E5GC

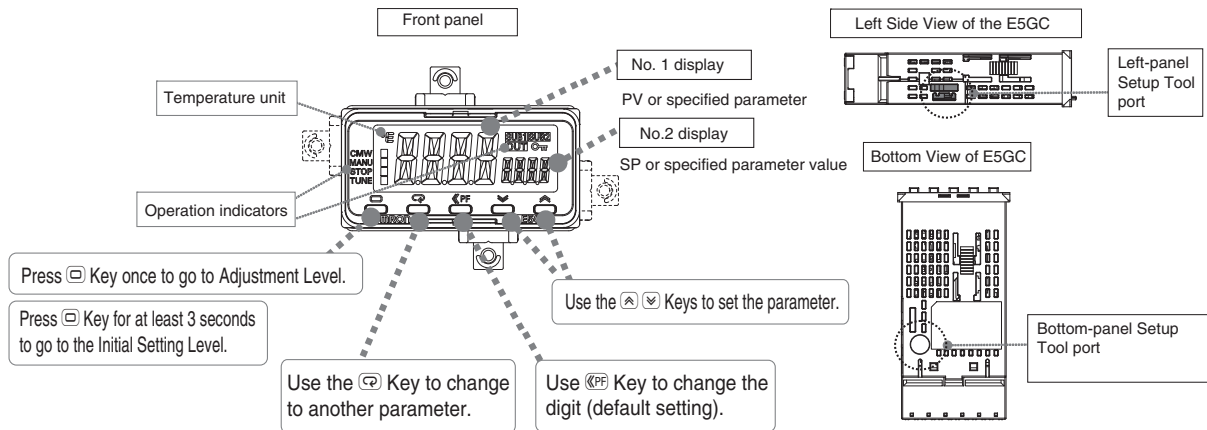

# Dimensions

## Controllers

### E5GC-□6 Controllers with Screw Terminal Blocks

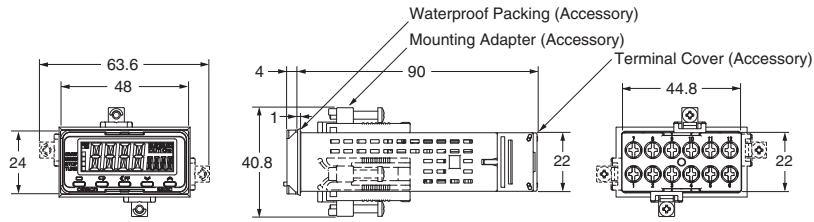

- Use two Mounting Adapters, either on the top and bottom or on the right and left.
- Setup Tool ports are provided as standard feature. Use these ports to connect a computer to the Digital Temperature Controller. The E58-CIFQ2 USB-Serial Conversion Cable is required to connect to the port on the side panel. The E58-CIFQ2 USB-Serial Conversion Cable and E58-CIFQ2-E Communications Conversion Cable are required to connect to the port on the bottom panel. (You cannot leave either port connected constantly during operation.)

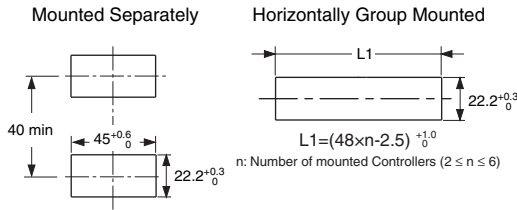

To mount the Temperature Controller so that it is waterproof, insert the Waterproof Packing onto the Temperature Controller. Group mounting does not allow waterproofing.

- To install the Temperature Controller, insert it into a square hole in a panel with a thickness of 1 to 8 mm, and then insert the enclosed adapter so that it locks into the grooves on the top and bottom or on the left and right of the rear case.
- Tighten the two mounting screws on the top and bottom or on the right and left of the Mounting Adapters alternately little by little to maintain a balance, and tighten them to a torque of between 0.29 and 0.39 N·m.
- When two or more Temperature Controllers are mounted, make sure that the surrounding temperature does not exceed the allowable operating temperature range given below.  
Horizontal group mounting: -10 to 55°C
- Use Temperature Controllers with Screwless Clamp Terminal Blocks for vertical group mounting.

### E5GC-□C Controllers with Screwless Clamp Terminal Blocks

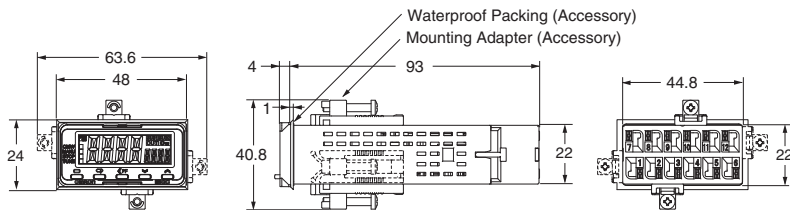

- Use two Mounting Adapters, either on the top and bottom or on the right and left.
- Setup Tool ports are provided as standard feature. Use these ports to connect a computer to the Digital Temperature Controller. The E58-CIFQ2 USB-Serial Conversion Cable is required to connect to the port on the side panel. The E58-CIFQ2 USB-Serial Conversion Cable and E58-CIFQ2-E Communications Conversion Cable are required to connect to the port on the bottom panel. (You cannot leave either port connected constantly during operation.)

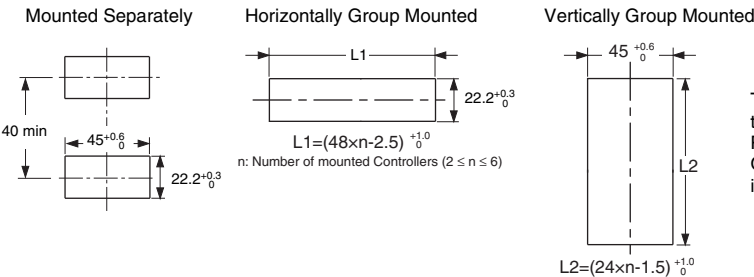

To mount the Temperature Controller so that it is waterproof, insert the Waterproof Packing onto the Temperature Controller. Group mounting does not allow waterproofing.

- To install the Temperature Controller, insert it into a square hole in a panel with a thickness of 1 to 8 mm, and then insert the enclosed adapter so that it locks into the grooves on the top and bottom or on the left and right of the rear case.
- Tighten the two mounting screws on the top and bottom or on the right and left of the Mounting Adapters alternately little by little to maintain a balance, and tighten them to a torque of between 0.29 and 0.39 N·m.
- When two or more Temperature Controllers are mounted, make sure that the surrounding temperature does not exceed the allowable operating temperature range given below.  
Horizontal group mounting: -10 to 55°C  
Vertical group mounting of two Controllers: -10 to 45°C  
Vertical group mounting of three or more Controllers: -10 to 40°C
- If you use vertical group mounting, you cannot draw out the interior body of the Controller.

# E5GC

## Accessories (Order Separately)

### USB-Serial Conversion Cable E58-CIFQ2

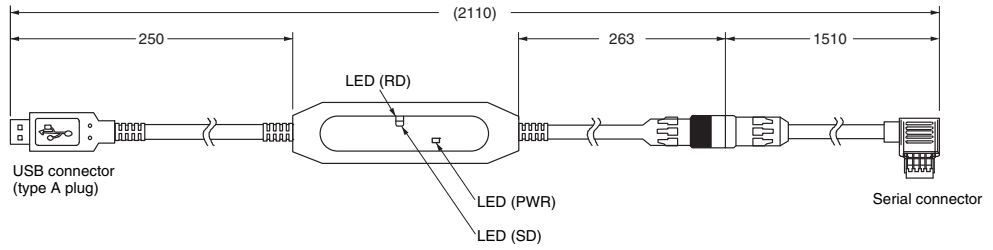

### Conversion Cable

#### E58-CIFQ2-E

Conversion Cable

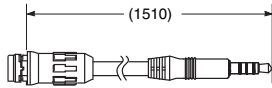

Connecting to the E58-CIFQ2 USB-Serial Conversion Cable

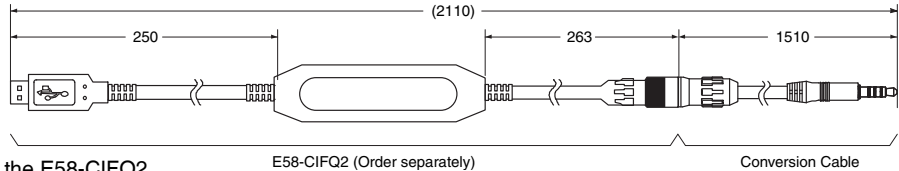

**Note:** Always use this product together with the E58-CIFQ2.

E58-CIFQ2 (Order separately)

Conversion Cable

## Current Transformers

### E54-CT1

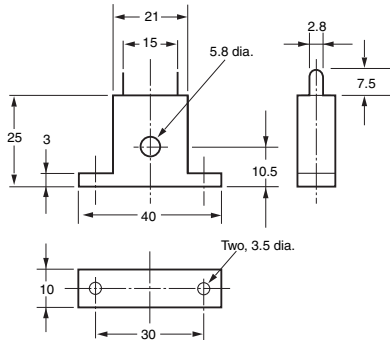
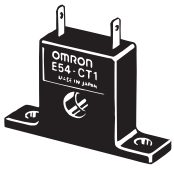

### Thru-current (Io) vs. Output Voltage (Eo) (Reference Values)

#### E54-CT1

Maximum continuous heater current: 50 A (50/60 Hz)

Number of windings: 400±2

Winding resistance: 18±2 Ω

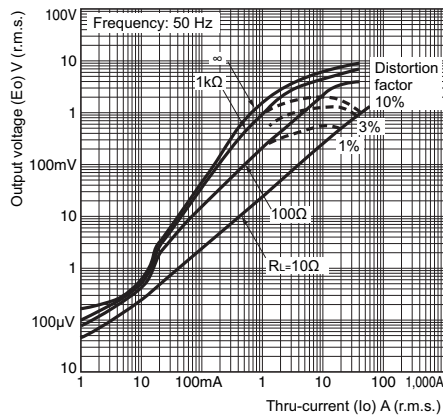

### E54-CT3

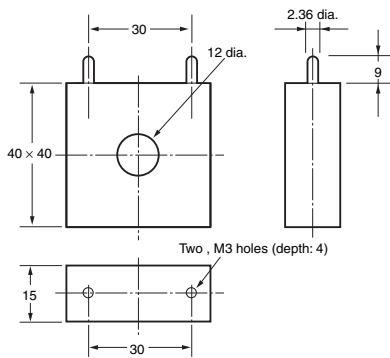

### Thru-current (Io) vs. Output Voltage (Eo) (Reference Values)

#### E54-CT3

Maximum continuous heater current: 120 A (50/60 Hz)

(Maximum continuous heater current for an OMRON Digital Temperature Controller is 50 A.)

Number of windings: 400±2

Winding resistance: 8±0.8 Ω

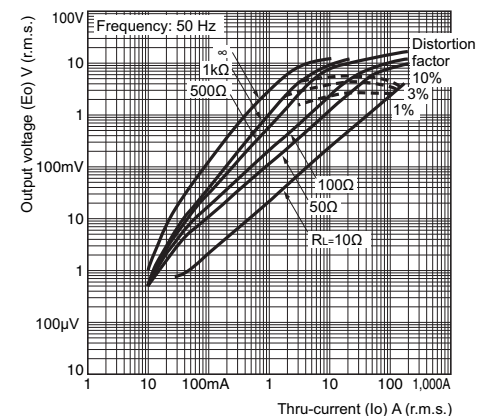

### E54-CT3 Accessories

#### • Armature

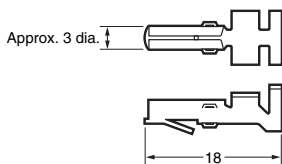

#### Connection Example

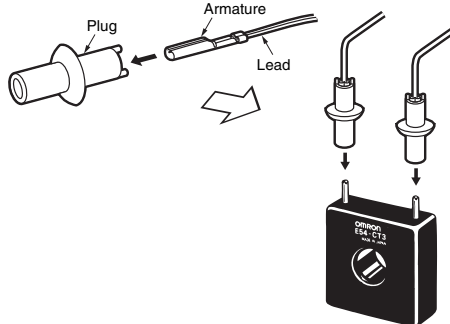

#### • Plug

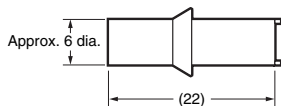

## Mounting Adapter Y92F-53 (Two provided.)

One pair is provided with the Temperature Controller. Order this Adapter separately if it becomes lost or damaged.

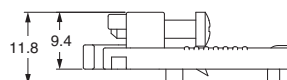
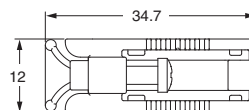
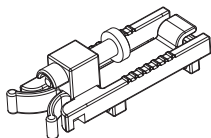

## Waterproof Packing Y92S-P12

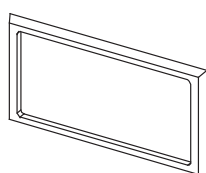

The Waterproof Packing is provided with the Temperature Controller. Order the Waterproof Packing separately if it becomes lost or damaged.

The Waterproof Packing can be used to achieve an IP66 degree of protection.

(Deterioration, shrinking, or hardening of the waterproof packing may occur depending on the operating environment. Therefore, periodic replacement is recommended to ensure the level of waterproofing specified in IP66. The time for periodic replacement depends on the operating environment. Be sure to confirm this point at your site. Consider three years a rough standard.)

## Draw-out Jig Y92F-55

Use this Draw-out Jig to remove the interior body of the Digital Temperature Controller from the case to perform maintenance without removing the terminal wiring.

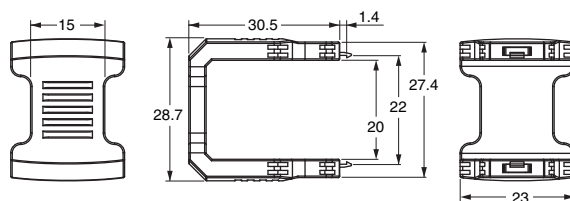
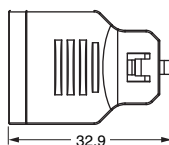
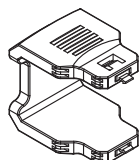

# Digital Temperature Controller

# E5CC/E5CC-B/E5CC-U (48 × 48 mm)

Large White PV Display That's Easier to Read.

Easy to Use, from Model Selection to Setup and Operation.

Models with Push-In Plus Terminal Blocks Added to Lineup.

- The white PV display with a height of 15.2 mm improves visibility.
- High-speed sampling at 50 ms.
- Select from models with screw terminal blocks, models with Push-In Plus terminal blocks for reduced wiring work, and Plug-in Models that can be removed from the terminal block.
- Short body with depth of only 60 mm. (Screw Terminal Blocks)
- Easy connections to a PLC with programless communications. Use component communications to link Temperature Controllers to each other.
- Set up the Controller without wiring the power supply by connecting to the computer with a Communications Conversion Cable (sold separately). Setup is easy with the CX-Thermo (sold separately).



(E5CC-U) (E5CC-B)

\* CSA conformance evaluation by UL.



48 × 48 mm  
Screw Terminal  
Blocks  
E5CC

48 × 48 mm  
Push-In Plus  
Terminal Blocks  
E5CC-B

48 × 48 mm  
Plug-in Models  
E5CC-U

Refer to your OMRON website for the most recent information on applicable safety standards.

Refer to Safety Precautions on 108.

## Main I/O Functions

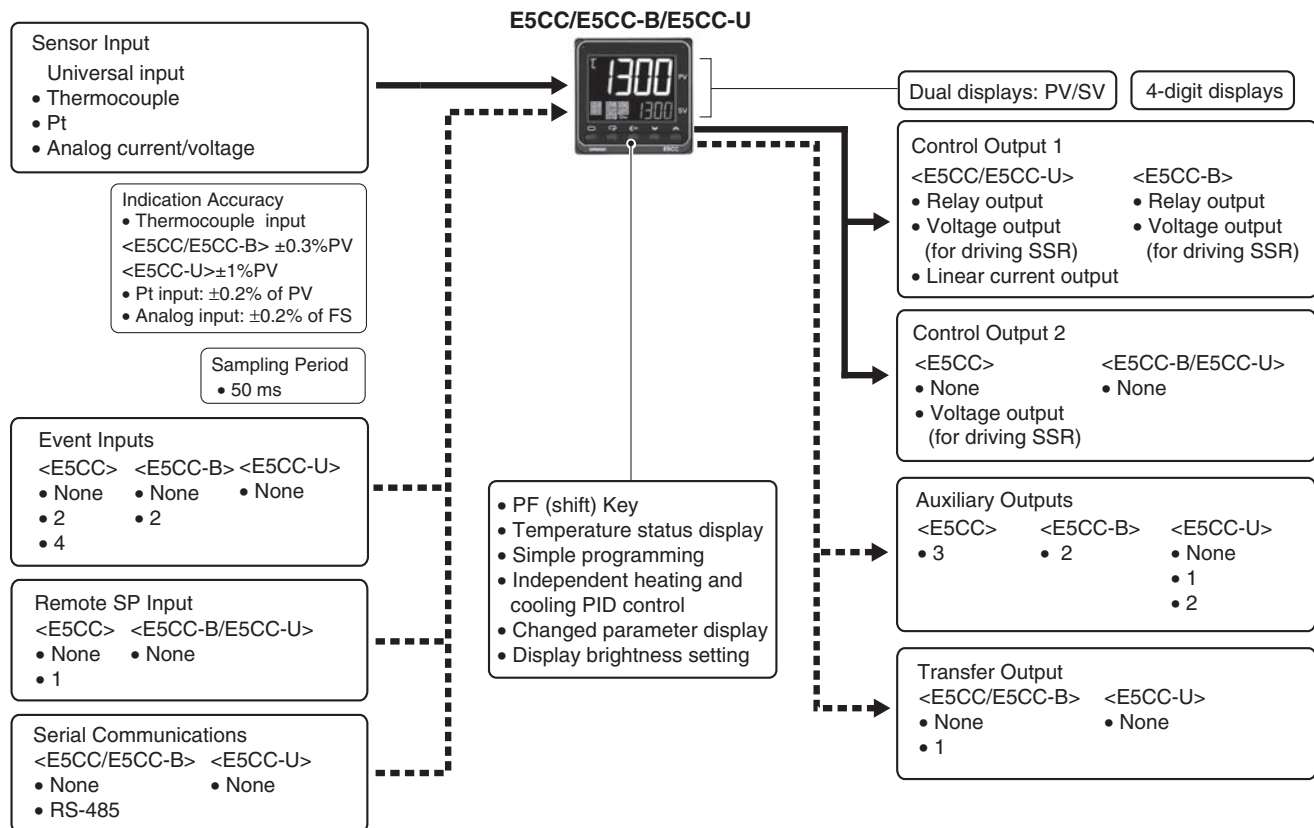

This datasheet is provided as a guideline for selecting products.

Be sure to refer to the following manuals for application precautions and other information required for operation before attempting to use the product.

E5□C Digital Temperature Controllers User's Manual (Cat. No. H174)

E5□C Digital Temperature Controllers Communications Manual (Cat. No. H175)



## Model Number Legend and Standard Models

### Model Number Legend

#### Models with Screw Terminal Blocks

E5CC-□□ 3 □ 5 M-□□□ (Example: E5CC-RX3A5M-000)

① ② ③ ④ ⑤ ⑥

| Model | ①                       | ②                        | ③                    | ④             | ⑤          | ⑥       | Meaning                            |                       |                            |                                  |                 |                 |
|-------|-------------------------|--------------------------|----------------------|---------------|------------|---------|------------------------------------|-----------------------|----------------------------|----------------------------------|-----------------|-----------------|
|       | Control outputs 1 and 2 | No. of auxiliary outputs | Power supply voltage | Terminal type | Input type | Options |                                    |                       |                            |                                  |                 |                 |
| E5CC  |                         |                          |                      |               |            |         | 48 × 48 mm                         |                       |                            |                                  |                 |                 |
|       |                         |                          |                      |               |            |         | Control output 1                   |                       |                            | Control output 2                 |                 |                 |
|       | RX                      |                          |                      |               |            |         | Relay output                       |                       |                            | None                             |                 |                 |
|       | QX                      |                          |                      |               |            |         | Voltage output (for driving SSR)   |                       |                            | None                             |                 |                 |
| *1 *3 | CX                      |                          |                      |               |            |         | Linear current output *2           |                       |                            | None                             |                 |                 |
|       | QQ                      |                          |                      |               |            |         | Voltage output (for driving SSR)   |                       |                            | Voltage output (for driving SSR) |                 |                 |
|       | CQ                      |                          |                      |               |            |         | Linear current output *2           |                       |                            | Voltage output (for driving SSR) |                 |                 |
|       |                         | 3                        |                      |               |            |         | 3 (one common)                     |                       |                            |                                  |                 |                 |
|       |                         |                          | A                    |               |            |         | 100 to 240 VAC                     |                       |                            |                                  |                 |                 |
|       |                         |                          | D                    |               |            |         | 24 VAC/DC                          |                       |                            |                                  |                 |                 |
|       |                         |                          |                      | 5             |            |         | Screw terminal blocks (with cover) |                       |                            |                                  |                 |                 |
|       |                         |                          |                      |               | M          |         | Universal input                    |                       |                            |                                  |                 |                 |
|       |                         |                          |                      |               |            |         |                                    | HB alarm and HS alarm | Communications             | Event inputs                     | Remote SP Input | Transfer output |
|       |                         |                          |                      |               |            |         |                                    | 000                   | ---                        | ---                              | ---             | ---             |
|       |                         |                          |                      |               |            | *1      |                                    | 001                   | 1                          | ---                              | 2               | ---             |
|       |                         |                          |                      |               |            | *1      |                                    | 003                   | 2<br>(for 3-phase heaters) | RS-485                           | ---             | ---             |
|       |                         |                          |                      |               |            | *3      |                                    | 004                   | ---                        | RS-485                           | 2               | ---             |
|       |                         |                          |                      |               |            |         |                                    | 005                   | ---                        | ---                              | 4               | ---             |
|       |                         |                          |                      |               |            |         |                                    | 006                   | ---                        | ---                              | 2               | Provided.       |
|       |                         |                          |                      |               |            |         |                                    | 007                   | ---                        | ---                              | 2               | Provided.       |

\*1. Options with HB and HS alarms (001 and 003) cannot be selected if a linear current output is selected for the control output.

\*2. The control output cannot be used as a transfer output.

\*3. Option 004 can be selected only when "CX" is selected for the control outputs.

**Note:** Draw-out-type models of the E5CC are available. Ask your OMRON representative for details.

## Heating and Cooling Control

### Using Heating and Cooling Control

#### ① Control Output Assignment

If there is no control output 2, an auxiliary output is used as the cooling control output.

If there is a control output 2, the two control outputs are used for heating and cooling.

(It does not matter which output is used for heating and which output is used for cooling.)

#### ② Control

If PID control is used, you can set PID control separately for heating and cooling.

This allows you to handle control systems with different heating and cooling response characteristics.

## Model Number Legend

Models with Push-In Plus Terminal Blocks

E5CC-□□ 2 □ B M -□□□ (Example: E5CC-RX2ABM-000)

① ② ③ ④ ⑤ ⑥

| Model | ①                       | ②                        | ③                    | ④             | ⑤          | ⑥       | Meaning                          |                |              |                  |                 |           |  |  |  |  |
|-------|-------------------------|--------------------------|----------------------|---------------|------------|---------|----------------------------------|----------------|--------------|------------------|-----------------|-----------|--|--|--|--|
|       | Control outputs 1 and 2 | No. of auxiliary outputs | Power supply voltage | Terminal type | Input type | Options |                                  |                |              |                  |                 |           |  |  |  |  |
| E5CC  |                         |                          |                      |               |            |         | 48 × 48 mm                       |                |              |                  |                 |           |  |  |  |  |
|       |                         |                          |                      |               |            |         | Control output 1                 |                |              | Control output 2 |                 |           |  |  |  |  |
|       | RX                      |                          |                      |               |            |         | Relay output                     |                |              | None             |                 |           |  |  |  |  |
|       | QX                      |                          |                      |               |            |         | Voltage output (for driving SSR) |                |              | None             |                 |           |  |  |  |  |
|       |                         | 2                        |                      |               |            |         | 2 (one common)                   |                |              |                  |                 |           |  |  |  |  |
|       |                         |                          | A                    |               |            |         | 100 to 240 VAC                   |                |              |                  |                 |           |  |  |  |  |
|       |                         |                          | D                    |               |            |         | 24 VAC/DC                        |                |              |                  |                 |           |  |  |  |  |
|       |                         |                          |                      | B             |            |         | Push-in plus terminal blocks     |                |              |                  |                 |           |  |  |  |  |
|       |                         |                          |                      |               | M          |         | Universal input                  |                |              |                  |                 |           |  |  |  |  |
|       |                         |                          |                      |               |            |         | HB alarm and HS alarm            | Communications | Event inputs | Remote SP Input  | Transfer output |           |  |  |  |  |
|       |                         |                          |                      |               |            |         | 000                              | ---            | ---          | ---              | ---             | ---       |  |  |  |  |
|       |                         |                          |                      |               |            |         | 001                              | 1              | ---          | 2                | ---             | ---       |  |  |  |  |
|       |                         |                          |                      |               |            |         | 002                              | 1              | RS-485       | ---              | ---             | ---       |  |  |  |  |
|       |                         |                          |                      |               |            |         | 004                              | ---            | RS-485       | 2                | ---             | ---       |  |  |  |  |
|       |                         |                          |                      |               |            |         | 006                              | ---            | ---          | 2                | ---             | Provided. |  |  |  |  |

## Heating and Cooling Control

### Using Heating and Cooling Control

#### ① Control Output Assignment

An auxiliary output is used as the cooling control output.

#### ② Control

If PID control is used, you can set PID control separately for heating and cooling.

This allows you to handle control systems with different heating and cooling response characteristics.

## Model Number Legend

### Plug-in Models

E5CC-□□ □□ U M -000

(Example: E5CC-RW0AUM-000)

① ② ③ ④ ⑤ ⑥

| Model | ①                       | ②                        | ③                    | ④             | ⑤          | ⑥       | Meaning                          |                |              |                  |                 |  |  |
|-------|-------------------------|--------------------------|----------------------|---------------|------------|---------|----------------------------------|----------------|--------------|------------------|-----------------|--|--|
|       | Control outputs 1 and 2 | No. of auxiliary outputs | Power supply voltage | Terminal type | Input type | Options |                                  |                |              |                  |                 |  |  |
| E5CC  |                         |                          |                      |               |            |         | 48 × 48 mm                       |                |              |                  |                 |  |  |
|       |                         |                          |                      |               |            |         | Control output 1                 |                |              | Control output 2 |                 |  |  |
|       | RW                      |                          |                      |               |            |         | Relay output (SPDT)              |                |              | None             |                 |  |  |
|       | QX                      |                          |                      |               |            |         | Voltage output (for driving SSR) |                |              | None             |                 |  |  |
|       | CX                      |                          |                      |               |            |         | Linear current output *          |                |              | None             |                 |  |  |
|       |                         | 0                        |                      |               |            |         | None                             |                |              |                  |                 |  |  |
|       |                         | 1                        |                      |               |            |         | 1                                |                |              |                  |                 |  |  |
|       |                         | 2                        |                      |               |            |         | 2 (one common)                   |                |              |                  |                 |  |  |
|       |                         |                          | A                    |               |            |         | 100 to 240 VAC                   |                |              |                  |                 |  |  |
|       |                         |                          | D                    |               |            |         | 24 VAC/DC                        |                |              |                  |                 |  |  |
|       |                         |                          |                      | U             |            |         | Plug-in model                    |                |              |                  |                 |  |  |
|       |                         |                          |                      |               | M          |         | Universal input                  |                |              |                  |                 |  |  |
|       |                         |                          |                      |               |            |         | HB alarm and HS alarm            | Communications | Event inputs | Remote SP Input  | Transfer output |  |  |
|       |                         |                          |                      |               |            | 000     | ---                              | ---            | ---          | ---              | ---             |  |  |

\* The control output can be used as a simple transfer output for the Digital Temperature Controllers manufactured in May 2014 or later.

## List of Models

| Control output                   | No. of auxiliary outputs | Options               |                     |                | Model                |                 |
|----------------------------------|--------------------------|-----------------------|---------------------|----------------|----------------------|-----------------|
|                                  |                          | HB alarm and HS alarm | No. of event inputs | Communications | Power supply voltage |                 |
|                                  |                          |                       |                     |                | 100 to 240 VAC       | 24 VAC/DC       |
| Relay output                     | ---                      | ---                   | ---                 | ---            | E5CC-RW0AUM-000      | E5CC-RW0DUM-000 |
|                                  | 1                        |                       |                     |                | E5CC-RW1AUM-000      | E5CC-RW1DUM-000 |
|                                  | 2                        |                       |                     |                | E5CC-RW2AUM-000      | E5CC-RW2DUM-000 |
| Voltage output (for driving SSR) | ---                      | ---                   | ---                 | ---            | E5CC-QX0AUM-000      | E5CC-QX0DUM-000 |
|                                  | 1                        |                       |                     |                | E5CC-QX1AUM-000      | E5CC-QX1DUM-000 |
|                                  | 2                        |                       |                     |                | E5CC-QX2AUM-000      | E5CC-QX2DUM-000 |
| Linear current output            | ---                      | ---                   | ---                 | ---            | E5CC-CX0AUM-000      | E5CC-CX0DUM-000 |
|                                  | 1                        |                       |                     |                | E5CC-CX1AUM-000      | E5CC-CX1DUM-000 |
|                                  | 2                        |                       |                     |                | E5CC-CX2AUM-000      | E5CC-CX2DUM-000 |

## Heating and Cooling Control

### Using Heating and Cooling Control

#### ① Control Output Assignment

An auxiliary output is used as the cooling control output.

#### ② Control

If PID control is used, you can set PID control separately for heating and cooling.

This allows you to handle control systems with different heating and cooling response characteristics.

# E5CC/E5CC-B/E5CC-U

## Optional Products (Order Separately)

### USB-Serial Conversion Cable

| Model     |
|-----------|
| E58-CIFQ2 |

### Terminal Covers (for E5CC)

| Model            |
|------------------|
| E53-COV17        |
| E53-COV23 (3pcs) |

**Note:** The E53-COV10 cannot be used.  
Refer to page 31 for the mounted dimensions.

### Waterproof Packing

| Model   |
|---------|
| Y92S-P8 |

**Note:** The Waterproof Packing is provided only with E5CC/E5CC-B Controllers.  
The E5CC-U cannot be waterproofed even if the Waterproof Packing is attached.

### Current Transformers (CTs)

| Hole diameter | Model   |
|---------------|---------|
| 5.8 mm        | E54-CT1 |
| 12.0 mm       | E54-CT3 |

### Adapter

| Model   |
|---------|
| Y92F-45 |

**Note:** Use this Adapter when the panel has already been prepared for an E5B□ Controller.

### Waterproof Cover

| Model    |
|----------|
| Y92A-48N |

### Mounting Adapter

| Model   |
|---------|
| Y92F-49 |

**Note:** This Mounting Adapter is provided with the Digital Temperature Controller.

### DIN Track Mounting Adapter (for E5CC)

| Model   |
|---------|
| Y92F-52 |

### Sockets (for E5CC-U)

| Type   | Model     |
|--|-----------|
| Front-connecting Socket  | P2CF-11   |
| Front-connecting Socket with Finger Protection                   | P2CF-11-E |
| Back-connecting Socket   | P3GA-11   |
| Terminal Cover for Back-connecting socket with Finger Protection | Y92A-48G  |

### Front Covers

| Type             | Model    |
|------------------|----------|
| Hard Front Cover | Y92A-48H |
| Soft Front Cover | Y92A-48D |

### CX-Thermo Support Software

| Model       |
|-------------|
| EST2-2C-MV4 |

**Note:** CX-Thermo version 4.5 or higher is required for the E5CC.  
CX-Thermo version 4.61 or higher is required for the E5CC-U.  
CX-Thermo version 4.65 or higher is required for the E5CC-B.  
For the system requirements for the CX-Thermo, refer to information on the EST2-2C-MV4 on the OMRON website ([www.ia.omron.com](http://www.ia.omron.com)).

## Specifications

### Ratings

|                                      |  |   |
|--------------------------------------|--|---|
| <b>Power supply voltage</b>          |  | A in model number: 100 to 240 VAC, 50/60 Hz<br>D in model number: 24 VAC, 50/60 Hz; 24 VDC  |
| <b>Operating voltage range</b>       |  | 85% to 110% of rated supply voltage   |
| <b>Power consumption</b>             |  | Models with option selection of 000:5.2 VA max. at 100 to 240 VAC, and 3.1 VA max. at 24 VAC or 1.6 W max. at 24 VDC<br>All other models: 6.5 VA max. at 100 to 240 VAC, and 4.1 VA max. at 24 VAC or 2.3 W max. at 24 VDC  |
| <b>Sensor input</b>                  |  | Temperature input<br>Thermocouple: K, J, T, E, L, U, N, R, S, B, W, or PL II<br>Platinum resistance thermometer: Pt100 or JPt100<br>Infrared temperature sensor (ES1B): 10 to 70°C, 60 to 120°C, 115 to 165°C, or 140 to 260°C<br>Analog input<br>Current input: 4 to 20 mA or 0 to 20 mA<br>Voltage input: 1 to 5 V, 0 to 5 V, 0 to 10 V, or 0 to 50 mV (The 0 to 50 mV range applies to the E5CC-U only for those manufactured in May 2014 or later.)                   |
| <b>Input impedance</b>               |  | Current input: 150 Ω max., Voltage input: 1 MΩ min.<br>(Use a 1:1 connection when connecting the ES2-HB/THB.)   |
| <b>Control method</b>                |  | ON/OFF control or 2-PID control (with auto-tuning)  |
| <b>Control output</b>                | <b>Relay output</b>                          | E5CC/E5CC-B: SPST-NO, 250 VAC, 3 A (resistive load), electrical life: 100,000 operations, minimum applicable load: 5 V, 10 mA (reference value)<br>E5CC-U: SPDT, 250 VAC, 3 A (resistive load), electrical life: 100,000 operations, minimum applicable load: 5 V, 10 mA (reference value)  |
|                                      | <b>Voltage output (for driving SSR)</b>      | Output voltage: 12 VDC ±20% (PNP), max. load current: 21 mA, with short-circuit protection circuit  |
|                                      | <b>Linear current output *2</b>              | 4 to 20 mA DC/0 to 20 mA DC, load: 500 Ω max., resolution: approx. 10,000   |
| <b>Auxiliary output</b>              | <b>Number of outputs</b>                     | E5CC: 3<br>E5CC-B: 2<br>E5CC-U: 1 or 2 (depends on model)   |
|                                      | <b>Output specifications</b>                 | SPST-NO relay outputs, 250 VAC, Models with 1 output: 3 A (resistive load), E5CC-U models with 2 outputs: 3 A (resistive load), E5CC-B models with 2 outputs: 2 A (resistive load), Models with 3 outputs: 2 A (resistive load), Electrical life: 100,000 operations, Minimum applicable load: 10 mA at 5 V (reference value)   |
| <b>Event input *1</b>                | <b>Number of inputs</b>                      | E5CC: 2 or 4 (depends on model)<br>E5CC-B: 2 (depends on model)   |
|                                      | <b>External contact input specifications</b> | Contact input: ON: 1 kΩ max., OFF: 100 kΩ min.<br>Non-contact input: ON: Residual voltage: 1.5 V max., OFF: Leakage current: 0.1 mA max.<br>Current flow: Approx. 7 mA per contact  |
| <b>Transfer output *1</b>            | <b>Number of outputs</b>                     | 1 (only on models with a transfer output)   |
|                                      | <b>Output specifications</b>                 | Current output: 4 to 20 mA DC, load: 500 Ω max., resolution: approx. 10,000<br>Linear voltage output: 1 to 5 VDC, load: 1 kΩ min., resolution: Approx. 10,000   |
| <b>Setting method</b>                |  | Digital setting using front panel keys  |
| <b>Remote SP input *1 *2</b>         |  | Current input: 4 to 20 mA DC or 0 to 20 mA DC (input impedance: 150 Ω max.)<br>Voltage input: 1 to 5 V, 0 to 5 V, or 0 to 10 V (input impedance: 1 MΩ min.)   |
| <b>Indication method</b>             |  | 11-segment digital display and individual indicators<br>Character height: PV: 15.2 mm, SV: 7.1 mm   |
| <b>Multi SP *3</b>                   |  | Up to eight set points (SP0 to SP7) can be saved and selected using the event inputs, key operations, or serial communications.   |
| <b>Bank switching</b>                |  | None  |
| <b>Other functions</b>               |  | Manual output, heating/cooling control, loop burnout alarm, SP ramp, other alarm functions, heater burnout (HB) alarm (including SSR failure (HS) alarm), 40% AT, 100% AT, MV limiter, input digital filter, self tuning, robust tuning, PV input shift, run/stop, protection functions, extraction of square root, MV change rate limit, logic operations, temperature status display, simple programming, moving average of input value, and display brightness setting |
| <b>Ambient operating temperature</b> |  | -10 to 55°C (with no condensation or icing), For 3-year warranty: -10 to 50°C with standard mounting (with no condensation or icing)  |
| <b>Ambient operating humidity</b>    |  | 25% to 85%  |
| <b>Storage temperature</b>           |  | -25 to 65°C (with no condensation or icing)   |
| <b>Altitude</b>                      |  | 2,000 m max.  |
| <b>Recommended fuse</b>              |  | T2A, 250 VAC, time-lag, low-breaking capacity   |
| <b>Installation environment</b>      |  | Overvoltage category II, Pollution Degree 2 (EN/IEC/UL 61010-1)   |

\*1. There are no optional functions for the E5CC-U. Refer to *Model Number Legend* and *List of Models* on page 19.

\*2. This function is not supported by the E5CC-B. Refer to *Model Number Legend* on page 18.

\*3. With the E5CC-B, there can be up to four set points if event inputs are used to select them.

## Input Ranges

### Thermocouple/Platinum Resistance Thermometer (Universal inputs)

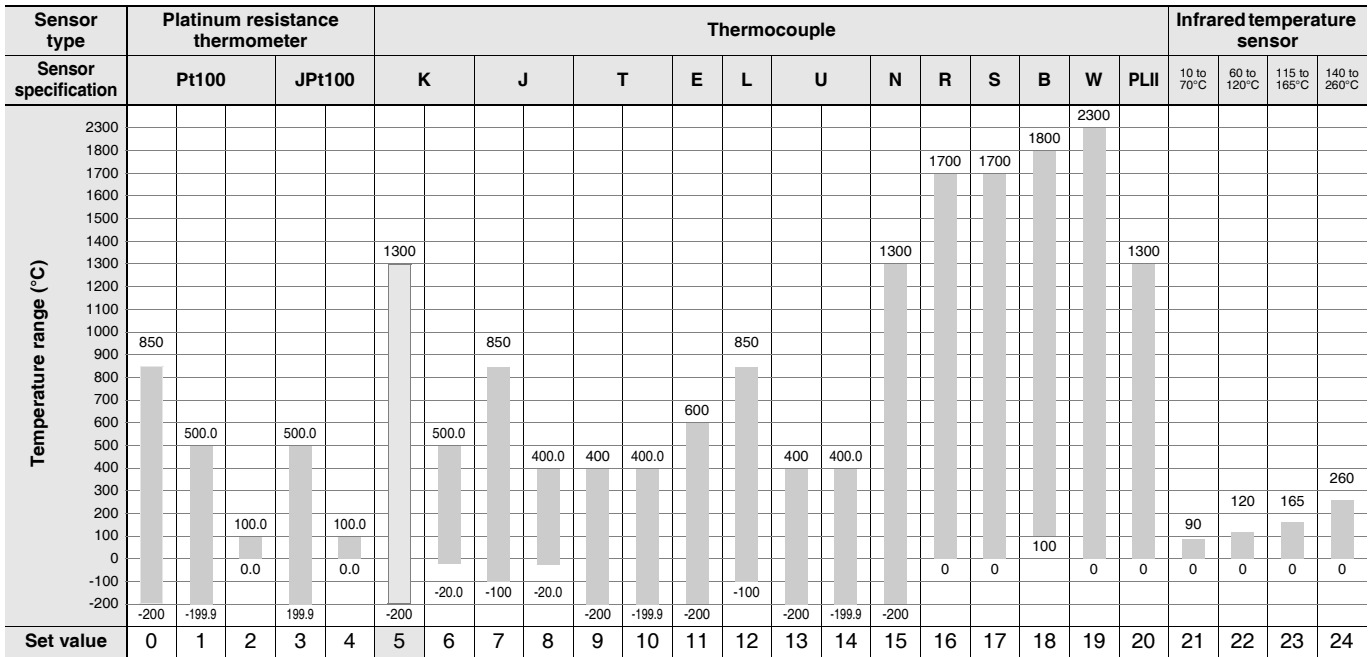

Shaded settings are the default settings.

The applicable standards for the input types are as follows:

K, J, T, E, N, R, S, B: JIS C 1602-1995, IEC 60584-1

JPt100: JIS C 1604-1989, JIS C 1606-1989

L: Fe-CuNi, DIN 43710-1985

Pt100: JIS C 1604-1997, IEC 60751

U: Cu-CuNi, DIN 43710-1985

PL II: According to Platinel II electromotive force charts from BASF (previously Engelhard)

W: W5Re/W26Re, ASTM E988-1990

## Analog input

| Input type          | Current   |            | Voltage  |          |           |             |
|---------------------|---|------------|----------|----------|-----------|-------------|
| Input specification | 4 to 20 mA  | 0 to 20 mA | 1 to 5 V | 0 to 5 V | 0 to 10 V | 0 to 50 mV* |
| Setting range       | Usable in the following ranges by scaling:<br>-1999 to 9999, -199.9 to 999.9,<br>-19.99 to 99.99 or -1.999 to 9.999 |            |          |          |           |             |
| Set value           | 25  | 26         | 27       | 28       | 29        | 30          |

\* The range applies to the E5CC-U only for those manufactured in May 2014 or later.









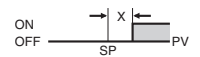

## Alarm Types

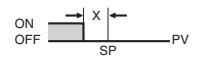
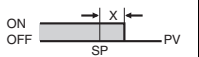
Each alarm can be independently set to one of the following 19 alarm types. The default is 2: Upper limit. (see note.)

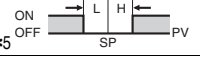
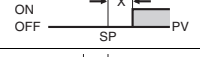
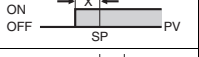
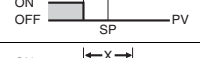
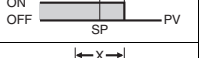
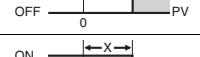
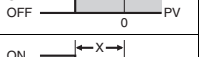
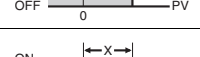
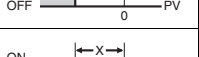
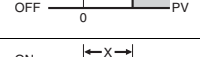
Auxiliary outputs are allocated for alarms. ON delays and OFF delays (0 to 999 s) can also be specified.

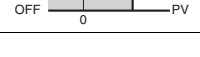
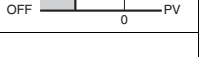
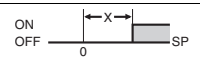
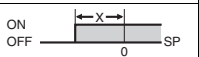
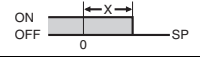
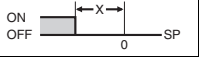
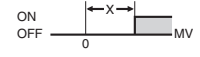
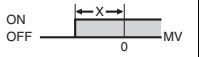
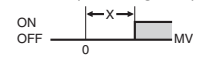
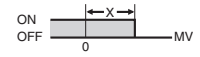
**Note:** In the default settings for models with HB or HS alarms, alarm 1 is set to a heater alarm (HA) and the Alarm Type 1 parameter is not displayed.

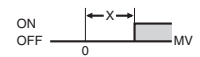
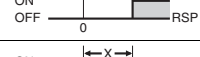
To use alarm 1, set the output assignment to alarm 1.

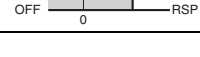
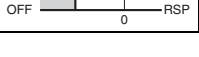
| Set value   | Alarm type                                       | Alarm output operation  |   | Description of function  |
|-------------|--|---|---|--|
|             |  | When alarm value X is positive  | When alarm value X is negative  |  |
| 0           | Alarm function OFF                               | Output OFF  |   | No alarm   |
| 1           | Upper- and lower-limit *1                        |    | *2  | Set the upward deviation in the set point for the alarm upper limit (H) and the lower deviation in the set point for the alarm lower limit (L). The alarm is ON when the PV is outside this deviation range. |
| 2 (default) | Upper-limit                                      |    |                        | Set the upward deviation in the set point by setting the alarm value (X). The alarm is ON when the PV is higher than the SP by the deviation or more.  |
| 3           | Lower-limit                                      |    |                        | Set the downward deviation in the set point by setting the alarm value (X). The alarm is ON when the PV is lower than the SP by the deviation or more.   |
| 4           | Upper- and lower-limit range *1                  |    | *3  | Set the upward deviation in the set point for the alarm upper limit (H) and the lower deviation in the set point for the alarm lower limit (L). The alarm is ON when the PV is inside this deviation range.  |
| 5           | Upper- and lower-limit with standby sequence *1  | *5   | *4  | A standby sequence is added to the upper- and lower-limit alarm (1). *6  |
| 6           | Upper-limit with standby sequence                |    |                        | A standby sequence is added to the upper-limit alarm (2). *6   |
| 7           | Lower-limit with standby sequence                |   |                       | A standby sequence is added to the lower-limit alarm (3). *6   |
| 8           | Absolute-value upper-limit                       |    |                      | The alarm will turn ON if the process value is larger than the alarm value (X) regardless of the set point.  |
| 9           | Absolute-value lower-limit                       |    |                      | The alarm will turn ON if the process value is smaller than the alarm value (X) regardless of the set point.   |
| 10          | Absolute-value upper-limit with standby sequence |    |                      | A standby sequence is added to the absolute-value upper-limit alarm (8). *6  |
| 11          | Absolute-value lower-limit with standby sequence |    |                      | A standby sequence is added to the absolute-value lower-limit alarm (9). *6  |
| 12          | LBA (alarm 1 type only)                          | -   |   | *7   |
| 13          | PV change rate alarm                             | -   |   | *8   |
| 14          | SP absolute-value upper-limit alarm              |    |                      | This alarm type turns ON the alarm when the set point (SP) is higher than the alarm value (X).   |
| 15          | SP absolute-value lower-limit alarm              |    |                      | This alarm type turns ON the alarm when the set point (SP) is lower than the alarm value (X).  |
| 16          | MV absolute-value upper-limit alarm *9           | Standard Control<br>                     | Standard Control<br> | This alarm type turns ON the alarm when the manipulated variable (MV) is higher than the alarm value (X).  |
|             |  | Heating/Cooling Control (Heating MV)<br> | Heating/Cooling Control (Heating MV)<br>Always ON   |  |
| 17          | MV absolute-value lower-limit alarm *9           | Standard Control<br>                     | Standard Control<br> | This alarm type turns ON the alarm when the manipulated variable (MV) is lower than the alarm value (X).   |
|             |  | Heating/Cooling Control (Cooling MV)<br> | Heating/Cooling Control (Cooling MV)<br>Always ON   |  |
| 18          | RSP absolute-value upper-limit alarm *10         |    |                      | This alarm type turns ON the alarm when the remote SP (RSP) is higher than the alarm value (X).  |
| 19          | RSP absolute-value lower-limit alarm *10         |    |                      | This alarm type turns ON the alarm when the remote SP (RSP) is lower than the alarm value (X).   |

**\*1.** With set values 1, 4 and 5, the upper and lower limit values can be set independently for each alarm type, and are expressed as "L" and "H."

**\*2.** Set value: 1, Upper- and lower-limit alarm

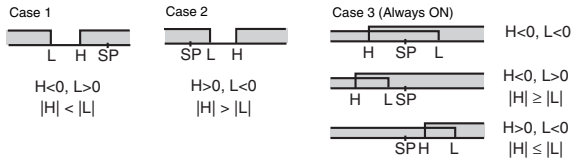

**\*3.** Set value: 4, Upper- and lower-limit range

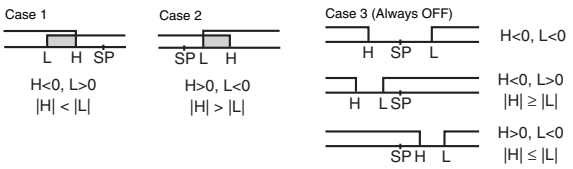

**\*4.** Set value: 5, Upper- and lower-limit with standby sequence  
 For Upper- and Lower-Limit Alarm Described Above \*2

- Case 1 and 2  
Always OFF when the upper-limit and lower-limit hysteresis overlaps.
- Case 3: Always OFF

**\*5.** Set value: 5, Upper- and lower-limit with standby sequence  
Always OFF when the upper-limit and lower-limit hysteresis overlaps.

**\*6.** Refer to the *E5CC Digital Temperature Controllers User's Manual* (Cat. No. H174) for information on the operation of the standby sequence.

**\*7.** Refer to the *E5CC Digital Temperature Controllers User's Manual* (Cat. No. H174) for information on the loop burnout alarm (LBA).

**\*8.** Refer to the *E5CC Digital Temperature Controllers User's Manual* (Cat. No. H174) for information on the PV change rate alarm.

**\*9.** When heating/cooling control is performed, the MV absolute upper limit alarm functions only for the heating operation and the MV absolute lower limit alarm functions only for the cooling operation.

**\*10.** This value is displayed only when a remote SP input is used. It functions in both Local SP Mode and Remote SP Mode. Remote SP input is supported only for the E5CC.



## Characteristics

|   |   |  |
|---|---|--|
| <b>Indication accuracy<br/>(at the ambient temperature of 23°C)</b> | E5CC/E5CC-B<br>Thermocouple: (±0.3% of indication value or ±1°C, whichever is greater) ±1 digit max. *1<br>Platinum resistance thermometer: (±0.2% of indication value or ±0.8°C, whichever is greater) ±1 digit max.<br>Analog input: ±0.2% FS ±1 digit max.<br>CT input: ±5% FS ±1 digit max.<br>E5CC-U<br>Thermocouple: (±1% of indication value or ±2°C, whichever is greater) ±1 digit max. *1<br>Platinum resistance thermometer: (±0.2% of indication value or ±0.8°C, whichever is greater) ±1 digit max.<br>Analog input: ±0.2% FS ±1 digit max. |  |
| <b>Transfer output accuracy</b>                                     | ±0.3% FS max.   |  |
| <b>Simple transfer output accuracy</b>                              | ±0.3% FS max.*2   |  |
| <b>Remote SP Input Type</b>   | ±0.2% FS ±1 digit max.  |  |
| <b>Influence of temperature *3</b>                                  | Thermocouple input (R, S, B, W, PL II): (±1% of indication value or ±10°C, whichever is greater) ±1 digit max.<br>Other thermocouple input: (±1% of indication value or ±4°C, whichever is greater) ±1 digit max. *4  |  |
| <b>Influence of voltage *3</b>                                      | Platinum resistance thermometer: (±1% of indication value or ±2°C, whichever is greater) ±1 digit max.<br>Analog input: ±1% FS ±1 digit max.  |  |
| <b>Influence of EMS.<br/>(at EN 61326-1)</b>                        | CT input: ±5% FS ±1 digit max.<br>Remote SP input: ±1% FS ±1 digit max.   |  |
| <b>Input sampling period</b>  | 50 ms   |  |
| <b>Hysteresis</b>   | Temperature input: 0.1 to 999.9°C or °F (in units of 0.1°C or °F)<br>Analog input: 0.01% to 99.99% FS (in units of 0.01% FS)  |  |
| <b>Proportional band (P)</b>  | Temperature input: 0.1 to 999.9°C or °F (in units of 0.1°C or °F)<br>Analog input: 0.1% to 999.9% FS (in units of 0.1% FS)  |  |
| <b>Integral time (I)</b>  | 0 to 9999 s (in units of 1 s), 0.0 to 999.9 s (in units of 0.1 s) *5  |  |
| <b>Derivative time (D)</b>  | 0 to 9999 s (in units of 1 s), 0.0 to 999.9 s (in units of 0.1 s) *5  |  |
| <b>Proportional band (P) for cooling</b>                            | Temperature input: 0.1 to 999.9°C or °F (in units of 0.1°C or °F)<br>Analog input: 0.1% to 999.9% FS (in units of 0.1% FS)  |  |
| <b>Integral time (I) for cooling</b>                                | 0 to 9999 s (in units of 1 s), 0.0 to 999.9 s (in units of 0.1 s) *5  |  |
| <b>Derivative time (D) for cooling</b>                              | 0 to 9999 s (in units of 1 s), 0.0 to 999.9 s (in units of 0.1 s) *5  |  |
| <b>Control period</b>   | 0.1, 0.2, 0.5, 1 to 99 s (in units of 1 s)  |  |
| <b>Manual reset value</b>   | 0.0 to 100.0% (in units of 0.1%)  |  |
| <b>Alarm setting range</b>  | -1999 to 9999 (decimal point position depends on input type)  |  |
| <b>Influence of signal source resistance</b>                        | Thermocouple: 0.1°C/Ω max. (100 Ω max.)<br>Platinum resistance thermometer: 0.1°C/Ω max. (10 Ω max.)  |  |
| <b>Insulation resistance</b>  | 20 MΩ min. (at 500 VDC)   |  |
| <b>Dielectric strength</b>  | 3,000 VAC, 50/60 Hz for 1 min between terminals of different charge   |  |
| <b>Vibration</b>  | <b>Malfunction</b>  | 10 to 55 Hz, 20 m/s <sup>2</sup> for 10 min each in X, Y, and Z directions |
|   | <b>Resistance</b>   | 10 to 55 Hz, 20 m/s <sup>2</sup> for 2 hrs each in X, Y, and Z directions  |
| <b>Shock</b>  | <b>Malfunction</b>  | 100 m/s <sup>2</sup> , 3 times each in X, Y, and Z directions              |
|   | <b>Resistance</b>   | 300 m/s <sup>2</sup> , 3 times each in X, Y, and Z directions              |
| <b>Weight</b>   | E5CC/E5CC-B: Controller: Approx. 120 g, Adapter: Approx. 10 g<br>E5CC-U: Controller: Approx. 100 g, Adapter: Approx. 10 g   |  |
| <b>Degree of protection</b>   | E5CC/E5CC-B: Front panel: IP66, Rear case: IP20, Terminals: IP00<br>E5CC-U: Front panel: IP50, Rear case: IP20, Terminals: IP00   |  |
| <b>Memory protection</b>  | Non-volatile memory (number of writes: 1,000,000 times)   |  |
| <b>Setup Tool</b>   | E5CC: CX-Thermo version 4.5 or higher<br>E5CC-B: CX-Thermo version 4.65 or higher<br>E5CC-U: CX-Thermo version 4.61 or higher   |  |
| <b>Setup Tool port</b>  | E5CC/E5CC-B/E5CC-U top panel: An E58-CIFQ2 USB-Serial Conversion Cable is used to connect to a USB port on the computer. *6   |  |

\*1. The indication accuracy of K thermocouples in the -200 to 1,300°C range, T and N thermocouples at a temperature of -100°C max., and U and L thermocouples at any temperatures is ±2°C ±1 digit max. The indication accuracy of the B thermocouple at a temperature of 400°C max. is not specified. The indication accuracy of B thermocouples at a temperature of 400 to 800°C is ±3°C max. The indication accuracy of the R and S thermocouples at a temperature of 200°C max. is ±3°C ±1 digit max. The indication accuracy of W thermocouples is (±0.3% of PV or ±3°C, whichever is greater) ±1 digit max. The indication accuracy of PL II thermocouples is (±0.3% of PV or ±2°C, whichever is greater) ±1 digit max.

\*2. However, the precision between 0 and 4 mA for a 0 to 20 mA output is ±1% FS max.

\*3. Ambient temperature: -10°C to 23°C to 55°C, Voltage range: -15% to 10% of rated voltage

\*4. K thermocouple at -100°C max.: ±10°C max.

\*5. The unit is determined by the setting of the Integral/Derivative Time Unit parameter.

\*6. External communications (RS-485) and USB-serial conversion cable communications can be used at the same time.

## E5CC/E5CC-B/E5CC-U

| Standards | Approved standards                                    | cULus: UL 61010-1/CSA C22.2 No.61010-1 *7, KOSHA (S Mark) certification (Some models only.) *8, Korean wireless regulations (Radio law: KC Mark) (Some models only.) *8, Lloyd's standards *9 |
|-----------|---|---|
|           | Conformed standards                                   | EN 61010-1 (IEC 61010-1)  |
| EMC       | EMI:  | EN 61326-1 *10  |
|           | Radiated Interference Electromagnetic Field Strength: | EN 55011 Group 1, class A   |
|           | Noise Terminal Voltage:                               | EN 55011 Group 1, class A   |
|           | EMS:  | EN 61326-1 *10  |
|           | ESD Immunity:   | EN 61000-4-2  |
|           | Electromagnetic Field Immunity:                       | EN 61000-4-3  |
|           | Burst Noise Immunity:                                 | EN 61000-4-4  |
|           | Conducted Disturbance Immunity:                       | EN 61000-4-6  |
|           | Surge Immunity:                                       | EN 61000-4-5  |
|           | Voltage Dip/Interrupting Immunity:                    | EN 61000-4-11   |

\*7. The E5CC-U plug-in model is certified for UL listing only when used together with the OMRON P2CF-11 or P2CF-11-E Socket. The P3GA-11 is not certified for UL listing.

\*8. Access the following website for information on certified models. <http://www.ia.omron.com/support/models/index.html>

\*9. Refer to information on maritime standards in *Shipping Standards* on page 106 for compliance with Lloyd's Standards.

\*10. Industrial electromagnetic environment (EN/IEC 61326-1 Table 2)

## USB-Serial Conversion Cable

|                                      |  |
|--------------------------------------|--|
| <b>Applicable OS</b>                 | Windows XP/Vista/7/8/10 *1   |
| <b>Applicable software</b>           | CX-Thermo version 4.5 or higher<br>(Version 4.61 or higher is required for the E5CC-U, Version 4.65 or higher is required for the E5CC-B.) |
| <b>Applicable models</b>             | E5□C-T Series, E5□C Series, and E5CB Series  |
| <b>USB interface standard</b>        | Conforms to USB Specification 2.0.   |
| <b>DTE speed</b>                     | 38400 bps  |
| <b>Connector specifications</b>      | Computer: USB (type A plug)<br>Digital Temperature Controller: Special serial connector  |
| <b>Power supply</b>                  | Bus power (Supplied from USB host controller.)*2   |
| <b>Power supply voltage</b>          | 5 VDC  |
| <b>Current consumption</b>           | 450 mA max.  |
| <b>Output voltage</b>                | 4.7±0.2 VDC<br>(Supplied from USB-Serial Conversion Cable to the Digital Temperature Controller.)  |
| <b>Output current</b>                | 250 mA max.<br>(Supplied from USB-Serial Conversion Cable to the Digital Temperature Controller.)  |
| <b>Ambient operating temperature</b> | 0 to 55°C (with no condensation or icing)  |
| <b>Ambient operating humidity</b>    | 10% to 80%   |
| <b>Storage temperature</b>           | -20 to 60°C (with no condensation or icing)  |
| <b>Storage humidity</b>              | 10% to 80%   |
| <b>Altitude</b>                      | 2,000 m max.   |
| <b>Weight</b>                        | Approx. 120 g  |

Windows is a registered trademark of Microsoft Corporation in the United States and or other countries.

\*1. CX-Thermo version 4.65 or higher runs on Windows 10.

\*2. Use a high-power port for the USB port.

**Note:** A driver must be installed on the computer. Refer to the *Instruction Manual* included with the Cable for the installation procedure.

## Communications Specifications

|  |   |
|--|---|
| <b>Transmission line connection method</b> | RS-485: Multidrop   |
| <b>Communications</b>                      | RS-485 (two-wire, half duplex)  |
| <b>Synchronization method</b>              | Start-stop synchronization  |
| <b>Protocol</b>                            | CompoWay/F, or Modbus   |
| <b>Baud rate *</b>                         | 9600, 19200, 38400, or 57600 bps  |
| <b>Transmission code</b>                   | ASCII   |
| <b>Data bit length *</b>                   | 7 or 8 bits   |
| <b>Stop bit length *</b>                   | 1 or 2 bits   |
| <b>Error detection</b>                     | Vertical parity (none, even, odd)<br>Block check character (BCC) with CompoWay/F or CRC-16 Modbus |
| <b>Flow control</b>                        | None  |
| <b>Interface</b>                           | RS-485  |
| <b>Retry function</b>                      | None  |
| <b>Communications buffer</b>               | 217 bytes   |
| <b>Communications response wait time</b>   | 0 to 99 ms<br>Default: 20 ms  |

\* The baud rate, data bit length, stop bit length, and vertical parity can be individually set using the Communications Setting Level.

## Communications Functions

|                                      |   |
|--------------------------------------|---|
| <b>Programless communications *1</b> | You can use the memory in the PLC to read and write E5□C parameters, start and stop operation, etc. The E5□C automatically performs communications with PLCs. No communications programming is required. Number of connected Digital Temperature Controllers: 32 max. (Up to 16 for the FX Series)<br>Applicable PLCs<br>OMRON PLCs<br>CS Series, CJ Series, or CP Series<br>Mitsubishi Electric PLCs<br>MELSEC Q Series, L Series, or FX Series (compatible with the FX2 or FX3 (excluding the FX1S))<br>KEYENCE PLCs<br>KEYENCE KV Series |
|--------------------------------------|---|

|                                    |   |
|------------------------------------|---|
| <b>Component Communications *1</b> | When Digital Temperature Controllers are connected, set points and RUN/STOP commands can be sent from the Digital Temperature Controller that is set as the master to the Digital Temperature Controllers that are set as slaves. Slope and offsets can be set for the set point. Number of connected Digital Temperature Controllers: 32 max. (including master) |
| <b>Copying *2</b>                  | When Digital Temperature Controllers are connected, the parameters can be copied from the Digital Temperature Controller that is set as the master to the Digital Temperature Controllers that are set as slaves.   |

MELSEC is a registered trademark of Mitsubishi Electric Corporation. KEYENCE is a registered trademark of Keyence Corporation.

\*1. A Temperature Controller with version 1.1 or higher is required. A Temperature Controller with version 2.1 or higher is required for the FX Series or the KV Series.

\*2. Both the programless communications and the component communications support the copying.

## Current Transformer (Order Separately) Ratings

|                                   |   |
|-----------------------------------|---|
| <b>Dielectric strength</b>        | 1,000 VAC for 1 min                               |
| <b>Vibration resistance</b>       | 50 Hz, 98 m/s <sup>2</sup>                        |
| <b>Weight</b>                     | E54-CT1: Approx. 11.5 g,<br>E54-CT3: Approx. 50 g |
| <b>Accessories (E54-CT3 only)</b> | Armatures (2)<br>Plugs (2)                        |

## Heater Burnout Alarms and SSR Failure Alarms

|  |   |
|--|---|
| <b>CT input (for heater current detection)</b> | Models with detection for single-phase heaters: One input<br>Models with detection for singlephase or three-phase heaters: Two inputs |
| <b>Maximum heater current</b>                  | 50 A AC   |
| <b>Input current indication accuracy</b>       | ±5% FS ±1 digit max.  |
| <b>Heater burnout alarm setting range *1</b>   | 0.1 to 49.9 A (in units of 0.1 A)<br>Minimum detection ON time: 100 ms *3   |
| <b>SSR failure alarm setting range *2</b>      | 0.1 to 49.9 A (in units of 0.1 A)<br>Minimum detection OFF time: 100 ms *4  |

\*1. For heater burnout alarms, the heater current will be measured when the control output is ON, and the output will turn ON if the heater current is lower than the set value (i.e., heater burnout detection current value).

\*2. For SSR failure alarms, the heater current will be measured when the control output is OFF, and the output will turn ON if the heater current is higher than the set value (i.e., SSR failure detection current value).

\*3. The value is 30 ms for a control period of 0.1 s or 0.2 s.

\*4. The value is 35 ms for a control period of 0.1 s or 0.2 s.

## Electrical Life Expectancy Curve for Relays (Reference Values)

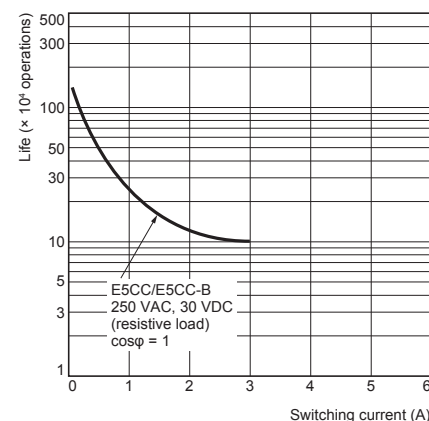

# E5CC/E5CC-B/E5CC-U

## External Connections

### E5CC (Screw Terminal Blocks)

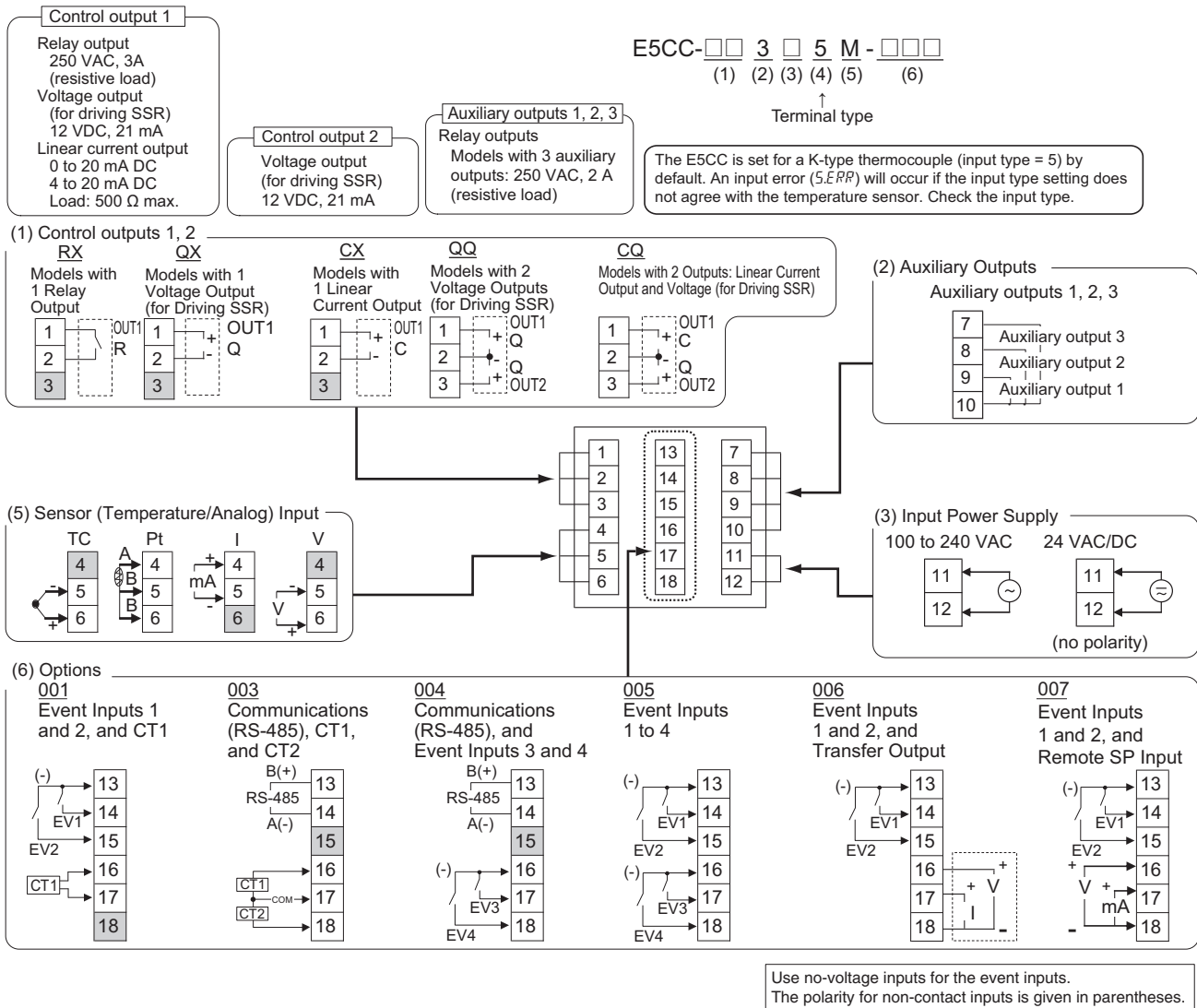

- Note:**
1. The application of the terminals depends on the model.
  2. Do not wire the terminals that are shown with a gray background.
  3. When complying with EMC standards, the cable that connects the sensor must be 30 m or less.  
If the cable length exceeds 30 m, compliance with EMC standards will not be possible.
  4. Connect M3 crimped terminals.

E5CC-B (Push-In Plus Terminal Blocks)

E5CC-□□ 2 □ B M - □□□  
 (1) (2) (3) (4) (5) (6)

Terminal type

Control output 1  
 Relay output  
 250 VAC, 3A  
 (resistive load)  
 Voltage output  
 (for driving SSR)  
 12 VDC, 21 mA

Auxiliary outputs 1, 2  
 Relay outputs  
 outputs: 250 VAC, 2 A  
 (resistive load)

The E5CC is set for a K-type thermocouple (input type = 5) by default. An input error (5ERR) will occur if the input type setting does not agree with the temperature sensor. Check the input type.

(1) Control outputs 1

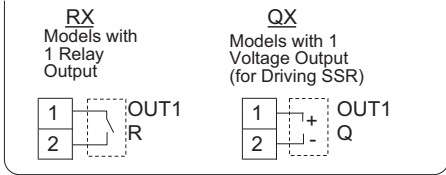

(5) Sensor (Temperature/Analog) Input

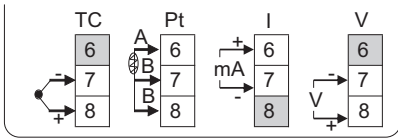

(6) Options

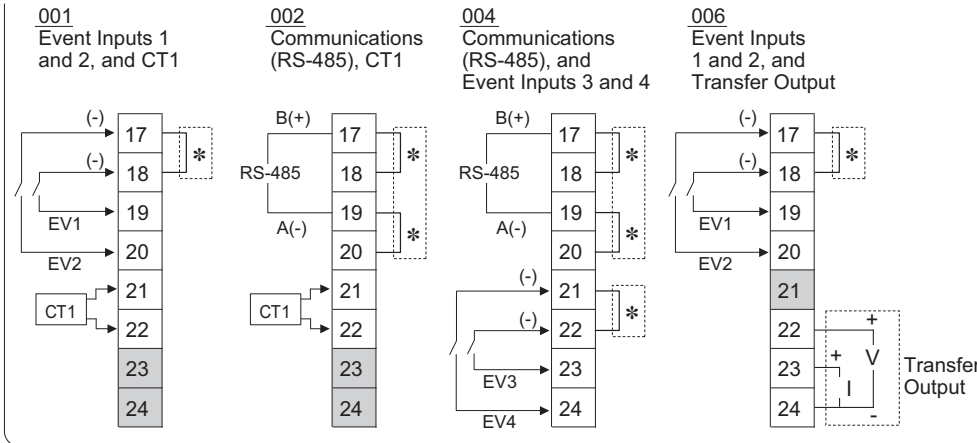

Use no-voltage inputs for the event inputs.  
 The polarity for non-contact inputs is given in parentheses.

(2) Auxiliary Outputs

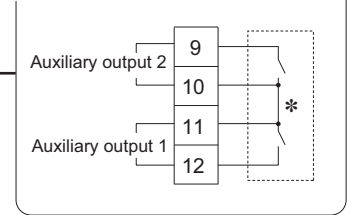

(3) Input Power Supply

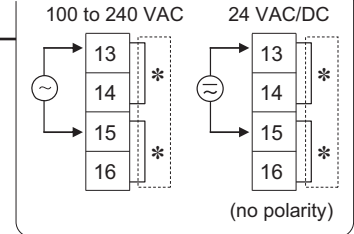

- Note:**
- The application of the terminals depends on the model.
  - Do not wire the terminals that are shown with a gray background.
  - When complying with EMC standards, the cable that connects the sensor must be 30 m or less. If the cable length exceeds 30 m, compliance with EMC standards will not be possible.
  - Refer to *Wiring Precautions for E5□C-B (Controllers with Push-In Plus Terminal Blocks)* on page 116 for wire specifications and wiring methods.
  - Common terminals are indicated with asterisks (\*). You can use the input power supply and communications common terminals for crossover wiring. Do not exceed the maximum number of Temperature Controllers given below if you use crossover wiring for the input power supply.  
 100 to 240 VAC Controllers: 16 max.  
 24 VAC/VDC Controllers: 8 max.

Wiring Example:

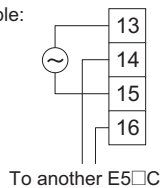

# E5CC/E5CC-B/E5CC-U

## E5CC-U (Plug-in Models)

The E5CC-U is set for a K-type thermocouple (input type = 5) by default. An input error (5.ERR) will occur if the input type setting does not agree with the temperature sensor. Check the input type.

E5CC-□□□□UM-000

Control output 1

Auxiliary outputs 1, 2  
Relay output  
250 VAC, 3 A (resistive load)

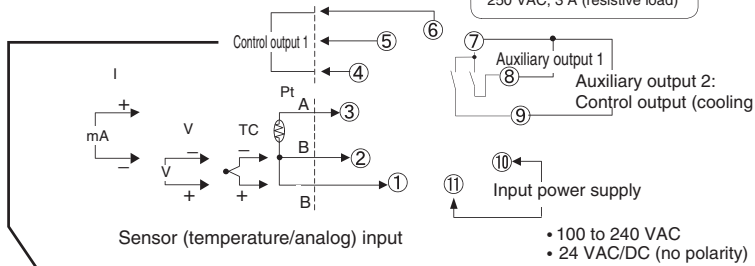

• 100 to 240 VAC  
• 24 VAC/DC (no polarity)

Control output 1

Voltage output (for driving SSR)  
12 VDC, 21 mA  
Linear current output  
4 to 20 mA DC  
0 to 20 mA DC  
Load: 500 Ω max.  
Relay output (three terminals used)  
SPDT, 250 VAC, 3 A  
(resistive load)

Control output 1:

**QX**  
Models with 1  
Voltage Output  
(for Driving SSR)

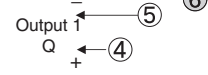

**CX**  
Models with 1  
Linear Current  
Output

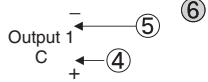

**RW**  
Models with 1  
Relay Output

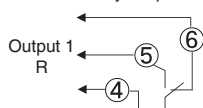

- Note:**
1. The application of the terminals depends on the model.
  2. Do not wire the terminals that are shown with a gray background.
  3. When complying with EMC standards, the cable that connects the sensor must be 30 m or less. If the cable length exceeds 30 m, compliance with EMC standards will not be possible.
  4. Connect M3.5 crimped terminals.

## Isolation/Insulation Block Diagrams

### E5CC

#### Models with 3 Auxiliary Outputs

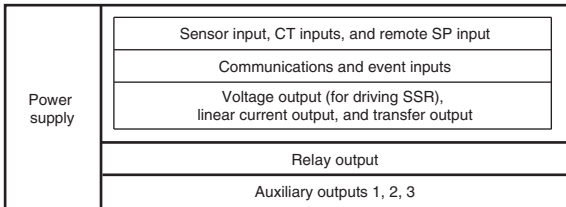

Reinforced insulation  
Functional isolation

**Note:** Auxiliary outputs 1 to 3 are not insulated.

### E5CC-U

#### Models with 2 Auxiliary Outputs

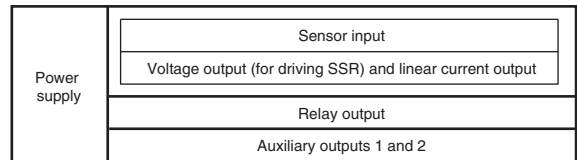

Reinforced insulation  
Functional isolation

### E5CC-B

#### Models with 2 Auxiliary Outputs

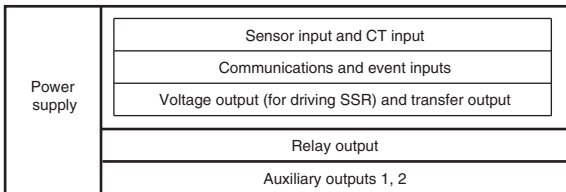

Reinforced insulation  
Functional isolation

## Nomenclature

E5CC  
E5CC-B  
E5CC-U

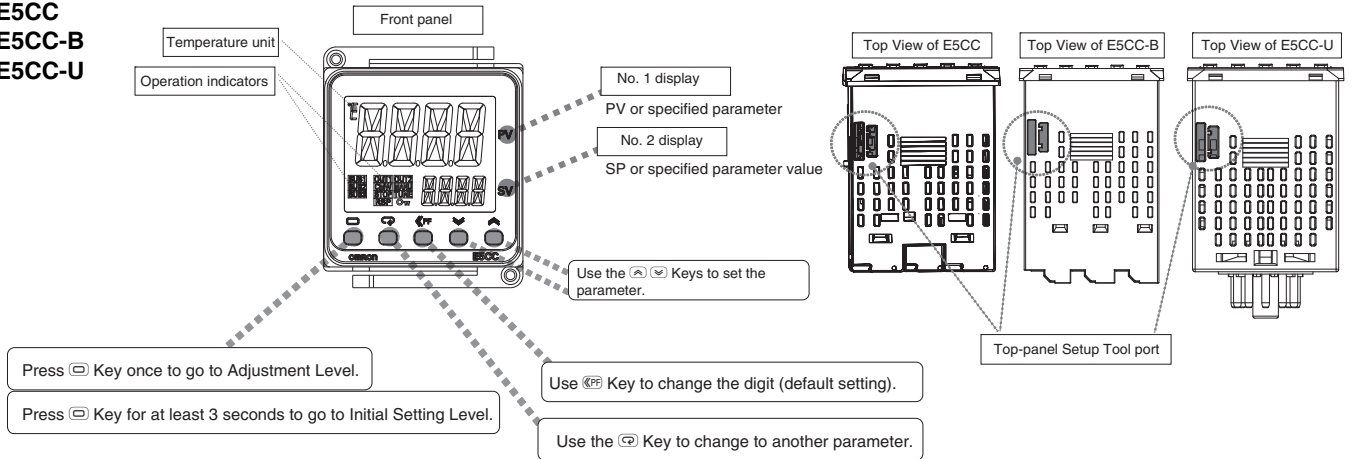

## Dimensions

(Unit: mm)

### Controllers

E5CC

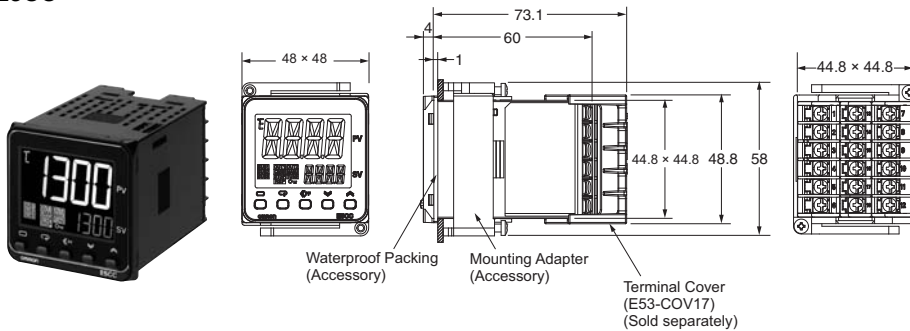

E5CC-B

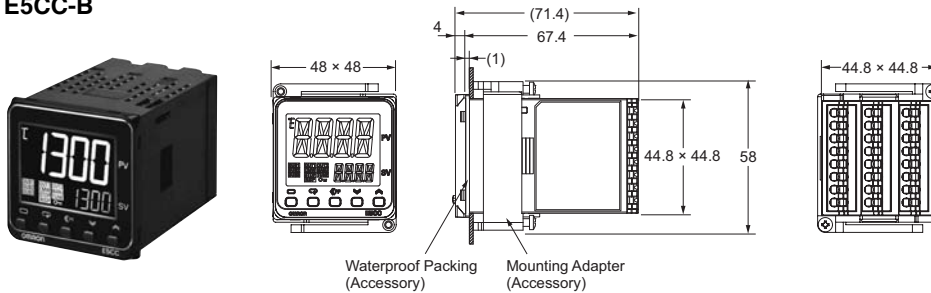

The Setup Tool port is on the top of the Temperature Controller.

It is used to connect the Temperature Controller to the computer to use the Setup Tool.

The E58-CIFQ2 USB-Serial Conversion Cable is required to make the connection.

Refer to the instructions that are provided with the USB-Serial Conversion Cable for the connection procedure.

**Note:** Do not leave the USB-Serial Conversion Cable connected when you use the Temperature Controller.

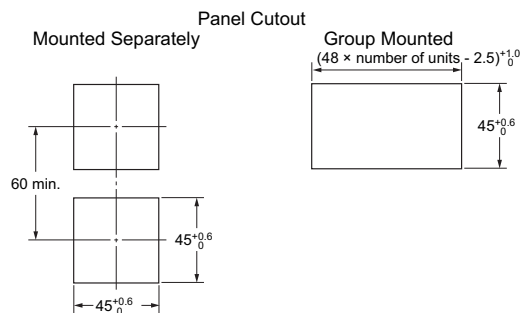

- Recommended panel thickness is 1 to 5 mm.
- Group mounting is not possible in the vertical direction. (Maintain the specified mounting space between Controllers.)
- To mount the Controller so that it is waterproof, insert the waterproof packing onto the Controller.
- When two or more Controllers are mounted, make sure that the surrounding temperature does not exceed the allowable operating temperature specified in the specifications.
- Use a control panel thickness of 1 to 3 mm if the Y92A-48N and a USB-Serial Conversion Cable are used together.

# E5CC/E5CC-B/E5CC-U

## E5CC-U

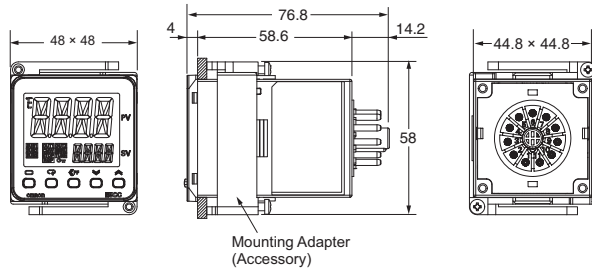

The Setup Tool port is on the top of the Temperature Controller. It is used to connect the Temperature Controller to the computer to use the Setup Tool. The E58-CIFQ2 USB-Serial Conversion Cable is required to make the connection.

Refer to the instructions that are provided with the USB-Serial Conversion Cable for the connection procedure.

**Note:** Do not leave the USB-Serial Conversion Cable connected when you use the Temperature Controller.

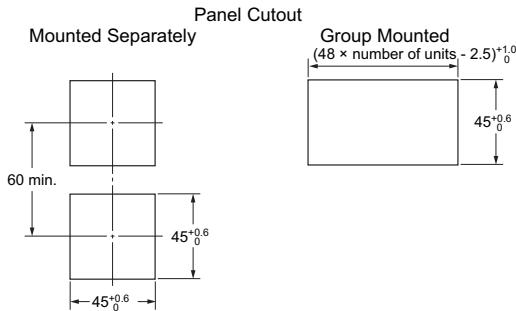

- Recommended panel thickness is 1 to 5 mm.
- Group mounting is not possible in the vertical direction. (Maintain the specified mounting space between Controllers.)
- When two or more Controllers are mounted, make sure that the surrounding temperature does not exceed the allowable operating temperature specified in the specifications.
- Use a control panel thickness of 1 to 3 mm if the Y92A-48N and a USB-Serial Conversion Cable are used together.

## Accessories (Order Separately)

### USB-Serial Conversion Cable

#### E58-CIFQ2

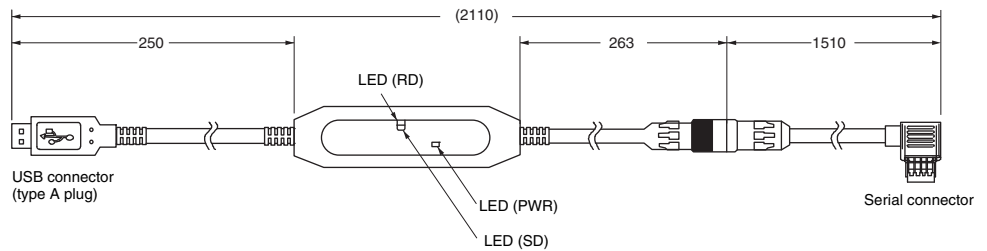

### Terminal Covers

#### E53-COV17

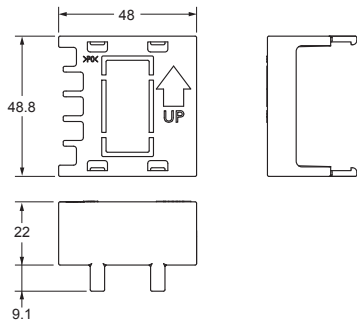
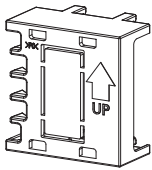

### Terminal Covers

#### E53-COV23 (Three Covers provided.)

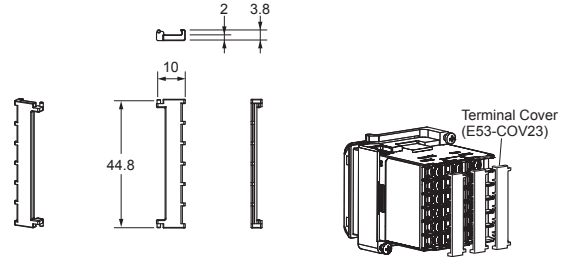

### Terminal Cover (for the P3GA-11 Back-connecting Socket)

#### Y92A-48G

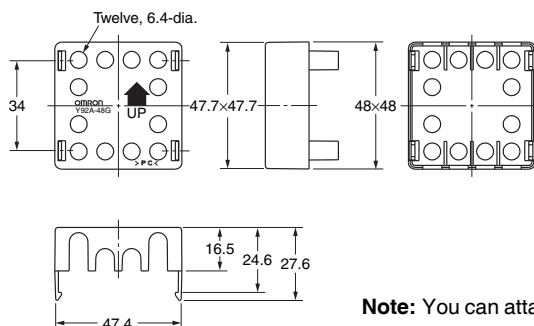
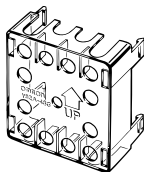

**Note:** You can attach the P3GA-11 Back-connecting Socket for finger protection.



**Waterproof Packing**  
Y92S-P8 (for DIN 48 × 48)

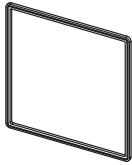

The Waterproof Packing is provided only with the E5CC/E5CC-B. It is not included with the E5CC-U. Order the Waterproof Packing separately if it becomes lost or damaged. The Waterproof Packing can be used to achieve an IP66 degree of protection. (Deterioration, shrinking, or hardening of the waterproof packing may occur depending on the operating environment. Therefore, periodic replacement is recommended to ensure the level of waterproofing specified in IP66. The time for periodic replacement depends on the operating environment. Be sure to confirm this point at your site. Consider three years as a rough standard.) The E5CC-U cannot be waterproofed even if the Waterproof Packing is attached.

**Current Transformers**

**E54-CT1**

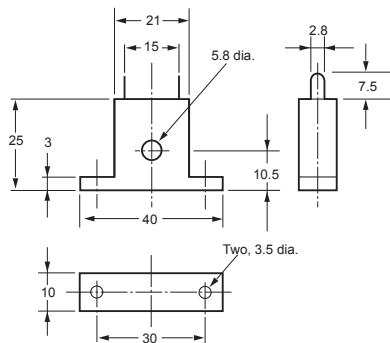
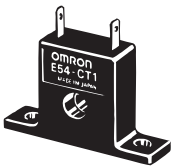

**Thru-current (Io) vs. Output Voltage (Eo) (Reference Values)**

**E54-CT1**

Maximum continuous heater current: 50 A (50/60 Hz)  
Number of windings: 400±2  
Winding resistance: 18±2 Ω

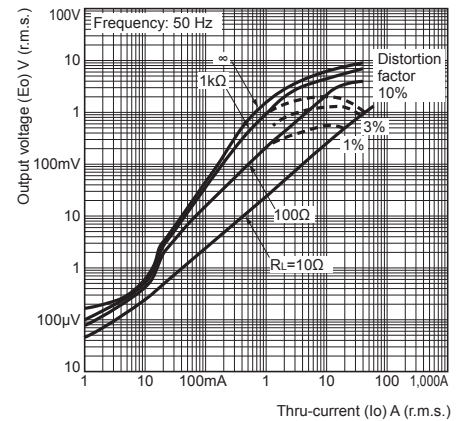

**E54-CT3**

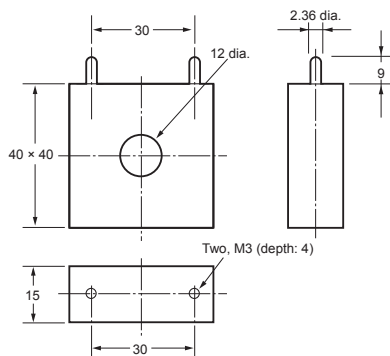

**Thru-current (Io) vs. Output Voltage (Eo) (Reference Values)**

**E54-CT3**

Maximum continuous heater current: 120 A (50/60 Hz)  
(Maximum continuous heater current for an OMRON Digital Temperature Controller is 50 A.)  
Number of windings: 400±2  
Winding resistance: 8±0.8 Ω

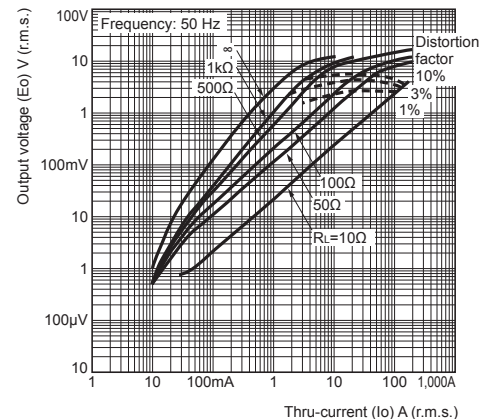

**E54-CT3 Accessories**

• **Armature**

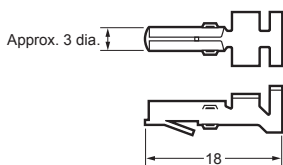

• **Plug**

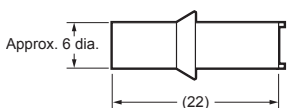

**Connection Example**

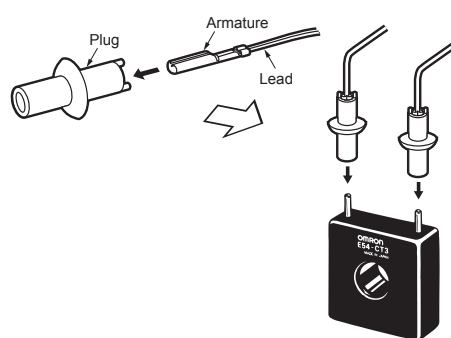

## Adapter

### Y92F-45

- Note:**
1. Use this Adapter when the Front Panel has already been prepared for the E5B□.
  2. Only black is available.
  3. You cannot use the E58-CIFQ2 USB-Serial Conversion Cable if you use the Y92F-45 Adapter. To use the USB-Serial Conversion Cable to make the settings, do so before you mount the Temperature Controller in the panel.
  4. You cannot use it together with the Y92F-49 Adapter that is enclosed with the Controller.

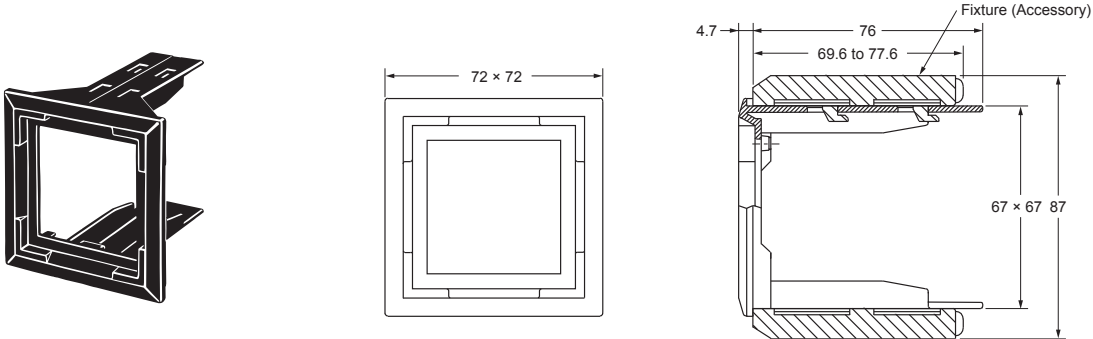

### Mounted to E5CC

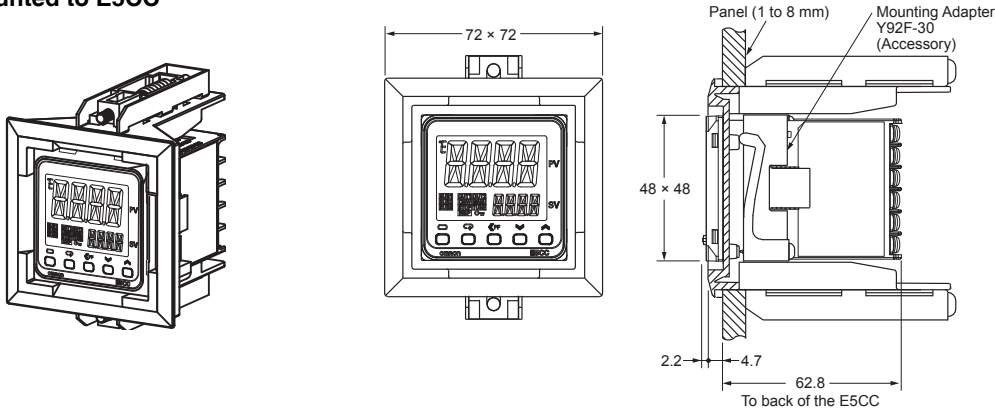

## DIN Track Mounting Adapter

### Y92F-52

- Note:**
1. This Adapter cannot be used together with the Terminal Cover. Remove the Terminal Cover to use the Adapter.
  2. This Adapter cannot be used with the E5CC-B.

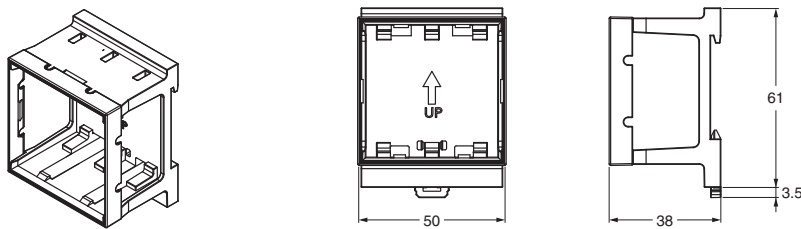

This Adapter is used to mount the E5CC to a DIN Track. If you use the Adapter, there is no need for a plate to mount in the panel or to drill mounting holes in the panel.

### Mounted to E5CC

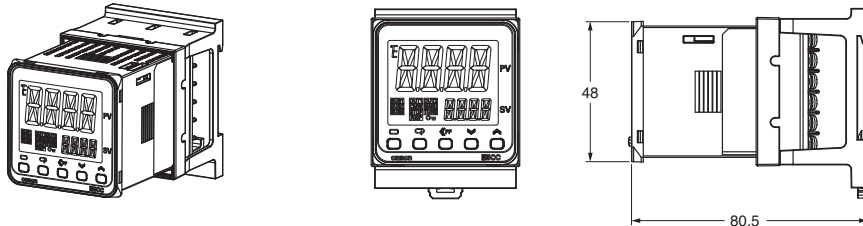

**Watertight Cover**  
Y92A-48N

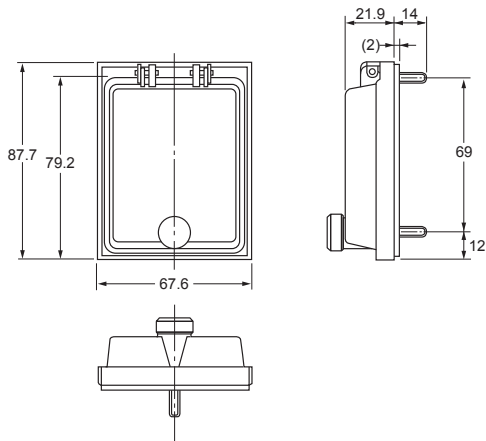

**Mounting Adapter**  
Y92F-49

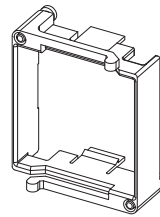

The Mounting Adapter is provided with the Temperature Controller. Order this Adapter separately if it becomes lost or damaged.

**Protective Cover**  
Y92A-48D

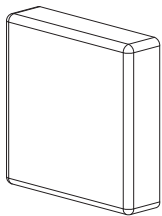

**Note:** This Protective Cover cannot be used if the Waterproof Packing is installed.

This Protective Cover is soft type. It is able to operate the controller with using this cover.

**Protective Cover**  
Y92A-48H

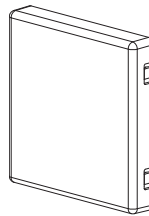

This Protective Cover is hard type. Please use it for the mis-operation prevention etc.

**E5CC-U Wiring Socket**

**Front-connecting Socket**  
P2CF-11

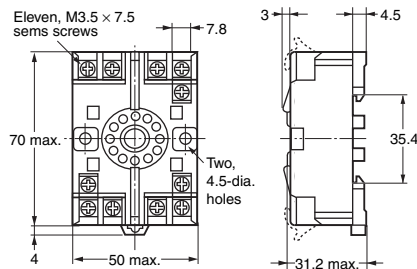
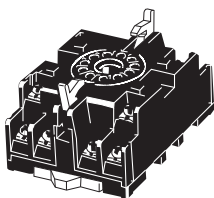

**Terminal Layout/Internal Connections**  
(Top View)

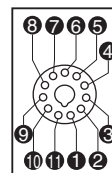

**Mounting Holes**

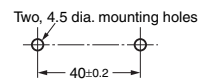

**Note:** Can also be mounted to a DIN track

- Note:** 1. A model with finger protection (P2CF-11-E) is also available.  
2. You cannot use the P2CF-11 or P2CF-11-E together with the Y92F-45.

**Back-connecting Socket**  
P3GA-11

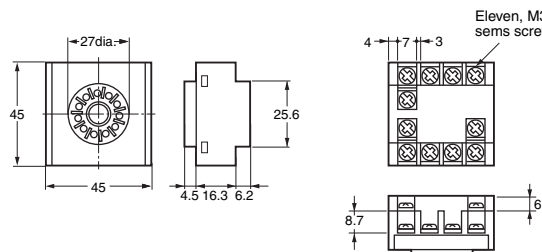
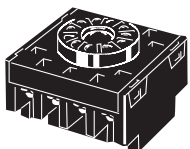

**Terminal Layout/Internal Connections**  
(Bottom View)

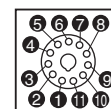

- Note:** 1. Using any other sockets will adversely affect accuracy. Use only the specified sockets.  
2. A Protective Cover for finger protection (Y92A-48G) is also available.  
3. You cannot use the P3GA-11 together with the Y92F-45.

# Digital Temperature Controller

# E5EC/E5EC-B/E5AC

(48 × 96 mm/96 × 96 mm)

**Large White PV Display That's Easier to Read.  
Easy to Use, from Model Selection to  
Setup and Operation.**

**Models with Push-In Plus Terminal  
Blocks Added to 48 × 96-mm Lineup.**

- A white LCD PV display with a height of approx. 18 mm for the E5EC/E5EC-B and 25 mm for the E5AC improves visibility.
- High-speed sampling at 50 ms.
- With 48 x 96-mm Controllers, you can select between screw terminal blocks or Push-In Plus terminal blocks to save wiring work.
- Short body with depth of only 60 mm. (Screw Terminal Blocks)
- Easy connections to a PLC with programless communications. Use component communications to link Temperature Controllers to each other.
- Tool ports are provided both on the top panel and the front panel. Set up the Controller without wiring the power supply by connecting to the computer with a Communications Conversion Cable (sold separately). Setup is easy with the CX-Thermo (sold separately).



\* CSA conformance evaluation by UL.



48 × 96 mm  
Screw Terminal  
Blocks  
E5EC

48 × 96 mm  
Push-In Plus  
Terminal  
Blocks  
E5EC-B

96 × 96 mm  
Screw Terminal  
Blocks  
E5AC

Refer to your OMRON website for the most recent information on applicable safety standards.

**Refer to Safety Precautions on page 108.**

## Main I/O Functions

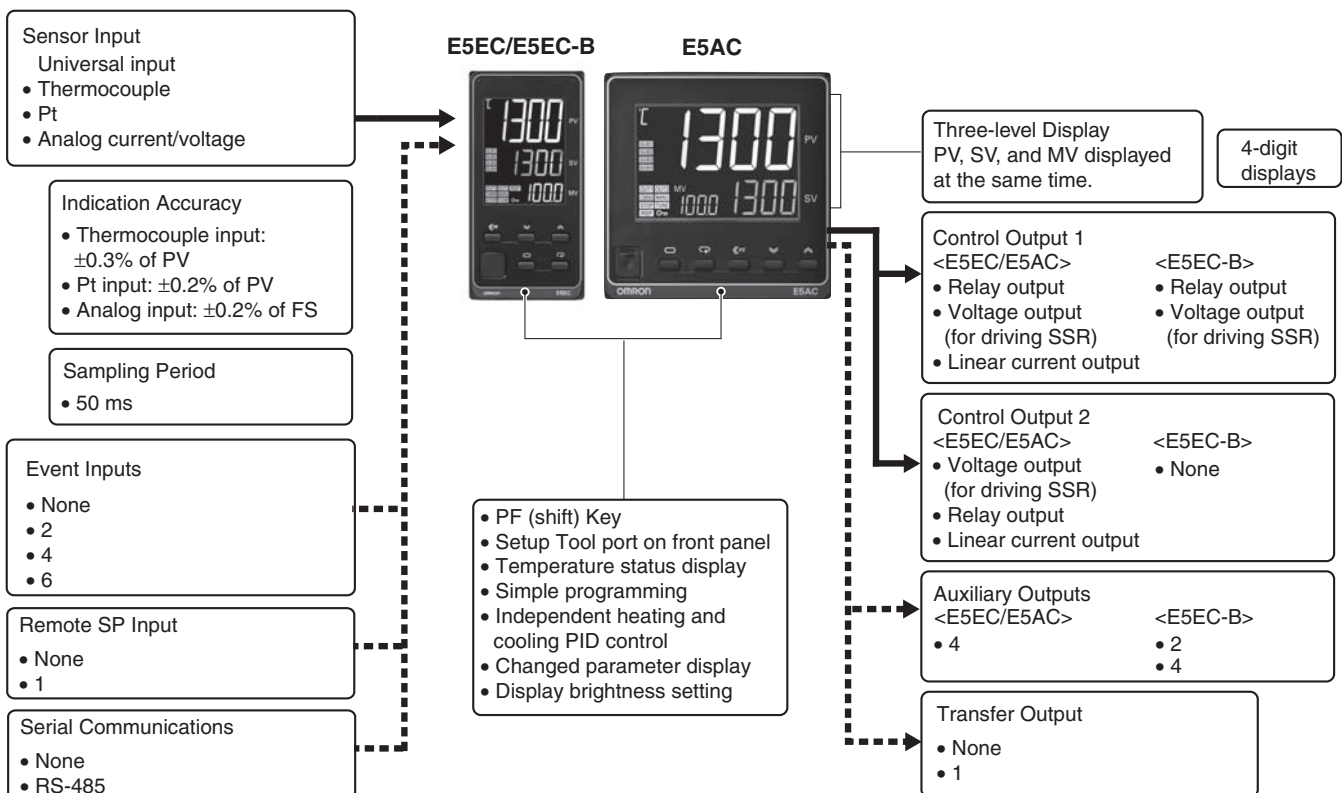

This datasheet is provided as a guideline for selecting products.

Be sure to refer to the following manuals for application precautions and other information required for operation before attempting to use the product.

E5□C Digital Temperature Controllers User's Manual (Cat. No. H174)

E5□C Digital Temperature Controllers Communications Manual (Cat. No. H175)

## Model Number Legend and Standard Models

### Model Number Legend

Models with Screw Terminal Blocks

E5EC-□□ 4 □ 5 M-□□□□ (Example: E5EC-RX4A5M-000)

① ② ③ ④ ⑤ ⑥

E5AC-□□ 4 □ 5 M-□□□□ (Example: E5AC-RX4A5M-000)

① ② ③ ④ ⑤ ⑥

| Model | ①                       | ②                        | ③                    | ④             | ⑤          | ⑥       | Meaning                            |   |
|-------|-------------------------|--------------------------|----------------------|---------------|------------|---------|------------------------------------|---|
|       | Control outputs 1 and 2 | No. of auxiliary outputs | Power supply voltage | Terminal type | Input type | Options | Control output 1                   | Control output 2  |
| E5EC  |                         |                          |                      |               |            |         | 48 × 96 mm                         |   |
| E5AC  |                         |                          |                      |               |            |         | 96 × 96 mm                         |   |
| *2    | RX                      |                          |                      |               |            |         | Relay output                       | None  |
|       | QX                      |                          |                      |               |            |         | Voltage output (for driving SSR)   | None  |
|       | CX                      |                          |                      |               |            |         | Linear current output              | None  |
|       | QQ                      |                          |                      |               |            |         | Voltage output (for driving SSR)   | Voltage output (for driving SSR)  |
|       | QR                      |                          |                      |               |            |         | Voltage output (for driving SSR)   | Relay output  |
|       | RR                      |                          |                      |               |            |         | Relay output                       | Relay output  |
|       | *2 CC                   |                          |                      |               |            |         | Linear current output              | Linear current output   |
|       | *2 CQ                   |                          |                      |               |            |         | Linear current output              | Voltage output (for driving SSR)  |
|       | PR                      |                          |                      |               |            |         | Position-proportional relay output | Position-proportional relay output  |
|       |                         |                          | *3 4                 |               |            |         |                                    | 4 (auxiliary outputs 1 and 2 with same common and auxiliary outputs 3 and 4 with same common) |
|       |                         |                          | A                    |               |            |         | 100 to 240 VAC                     |   |
|       |                         |                          | D                    |               |            |         | 24 VAC/DC                          |   |
|       |                         |                          |                      | 5             |            |         | Screw terminal blocks (with cover) |   |
|       |                         |                          |                      |               | M          |         | Universal input                    |   |

| Option selection conditions *1 | Control outputs 1 and 2       |              |            |     | HB alarm and HS alarm   | Communications | Event inputs | Remote SP Input | Transfer output |
|--------------------------------|-------------------------------|--------------|------------|-----|-------------------------|----------------|--------------|-----------------|-----------------|
|                                | For RX, QX, QQ, QR, RR, or CQ | For CX or CC | For PR     |     |                         |                |              |                 |                 |
|                                | Selectable                    | Selectable   | Selectable | 000 | ---                     | ---            | ---          | ---             | ---             |
|                                |                               | Selectable   | Selectable | 004 | ---                     | RS-485         | 2            | ---             | ---             |
|                                |                               | Selectable   |            | 005 | ---                     | ---            | 4            | ---             | ---             |
|                                | Selectable                    |              |            | 009 | 2 (for 3-phase heaters) | RS-485         | 2            | ---             | ---             |
|                                | Selectable                    |              |            | 010 | 1                       | ---            | 4            | ---             | ---             |
|                                | Selectable                    |              |            | 011 | 1                       | ---            | 6            | Provided.       | Provided.       |
|                                |                               | Selectable   |            | 013 | ---                     | ---            | 6            | Provided.       | Provided.       |
|                                |                               | Selectable   | Selectable | 014 | ---                     | RS-485         | 4            | Provided.       | Provided.       |

\*1. The options that can be selected depend on the type of control output.

\*2. The control output cannot be used as a transfer output.

\*3. A model with four auxiliary outputs must be selected.

Note: Draw-out-type models of the E5EC and E5AC are available. Ask your OMRON representative for details.

## Heating and Cooling Control

### Using Heating and Cooling Control

#### ① Control Output Assignment

If there is no control output 2, an auxiliary output is used as the cooling control output.

If there is a control output 2, the two control outputs are used for heating and cooling.

(It does not matter which output is used for heating and which output is used for cooling.)

#### ② Control

If PID control is used, you can set PID control separately for heating and cooling.

This allows you to handle control systems with different heating and cooling response characteristics.

## Model Number Legend

### Models with Push-In Plus Terminal Blocks

E5EC-□□ □□ B M -□□□ (Example: E5EC-RX4ABM-000)

① ② ③ ④ ⑤ ⑥

| Model | ①                       | ②                        | ③                    | ④             | ⑤          | ⑥       | Meaning   |                |              |                  |                 |           |  |  |
|-------|-------------------------|--------------------------|----------------------|---------------|------------|---------|---|----------------|--------------|------------------|-----------------|-----------|--|--|
|       | Control outputs 1 and 2 | No. of auxiliary outputs | Power supply voltage | Terminal type | Input type | Options |   |                |              |                  |                 |           |  |  |
| E5EC  |                         |                          |                      |               |            |         | 48 × 96 mm  |                |              |                  |                 |           |  |  |
|       |                         |                          |                      |               |            |         | Control output 1  |                |              | Control output 2 |                 |           |  |  |
|       | RX                      |                          |                      |               |            |         | Relay output  |                |              | None             |                 |           |  |  |
|       | QX                      |                          |                      |               |            |         | Voltage output (for driving SSR)  |                |              | None             |                 |           |  |  |
|       |                         | 2                        |                      |               |            |         | 2 independent points  |                |              |                  |                 |           |  |  |
|       |                         | 4                        |                      |               |            |         | 4 (auxiliary outputs 1 and 2 with same common and auxiliary outputs 3 and 4 with same common) |                |              |                  |                 |           |  |  |
|       |                         |                          | A                    |               |            |         | 100 to 240 VAC  |                |              |                  |                 |           |  |  |
|       |                         |                          | D                    |               |            |         | 24 VAC/DC   |                |              |                  |                 |           |  |  |
|       |                         |                          |                      | B             |            |         | Push-in plus terminal blocks  |                |              |                  |                 |           |  |  |
|       |                         |                          |                      |               | M          |         | Universal input   |                |              |                  |                 |           |  |  |
|       |                         |                          |                      |               |            |         | HB alarm and HS alarm   | Communications | Event inputs | Remote SP Input  | Transfer output |           |  |  |
|       |                         |                          |                      |               |            |         | 000   | ---            | ---          | ---              | ---             |           |  |  |
|       |                         |                          |                      |               |            |         | 008   | 1              | RS-485       | 2                | ---             |           |  |  |
|       |                         |                          |                      |               |            |         | 010   | 1              | ---          | 4                | ---             |           |  |  |
|       |                         |                          |                      |               |            |         | 011   | 1              | ---          | 6                | Provided.       | Provided. |  |  |

## Heating and Cooling Control

### Using Heating and Cooling Control

#### ① Control Output Assignment

An auxiliary output is used as the cooling control output.

#### ② Control

If PID control is used, you can set PID control separately for heating and cooling.

This allows you to handle control systems with different heating and cooling response characteristics.

## Optional Products (Order Separately)

### USB-Serial Conversion Cable

| Model     |
|-----------|
| E58-CIFQ2 |

### Communications Conversion Cable

| Model       |
|-------------|
| E58-CIFQ2-E |

**Note:** Always use this product together with the E58-CIFQ2. This Cable is used to connect to the front-panel Setup Tool port.

### Terminal Covers (for E5EC/E5AC)

| Model            |
|------------------|
| E53-COV24 (3pcs) |

**Note:** The Terminal Covers E53-COV24 are provided with the Digital Temperature Controller.

### Waterproof Packing

| Applicable Controller | Model    |
|-----------------------|----------|
| E5EC/E5EC-B           | Y92S-P9  |
| E5AC                  | Y92S-P10 |

**Note:** This Waterproof Packing is provided with the Digital Temperature Controller.

### Waterproof Cover

| Applicable Controller | Model    |
|-----------------------|----------|
| E5EC/E5EC-B           | Y92A-49N |
| E5AC                  | Y92A-96N |

### Front Port Cover

| Model   |
|---------|
| Y92S-P7 |

**Note:** This Front Port Cover is provided with the Digital Temperature Controller.

### Mounting Adapter

| Model          |
|----------------|
| Y92F-51 (2pcs) |

**Note:** This Mounting Adapter is provided with the Digital Temperature Controller.

### Current Transformers (CTs)

| Hole diameter | Model   |
|---------------|---------|
| 5.8 mm        | E54-CT1 |
| 12.0 mm       | E54-CT3 |

### CX-Thermo Support Software

| Model       |
|-------------|
| EST2-2C-MV4 |

**Note:** CX-Thermo version 4.5 or higher is required for the E5EC/E5AC.  
CX-Thermo version 4.65 or higher is required for the E5EC-B. For the system requirements for the CX-Thermo, refer to information on the EST2-2C-MV4 on the OMRON website ([www.ia.omron.com](http://www.ia.omron.com)).

# E5EC/E5EC-B/E5AC

## Specifications

### Ratings

|                                      |  |   |
|--------------------------------------|--|---|
| <b>Power supply voltage</b>          |  | A in model number: 100 to 240 VAC, 50/60 Hz<br>D in model number: 24 VAC, 50/60 Hz; 24 VDC  |
| <b>Operating voltage range</b>       |  | 85 to 110% of rated supply voltage  |
| <b>Power consumption</b>             | <b>E5EC/<br/>E5EC-B</b>                      | Models with option selection of 000: 6.6 VA max. at 100 to 240 VAC, and 4.1 VA max. at 24 VAC or 2.3 W max. at 24 VDC<br>All other models: 8.3 VA max. at 100 to 240 VAC, and 5.5 VA max. at 24 VAC or 3.2 W max. at 24 VDC   |
|                                      | <b>E5AC</b>                                  | Models with option selection of 000: 7.0 VA max. at 100 to 240 VAC, and 4.2 VA max. at 24 VAC or 2.4 W max. at 24 VDC<br>All other models: 9.0 VA max. at 100 to 240 VAC, and 5.6 VA max. at 24 VAC or 3.4 W max. at 24 VDC   |
| <b>Sensor input</b>                  |  | Temperature input<br>Thermocouple: K, J, T, E, L, U, N, R, S, B, W, or PL II<br>Platinum resistance thermometer: Pt100 or JPt100<br>Infrared temperature sensor (ES1B): 10 to 70°C, 60 to 120°C, 115 to 165°C, or 140 to 260°C<br>Analog input<br>Current input: 4 to 20 mA or 0 to 20 mA<br>Voltage input: 1 to 5 V, 0 to 5 V, or 0 to 10 V  |
| <b>Input impedance</b>               |  | Current input: 150 Ω max., Voltage input: 1 MΩ min.<br>(Use a 1:1 connection when connecting the ES2-HB/THB.)   |
| <b>Control method</b>                |  | ON/OFF or 2-PID control (with auto-tuning)  |
| <b>Control output</b>                | <b>Relay output</b>                          | SPST-NO, 250 VAC, 5 A (resistive load), electrical life: 100,000 operations, minimum applicable load: 5 V, 10 mA (reference value)  |
|                                      | <b>Voltage output (for driving SSR)</b>      | Output voltage: 12 VDC ±20% (PNP), max. load current: 40 mA, with short-circuit protection circuit (The maximum load current is 21 mA for models with two control outputs.)   |
|                                      | <b>Linear current output *</b>               | 4 to 20 mA DC/0 to 20 mA DC, load: 500 Ω max., resolution: approx. 10,000   |
| <b>Auxiliary output</b>              | <b>Number of outputs</b>                     | E5EC/E5AC: 4<br>E5EC-B: 2 or 4 (depends on model)   |
|                                      | <b>Output specifications</b>                 | SPST-NO. relay outputs, 250 VAC, Models with 2 outputs: 3 A (resistive load), Models with 4 outputs: 2 A (resistive load), Electrical life: 100,000 operations, Minimum applicable load: 10 mA at 5 V (reference value)   |
| <b>Event input</b>                   | <b>Number of inputs</b>                      | 2, 4 or 6 (depends on model)  |
|                                      | <b>External contact input specifications</b> | Contact input: ON: 1 kΩ max., OFF: 100 kΩ min.<br>Non-contact input: ON: Residual voltage: 1.5 V max., OFF: Leakage current: 0.1 mA max.<br>Current flow: Approx. 7 mA per contact  |
| <b>Transfer output</b>               | <b>Number of outputs</b>                     | 1 (only on models with a transfer output)   |
|                                      | <b>Output specifications</b>                 | Current output: 4 to 20 mA DC, Load: 500 Ω max., Resolution: Approx. 10,000<br>Linear voltage output: 1 to 5 VDC, load: 1 kΩ min., Resolution: Approx. 10,000   |
| <b>Remote SP input</b>               |  | Current input: 4 to 20 mA DC or 0 to 20 mA DC (input impedance: 150 Ω max.)<br>Voltage input: 1 to 5 V, 0 to 5 V, or 0 to 10 V (input impedance: 1 MΩ min.)   |
| <b>Potentiometer input *</b>         |  | 100 Ω to 10 kΩ  |
| <b>Setting method</b>                |  | Digital setting using front panel keys  |
| <b>Indication method</b>             |  | 11-segment digital display and individual indicators<br>Character height: E5EC/E5EC-B: PV: 18.0 mm, SV: 11.0 mm, MV: 7.8 mm<br>E5AC: PV: 25.0 mm, SV: 15.0 mm, MV: 9.5 mm<br>Three displays Contents: PV/SV/MV, PV/SV/Multi-SP, or PV/SV/Remaining soak time, etc<br>Numbers of digits: 4 digits each for PM, SV, and MV displays   |
| <b>Multi SP</b>                      |  | Up to eight set points (SP0 to SP7) can be saved and selected using the event inputs, key operations, or serial communications.   |
| <b>Bank switching</b>                |  | None  |
| <b>Other functions</b>               |  | Manual output, heating/cooling control, loop burnout alarm, SP ramp, other alarm functions, heater burnout (HB) alarm (including SSR failure (HS) alarm), 40% AT, 100% AT, MV limiter, input digital filter, self tuning, robust tuning, PV input shift, run/stop, protection functions, extraction of square root, MV change rate limit, logic operations, temperature status display, simple programming, moving average of input value, and display brightness setting |
| <b>Ambient operating temperature</b> |  | -10 to 55°C (with no condensation or icing), For 3-year warranty: -10 to 50°C with standard mounting (with no condensation or icing)  |
| <b>Ambient operating humidity</b>    |  | 25 to 85%   |
| <b>Storage temperature</b>           |  | -25 to 65°C (with no condensation or icing)   |
| <b>Altitude</b>                      |  | 2,000 m max.  |
| <b>Recommended fuse</b>              |  | T2A, 250 VAC, time-lag, low-breaking capacity   |
| <b>Installation environment</b>      |  | Overvoltage category II, Pollution Degree 2 (EN/IEC/UL 61010-1)   |

\* This function is not supported by the E5EC-B. Refer to *Model Number Legend* on page 38.





## Alarm Types

Each alarm can be independently set to one of the following 19 alarm types. The default is 2: Upper limit. (see note.)

Auxiliary outputs are allocated for alarms. ON delays and OFF delays (0 to 999 s) can also be specified.

**Note:** In the default settings for models with HB or HS alarms, alarm 1 is set to a heater alarm (HA) and the Alarm Type 1 parameter is not displayed.

To use alarm 1, set the output assignment to alarm 1.

| Set value   | Alarm type                                       | Alarm output operation                   |  | Description of function  |
|-------------|--|--|--|--|
|             |  | When alarm value X is positive           | When alarm value X is negative           |  |
| 0           | Alarm function OFF                               | Output OFF                               |  | No alarm   |
| 1           | Upper- and lower-limit *1                        |  | *2                                       | Set the upward deviation in the set point for the alarm upper limit (H) and the lower deviation in the set point for the alarm lower limit (L). The alarm is ON when the PV is outside this deviation range. |
| 2 (default) | Upper-limit                                      |  |  | Set the upward deviation in the set point by setting the alarm value (X). The alarm is ON when the PV is higher than the SP by the deviation or more.  |
| 3           | Lower-limit                                      |  |  | Set the downward deviation in the set point by setting the alarm value (X). The alarm is ON when the PV is lower than the SP by the deviation or more.   |
| 4           | Upper- and lower-limit range *1                  |  | *3                                       | Set the upward deviation in the set point for the alarm upper limit (H) and the lower deviation in the set point for the alarm lower limit (L). The alarm is ON when the PV is inside this deviation range.  |
| 5           | Upper- and lower-limit with standby sequence *1  | *5                                       | *4                                       | A standby sequence is added to the upper- and lower-limit alarm (1). *6  |
| 6           | Upper-limit with standby sequence                |  |  | A standby sequence is added to the upper-limit alarm (2). *6   |
| 7           | Lower-limit with standby sequence                |  |  | A standby sequence is added to the lower-limit alarm (3). *6   |
| 8           | Absolute-value upper-limit                       |  |  | The alarm will turn ON if the process value is larger than the alarm value (X) regardless of the set point.  |
| 9           | Absolute-value lower-limit                       |  |  | The alarm will turn ON if the process value is smaller than the alarm value (X) regardless of the set point.   |
| 10          | Absolute-value upper-limit with standby sequence |  |  | A standby sequence is added to the absolute-value upper-limit alarm (8). *6  |
| 11          | Absolute-value lower-limit with standby sequence |  |  | A standby sequence is added to the absolute-value lower-limit alarm (9). *6  |
| 12          | LBA (alarm 1 type only)                          | -  |  | *7   |
| 13          | PV change rate alarm                             | -  |  | *8   |
| 14          | SP absolute-value upper-limit alarm              |  |  | This alarm type turns ON the alarm when the set point (SP) is higher than the alarm value (X).   |
| 15          | SP absolute-value lower-limit alarm              |  |  | This alarm type turns ON the alarm when the set point (SP) is lower than the alarm value (X).  |
| 16          | MV absolute-value upper-limit alarm *9           | Standard Control<br>                     | Standard Control<br>                     | This alarm type turns ON the alarm when the manipulated variable (MV) is higher than the alarm value (X).  |
|             |  | Heating/Cooling Control (Heating MV)<br> | Heating/Cooling Control (Heating MV)<br> |  |
|             |  | Always ON                                |  |  |
| 17          | MV absolute-value lower-limit alarm *9           | Standard Control<br>                     | Standard Control<br>                     | This alarm type turns ON the alarm when the manipulated variable (MV) is lower than the alarm value (X).   |
|             |  | Heating/Cooling Control (Cooling MV)<br> | Heating/Cooling Control (Cooling MV)<br> |  |
|             |  | Always ON                                |  |  |
| 18          | RSP absolute-value upper-limit alarm *10         |  |  | This alarm type turns ON the alarm when the remote SP (RSP) is higher than the alarm value (X).  |
| 19          | RSP absolute-value lower-limit alarm *10         |  |  | This alarm type turns ON the alarm when the remote SP (RSP) is lower than the alarm value (X).   |

\*1. With set values 1, 4 and 5, the upper and lower limit values can be set independently for each alarm type, and are expressed as "L" and "H."

\*2. Set value: 1, Upper- and lower-limit alarm

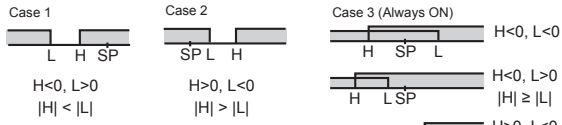

\*3. Set value: 4, Upper- and lower-limit range

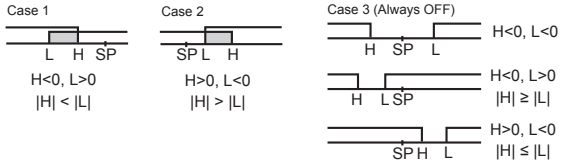

\*4. Set value: 5, Upper- and lower-limit with standby sequence  
For Upper- and Lower-Limit Alarm Described Above \*2

- Case 1 and 2  
Always OFF when the upper-limit and lower-limit hysteresis overlaps.
- Case 3: Always OFF

\*5. Set value: 5, Upper- and lower-limit with standby sequence  
Always OFF when the upper-limit and lower-limit hysteresis overlaps.

\*6. Refer to the *E5□C Digital Temperature Controllers User's Manual* (Cat. No. H174) for information on the operation of the standby sequence.

\*7. Refer to the *E5□C Digital Temperature Controllers User's Manual* (Cat. No. H174) for information on the loop burnout alarm (LBA). This setting cannot be used with a position-proportional model.

\*8. Refer to the *E5□C Digital Temperature Controllers User's Manual* (Cat. No. H174) for information on the PV change rate alarm.

\*9. When heating/cooling control is performed, the MV absolute upper limit alarm functions only for the heating operation and the MV absolute lower limit alarm functions only for the cooling operation.

\*10. This value is displayed only when a remote SP input is used. It functions in both Local SP Mode and Remote SP Mode.

## Characteristics

|   |   |   |
|---|---|---|
| <b>Indication accuracy (at the ambient temperature of 23°C)</b> | Thermocouple: (±0.3% of indication value or ±1°C, whichever is greater) ±1 digit max. *1<br>Platinum resistance thermometer: (±0.2% of indication value or ±0.8°C, whichever is greater) ±1 digit max.<br>Analog input: ±0.2% FS ±1 digit max.<br>CT input: ±5% FS ±1 digit max.<br>Potentiometer input: ±5% FS ±1 digit max.   |   |
| <b>Transfer output accuracy</b>                                 | ±0.3% FS max.   |   |
| <b>Remote SP Input Type</b>                                     | ±0.2% FS ±1 digit max.  |   |
| <b>Influence of temperature *2</b>                              | Thermocouple input (R, S, B, W, PL II): (±1% of indication value or ±10°C, whichever is greater) ±1 digit max.<br>Other thermocouple input: (±1% of indication value or ±4°C, whichever is greater) ±1 digit max. *3  |   |
| <b>Influence of voltage *2</b>                                  | Platinum resistance thermometer: (±1% of indication value or ±2°C, whichever is greater) ±1 digit max.<br>Analog input: ±1%FS ±1 digit max.   |   |
| <b>Influence of EMS. (at EN 61326-1)</b>                        | CT input: ±5% FS ±1 digit max.<br>Remote SP input: ±1% FS ±1 digit max.   |   |
| <b>Input sampling period</b>                                    | 50ms  |   |
| <b>Hysteresis</b>   | Temperature input: 0.1 to 999.9°C or °F (in units of 0.1°C or °F)<br>Analog input: 0.01% to 99.99% FS (in units of 0.01% FS)  |   |
| <b>Proportional band (P)</b>                                    | Temperature input: 0.1 to 999.9°C or °F (in units of 0.1°C or °F)<br>Analog input: 0.1 to 999.9% FS (in units of 0.1% FS)   |   |
| <b>Integral time (I)</b>  | Standard, heating/cooling, or Position-proportional (Close): 0 to 9999 s (in units of 1 s), 0.0 to 999.9 s (in units of 0.1 s)<br>Position-proportional (Floating): 1 to 9999 s (in units of 1 s), 0.1 to 999.9 s (in units of 0.1 s)*4   |   |
| <b>Derivative time (D)</b>                                      | 0 to 9999 s (in units of 1 s), 0.0 to 999.9 s (in units of 0.1 s) *4  |   |
| <b>Proportional band (P) for cooling</b>                        | Temperature input: 0.1 to 999.9°C or °F (in units of 0.1°C or °F)<br>Analog input: 0.1 to 999.9% FS (in units of 0.1% FS)   |   |
| <b>Integral time (I) for cooling</b>                            | 0 to 9999 s (in units of 1 s), 0.0 to 999.9 s (in units of 0.1 s) *4  |   |
| <b>Derivative time (D) for cooling</b>                          | 0 to 9999 s (in units of 1 s), 0.0 to 999.9 s (in units of 0.1 s) *4  |   |
| <b>Control period</b>   | 0.1, 0.2, 0.5, 1 to 99 s (in units of 1 s)  |   |
| <b>Manual reset value</b>                                       | 0.0 to 100.0% (in units of 0.1%)  |   |
| <b>Alarm setting range</b>                                      | -1999 to 9999 (decimal point position depends on input type)  |   |
| <b>Influence of signal source resistance</b>                    | Thermocouple: 0.1°C/Ω max. (100 Ω max.)<br>Platinum resistance thermometer: 0.1°C/Ω max. (10 Ω max.)  |   |
| <b>Insulation resistance</b>                                    | 20 MΩ min. (at 500 VDC)   |   |
| <b>Dielectric strength</b>                                      | 3,000 VAC, 50/60 Hz for 1 min between terminals of different charge   |   |
| <b>Vibration</b>  | <b>Malfunction</b>  | 10 to 55 Hz, 20 m/s <sup>2</sup> for 10 min each in X, Y, and Z directions  |
|   | <b>Resistance</b>   | 10 to 55 Hz, 20 m/s <sup>2</sup> for 2 hrs each in X, Y, and Z directions   |
| <b>Shock</b>  | <b>Malfunction</b>  | 100 m/s <sup>2</sup> , 3 times each in X, Y, and Z directions   |
|   | <b>Resistance</b>   | 300 m/s <sup>2</sup> , 3 times each in X, Y, and Z directions   |
| <b>Weight</b>   | E5EC/E5EC-B: Controller: Approx. 210 g, Adapter: Approx. 4 g × 2<br>E5AC: Controller: Approx. 250 g, Adapter: Approx. 4 g × 2   |   |
| <b>Degree of protection</b>                                     | Front panel: IP66, Rear case: IP20, Terminals: IP00   |   |
| <b>Memory protection</b>  | Non-volatile memory (number of writes: 1,000,000 times)   |   |
| <b>Setup Tool</b>   | E5EC/E5AC: CX-Thermo version 4.5 or higher<br>E5EC-B: CX-Thermo version 4.65 or higher  |   |
| <b>Setup Tool port</b>  | E5EC/E5EC-B/E5AC top panel: An E58-CIFQ2 USB-Serial Conversion Cable is used to connect to a USB port on the computer.*5<br>E5EC/E5EC-B/E5AC front panel: An E58-CIFQ2 USB-Serial Conversion Cable and E58-CIFQ2-E Conversion Cable are used together to connect to a USB port on the computer.*5   |   |
| <b>Standards</b>  | <b>Approved standards</b>   | cULus: UL 61010-1/CSA C22.2 No.61010-1, Korean wireless regulations (Radio law: KC Mark) (Some models only.) *6, Lloyd's standards *7 |
|   | <b>Conformed standards</b>  | EN 61010-1 (IEC 61010-1)  |
| <b>EMC</b>  | EMI<br>Radiated Interference Electromagnetic Field Strength: EN 61326-1 *8<br>Noise Terminal Voltage: EN 55011 Group 1, class A<br>EMS:<br>ESD Immunity: EN 55011 Group 1, class A<br>Electromagnetic Field Immunity: EN 61326-1 *8<br>Burst Noise Immunity: EN 61000-4-2<br>Conducted Disturbance Immunity: EN 61000-4-3<br>Surge Immunity: EN 61000-4-4<br>Voltage Dip/Interrupting Immunity: EN 61000-4-6<br>EN 61000-4-5<br>EN 61000-4-11 |   |

\*1. The indication accuracy of K thermocouples in the -200 to 1,300°C range, T and N thermocouples at a temperature of -100°C max., and U and L thermocouples at any temperatures is ±2°C ±1 digit max. The indication accuracy of the B thermocouple at a temperature of 400°C max. is not specified. The indication accuracy of B thermocouples at a temperature of 400 to 800°C is ±3°C max. The indication accuracy of the R and S thermocouples at a temperature of 200°C max. is ±3°C ±1 digit max. The indication accuracy of W thermocouples is (±0.3% of PV or ±3°C, whichever is greater) ±1 digit max. The indication accuracy of PL II thermocouples is (±0.3% of PV or ±2°C, whichever is greater) ±1 digit max.

\*2. Ambient temperature: -10°C to 23°C to 55°C, Voltage range: -15% to 10% of rated voltage

\*3. K thermocouple at -100°C max.: ±10°C max.

\*4. The unit is determined by the setting of the Integral/Derivative Time Unit parameter.

\*5. External communications (RS-485) and USB-serial conversion cable communications can be used at the same time.

\*6. Refer to your OMRON website for the most recent information on applicable models.

\*7. Refer to information on maritime standards in *Shipping Standards* on page 110 for compliance with Lloyd's Standards.

\*8. Industrial electromagnetic environment (EN/IEC 61326-1 Table 2)

## USB-Serial Conversion Cable

|                               |   |
|-------------------------------|---|
| Applicable OS                 | Windows XP/Vista/7/8/10 *1  |
| Applicable software           | E5EC/E5AC: CX-Thermo version 4.5 or higher<br>E5EC-B: CX-Thermo version 4.65 or higher            |
| Applicable models             | E5□C-T Series, E5□C Series, and E5CB Series   |
| USB interface standard        | Conforms to USB Specification 2.0.  |
| DTE speed                     | 38,400 bps  |
| Connector specifications      | Computer: USB (type A plug)<br>Digital Temperature Controller:<br>Special serial connector        |
| Power supply                  | Bus power (Supplied from USB host controller.) *2   |
| Power supply voltage          | 5 VDC   |
| Current consumption           | 450 mA max.   |
| Output voltage                | 4.7±0.2 VDC<br>(Supplied from USB-Serial Conversion Cable to the Digital Temperature Controller.) |
| Output current                | 250 mA max.<br>(Supplied from USB-Serial Conversion Cable to the Digital Temperature Controller.) |
| Ambient operating temperature | 0 to 55°C (with no condensation or icing)   |
| Ambient operating humidity    | 10% to 80%  |
| Storage temperature           | -20 to 60°C (with no condensation or icing)   |
| Storage humidity              | 10% to 80%  |
| Altitude                      | 2,000 m max.  |
| Weight                        | Approx. 120 g   |

Windows is a registered trademark of Microsoft Corporation in the United States and/or other countries.

\*1. CX-Thermo version 4.65 or higher runs on Windows 10.

\*2. Use a high-power port for the USB port.

**Note:** A driver must be installed on the computer. Refer to the *Instruction Manual* included with the Cable for the installation procedure.

## Communications Specifications

|                                     |   |
|-------------------------------------|---|
| Transmission line connection method | RS-485: Multidrop   |
| Communications                      | RS-485 (two-wire, half duplex)  |
| Synchronization method              | Start-stop synchronization  |
| Protocol                            | CompoWay/F, or Modbus   |
| Baud rate *                         | 9600, 19200, 38400, or 57600 bps  |
| Transmission code                   | ASCII   |
| Data bit length *                   | 7 or 8 bits   |
| Stop bit length *                   | 1 or 2 bits   |
| Error detection                     | Vertical parity (none, even, odd)<br>Block check character (BCC) with CompoWay/F or CRC-16 Modbus |
| Flow control                        | None  |
| Interface                           | RS-485  |
| Retry function                      | None  |
| Communications buffer               | 217 bytes   |
| Communications response wait time   | 0 to 99 ms<br>Default: 20 ms  |

\* The baud rate, data bit length, stop bit length, and vertical parity can be individually set using the Communications Setting Level.

## Communications Functions

|                               |   |
|-------------------------------|---|
| Programless communications *1 | You can use the memory in the PLC to read and write E5□C parameters, start and stop operation, etc. The E5□C automatically performs communications with PLCs. No communications programming is required. Number of connected Digital Temperature Controllers: 32 max. (Up to 16 for the FX Series)<br>Applicable PLCs<br>OMRON PLCs<br>CS Series, CJ Series, or CP Series<br>Mitsubishi Electric PLCs<br>MELSEC Q Series, L Series, or FX Series (compatible with the FX2 or FX3 (excluding the FX1S))<br>KEYENCE PLCs<br>KEYENCE KV Series |
|-------------------------------|---|

|                             |   |
|-----------------------------|---|
| Component Communications *1 | When Digital Temperature Controllers are connected, set points and RUN/STOP commands can be sent from the Digital Temperature Controller that is set as the master to the Digital Temperature Controllers that are set as slaves. Slope and offsets can be set for the set point. Number of connected Digital Temperature Controllers: 32 max. (including master) |
| Copying *2                  | When Digital Temperature Controllers are connected, the parameters can be copied from the Digital Temperature Controller that is set as the master to the Digital Temperature Controllers that are set as slaves.   |

MELSEC is a registered trademark of Mitsubishi Electric Corporation. KEYENCE is a registered trademark of Keyence Corporation.

\*1. A Temperature Controller with version 1.1 or higher is required. A Temperature Controller with version 2.1 or higher is required for the FX Series or the KV Series.

\*2. Both the programless communications and the component communications support the copying.

## Current Transformer (Order Separately) Ratings

|                            |   |
|----------------------------|---|
| Dielectric strength        | 1,000 VAC for 1 min                               |
| Vibration resistance       | 50 Hz, 98 m/s <sup>2</sup>                        |
| Weight                     | E54-CT1: Approx. 11.5 g,<br>E54-CT3: Approx. 50 g |
| Accessories (E54-CT3 only) | Armatures (2)<br>Plugs (2)                        |

## Heater Burnout Alarms and SSR Failure Alarms

|   |  |
|---|--|
| CT input (for heater current detection) | Models with detection for singlephase heaters: One input<br>Models with detection for singlephase or three-phase heaters: Two inputs |
| Maximum heater current                  | 50 A AC  |
| Input current indication accuracy       | ±5% FS ±1 digit max.   |
| Heater burnout alarm setting range *1   | 0.1 to 49.9 A (in units of 0.1 A)<br>Minimum detection ON time: 100 ms *3  |
| SSR failure alarm setting range *2      | 0.1 to 49.9 A (in units of 0.1 A)<br>Minimum detection OFF time: 100 ms *4   |

\*1. For heater burnout alarms, the heater current will be measured when the control output is ON, and the output will turn ON if the heater current is lower than the set value (i.e., heater burnout detection current value).

\*2. For SSR failure alarms, the heater current will be measured when the control output is OFF, and the output will turn ON if the heater current is higher than the set value (i.e., SSR failure detection current value).

\*3. The value is 30 ms for a control period of 0.1 s or 0.2 s.

\*4. The value is 35 ms for a control period of 0.1 s or 0.2 s.

## Electrical Life Expectancy Curve for Relays (Reference Values)

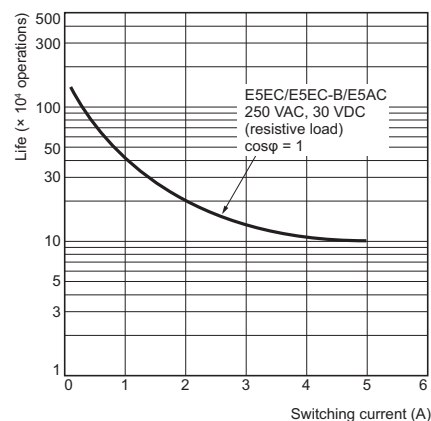

# E5EC/E5EC-B/E5AC

## External Connections

### E5EC/E5AC (Screw Terminal Blocks)

E5EC-□□ 4 □ 5 M - □□□□  
 (1) (2) (3) (4) (5) (6)

E5AC-□□ 4 □ 5 M - □□□□  
 (1) (2) (3) (4) (5) (6)

Terminal type

Terminal type

The E5EC is set for a K-type thermocouple (input type = 5) by default. An input error (SEPR) will occur if the input type setting does not agree with the temperature sensor. Check the input type.

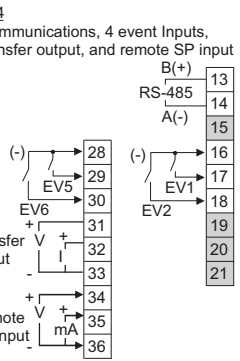
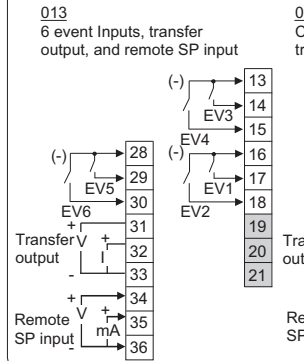
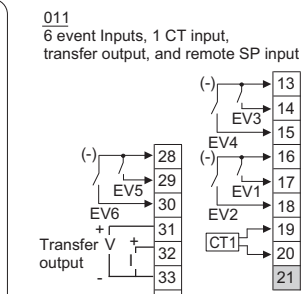
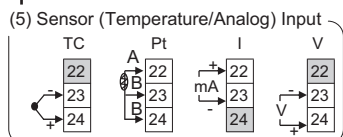
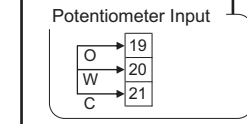
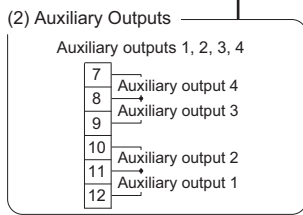
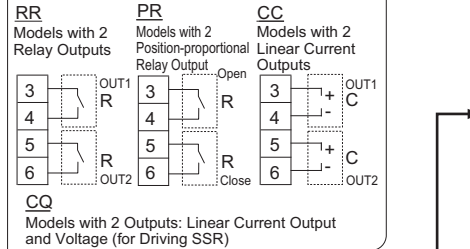
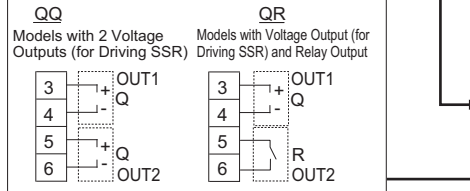
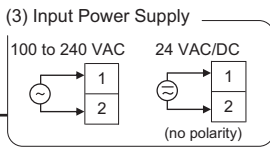
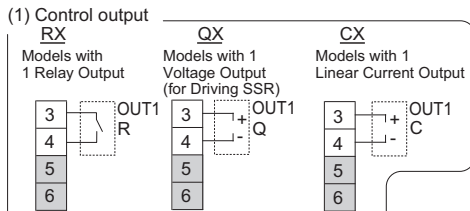
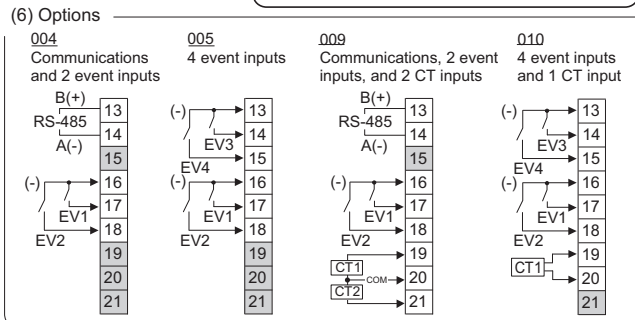
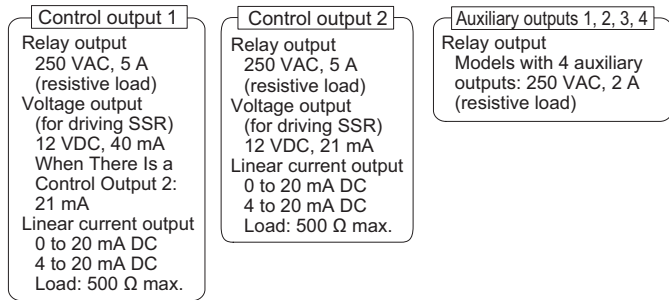

Use no-voltage inputs for the event inputs. The polarity for non-contact inputs is given in parentheses.

- Note:**
1. The application of the terminals depends on the model.
  2. Do not wire the terminals that are shown with a gray background.
  3. When complying with EMC standards, the cable that connects the sensor must be 30 m or less. If the cable length exceeds 30 m, compliance with EMC standards will not be possible.
  4. Connect M3 crimped terminals.

E5EC-B (Push-In Plus Terminal Blocks)

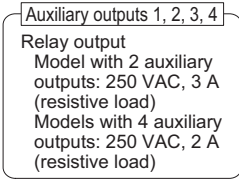
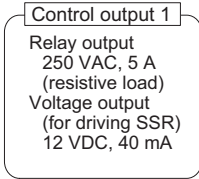
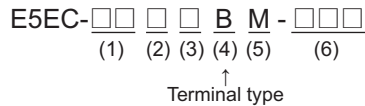

The E5EC is set for a K-type thermocouple (input type = 5) by default. An input error (5ERR) will occur if the input type setting does not agree with the temperature sensor. Check the input type.

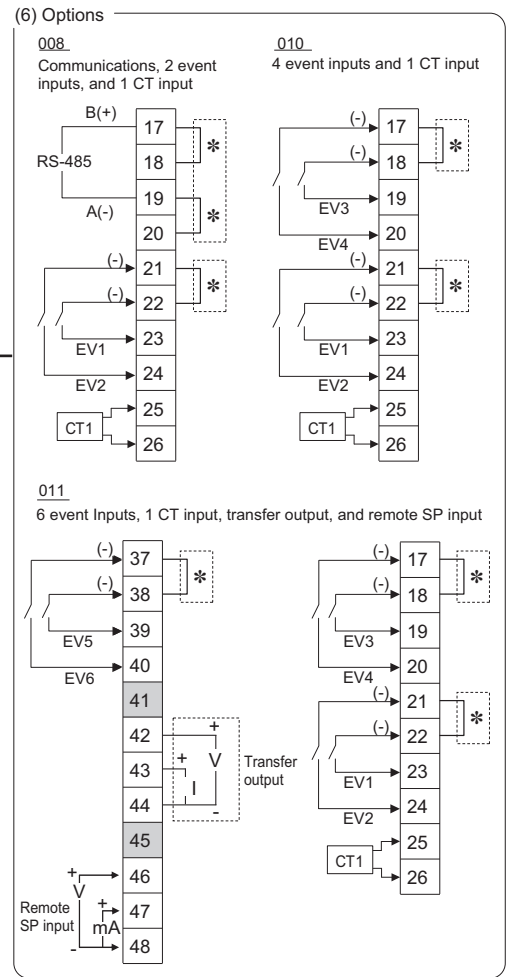
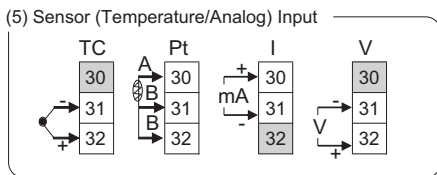
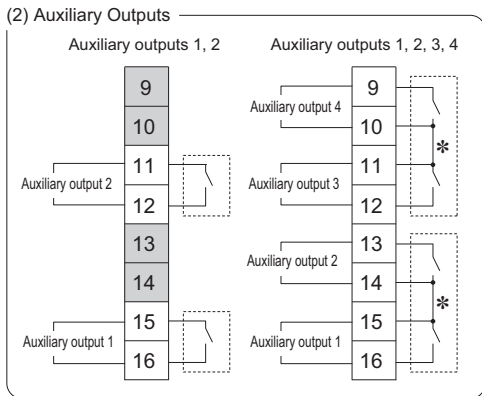
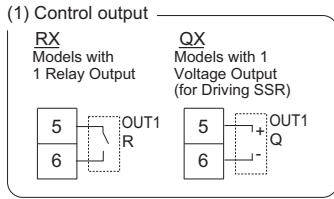
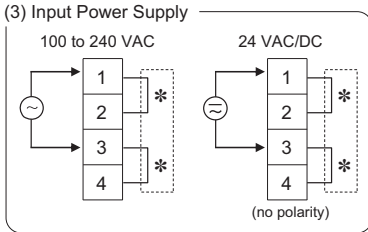

Use no-voltage inputs for the event inputs.  
 The polarity for non-contact inputs is given in parentheses.

- Note:**
- The application of the terminals depends on the model.
  - Do not wire the terminals that are shown with a gray background.
  - When complying with EMC standards, the cable that connects the sensor must be 30 m or less. If the cable length exceeds 30 m, compliance with EMC standards will not be possible.
  - Refer to *Wiring Precautions for E5□C-B (Controllers with Push-In Plus Terminal Blocks)* on page 116 for wire specifications and wiring methods.
  - Common terminals are indicated with asterisks (\*). You can use the input power supply and communications common terminals for crossover wiring. Do not exceed the maximum number of Temperature Controllers given below if you use crossover wiring for the input power supply.  
 100 to 240 VAC Controllers: 16 max.  
 24 VAC/VDC Controllers: 8 max.

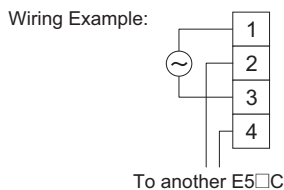



# E5EC/E5EC-B/E5AC

## Isolation/Insulation Block Diagrams

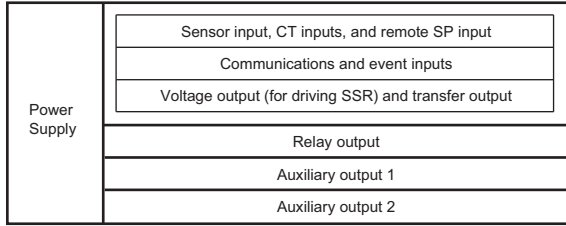

### Models with 2 Auxiliary Outputs

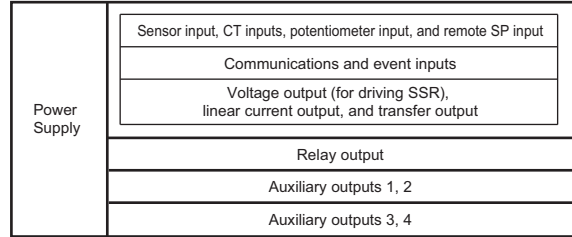

 : Reinforced insulation  
 : Functional isolation

### Models with 4 Auxiliary Outputs



 : Reinforced insulation  
 : Functional isolation

**Note:** Auxiliary outputs 1 to 2 and 3 to 4 are not insulated.

## Nomenclature

### E5EC/E5EC-B

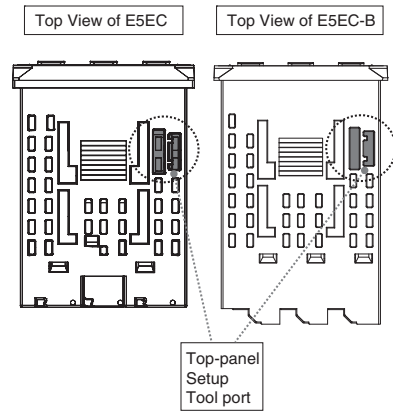
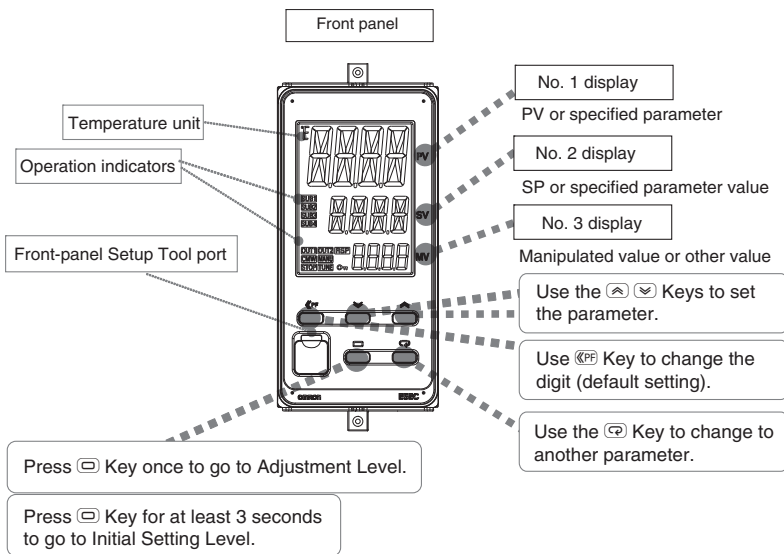

### E5AC

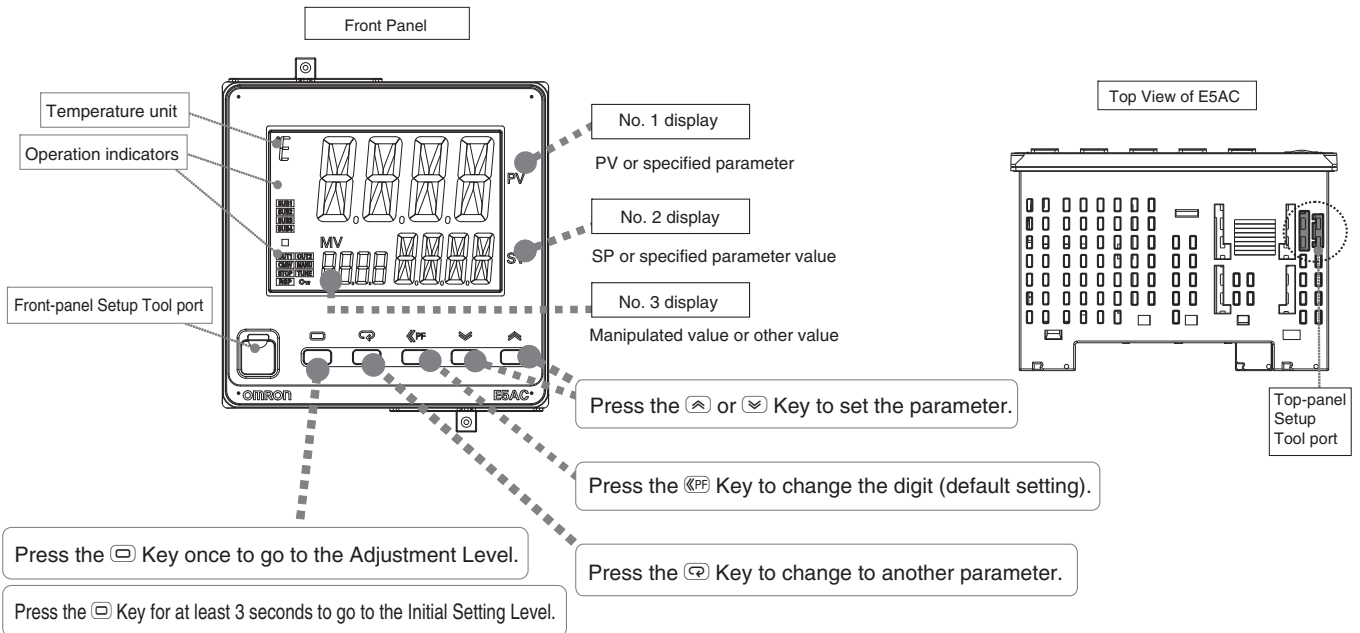



# Dimensions

## Controllers

### E5EC

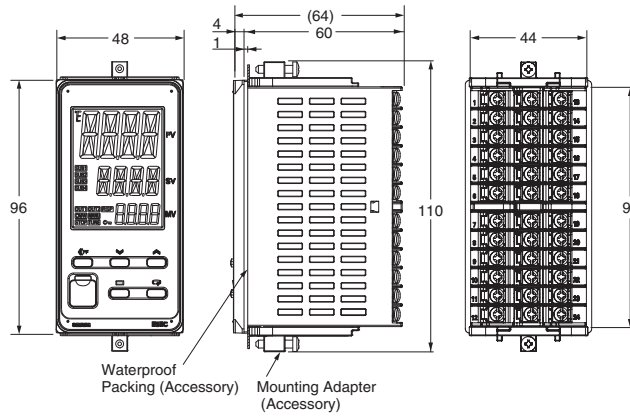

### E5EC-B

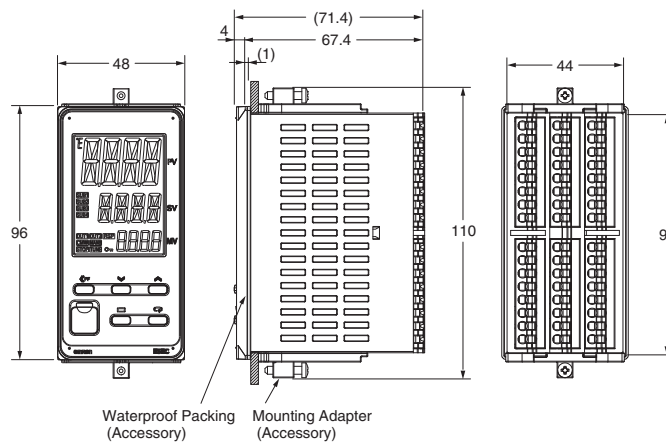

- Setup Tool ports are provided as standard feature. Use these ports to connect a computer to the Digital Temperature Controller. The E58-CIFQ2 USB-Serial Conversion Cable is required to connect to the port on the top panel. The E58-CIFQ2 USB-Serial Conversion Cable and E58-CIFQ2-E Communications Conversion Cable are required to connect to the port on the front panel. (You cannot leave either port connected constantly during operation.)

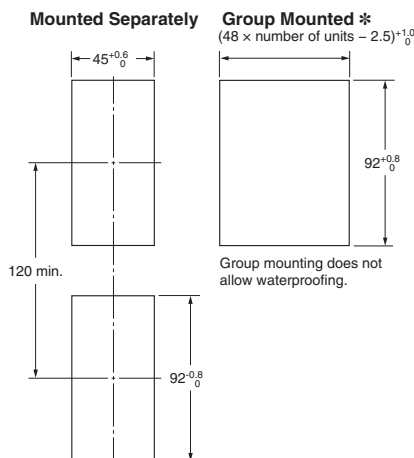

**\* E5EC:**

Selections for Control Outputs 1 and 2: QQ, QR, RR, CC, PR, or CQ  
 If you also specify 011, 013, or 014 for the option selection and use group mounting, the ambient temperature must be 45°C or less.  
 Maintain the following spacing when more than one Digital Controller is installed at an ambient temperature of 55°C.

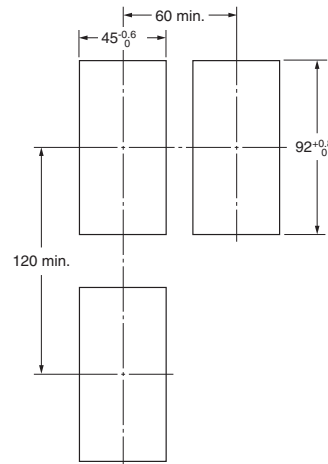

- Recommended panel thickness is 1 to 8 mm.
- Group mounting is not possible in the vertical direction. (Maintain the specified mounting space between Controllers.)
- To mount the Controller so that it is waterproof, insert the waterproof packing onto the Controller.
- When two or more Controllers are mounted, make sure that the surrounding temperature does not exceed the allowable operating temperature specified in the specifications.

## E5AC

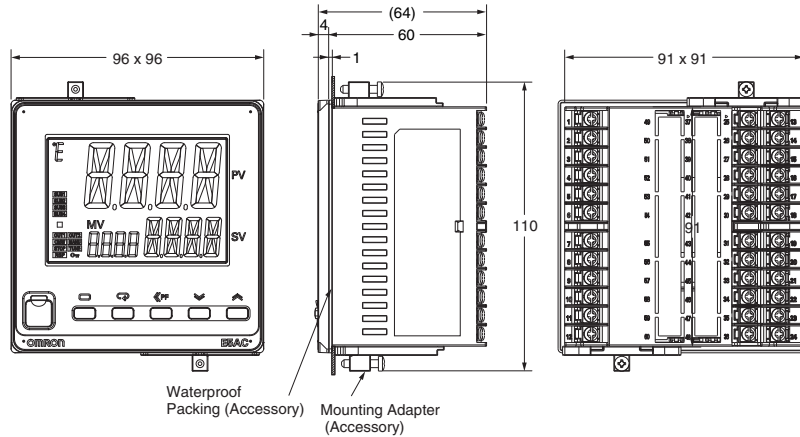

Waterproof Packing (Accessory) Mounting Adapter (Accessory)

- Setup Tool ports are provided as standard feature. Use these ports to connect a computer to the Digital Temperature Controller. The E58-CIFQ2 USB-Serial Conversion Cable is required to connect to the port on the top panel. The E58-CIFQ2 USB-Serial Conversion Cable and E58-CIFQ2-E Communications Conversion Cable are required to connect to the port on the front panel. (You cannot leave either port connected constantly during operation.)

### Mounted Separately

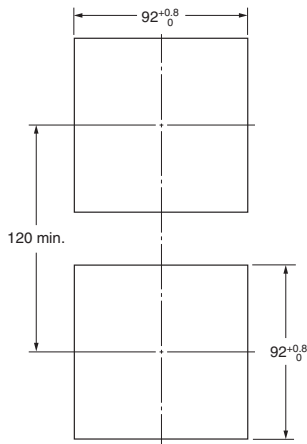

### Group Mounted

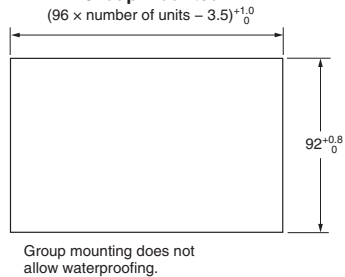

- Recommended panel thickness is 1 to 8 mm.
- Group mounting is not possible in the vertical direction. (Maintain the specified mounting space between Controllers.)
- To mount the Controller so that it is waterproof, insert the waterproof packing onto the Controller.
- When two or more Controllers are mounted, make sure that the surrounding temperature does not exceed the allowable operating temperature specified in the specifications.

**Accessories (Order Separately)**

**USB-Serial Conversion Cable**

E58-CIFQ2

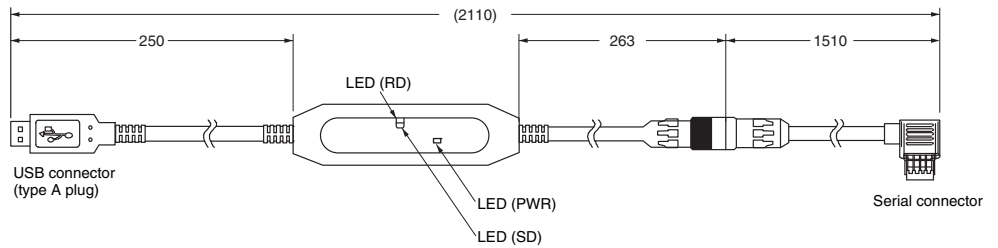

**Conversion Cable**

E58-CIFQ2-E

Conversion Cable

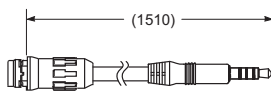

Connecting to the E58-CIFQ2 USB-Serial Conversion Cable

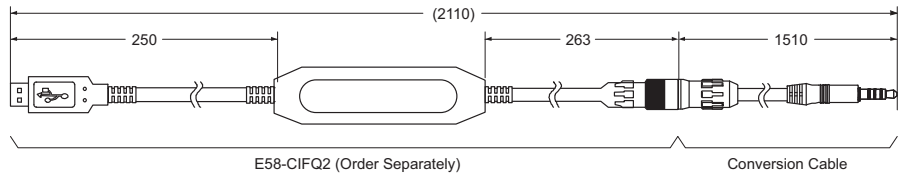

**Note:** Always use this product together with the E58-CIFQ2.

**Terminal Covers**

E53-COV24 (Three Covers provided.)

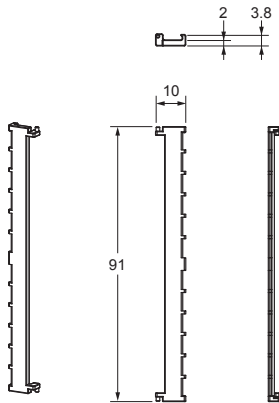

**Waterproof Packing**

Y92S-P9 (for DIN 48 × 96)

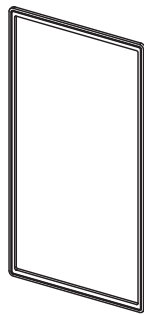

Y92S-P10 (for DIN 96 × 96)

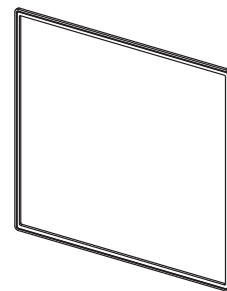

The Waterproof Packing is provided with the Temperature Controller.  
 Order the Waterproof Packing separately if it becomes lost or damaged.  
 The degree of protection when the Waterproof Packing is used is IP66.  
 Also, keep the Port Cover on the front-panel Setup Tool port of the E5EC/E5EC-B/E5AC securely closed.  
 To maintain an IP66 degree of protection, the Waterproof Packing and the Port Cover for the front-panel Setup Tool port must be periodically replaced because they may deteriorate, shrink, or harden depending on the operating environment.  
 The replacement period will vary with the operating environment.  
 Check the required period in the actual application.  
 Use 3 years or sooner as a guideline.

**Setup Tool Port Cover for top panel**

Y92S-P7

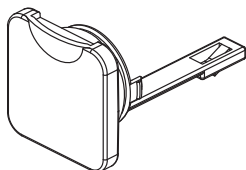

Order this Port Cover separately if the Port Cover on the front-panel Setup Tool port is lost or damaged. The Waterproof Packing must be periodically replaced because it may deteriorate, shrink, or harden depending on the operating environment.

**Mounting Adapter**

Y92F-51 (Two Adapters provided.)

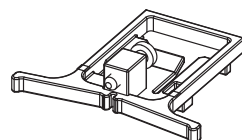

One pair is provided with the Controller.  
 Order this Adapter separately if it becomes lost or damaged.

## Watertight Cover Y92A-49N (48 × 96)

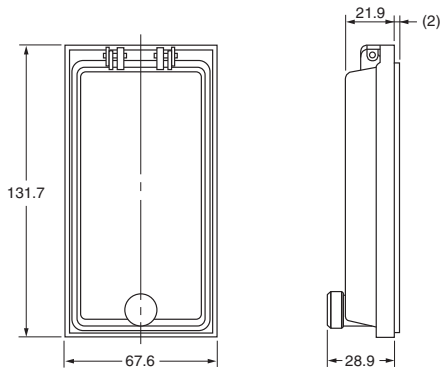

## Watertight Cover Y92A-96N (96 × 96)

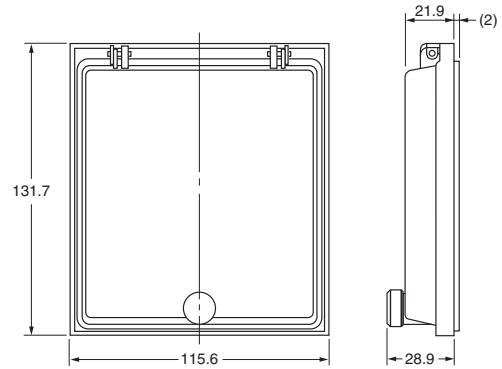

## Current Transformers

### E54-CT1

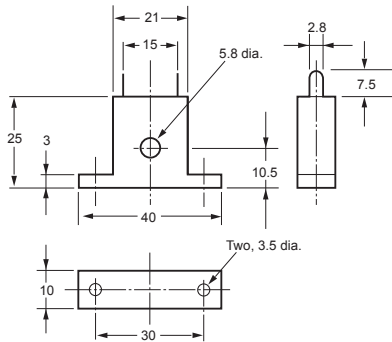

### Thru-current (I<sub>o</sub>) vs. Output Voltage (E<sub>o</sub>) (Reference Values)

#### E54-CT1

Maximum continuous heater current: 50 A (50/60 Hz)  
Number of windings: 400±2  
Winding resistance: 18±2 Ω

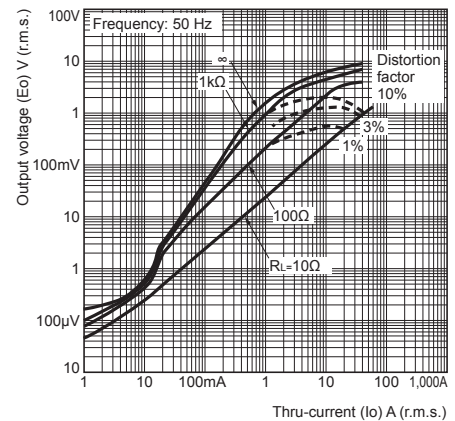

### E54-CT3

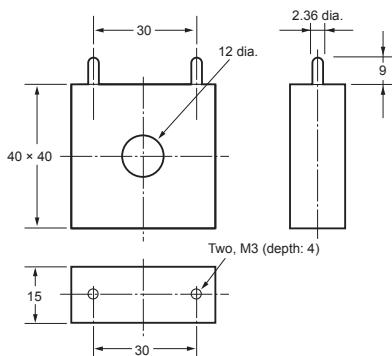

### Thru-current (I<sub>o</sub>) vs. Output Voltage (E<sub>o</sub>) (Reference Values)

#### E54-CT3

Maximum continuous heater current: 120 A (50/60 Hz)  
(Maximum continuous heater current for an OMRON Digital Temperature Controller is 50 A.)

Number of windings: 400±2  
Winding resistance: 8±0.8 Ω

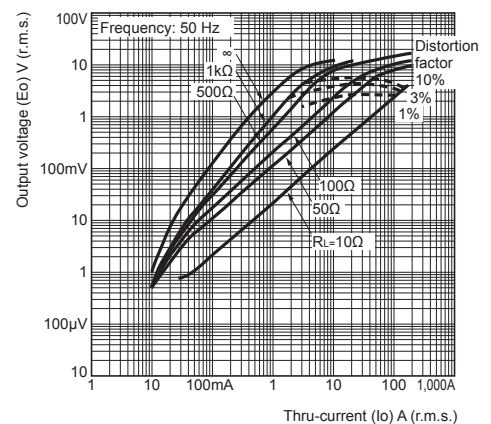

### E54-CT3 Accessories

#### • Armature

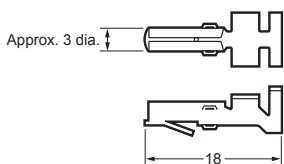

#### • Plug

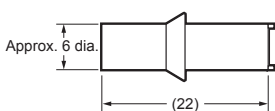

### Connection Example

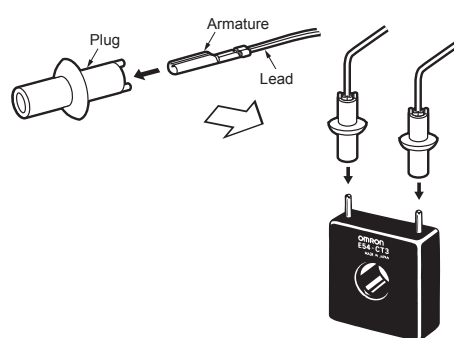



# Digital Temperature Controller

# E5DC (22.5 mm Wide, and DIN Track-mounting Type)

The E5DC Mounts to DIN Track and Is Ideal for Connections to HMIs and PLCs.

It provides the Same Easy Operation and Advanced Performance as the Rest of the E5□C Series.

- A slim body at 85 × 22.5 mm (D × W) that fits into narrow control panels and mounts to DIN Track.
- Removable terminal block for easy replacement to simplify maintenance.
- High-speed sampling at 50 ms for applications with high-speed temperature increases.
- Easy connections to a PLC with programless communications.
- Set up the Controller without wiring the power supply by connecting to the computer with a Communications Conversion Cable (sold separately). Setup is easy with the CX-Thermo (sold separately).
- Models are available with up to 2 auxiliary outputs and 1 event input to complete basic functions.
- A white PV display (height: 8.5 mm) is easy to read when setting up, checking alarms, and making settings in a control panel.



22.5 mm Wide, and DIN Track-mounting Type E5DC

Refer to your OMRON website for the most recent information on applicable safety standards.

Refer to Safety Precautions on page 108.

## Main I/O Functions

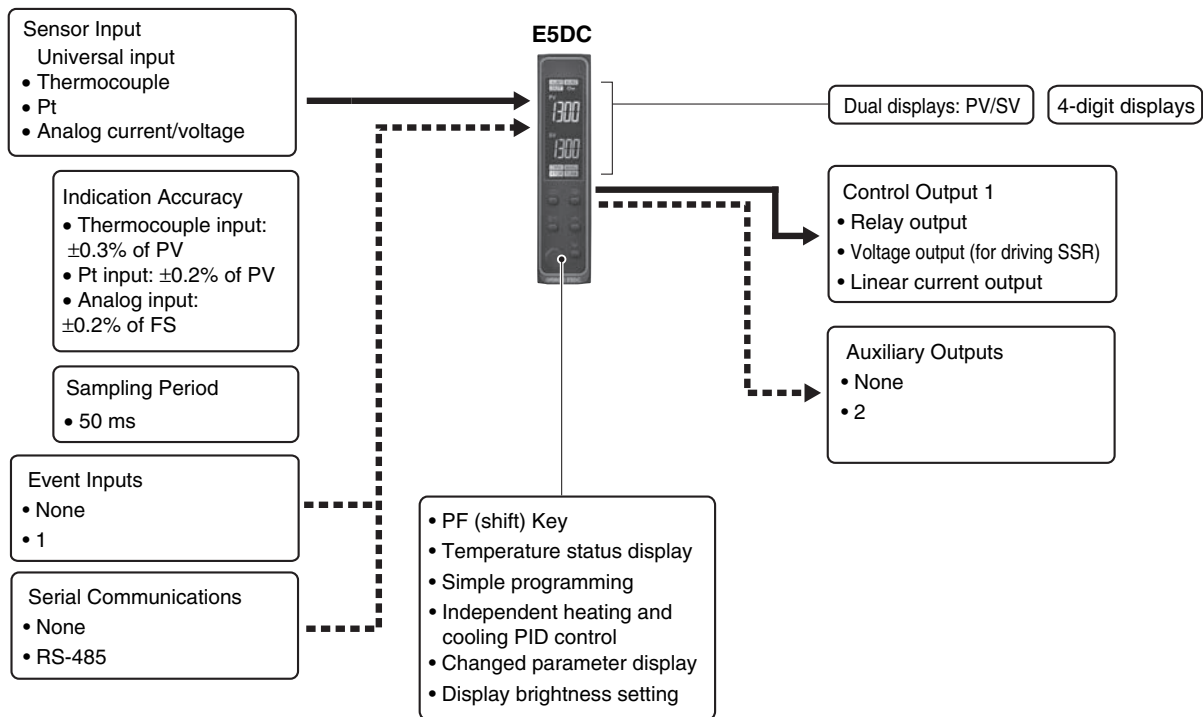

This datasheet is provided as a guideline for selecting products.

Be sure to refer to the following manuals for application precautions and other information required for operation before attempting to use the product.

E5□C Digital Temperature Controllers User's Manual (Cat. No. H174)

E5□C Digital Temperature Controllers Communications Manual (Cat. No. H175)

## Model Number Legend and Standard Models

### Model Number Legend

#### Models with Screw Terminal Blocks

E5DC-□□ □ □ □ M-□□□□ (Example: E5DC-RX0ASM-015)

① ② ③ ④ ⑤ ⑥

| Model | ①                | ②                        | ③                    | ④             | ⑤          | ⑥       | Meaning  |                         |                    |
|-------|------------------|--------------------------|----------------------|---------------|------------|---------|--|-------------------------|--------------------|
|       | Control output 1 | No. of auxiliary outputs | Power supply voltage | Terminal type | Input type | Options |  |                         |                    |
| E5DC  |                  |                          |                      |               |            |         | 22.5 mm wide and mounts to DIN Track                         |                         |                    |
|       |                  |                          |                      |               |            |         | <b>Control output 1</b>                                      | <b>Control output 2</b> |                    |
|       | RX               |                          |                      |               |            |         | Relay output   | None                    |                    |
|       | QX               |                          |                      |               |            |         | Voltage output (for driving SSR)                             | None                    |                    |
| *1    | CX               |                          |                      |               |            |         | Linear current output *1                                     | None                    |                    |
|       |                  | 0                        |                      |               |            |         | None   |                         |                    |
|       |                  | 2                        |                      |               |            |         | 2 (one common)   |                         |                    |
|       |                  |                          | A                    |               |            |         | 100 to 240 VAC   |                         |                    |
|       |                  |                          | D                    |               |            |         | 24 VAC/DC  |                         |                    |
|       |                  |                          |                      | S             |            |         | Screw terminal blocks (Main Unit and Terminal Unit together) |                         |                    |
|       |                  |                          |                      | U             |            |         | Main Unit only (no Terminal Unit)                            |                         |                    |
|       |                  |                          |                      |               | M          |         | Universal input  |                         |                    |
|       |                  |                          |                      |               |            |         | <b>HB alarm and HS alarm</b>                                 | <b>Communications</b>   | <b>Event input</b> |
|       |                  |                          |                      |               | *2         | 000     | ---  | ---                     | ---                |
|       |                  |                          |                      |               | *3         | 002     | 1  | RS-485                  | ---                |
|       |                  |                          |                      |               | *4         | 015     | ---  | RS-485                  | ---                |
|       |                  |                          |                      |               | *5         | 016     | ---  | ---                     | 1                  |
|       |                  |                          |                      |               | *3         | 017     | 1  | ---                     | 1                  |

\*1. The control output can be used as a simple transfer output for the Digital Temperature Controllers manufactured in July 2014 or later.

\*2. Option 000 can be selected only if two auxiliary outputs are selected.

\*3. Options 002 and 017 can be selected only if the control output is a relay output or voltage output and two auxiliary outputs are selected.

\*4. Option 015 cannot be selected if the control output is a relay output or voltage output and two auxiliary outputs are selected.

\*5. Options 016 can be selected only if the control output is a linear current output and two auxiliary outputs are selected.

### List of Models

| Control output                   | No. of auxiliary outputs | Options                           |                     |                | Model                                  |                                   |
|----------------------------------|--------------------------|-----------------------------------|---------------------|----------------|--|-----------------------------------|
|                                  |                          | HB alarm and HS alarm             | No. of event inputs | Communications | Power supply voltage<br>100 to 240 VAC | Power supply voltage<br>24 VAC/DC |
| Relay output                     | ---                      | ---                               | ---                 | RS-485         | E5DC-RX0ASM-015                        | E5DC-RX0DSM-015                   |
|                                  |                          |                                   |                     | ---            | E5DC-RX0AUM-015                        | E5DC-RX0DUM-015                   |
|                                  |                          |                                   |                     | ---            | E5DC-RX2ASM-000                        | E5DC-RX2DSM-000                   |
|                                  | 2                        | Detection for single-phase heater | 1                   | RS-485         | E5DC-RX2AUM-000                        | E5DC-RX2DUM-000                   |
|                                  |                          |                                   |                     | ---            | E5DC-RX2ASM-002                        | E5DC-RX2DSM-002                   |
|                                  |                          |                                   |                     | ---            | E5DC-RX2AUM-002                        | E5DC-RX2DUM-002                   |
| Voltage output (for driving SSR) | ---                      | ---                               | ---                 | RS-485         | E5DC-RX2ASM-017                        | E5DC-RX2DSM-017                   |
|                                  |                          |                                   |                     | ---            | E5DC-RX2AUM-017                        | E5DC-RX2DUM-017                   |
|                                  |                          |                                   |                     | ---            | E5DC-RX2ASM-017                        | E5DC-RX2DSM-017                   |
|                                  | 2                        | Detection for single-phase heater | 1                   | RS-485         | E5DC-QX0ASM-015                        | E5DC-QX0DSM-015                   |
|                                  |                          |                                   |                     | ---            | E5DC-QX0AUM-015                        | E5DC-QX0DUM-015                   |
|                                  |                          |                                   |                     | ---            | E5DC-QX2ASM-000                        | E5DC-QX2DSM-000                   |
| Linear current output            | ---                      | ---                               | ---                 | RS-485         | E5DC-QX2AUM-000                        | E5DC-QX2DUM-000                   |
|                                  |                          |                                   |                     | ---            | E5DC-QX2ASM-002                        | E5DC-QX2DSM-002                   |
|                                  |                          |                                   |                     | ---            | E5DC-QX2AUM-002                        | E5DC-QX2DUM-002                   |
|                                  | 2                        | ---                               | 1                   | RS-485         | E5DC-QX2ASM-017                        | E5DC-QX2DSM-017                   |
|                                  |                          |                                   |                     | ---            | E5DC-QX2AUM-017                        | E5DC-QX2DUM-017                   |
|                                  |                          |                                   |                     | ---            | E5DC-QX2ASM-017                        | E5DC-QX2DSM-017                   |
| Linear current output            | ---                      | ---                               | ---                 | RS-485         | E5DC-CX0ASM-015                        | E5DC-CX0DSM-015                   |
|                                  |                          |                                   |                     | ---            | E5DC-CX0AUM-015                        | E5DC-CX0DUM-015                   |
|                                  |                          |                                   |                     | ---            | E5DC-CX2ASM-000                        | E5DC-CX2DSM-000                   |
|                                  | 2                        | ---                               | 1                   | RS-485         | E5DC-CX2AUM-000                        | E5DC-CX2DUM-000                   |
|                                  |                          |                                   |                     | ---            | E5DC-CX2ASM-015                        | E5DC-CX2DSM-015                   |
|                                  |                          |                                   |                     | ---            | E5DC-CX2AUM-015                        | E5DC-CX2DUM-015                   |
|                                  |                          |                                   |                     | ---            | E5DC-CX2ASM-016                        | E5DC-CX2DSM-016                   |
|                                  |                          |                                   |                     | ---            | E5DC-CX2AUM-016                        | E5DC-CX2DUM-016                   |

## Heating and Cooling Control

### Using Heating and Cooling Control

#### ① Control Output Assignment

An auxiliary output is used as the cooling control output.

#### ② Control

If PID control is used, you can set PID control separately for heating and cooling.

This allows you to handle control systems with different heating and cooling response characteristics.

## Optional Products (Order Separately)

### Terminal Unit

| Model      |
|------------|
| E5DC-SCT1S |

### USB-Serial Conversion Cable

| Model     |
|-----------|
| E58-CIFQ2 |

### Communications Conversion Cable

| Model       |
|-------------|
| E58-CIFQ2-E |

**Note:** Always use this product together with the E58-CIFQ2. This Cable is used to connect to the front-panel Setup Tool port.

### Current Transformers (CTs)

| Hole diameter | Model   |
|---------------|---------|
| 5.8 mm        | E54-CT1 |
| 12.0 mm       | E54-CT3 |

### Mounting Adapter

| Model          |
|----------------|
| Y92F-53 (2pcs) |

### Short Bars

| Model            |
|------------------|
| Y92S-P11 (4 pcs) |

### CX-Thermo Support Software

| Model       |
|-------------|
| EST2-2C-MV4 |

**Note:** CX-Thermo version 4.6 or higher is required for the E5DC. For the system requirements for the CX-Thermo, refer to information on the EST2-2C-MV4 on the OMRON website ([www.ia.omron.com](http://www.ia.omron.com)).

### End Plate

| Model |
|-------|
| PFP-M |

### Spacer

| Model |
|-------|
| PFP-S |

### DIN Tracks

| Model    |
|----------|
| PFP-100N |
| PFP-50N  |

### Unit Labels

| Model   |
|---------|
| Y92S-L2 |

### End Cover

| Model   |
|---------|
| Y92F-54 |



## Specifications

### Ratings

|                                      |   |   |
|--------------------------------------|---|---|
| <b>Power supply voltage</b>          | A in model number: 100 to 240 VAC, 50/60 Hz<br>D in model number: 24 VAC, 50/60 Hz; 24 VDC  |   |
| <b>Operating voltage range</b>       | 85 to 110% of rated supply voltage  |   |
| <b>Power consumption</b>             | 4.9 VA max. at 100 to 240 VAC, and 2.8 VA max. at 24 VDC or 1.5 W max. at 24 VDC  |   |
| <b>Sensor input</b>                  | Temperature input<br>Thermocouple: K, J, T, E, L, U, N, R, S, B, W, or PL II<br>Platinum resistance thermometer: Pt100 or JPt100<br>Infrared temperature sensor (ES1B): 10 to 70°C, 60 to 120°C, 115 to 165°C, or 140 to 260°C<br>Analog input<br>Current input: 4 to 20 mA or 0 to 20 mA<br>Voltage input: 1 to 5 V, 0 to 5 V, or 0 to 10 V  |   |
| <b>Input impedance</b>               | Current input: 150 Ω max., Voltage input: 1 MΩ min. (Use a 1:1 connection when connecting the ES2-HB/THB.)  |   |
| <b>Control method</b>                | ON/OFF control or 2-PID control (with auto-tuning)  |   |
| <b>Control output</b>                | <b>Relay output</b>   | SPST-NO, 250 VAC, 3 A (resistive load), electrical life: 100,000 operations, minimum applicable load: 5 V, 10 mA (reference value)                    |
|                                      | <b>Voltage output (for driving SSR)</b>   | Output voltage 12 VDC ±20% (PNP), max. Load current: 21 mA, with short-circuit protection circuit   |
|                                      | <b>Linear current output</b>  | 4 to 20 mA DC/0 to 20 mA DC, load: 500 Ω max., resolution: Approx. 10,000   |
| <b>Auxiliary output</b>              | <b>Number of outputs</b>  | 2 (depends on model)  |
|                                      | <b>Output specifications</b>  | SPST-NO relay outputs: 250 VAC, 2 A (resistive load),<br>Electrical life: 100,000 operations, Minimum applicable load: 10 mA at 5 V (reference value) |
| <b>Event input</b>                   | <b>Number of inputs</b>   | 1 (depends on model)  |
|                                      | <b>External contact input specifications</b>  | Contact input ON: 1 kΩ max., OFF: 100 kΩ min.   |
|                                      |   | Non-contact input ON: Residual voltage 1.5 V max.; OFF: Leakage current 0.1 mA max.<br>Current flow: approx. 7 mA per contact                         |
| <b>Setting method</b>                | Digital setting using front panel keys  |   |
| <b>Indication method</b>             | 11-segment digital displays and individual indicators<br>Character height: PV: 8.5 mm, SV: 8.0 mm   |   |
| <b>Multi SP</b>                      | Up to eight set points (SP0 to SP7) can be saved and selected using the event inputs, key operations, or serial communications. *1  |   |
| <b>Bank switching</b>                | None  |   |
| <b>Other functions</b>               | Manual output, heating/cooling control, loop burnout alarm, SP ramp, other alarm functions, heater burnout (HB) alarm (including SSR failure (HS) alarm), 40% AT, 100% AT, MV limiter, input digital filter, self tuning, robust tuning, PV input shift, run/stop, protection functions, extraction of square root, MV change rate limit, logic operations, temperature status display, simple programming, moving average of input value, display brightness setting, simple transfer output, *2 and work bit message *2 |   |
| <b>Ambient operating temperature</b> | -10 to 55°C (with no condensation or icing), For 3-year warranty: -10 to 50°C with standard mounting (with no condensation or icing)  |   |
| <b>Ambient operating humidity</b>    | 25 to 85%   |   |
| <b>Storage temperature</b>           | -25 to 65°C (with no condensation or icing)   |   |
| <b>Altitude</b>                      | 2,000 m max.  |   |
| <b>Recommended fuse</b>              | T2A, 250 VAC, time-lag, low-breaking capacity   |   |
| <b>Installation environment</b>      | Overvoltage category II, Pollution Degree 2 (EN/IEC/UL 61010-1)   |   |

\*1. Only two set points are selectable for event inputs.

\*2. Usage is possible for the Digital Temperature Controllers manufactured in July 2014 or later.

## Input Ranges

### Thermocouple/Platinum Resistance Thermometer (Universal inputs)

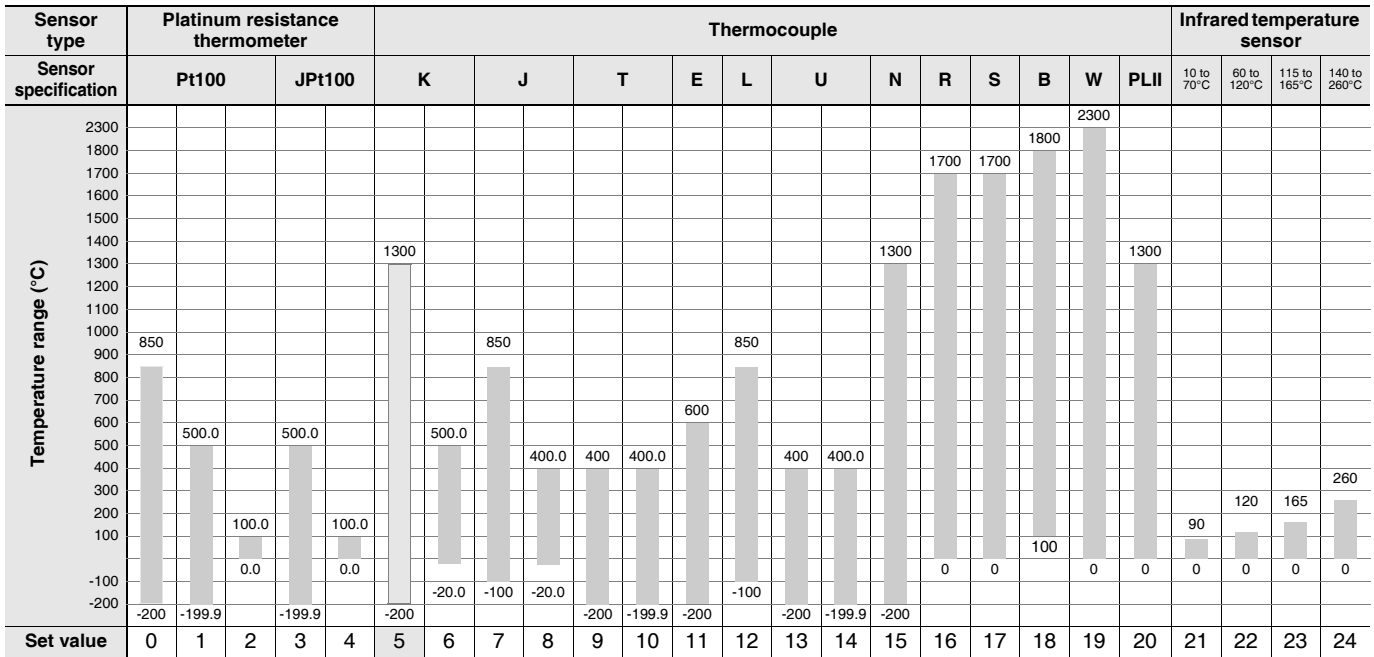

Shaded settings are the default settings.

The applicable standards for the input types are as follows:

K, J, T, E, N, R, S, B: JIS C 1602-1995, IEC 60584-1 JPt100: JIS C 1604-1989, JIS C 1606-1989

L: Fe-CuNi, DIN 43710-1985 Pt100: JIS C 1604-1997, IEC 60751

U: Cu-CuNi, DIN 43710-1985 PL II: According to Platinel II electromotive force charts from BASF (previously Engelhard)

W: W5Re/W26Re, ASTM E988-1990

### Analog input









| Input type          | Current   |            | Voltage  |          |           |
|---------------------|---|------------|----------|----------|-----------|
| Input specification | 4 to 20 mA  | 0 to 20 mA | 1 to 5 V | 0 to 5 V | 0 to 10 V |
| Setting range       | Usable in the following ranges by scaling:<br>-1999 to 9999, -199.9 to 999.9,<br>-19.99 to 99.99 or -1.999 to 9.999 |            |          |          |           |
| Set value           | 25  | 26         | 27       | 28       | 29        |

## Alarm Types

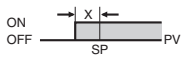
Each alarm can be independently set to one of the following 17 alarm types. The default is 2: Upper limit. (See note.)

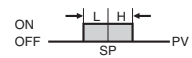
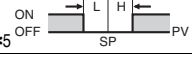
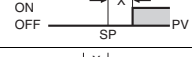
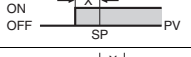
Auxiliary outputs are allocated to alarms. ON delays and OFF delays (0 to 999 s) can also be specified.

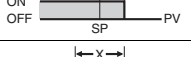
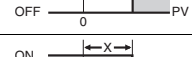
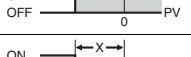
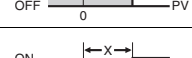
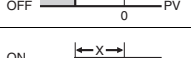
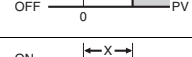
**Note:** In the default settings for models with HB or HS alarms, alarm 1 is set to a heater alarm (HA) and the Alarm Type 1 parameter is not displayed. To use alarm 1, set the output assignment to alarm 1.

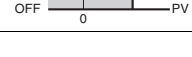
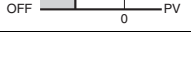
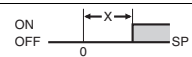
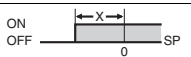
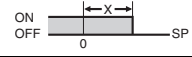
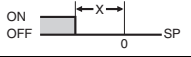
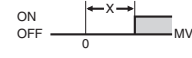
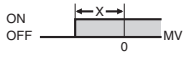
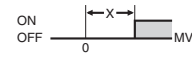
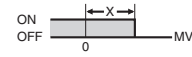
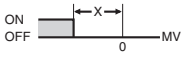
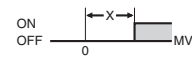
| Set value   | Alarm type                                       | Alarm output operation  |   | Description of function  |
|-------------|--|---|---|--|
|             |  | When alarm value X is positive  | When alarm value X is negative  |  |
| 0           | Alarm function OFF                               | Output OFF  |   | No alarm   |
| 1           | Upper- and lower-limit *1                        |    | *2  | Set the upward deviation in the set point for the alarm upper limit (H) and the lower deviation in the set point for the alarm lower limit (L). The alarm is ON when the PV is outside this deviation range. |
| 2 (default) | Upper-limit                                      |    |                        | Set the upward deviation in the set point by setting the alarm value (X). The alarm is ON when the PV is higher than the SP by the deviation or more.  |
| 3           | Lower-limit                                      |    |                        | Set the downward deviation in the set point by setting the alarm value (X). The alarm is ON when the PV is lower than the SP by the deviation or more.   |
| 4           | Upper- and lower-limit range *1                  |    | *3  | Set the upward deviation in the set point for the alarm upper limit (H) and the lower deviation in the set point for the alarm lower limit (L). The alarm is ON when the PV is inside this deviation range.  |
| 5           | Upper- and lower-limit with standby sequence *1  | *5   | *4  | A standby sequence is added to the upper- and lower-limit alarm (1). *6  |
| 6           | Upper-limit with standby sequence                |    |                        | A standby sequence is added to the upper-limit alarm (2). *6   |
| 7           | Lower-limit with standby sequence                |   |                       | A standby sequence is added to the lower-limit alarm (3). *6   |
| 8           | Absolute-value upper-limit                       |    |                      | The alarm will turn ON if the process value is larger than the alarm value (X) regardless of the set point.  |
| 9           | Absolute-value lower-limit                       |    |                      | The alarm will turn ON if the process value is smaller than the alarm value (X) regardless of the set point.   |
| 10          | Absolute-value upper-limit with standby sequence |    |                      | A standby sequence is added to the absolute-value upper-limit alarm (8). *6  |
| 11          | Absolute-value lower-limit with standby sequence |    |                      | A standby sequence is added to the absolute-value lower-limit alarm (9). *6  |
| 12          | LBA (alarm 1 type only)                          | -   |   | *7   |
| 13          | PV change rate alarm                             | -   |   | *8   |
| 14          | SP absolute-value upper-limit alarm              |    |                      | This alarm type turns ON the alarm when the set point (SP) is higher than the alarm value (X).   |
| 15          | SP absolute-value lower-limit alarm              |    |                      | This alarm type turns ON the alarm when the set point (SP) is lower than the alarm value (X).  |
| 16          | MV absolute-value upper-limit alarm *9           | Standard Control<br>                     | Standard Control<br> | This alarm type turns ON the alarm when the manipulated variable (MV) is higher than the alarm value (X).  |
|             |  | Heating/Cooling Control (Heating MV)<br> | Heating/Cooling Control (Heating MV)<br>Always ON   |  |
| 17          | MV absolute-value lower-limit alarm *9           | Standard Control<br>                     | Standard Control<br> | This alarm type turns ON the alarm when the manipulated variable (MV) is lower than the alarm value (X).   |
|             |  | Heating/Cooling Control (Cooling MV)<br> | Heating/Cooling Control (Cooling MV)<br>Always ON   |  |

\*1. With set values 1, 4, and 5, the upper- and lower-limit values can be set independently for each alarm type, and are expressed as "L" and "H."

\*2. Set value: 1, Upper- and lower-limit alarm

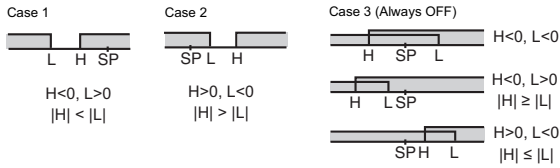

\*3. Set value: 4, Upper- and lower-limit range

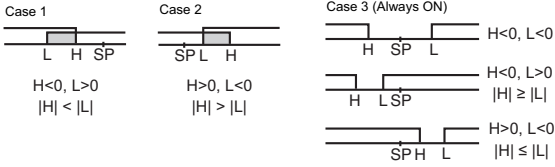

\*4. Set value: 5, Upper- and lower-limit with standby sequence For Upper- and Lower-Limit Alarm Described Above at \*2

- In cases 1 and 2 above, the alarm is always OFF if the upper- and lower-limit hysteresis overlaps.
- In case 3, the alarm is always OFF.

\*5. Set value: 5, Upper- and lower-limit alarm with standby sequence The alarm is always OFF if upper- and lower-limit hysteresis overlaps.

\*6. Refer to the *E5DC Digital Temperature Controllers User's Manual* (Cat. No. H174) for information on the operation of the standby sequence.

\*7. Refer to the *E5DC Digital Temperature Controllers User's Manual* (Cat. No. H174) for information on the LBA.

\*8. Refer to the *E5DC Digital Temperature Controllers User's Manual* (Cat. No. H174) for information on the PV change rate alarm.

\*9. When heating/cooling control is performed, the MV absolute-value upper-limit alarm functions only for the heating operation and the MV absolute-value lower-limit alarm functions only for the cooling operation.

## Characteristics

|   |  |   |
|---|--|---|
| <b>Indication accuracy (when mounted individually, ambient temperature of 23°C)</b> |  | Thermocouple: (±0.3 % of indication value or ±1°C, whichever is greater) ±1 digit max.*1<br>Platinum resistance thermometer: (±0.2 % of indication value or ±0.8°C, whichever is greater) ±1 digit max.<br>Analog input: ±0.2% FS ±1 digit max.<br>CT input: ±5% FS ±1 digit max. |
| <b>Simple transfer output accuracy</b>  |  | ±0.3% FS max.*2   |
| <b>Influence of temperature *3</b>  |  | Thermocouple input (R, S, B, W, PL II): (±1% of indication value or ±10°C, whichever is greater) ±1 digit max.  |
| <b>Influence of voltage *3</b>  |  | Other thermocouple input: (±1% of indication value or ±4°C, whichever is greater) ±1 digit max. *4<br>Platinum resistance thermometer: (±1% of indication value or ±2°C, whichever is greater) ±1 digit max.  |
| <b>Influence of EMS. (at EN 61326-1)</b>  |  | Analog input: ±1% FS ±1 digit max.<br>CT input: ±5% FS ±1 digit max.  |
| <b>Installation influence (E5DC only)</b>   |  | R, S, B, W, or PLII thermocouple: (±1% of PV or ±10°C, whichever is greater) ±1 digit max.<br>Other thermocouple: (±1% of PV or ±4°C, whichever is greater) ±1 digit max. *4  |
| <b>Input sampling period</b>  |  | 50 ms   |
| <b>Hysteresis</b>   |  | Temperature input: 0.1 to 999.9°C or °F (in units of 0.1°C or °F)<br>Analog input: 0.01% to 99.99% FS (in units of 0.01% FS)  |
| <b>Proportional band (P)</b>  |  | Temperature input: 0.1 to 999.9°C or °F (in units of 0.1°C or °F)<br>Analog input: 0.1% to 999.9% FS (in units of 0.1% FS)  |
| <b>Integral time (I)</b>  |  | 0 to 9999 s (in units of 1 s), 0.0 to 999.9 s (in units of 0.1 s) *5  |
| <b>Derivative time (D)</b>  |  | 0 to 9999 s (in units of 1 s), 0.0 to 999.9 s (in units of 0.1 s) *5  |
| <b>Proportional band (P) for cooling</b>  |  | Temperature input: 0.1 to 999.9°C or °F (in units of 0.1°C or °F)<br>Analog input: 0.1% to 999.9% FS (in units of 0.1% FS)  |
| <b>Integral time (I) for cooling</b>  |  | 0 to 9999 s (in units of 1 s), 0.0 to 999.9 s (in units of 0.1 s) *5  |
| <b>Derivative time (D) for cooling</b>  |  | 0 to 9999 s (in units of 1 s), 0.0 to 999.9 s (in units of 0.1 s) *5  |
| <b>Control period</b>   |  | 0.1, 0.2, 0.5, 1 to 99 s (in units of 1 s)  |
| <b>Manual reset value</b>   |  | 0.0% to 100.0% (in units of 0.1%)   |
| <b>Alarm setting range</b>  |  | -1,999 to 9,999 (decimal point position depends on input type)  |
| <b>Influence of signal source resistance</b>  |  | Thermocouple: 0.1°C/Ω max. (100 Ω max.), Platinum resistance thermometer: 0.1°C/Ω max. (10 Ω max.)  |
| <b>Insulation resistance</b>  |  | 20 MΩ min. (at 500 VDC)   |
| <b>Dielectric strength</b>  |  | 3,000 VAC, 50/60 Hz for 1 min between terminals of different charge   |
| <b>Vibration</b>  | <b>Malfunction</b>   | 10 to 55 Hz, 20 m/s <sup>2</sup> for 10 min each in X, Y and Z directions   |
|   | <b>Resistance</b>  | 10 to 55 Hz, 20 m/s <sup>2</sup> for 2 hr each in X, Y, and Z directions  |
| <b>Shock</b>  | <b>Malfunction</b>   | 100 m/s <sup>2</sup> , 3 times each in X, Y, and Z directions   |
|   | <b>Resistance</b>  | 300 m/s <sup>2</sup> , 3 times each in X, Y, and Z directions   |
| <b>Weight</b>   |  | Main unit: Approx. 80 g, Terminal unit: Approx. 40 g  |
| <b>Degree of protection</b>   |  | Main unit: IP20, Terminal unit: IP00  |
| <b>Memory protection</b>  |  | Non-volatile memory (number of writes: 1,000,000 times)   |
| <b>Setup Tool</b>   |  | CX-Thermo version 4.6 or higher   |
| <b>Setup Tool port</b>  |  | E5DC bottom panel: An E58-CIFQ2 USB-Serial Conversion Cable is used to connect a USB port on the computer. *6<br>E5DC front panel: An E58-CIFQ2 USB-Serial Conversion Cable and E58-CIFQ2-E Conversion Cable are used together to connect a USB port on the computer.*6           |
| <b>Standards</b>  | <b>Approved standards</b>  | cULus: UL 61010-1/CSA C22.2 No.61010-1, Korean wireless regulations (Radio law: KC Mark) (Some models only.) *7, Lloyd's standards *8   |
|   | <b>Conformed standards</b>   | EN 61010-1 (IEC 61010-1)  |
| <b>EMC</b>  | EMI:<br>Radiated Interference Electromagnetic Field Strength: EN61326-1 *9<br>Noise Terminal Voltage: EN55011 Group 1, class A<br>EMS:<br>ESD Immunity: EN61326-1 *9<br>Electromagnetic Field Immunity: EN61000-4-2<br>Burst Noise Immunity: EN61000-4-3<br>Conducted Disturbance Immunity: EN61000-4-4<br>Surge Immunity: EN61000-4-6<br>Voltage Dip/Interrupting Immunity: EN61000-4-5<br>EN61000-4-11 |   |

\*1. The indication accuracy of K thermocouples in the -200 to 1,300°C range, T and N thermocouples at a temperature of -100°C max., and U and L thermocouples at any temperature is ±2°C ±1 digit max. The indication accuracy of B thermocouples at a temperature of 400°C max. is not specified. The indication accuracy of B thermocouples at a temperature of 400 to 800°C is ±3°C max.

The indication accuracy of R and S thermocouples at a temperature of 200°C max. is ±3°C ±1 digit max. The indication accuracy of W thermocouples is (±0.3% of PV or ±3°C, whichever is greater) ±1 digit max.

The indication accuracy of PLII thermocouples is (±0.3% of PV or ±2°C, whichever is greater) ±1 digit max.

\*2. However, the precision between 0 and 4 mA for a 0 to 20 mA output is ±1% FS max.

\*3. Ambient temperature: -10°C to 23°C to 55°C, Voltage range: -15% to 10% of rated voltage

\*4. K thermocouple at -100°C max.: ±10°C max.

\*5. The unit is determined by the setting of the Integral/Derivative Time Unit parameter.

\*6. External serial communications (RS-485) and USB-Serial Conversion Cable communications can be used at the same time.

\*7. Refer to your OMRON website for the most recent information on applicable models.

\*8. Refer to information on maritime standards in *Shipping Standards* on page 110 for compliance with Lloyd's Standards.

\*9. Industrial electromagnetic environment (EN/IEC 61326-1 Table 2)

## USB-Serial Conversion Cable

|                               |  |
|-------------------------------|--|
| Applicable OS                 | Windows XP/Vista/7/8/10 *1   |
| Applicable software           | CX-Thermo version 4.6 or higher  |
| Applicable models             | E5□C-T Series, E5□C Series, and E5CB Series  |
| USB interface standard        | Conforms to USB Specification 2.0  |
| DTE speed                     | 38,400 bps   |
| Connector specifications      | Computer: USB (Type A plug)<br>Digital Temperature Controller: Special serial connector        |
| Power supply                  | Bus power (Supplied from the USB host controller) *2   |
| Power supply voltage          | 5 VDC  |
| Current consumption           | 450 mA max.  |
| Output voltage                | 4.7±0.2 VDC (Supplied from USB-Serial Conversion Cable to the Digital Temperature Controller.) |
| Output current                | 250 mA max. (Supplied from USB-Serial Conversion Cable to the Digital Temperature Controller.) |
| Ambient operating temperature | 0 to 55°C (with no condensation or icing)  |
| Ambient operating humidity    | 10% to 80%   |
| Storage temperature           | -20 to 60°C (with no condensation or icing)  |
| Storage humidity              | 10% to 80%   |
| Altitude                      | 2,000 m max.   |
| Weight                        | Approx. 120 g  |

Windows is a registered trademark of Microsoft Corporation in the United States and or other countries.

\*1. CX-Thermo version 4.65 or higher runs on Windows 10.

\*2. Use a high-power port for the USB port.

**Note:** A driver must be installed on the computer. Refer to the *Instruction Manual* included with the Cable for the installation procedure.

## Communications Specifications

|                                     |  |
|-------------------------------------|--|
| Transmission line connection method | RS-485: Multidrop  |
| Communications                      | RS-485 (two-wire, half duplex)   |
| Synchronization method              | Start-stop synchronization   |
| Protocol                            | CompoWay/F, or Modbus  |
| Baud rate *                         | 9,600, 19,200, 38,400, or 57,600 bps   |
| Transmission code                   | ASCII  |
| Data bit length *                   | 7 or 8 bits  |
| Stop bit length *                   | 1 or 2 bits  |
| Error detection                     | Vertical parity (none, even, odd)<br>Block check character (BCC) with CompoWay/F or CRC-16 with Modbus |
| Flow control                        | None   |
| Interface                           | RS-485   |
| Retry function                      | None   |
| Communications buffer               | 217 bytes  |
| Communications response wait time   | 0 to 99 ms<br>Default: 20 ms   |

\* The baud rate, data bit length, stop bit length, and vertical parity can be individually set using the Communications Setting Level.

## Communications Functions

|                               |   |
|-------------------------------|---|
| Programless communications *1 | You can use the memory in the PLC to read and write E5□C parameters, start and stop operation, etc. The E5□C automatically performs communications with PLCs. No communications programming is required. Number of connected Digital Temperature Controllers: 32 max. (Up to 16 for the FX Series)<br>Applicable PLCs: OMRON PLCs<br>CS Series, CJ Series, or CP Series<br>Mitsubishi Electric PLCs<br>MELSEC Q Series, L Series, or FX Series (compatible with the FX2 or FX3 (excluding the FX1S))<br>KEYENCE PLCs<br>KEYENCE KV Series |
|-------------------------------|---|

|                             |   |
|-----------------------------|---|
| Component Communications *1 | When Digital Temperature Controllers are connected, set points and RUN/STOP commands can be sent from the Digital Temperature Controller that is set as the master to the Digital Temperature Controllers that are set as slaves. Slope and offsets can be set for the set point. Number of connected Digital Temperature Controllers: 32 max. (including master) |
| Copying *2                  | When Digital Temperature Controllers are connected, the parameters can be copied from the Digital Temperature Controller that is set as the master to the Digital Temperature Controllers that are set as slaves.   |

MELSEC is a registered trademark of Mitsubishi Electric Corporation. KEYENCE is a registered trademark of Keyence Corporation.

\*1. A Temperature Controller with version 2.1 or higher is required for the FX Series or the KV Series.

\*2. Both the programless communications and the component communications support the copying.

## Current Transformer (Order Separately) Ratings

|                            |   |
|----------------------------|---|
| Dielectric strength        | 1,000 VAC for 1 min                               |
| Vibration resistance       | 50 Hz, 98 m/s <sup>2</sup>                        |
| Weight                     | E54-CT1: Approx. 11.5 g,<br>E54-CT3: Approx. 50 g |
| Accessories (E54-CT3 only) | Armatures (2)<br>Plugs (2)                        |

## Heater Burnout Alarms and SSR Failure Alarms

|   |  |
|---|--|
| CT input (for heater current detection) | Models with detection for single-phase heaters: One input                  |
| Maximum heater current                  | 50 A AC  |
| Input current indication accuracy       | ±5% FS ±1 digit max.   |
| Heater burnout alarm setting range *1   | 0.1 to 49.9 A (in units of 0.1 A)<br>Minimum detection ON time: 100 ms *3  |
| SSR failure alarm setting range *2      | 0.1 to 49.9 A (in units of 0.1 A)<br>Minimum detection OFF time: 100 ms *4 |

\*1. For heater burnout alarms, the heater current will be measured when the control output is ON, and the output will turn ON if the heater current is lower than the set value (i.e., heater burnout detection current value).

\*2. For SSR failure alarms, the heater current will be measured when the control output is OFF, and the output will turn ON if the heater current is higher than the set value (i.e., SSR failure detection current value).

\*3. The value is 30 ms for a control period of 0.1 s or 0.2 s.

\*4. The value is 35 ms for a control period of 0.1 s or 0.2 s.

## Electrical Life Expectancy Curve for Control Output Relay (Reference Values)

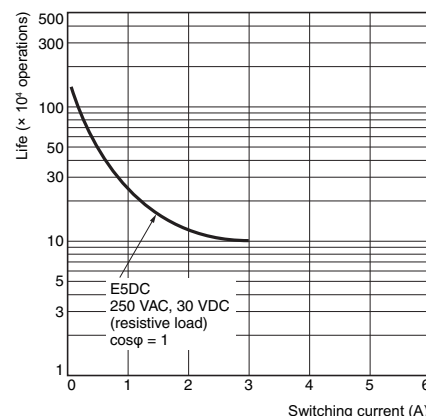

# External Connections

## E5DC

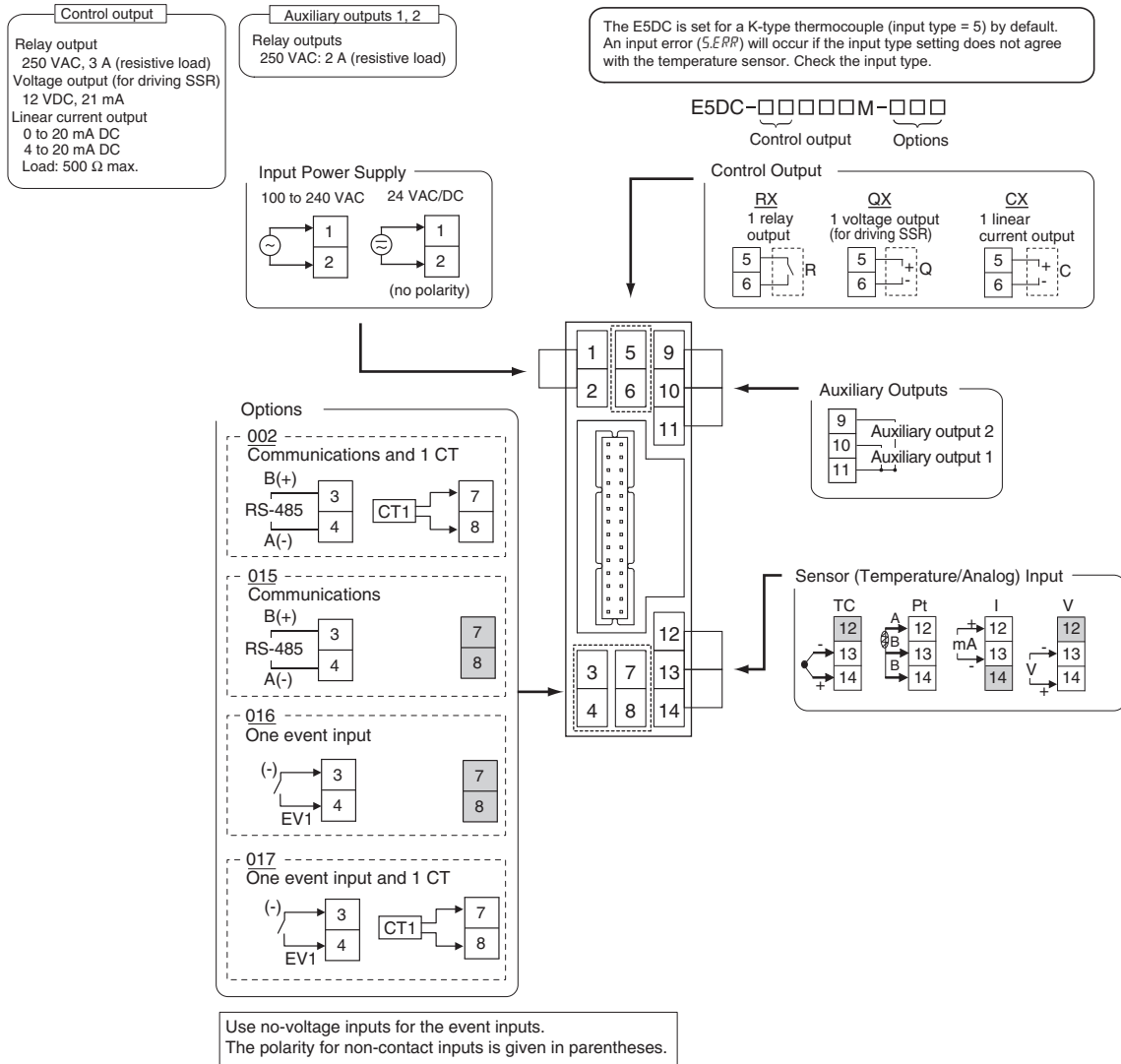

- Note:**
1. The application of the terminals depends on the model.
  2. Do not wire the terminals that are shown with a gray background.
  3. When complying with EMC standards, the cable that connects the sensor must be 30 m or less. If the cable length exceeds 30m, compliance with EMC standards will not be possible.
  4. Connect M3 crimped terminals.

## Isolation/Insulation Block Diagrams

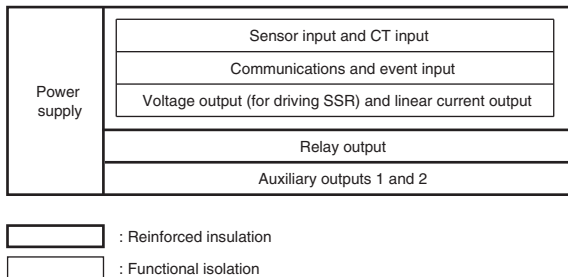

**Note:** Auxiliary outputs 1 to 2 are not insulated.

# E5DC

## Nomenclature

### E5DC

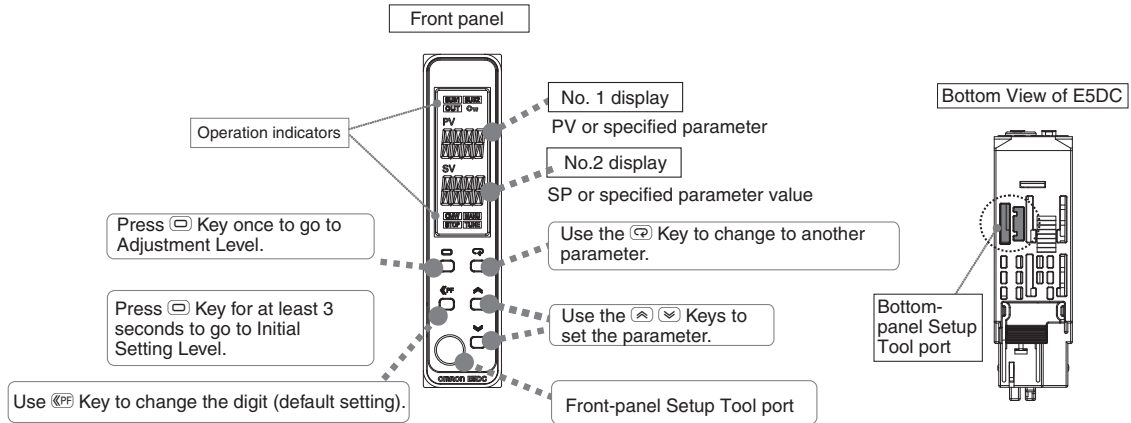

## Dimensions

(Unit: mm)

### Controllers

#### E5DC

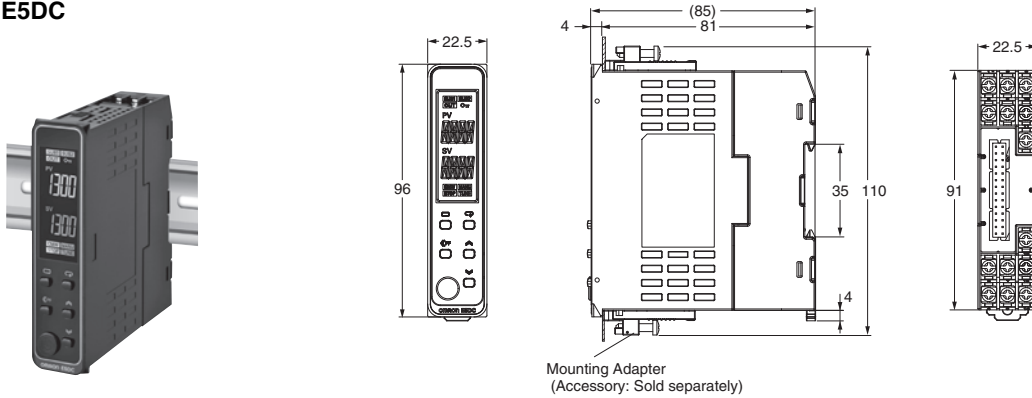

The above figure shows the Terminal Unit attached to the Main Unit.

- Setup Tool ports are provided as standard feature. Use these ports to connect a computer to the Digital Temperature Controller. The E58-CIFQ2 USB-Serial Conversion Cable is required to connect to the port on the bottom panel. The E58-CIFQ2 USB-Serial Conversion Cable and E58-CIFQ2-E Communications Conversion Cable are required to connect to the port on the front panel. (You cannot leave either port connected constantly during operation.)

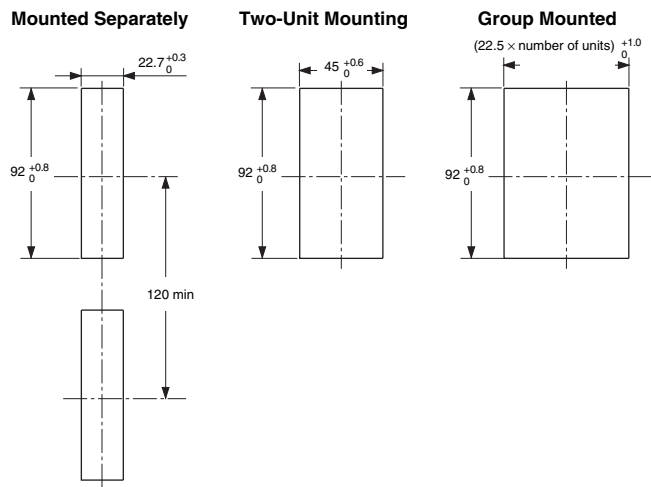

- Recommended panel thickness is 1 to 8 mm.
- Group mounting is not possible in the vertical direction. (Maintain the specified mounting space between Controllers.)
- When two or more Digital Temperature Controllers are mounted, make sure that the surrounding temperature does not exceed the allowable operating temperature specified in the specifications.



Accessories (Order Separately)

Terminal Unit  
E5DC-SCT1S



USB-Serial Conversion Cable  
E58-CIFQ2

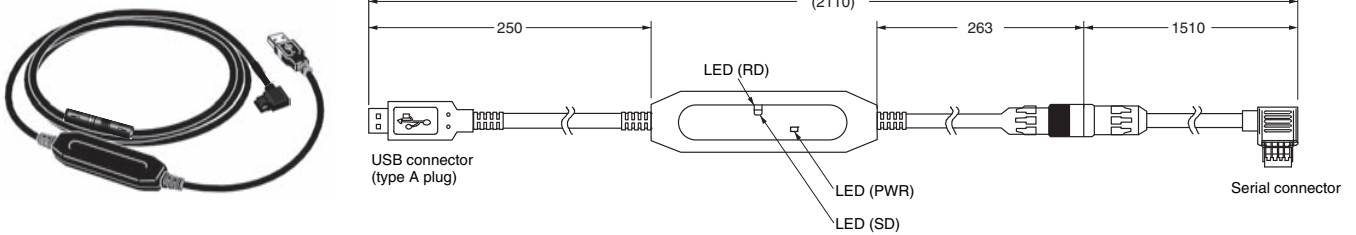

Conversion Cable  
E58-CIFQ2-E

Conversion Cable

Connecting to the E58-CIFQ2 USB-Serial Conversion Cable

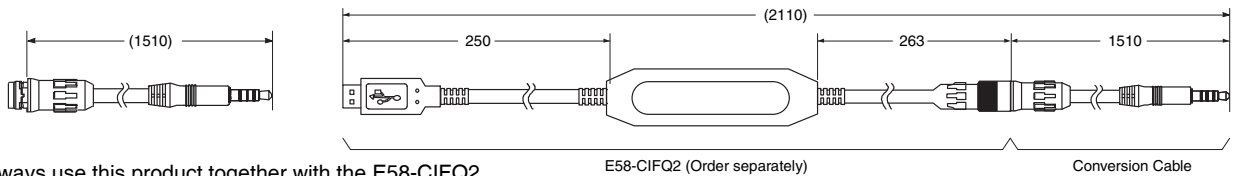

**Note:** Always use this product together with the E58-CIFQ2.

## ● Current Transformers

### E54-CT1

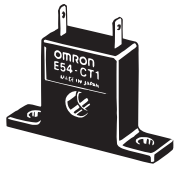

### E54-CT3

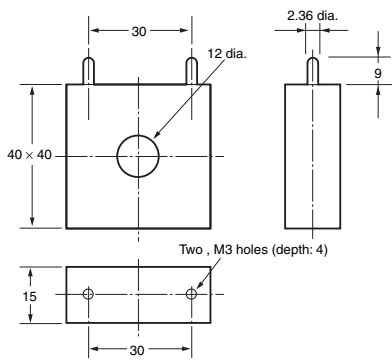

### E54-CT3 Accessories

#### ● Armature

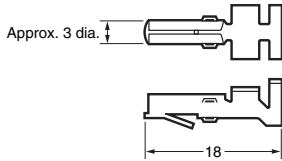

#### ● Plug

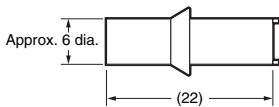

#### Connection Example

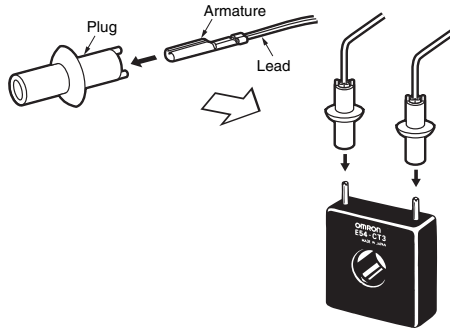

### Thru-current ( $I_o$ ) vs. Output Voltage ( $E_o$ ) (Reference Values)

#### E54-CT1

Maximum continuous heater current: 50 A (50/60 Hz)  
 Number of windings: 400±2  
 Winding resistance: 18±2 Ω

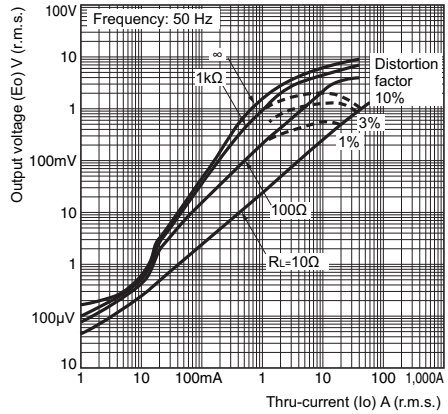

### Thru-current ( $I_o$ ) vs. Output Voltage ( $E_o$ ) (Reference Values)

#### E54-CT3

Maximum continuous heater current: 120 A (50/60 Hz)  
 (Maximum continuous heater current for an OMRON Digital Temperature Controller is 50 A.)  
 Number of windings: 400±2  
 Winding resistance: 8±0.8 Ω

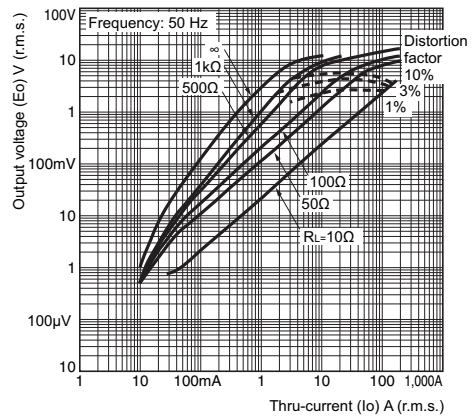

**Mounting Adapters**

**Y92F-53 (Two included.)**

This accessory is not included with the product. Order it separately to mount the product to a panel.

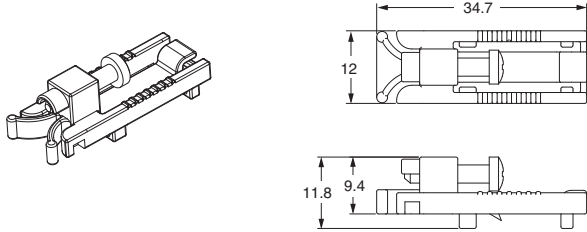

**Short Bars**

**Y92S-P11 (Four included.)**

Use this product to connect between terminals (for power supplies, communications, etc.) when you use multiple E5DC Controllers.

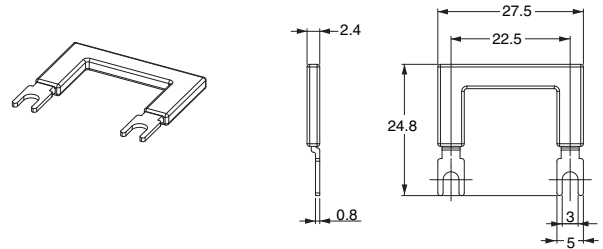

**End Plate**

**PFP-M**

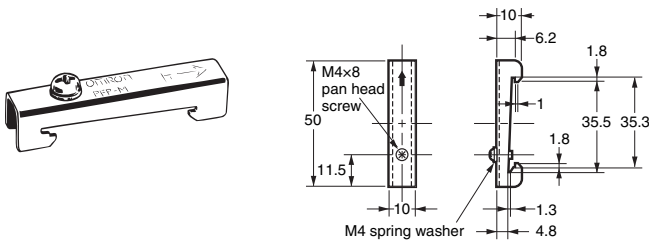

**DIN Tracks**

**PFP-100N  
PFP-50N**

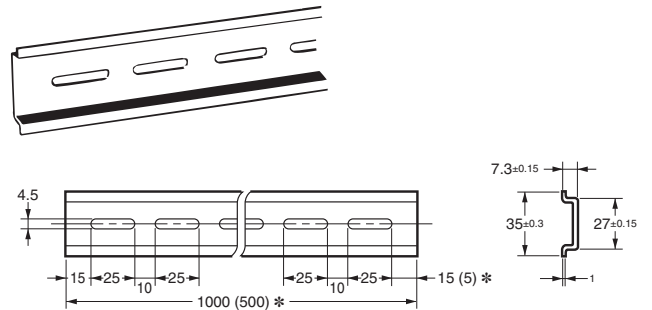

\* Dimensions in parentheses are for the PFP-50N.

**Spacer**

**PFP-S**

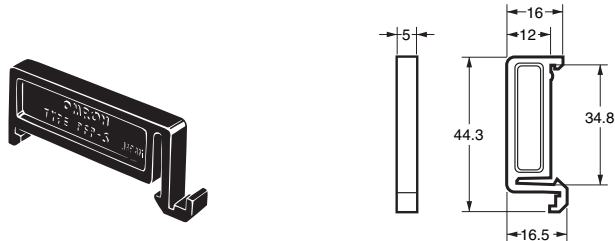

**Unit Labels**

**Y92S-L2**

|       |       |                |    |     |    |                  |
|-------|-------|----------------|----|-----|----|------------------|
| V     | A     | V <sub>A</sub> | %  | J   | Pa | Ω                |
| s     | /     | N              | m  | W   | °C | m <sup>3</sup> k |
| °F    | g     | min            | mm | rpm |    |                  |
| VA    | mV    | mA             | Hz |     |    |                  |
| m/min | OMRON |                |    |     |    |                  |
| OUT   | OUT   |                |    |     |    |                  |

The Unit Labels for the Digital Panel Meter are used. Use either the °C or °F label from the sheet.

**End Cover**

**Y92F-54 (Two included.)**

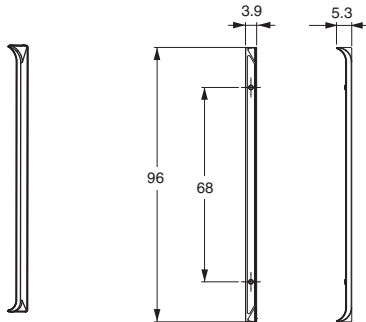

Use the End Cover when you mount the E5DC to a panel to hide the gap between the Controller and the panel.

# Programmable Temperature Controller (Digital Controller)

# E5CC-T (48 × 48 mm)

**Programmable Controllers Join the E5□C Series!**  
**Program up to 256 segments can handle a wide variety of applications.**

- Set up to 8 Programs (Patterns) with 32 Segments (Steps) Each
- The white PV display with a height of 15.2 mm improves visibility.
- High-speed sampling at 50 ms.
- Models are available with up to 3 auxiliary outputs, up to 4 event inputs, and a transfer output to cover a wide range of applications.
- Short body with depth of only 60 mm.
- Set up the Controller without wiring the power supply by connecting to the computer with a Communications Conversion Cable (sold separately). Setup is easy with the CX-Thermo (sold separately).
- Easy connections to a PLC with programless communications. Use component communications to link Temperature Controllers to each other.



48 × 48 mm  
E5CC-T

Refer to your OMRON website for the most recent information on applicable safety standards.

Refer to Safety Precautions on page 108.

## Main I/O Functions

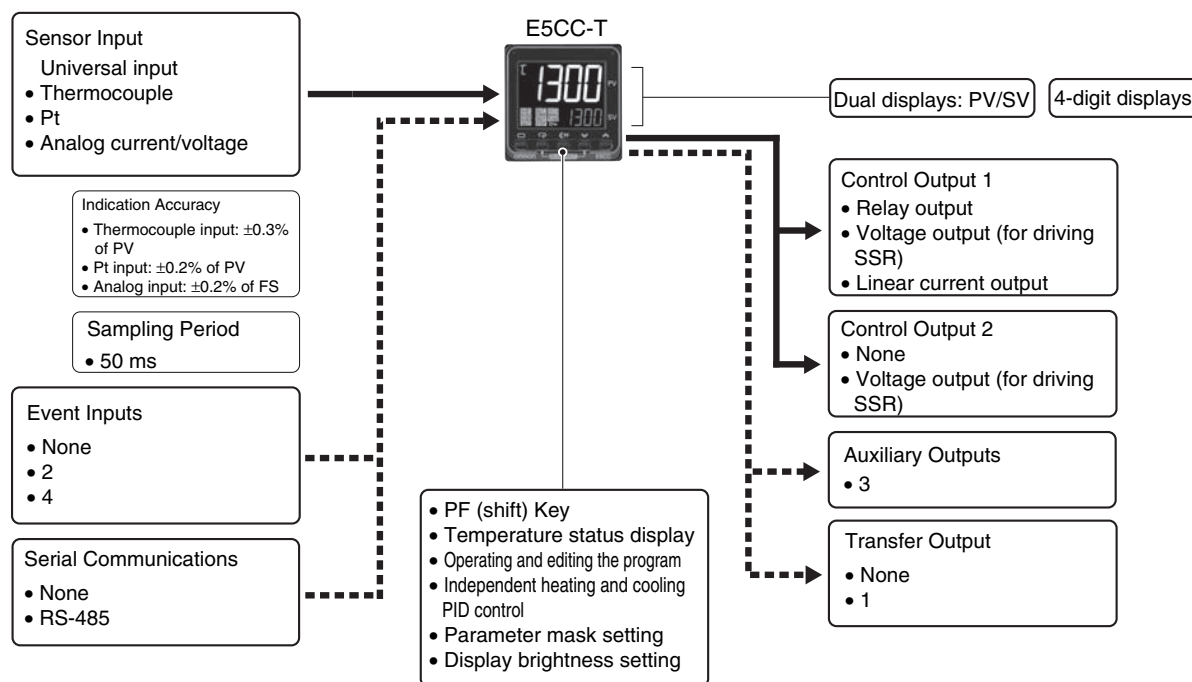

This datasheet is provided as a guideline for selecting products.

Be sure to refer to the following manuals for application precautions and other information required for operation before attempting to use the product.

E5□C-T Digital Temperature Controllers Programmable Type User's Manual (Cat. No. H185)

E5□C-T Digital Temperature Controllers Programmable Type Communications Manual (Cat. No. H186)

## Model Number Legend and Standard Models

### Model Number Legend

Models with Screw Terminal Blocks

E5CC-T □□3 □5 M -□□□ (Example: E5CC-TRX3A5M-000)

① ②③④⑤ ⑥

| Model  | A                       | B                        | C                    | D             | E          | F       | Meaning                            |                         |                                  |              |                 |
|--------|-------------------------|--------------------------|----------------------|---------------|------------|---------|------------------------------------|-------------------------|----------------------------------|--------------|-----------------|
|        | Control outputs 1 and 2 | No. of auxiliary outputs | Power supply voltage | Terminal type | Input type | Options |                                    |                         |                                  |              |                 |
| E5CC-T |                         |                          |                      |               |            |         | 48 × 48 mm Programmable Type       |                         |                                  |              |                 |
|        |                         |                          |                      |               |            |         | Control output 1                   |                         | Control output 2                 |              |                 |
|        | RX                      |                          |                      |               |            |         | Relay output                       |                         | None                             |              |                 |
|        | QX                      |                          |                      |               |            |         | Voltage output (for driving SSR)   |                         | None                             |              |                 |
| *1     | CX                      |                          |                      |               |            |         | Linear current output *2           |                         | None                             |              |                 |
|        | QQ                      |                          |                      |               |            |         | Voltage output (for driving SSR)   |                         | Voltage output (for driving SSR) |              |                 |
|        | CQ                      |                          |                      |               |            |         | Linear current output *2           |                         | Voltage output (for driving SSR) |              |                 |
|        |                         | 3                        |                      |               |            |         | 3 (one common)                     |                         |                                  |              |                 |
|        |                         |                          | A                    |               |            |         | 100 to 240 VAC                     |                         |                                  |              |                 |
|        |                         |                          | D                    |               |            |         | 24 VAC/DC                          |                         |                                  |              |                 |
|        |                         |                          |                      | 5             |            |         | Screw terminal blocks (with cover) |                         |                                  |              |                 |
|        |                         |                          |                      |               | M          |         | Universal input                    |                         |                                  |              |                 |
|        |                         |                          |                      |               |            |         |                                    | HB alarm and HS alarm   | Communications                   | Event inputs | Transfer output |
|        |                         |                          |                      |               |            |         | 000                                | ---                     | ---                              | ---          | ---             |
|        |                         |                          |                      |               |            | *1      | 001                                | 1                       | ---                              | 2            | ---             |
|        |                         |                          |                      |               |            | *1      | 003                                | 2 (for 3-phase heaters) | RS-485                           | ---          | ---             |
|        |                         |                          |                      |               |            | *3      | 004                                | ---                     | RS-485                           | 2            | ---             |
|        |                         |                          |                      |               |            |         | 005                                | ---                     | ---                              | 4            | ---             |
|        |                         |                          |                      |               |            |         | 006                                | ---                     | ---                              | 2            | Provided.       |

\*1. Options with HB and HS alarms (001 and 003) cannot be selected if a linear current output is selected for the control output.

\*2. The linear current output cannot be used as a transfer output.

\*3. Option 004 can be selected only when "CX" is selected for the control outputs.

## Heating and Cooling Control

### Using Heating and Cooling Control

#### ① Control Output Assignment

If there is no control output 2, an auxiliary output is used as the cooling control output.

If there is a control output 2, the two control outputs are used for heating and cooling.

(It does not matter which output is used for heating and which output is used for cooling.)

#### ② Control

If PID control is used, you can set PID control separately for heating and cooling.

This allows you to handle control systems with different heating and cooling response characteristics.

## Optional Products (Order Separately)

### USB-Serial Conversion Cable

| Model     |
|-----------|
| E58-CIFQ2 |

### Terminal Covers

| Model            |
|------------------|
| E53-COV17        |
| E53-COV23 (3pcs) |

**Note:** The Terminal Covers E53-COV23 are provided with the Digital Temperature Controller. The E53-COV10 cannot be used. Refer to page 79 for the mounted dimensions.

### Waterproof Packing

| Model   |
|---------|
| Y92S-P8 |

**Note:** The Waterproof Packing is provided with the Digital Temperature Controller.

### Current Transformers (CTs)

| Hole diameter | Model   |
|---------------|---------|
| 5.8 mm        | E54-CT1 |
| 12.0 mm       | E54-CT3 |

### Adapter

| Model   |
|---------|
| Y92F-45 |

**Note:** Use this Adapter when the panel has already been prepared for an E5B□ Controller.

### Waterproof Cover

| Model    |
|----------|
| Y92A-48N |

### Mounting Adapter

| Model   |
|---------|
| Y92F-49 |

**Note:** This Mounting Adapter is provided with the Digital Temperature Controller.

### DIN Track Mounting Adapter

| Model   |
|---------|
| Y92F-52 |

### Front Covers

| Type             | Model    |
|------------------|----------|
| Hard Front Cover | Y92A-48H |
| Soft Front Cover | Y92A-48D |

### CX-Thermo Support Software

| Model       |
|-------------|
| EST2-2C-MV4 |

**Note:** CX-Thermo version 4.61 or higher is required for the E5CC-T. For the system requirements for the CX-Thermo, refer to information on the EST2-2C-MV4 on the OMRON website ([www.ia.omron.com](http://www.ia.omron.com)).

## Specifications

### Ratings

|                                      |   |   |
|--------------------------------------|---|---|
| <b>Power supply voltage</b>          | A in model number: 100 to 240 VAC, 50/60 Hz<br>D in model number: 24 VAC, 50/60 Hz; 24 VDC  |   |
| <b>Operating voltage range</b>       | 85 to 110% of rated supply voltage  |   |
| <b>Power consumption</b>             | 7.5 VA max. at 100 to 240 VAC, and 4.1 VA max. at 24 VAC or 2.3 W max. at 24 VDC  |   |
| <b>Sensor input</b>                  | Temperature input<br>Thermocouple: K, J, T, E, L, U, N, R, S, B, W, or PL II<br>Platinum resistance thermometer: Pt100 or JPt100<br>Infrared temperature sensor (ES1B): 10 to 70°C, 60 to 120°C, 115 to 165°C, or 140 to 260°C<br>Analog input<br>Current input: 4 to 20 mA or 0 to 20 mA<br>Voltage input: 1 to 5 V, 0 to 5 V, or 0 to 10 V  |   |
| <b>Input impedance</b>               | Current input: 150 Ω max., Voltage input: 1 MΩ min.<br>(Use a 1:1 connection when connecting the ES2-HB/THB.)   |   |
| <b>Control method</b>                | 2-PID control (with auto-tuning) or ON/OFF control  |   |
| <b>Control output</b>                | <b>Relay output</b>   | SPST-NO, 250 VAC, 3 A (resistive load), electrical life: 100,000 operations, minimum applicable load: 5 V, 10 mA (reference value)  |
|                                      | <b>Voltage output (for driving SSR)</b>   | Output voltage: 12 VDC ±20% (PNP), max. load current: 21 mA, with short-circuit protection circuit  |
|                                      | <b>Linear current output</b>  | 4 to 20 mA DC/0 to 20 mA DC, load: 500 Ω max., resolution: approx. 10,000   |
| <b>Auxiliary output</b>              | <b>Number of outputs</b>  | 3   |
|                                      | <b>Output specifications</b>  | SPST-NO relay outputs, 250 VAC, Models with 3 outputs: 2 A (resistive load), Electrical life: 100,000 operations, Minimum applicable load: 10 mA at 5 V (reference value) |
| <b>Event input</b>                   | <b>Number of inputs</b>   | 2 or 4 (depends on model)   |
|                                      | <b>External contact input specifications</b>  | Contact input: ON: 1 kΩ max., OFF: 100 kΩ min.  |
|                                      |   | Non-contact input: ON: Residual voltage: 1.5 V max., OFF: Leakage current: 0.1 mA max.<br>Current flow: Approx. 7 mA per contact  |
| <b>Transfer output</b>               | <b>Number of outputs</b>  | 1 (only on models with a transfer output)   |
|                                      | <b>Output specifications</b>  | Current output: 4 to 20 mA DC, load: 500 Ω max., resolution: approx. 10,000<br>Linear voltage output: 1 to 5 VDC, load: 1 kΩ min., resolution: Approx. 10,000             |
| <b>Setting method</b>                | Digital setting using front panel keys  |   |
| <b>Indication method</b>             | 11-segment digital display and individual indicators<br>Character height: PV: 15.2 mm, SV: 7.1 mm   |   |
| <b>Bank switching</b>                | None  |   |
| <b>Other functions</b>               | Manual output, heating/cooling control, loop burnout alarm, other alarm functions, heater burnout (HB) alarm (including SSR failure (HS) alarm), 40% AT, 100% AT, MV limiter, input digital filter, robust tuning, PV input shift, protection functions, extraction of square root, MV change rate limit, logic operations, temperature status display, moving average of input value, and display brightness setting |   |
| <b>Ambient operating temperature</b> | -10 to 55°C (with no condensation or icing), For 3-year warranty: -10 to 50°C with standard mounting (with no condensation or icing)  |   |
| <b>Ambient operating humidity</b>    | 25 to 85%   |   |
| <b>Storage temperature</b>           | -25 to 65°C (with no condensation or icing)   |   |
| <b>Altitude</b>                      | 2,000 m max.  |   |
| <b>Recommended fuse</b>              | T2A, 250 VAC, time-lag, low-breaking capacity   |   |
| <b>Installation environment</b>      | Overvoltage category II, Pollution Degree 2 (EN/IEC/UL 61010-1)   |   |

## Input Ranges

### Thermocouple/Platinum Resistance Thermometer (Universal inputs)

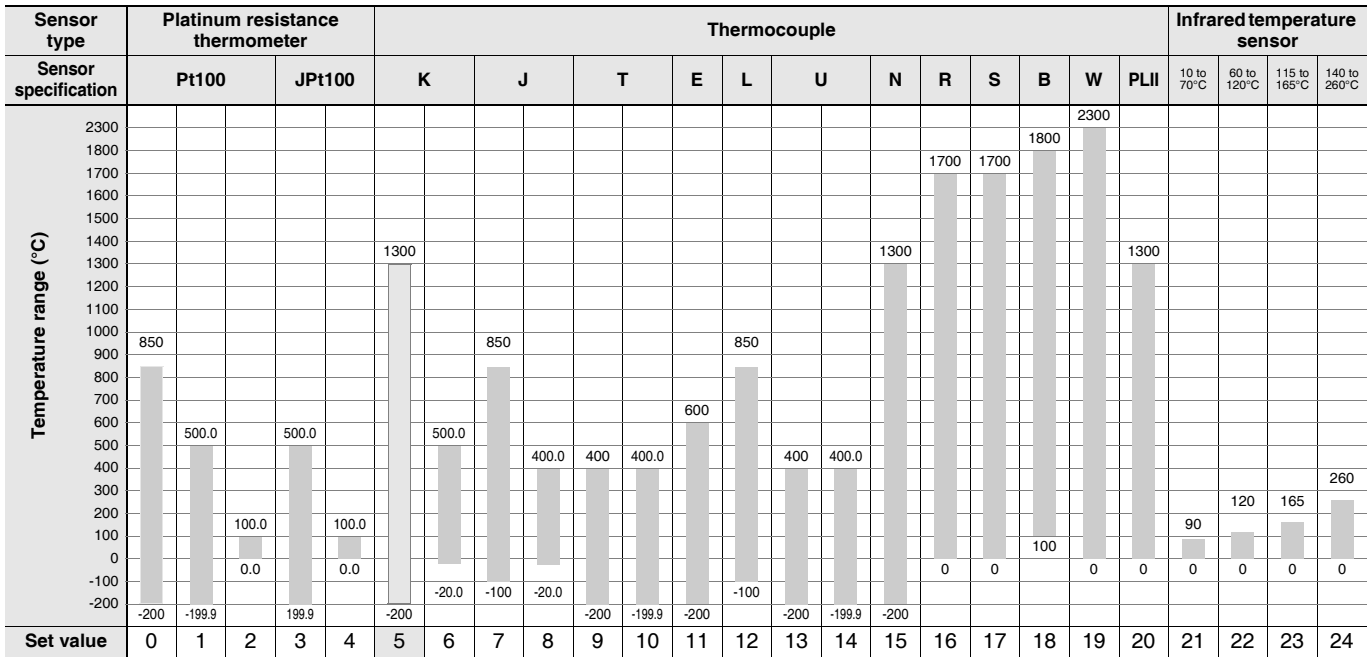

Shaded settings are the default settings.

The applicable standards for the input types are as follows:

K, J, T, E, N, R, S, B: JIS C 1602-1995, IEC 60584-1

JPt100: JIS C 1604-1989, JIS C 1606-1989

L: Fe-CuNi, DIN 43710-1985

Pt100: JIS C 1604-1997, IEC 60751

U: Cu-CuNi, DIN 43710-1985

PL II: According to Platinel II electromotive force charts from BASF (previously Engelhard)

W: W5Re/W26Re, ASTM E988-1990

### Analog input

| Input type          | Current   |            | Voltage  |          |           |
|---------------------|---|------------|----------|----------|-----------|
| Input specification | 4 to 20 mA  | 0 to 20 mA | 1 to 5 V | 0 to 5 V | 0 to 10 V |
| Setting range       | Usable in the following ranges by scaling:<br>-1999 to 9999, -199.9 to 999.9,<br>-19.99 to 99.99 or -1.999 to 9.999 |            |          |          |           |
| Set value           | 25  | 26         | 27       | 28       | 29        |



## Alarm Types

Each alarm can be independently set to one of the following 17 alarm types. The default is 2: Upper limit. (see note.)

Auxiliary outputs are allocated for alarms. ON delays and OFF delays (0 to 999 s) can also be specified.

**Note:** In the default settings for models with HB or HS alarms, alarm 1 is set to a heater alarm (HA) and the Alarm Type 1 parameter is not displayed. To use alarm 1, set the output assignment to alarm 1.

| Set value   | Alarm type                                       | Alarm output operation                   |   | Description of function  |
|-------------|--|--|---|--|
|             |  | When alarm value X is positive           | When alarm value X is negative                    |  |
| 0           | Alarm function OFF                               | Output OFF                               |   | No alarm   |
| 1           | Upper- and lower-limit *1                        |  | *2  | Set the upward deviation in the set point for the alarm upper limit (H) and the lower deviation in the set point for the alarm lower limit (L). The alarm is ON when the PV is outside this deviation range. |
| 2 (default) | Upper-limit                                      |  |   | Set the upward deviation in the set point by setting the alarm value (X). The alarm is ON when the PV is higher than the SP by the deviation or more.  |
| 3           | Lower-limit                                      |  |   | Set the downward deviation in the set point by setting the alarm value (X). The alarm is ON when the PV is lower than the SP by the deviation or more.   |
| 4           | Upper- and lower-limit range *1                  |  | *3  | Set the upward deviation in the set point for the alarm upper limit (H) and the lower deviation in the set point for the alarm lower limit (L). The alarm is ON when the PV is inside this deviation range.  |
| 5           | Upper- and lower-limit with standby sequence *1  | *5                                       | *4  | A standby sequence is added to the upper- and lower-limit alarm (1). *6  |
| 6           | Upper-limit with standby sequence                |  |   | A standby sequence is added to the upper-limit alarm (2). *6   |
| 7           | Lower-limit with standby sequence                |  |   | A standby sequence is added to the lower-limit alarm (3). *6   |
| 8           | Absolute-value upper-limit                       |  |   | The alarm will turn ON if the process value is larger than the alarm value (X) regardless of the set point.  |
| 9           | Absolute-value lower-limit                       |  |   | The alarm will turn ON if the process value is smaller than the alarm value (X) regardless of the set point.   |
| 10          | Absolute-value upper-limit with standby sequence |  |   | A standby sequence is added to the absolute-value upper-limit alarm (8). *6  |
| 11          | Absolute-value lower-limit with standby sequence |  |   | A standby sequence is added to the absolute-value lower-limit alarm (9). *6  |
| 12          | LBA (alarm 1 type only)                          | -  |   | *7   |
| 13          | PV change rate alarm                             | -  |   | *8   |
| 14          | SP absolute-value upper-limit alarm              |  |   | This alarm type turns ON the alarm when the set point (SP) is higher than the alarm value (X).   |
| 15          | SP absolute-value lower-limit alarm              |  |   | This alarm type turns ON the alarm when the set point (SP) is lower than the alarm value (X).  |
| 16          | MV absolute-value upper-limit alarm *9           | Standard Control<br>                     | Standard Control<br>                              | This alarm type turns ON the alarm when the manipulated variable (MV) is higher than the alarm value (X).  |
|             |  | Heating/Cooling Control (Heating MV)<br> | Heating/Cooling Control (Heating MV)<br>Always ON |  |
| 17          | MV absolute-value lower-limit alarm *9           | Standard Control<br>                     | Standard Control<br>                              | This alarm type turns ON the alarm when the manipulated variable (MV) is lower than the alarm value (X).   |
|             |  | Heating/Cooling Control (Cooling MV)<br> | Heating/Cooling Control (Cooling MV)<br>Always ON |  |

**\*1.** With set values 1, 4 and 5, the upper and lower limit values can be set independently for each alarm type, and are expressed as "L" and "H."

**\*2.** Set value: 1, Upper- and lower-limit alarm

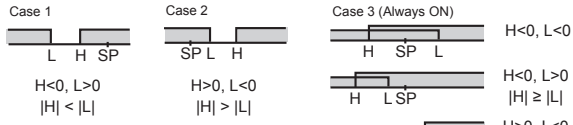

**\*3.** Set value: 4, Upper- and lower-limit range

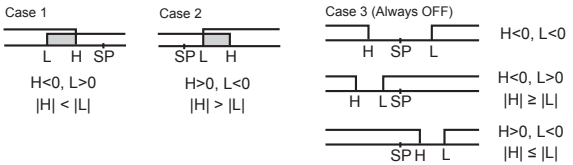

**\*4.** Set value: 5, Upper- and lower-limit with standby sequence For Upper- and Lower-Limit Alarm Described Above \*2

- Case 1 and 2
- Always OFF when the upper-limit and lower-limit hysteresis overlaps.
- Case 3: Always OFF

**\*5.** Set value: 5, Upper- and lower-limit with standby sequence Always OFF when the upper-limit and lower-limit hysteresis overlaps.

**\*6.** Refer to the *E5CC-T Digital Temperature Controllers Programmable Type User's Manual* (Cat. No. H185) for information on the operation of the standby sequence.

**\*7.** Refer to the *E5CC-T Digital Temperature Controllers Programmable Type User's Manual* (Cat. No. H185) for information on the loop burnout alarm (LBA).

**\*8.** Refer to the *E5CC-T Digital Temperature Controllers Programmable Type User's Manual* (Cat. No. H185) for information on the PV change rate alarm.

**\*9.** When heating/cooling control is performed, the MV absolute upper limit alarm functions only for the heating operation and the MV absolute lower limit alarm functions only for the cooling operation.

## Characteristics

|   |  |   |
|---|--|---|
| <b>Indication accuracy<br/>(at the ambient temperature of 23°C)</b> | Thermocouple: (±0.3% of indication value or ±1°C, whichever is greater) ±1 digit max. *1<br>Platinum resistance thermometer: (±0.2% of indication value or ±0.8°C, whichever is greater) ±1 digit max.<br>Analog input: ±0.2% FS ±1 digit max.<br>CT input: ±5% FS ±1 digit max. |   |
| <b>Transfer output accuracy</b>                                     | ±0.3% FS max.  |   |
| <b>Influence of temperature *2</b>                                  | Thermocouple input (R, S, B, W, PL II): (±1% of indication value or ±10°C, whichever is greater) ±1 digit max.   |   |
| <b>Influence of voltage *2</b>                                      | Other thermocouple input: (±1% of indication value or ±4°C, whichever is greater) ±1 digit max. *3<br>Platinum resistance thermometer: (±1% of indication value or ±2°C, whichever is greater) ±1 digit max.   |   |
| <b>Influence of EMS.<br/>(at EN 61326-1)</b>                        | Analog input: ±1%FS ±1 digit max.<br>CT input: ±5% FS ±1 digit max.  |   |
| <b>Input sampling period</b>  | 50 ms  |   |
| <b>Hysteresis</b>   | Temperature input: 0.1 to 999.9°C or °F (in units of 0.1°C or °F)<br>Analog input: 0.01% to 99.99% FS (in units of 0.01% FS)   |   |
| <b>Proportional band (P)</b>  | Temperature input: 0.1 to 999.9°C or °F (in units of 0.1°C or °F)<br>Analog input: 0.1% to 999.9% FS (in units of 0.1% FS)   |   |
| <b>Integral time (I)</b>  | 0 to 9999 s (in units of 1 s), 0.0 to 999.9 s (in units of 0.1 s) *4   |   |
| <b>Derivative time (D)</b>  | 0 to 9999 s (in units of 1 s), 0.0 to 999.9 s (in units of 0.1 s) *4   |   |
| <b>Proportional band (P) for cooling</b>                            | Temperature input: 0.1 to 999.9°C or °F (in units of 0.1°C or °F)<br>Analog input: 0.1% to 999.9% FS (in units of 0.1% FS)   |   |
| <b>Integral time (I) for cooling</b>                                | 0 to 9999 s (in units of 1 s), 0.0 to 999.9 s (in units of 0.1 s) *4   |   |
| <b>Derivative time (D) for cooling</b>                              | 0 to 9999 s (in units of 1 s), 0.0 to 999.9 s (in units of 0.1 s) *4   |   |
| <b>Control period</b>   | 0.1, 0.2, 0.5, 1 to 99 s (in units of 1 s)   |   |
| <b>Manual reset value</b>   | 0.0 to 100.0% (in units of 0.1%)   |   |
| <b>Alarm setting range</b>  | -1999 to 9999 (decimal point position depends on input type)   |   |
| <b>Influence of signal source resistance</b>                        | Thermocouple: 0.1°C/Ω max. (100 Ω max.)<br>Platinum resistance thermometer: 0.1°C/Ω max. (10 Ω max.)   |   |
| <b>Insulation resistance</b>  | 20 MΩ min. (at 500 VDC)  |   |
| <b>Dielectric strength</b>  | 3,000 VAC, 50/60 Hz for 1 min between terminals of different charge  |   |
| <b>Vibration</b>  | <b>Malfunction</b>   | 10 to 55 Hz, 20 m/s <sup>2</sup> for 10 min each in X, Y, and Z directions  |
|   | <b>Resistance</b>  | 10 to 55 Hz, 20 m/s <sup>2</sup> for 2 hrs each in X, Y, and Z directions   |
| <b>Shock</b>  | <b>Malfunction</b>   | 100 m/s <sup>2</sup> , 3 times each in X, Y, and Z directions   |
|   | <b>Resistance</b>  | 300 m/s <sup>2</sup> , 3 times each in X, Y, and Z directions   |
| <b>Weight</b>   | Controller: Approx. 120 g, Adapter: Approx. 10 g   |   |
| <b>Degree of protection</b>   | Front panel: IP66, Rear case: IP20, Terminals: IP00  |   |
| <b>Memory protection</b>  | Non-volatile memory (number of writes: 1,000,000 times)  |   |
| <b>Setup Tool</b>   | CX-Thermo version 4.61 or higher   |   |
| <b>Setup Tool port</b>  | E5CC-T top panel: An E58-CIFQ2 USB-Serial Conversion Cable is used to connect to a USB port on the computer. *5  |   |
| <b>Standards</b>  | <b>Approved standards</b>  | cULus: UL 61010-1/CSA C22.2 No.61010-1, Korean wireless regulations (Radio law: KC Mark) (Some models only.) *6   |
|   | <b>Conformed standards</b>   | EN 61010-1 (IEC 61010-1)  |
| <b>EMC</b>  | EMI:<br>Radiated Interference Electromagnetic Field Strength:<br>Noise Terminal Voltage:<br>EMS:<br>ESD Immunity:<br>Electromagnetic Field Immunity:<br>Burst Noise Immunity:<br>Conducted Disturbance Immunity:<br>Surge Immunity:<br>Voltage Dip/Interrupting Immunity:        | EN 61326-1 *7<br>EN 55011 Group 1, class A<br>EN 55011 Group 1, class A<br>EN 61326-1 *7<br>EN 61000-4-2<br>EN 61000-4-3<br>EN 61000-4-4<br>EN 61000-4-4<br>EN 61000-4-6<br>EN 61000-4-5<br>EN 61000-4-11 |

\*1. The indication accuracy of K thermocouples in the -200 to 1300°C range, T and N thermocouples at a temperature of -100°C max., and U and L thermocouples at any temperatures is ±2°C ±1 digit max. The indication accuracy of the B thermocouple at a temperature of 400°C max. is not specified. The indication accuracy of B thermocouples at a temperature of 400 to 800°C is ±3°C max. The indication accuracy of the R and S thermocouples at a temperature of 200°C max. is ±3°C ±1 digit max. The indication accuracy of W thermocouples is (±0.3% of PV or ±3°C, whichever is greater) ±1 digit max. The indication accuracy of PL II thermocouples is (±0.3% of PV or ±2°C, whichever is greater) ±1 digit max.

\*2. Ambient temperature: -10°C to 23°C to 55°C, Voltage range: -15% to 10% of rated voltage

\*3. K thermocouple at -100°C max.: ±10°C max.

\*4. The unit is determined by the setting of the Integral/Derivative Time Unit parameter.

\*5. External communications (RS-485) and USB-serial conversion cable communications can be used at the same time.

\*6. Refer to your OMRON website for the most recent information on applicable models.

\*7. Industrial electromagnetic environment (EN/IEC 61326-1 Table 2)

## Program Control

|                                      |                                    |   |
|--------------------------------------|------------------------------------|---|
| <b>Number of programs (patterns)</b> |                                    | 8   |
| <b>Number of segments (steps)</b>    |                                    | 32  |
| <b>Segment setting method</b>        |                                    | Time setting (Segment set with set point and time.)                                 |
|                                      |                                    | Slope setting (Segment set with segment type, set point, slope, and time.)          |
| <b>Segment times</b>                 |                                    | 0 h 0 min to 99 h 59 min  |
|                                      |                                    | 0 min 0 s to 99 min 59 s  |
| <b>Alarm setting</b>                 |                                    | Set separately for each program.  |
| <b>Reset operation</b>               |                                    | Select either stopping control or fixed SP operation.                               |
| <b>Startup operation</b>             |                                    | Select continuing, resetting, manual operation, or run mode.                        |
| <b>PID sets</b>                      | <b>Number of sets</b>              | 8   |
|                                      | <b>Setting method</b>              | Set separately for each program (automatic PID group selection also supported).     |
| <b>Alarm SP function</b>             |                                    | Select from ramp SP and target SP.  |
| <b>Program status control</b>        | <b>Segment operation</b>           | Advance, segment jump, hold, and wait   |
|                                      | <b>Program operation</b>           | Program repetitions and program links   |
| <b>Wait operation</b>                | <b>Wait method</b>                 | Waiting at segment ends   |
|                                      | <b>Wait width setting</b>          | Same wait width setting for all programs  |
| <b>Time signals</b>                  | <b>Number of outputs</b>           | 2   |
|                                      | <b>Number of ON/OFF Operations</b> | 1 each per output   |
|                                      | <b>Setting method</b>              | Set separately for each program.  |
| <b>Program status output</b>         |                                    | Program end output (pulse width can be set), run output, stage output               |
| <b>Program startup operation</b>     | <b>PV start</b>                    | Select from segment 1 set point, slope-priority PV start                            |
|                                      | <b>Standby</b>                     | 0 h 0 min to 99 h 59 min  |
|                                      |                                    | 0 day 0 h to 99 day 23h   |
| <b>Operation end operation</b>       |                                    | Select from resetting, continuing control at final set point, and fixed SP control. |
| <b>Program SP shift</b>              |                                    | Same program SP shift for all programs  |

## USB-Serial Conversion Cable

|                                      |   |
|--------------------------------------|---|
| <b>Applicable OS</b>                 | Windows XP/Vista/7/8/10 *1  |
| <b>Applicable software</b>           | CX-Thermo version 4.61 or higher  |
| <b>Applicable models</b>             | E5□C-T Series, E5□C Series, and E5CB Series   |
| <b>USB interface standard</b>        | Conforms to USB Specification 2.0.  |
| <b>DTE speed</b>                     | 38400 bps   |
| <b>Connector specifications</b>      | Computer: USB (type A plug)<br>Digital Temperature Controller:<br>Special serial connector        |
| <b>Power supply</b>                  | Bus power (Supplied from USB host controller.) *2   |
| <b>Power supply voltage</b>          | 5 VDC   |
| <b>Current consumption</b>           | 450 mA max.   |
| <b>Output voltage</b>                | 4.7±0.2 VDC<br>(Supplied from USB-Serial Conversion Cable to the Digital Temperature Controller.) |
| <b>Output current</b>                | 250 mA max.<br>(Supplied from USB-Serial Conversion Cable to the Digital Temperature Controller.) |
| <b>Ambient operating temperature</b> | 0 to 55°C (with no condensation or icing)   |
| <b>Ambient operating humidity</b>    | 10% to 80%  |
| <b>Storage temperature</b>           | -20 to 60°C (with no condensation or icing)   |
| <b>Storage humidity</b>              | 10% to 80%  |
| <b>Altitude</b>                      | 2,000 m max.  |
| <b>Weight</b>                        | Approx. 120 g   |

Windows is a registered trademark of Microsoft Corporation in the United States and or other countries.

\*1. CX-Thermo version 4.65 or higher runs on Windows 10.

\*2. Use a high-power port for the USB port.

**Note:** A driver must be installed on the computer. Refer to the *Instruction Manual* included with the Cable for the installation procedure.

## Communications Specifications

|  |   |
|--|---|
| <b>Transmission line connection method</b> | RS-485: Multidrop   |
| <b>Communications</b>                      | RS-485 (two-wire, half duplex)  |
| <b>Synchronization method</b>              | Start-stop synchronization  |
| <b>Protocol</b>                            | CompoWay/F, or Modbus   |
| <b>Baud rate *</b>                         | 9600, 19200, 38400, or 57600 bps  |
| <b>Transmission code</b>                   | ASCII   |
| <b>Data bit length *</b>                   | 7 or 8 bits   |
| <b>Stop bit length *</b>                   | 1 or 2 bits   |
| <b>Error detection</b>                     | Vertical parity (none, even, odd)<br>Block check character (BCC) with CompoWay/F or CRC-16 Modbus |
| <b>Flow control</b>                        | None  |
| <b>Interface</b>                           | RS-485  |
| <b>Retry function</b>                      | None  |
| <b>Communications buffer</b>               | 217 bytes   |
| <b>Communications response wait time</b>   | 0 to 99 ms<br>Default: 20 ms  |

\* The baud rate, data bit length, stop bit length, and vertical parity can be individually set using the Communications Setting Level.

## Communications Functions

|                                     |  |
|-------------------------------------|--|
| <b>Programless communications *</b> | You can use the memory in the PLC to read and write E5□C-T parameters, start and reset operation, etc. The E5□C-T automatically performs communications with PLCs. No communications programming is required. Number of connected Digital Temperature Controllers: 32 max.<br>Applicable PLCs<br>OMRON PLCs<br>CS Series, CJ Series, or CP Series<br>Mitsubishi Electric PLCs<br>MELSEC Q Series, L Series |
|-------------------------------------|--|

|                                 |   |
|---------------------------------|---|
| <b>Component Communications</b> | When Digital Temperature Controllers are connected, set points and RUN/STOP commands can be sent from the Digital Temperature Controller that is set as the master to the Digital Temperature Controllers that are set as slaves. Slope and offsets can be set for the set point. Number of connected Digital Temperature Controllers: 32 max. (including master) |
| <b>Copying *</b>                | When Digital Temperature Controllers are connected, the parameters can be copied from the Digital Temperature Controller that is set as the master to the Digital Temperature Controllers that are set as slaves.   |

MELSEC is a registered trademark of Mitsubishi Electric Corporation.

\* Both the programless communications and the component communications support the copying.

## Current Transformer (Order Separately) Ratings

|                                   |   |
|-----------------------------------|---|
| <b>Dielectric strength</b>        | 1,000 VAC for 1 min                               |
| <b>Vibration resistance</b>       | 50 Hz, 98 m/s <sup>2</sup>                        |
| <b>Weight</b>                     | E54-CT1: Approx. 11.5 g,<br>E54-CT3: Approx. 50 g |
| <b>Accessories (E54-CT3 only)</b> | Armatures (2)<br>Plugs (2)                        |

## Heater Burnout Alarms and SSR Failure Alarms

|  |   |
|--|---|
| <b>CT input (for heater current detection)</b> | Models with detection for single-phase heaters: One input<br>Models with detection for singlephase or three-phase heaters: Two inputs |
| <b>Maximum heater current</b>                  | 50 A AC   |
| <b>Input current indication accuracy</b>       | ±5% FS ±1 digit max.  |
| <b>Heater burnout alarm setting range *1</b>   | 0.1 to 49.9 A (in units of 0.1 A)<br>Minimum detection ON time: 100 ms *3   |
| <b>SSR failure alarm setting range *2</b>      | 0.1 to 49.9 A (in units of 0.1 A)<br>Minimum detection OFF time: 100 ms *4  |

\*1. For heater burnout alarms, the heater current will be measured when the control output is ON, and the output will turn ON if the heater current is lower than the set value (i.e., heater burnout detection current value).

\*2. For SSR failure alarms, the heater current will be measured when the control output is OFF, and the output will turn ON if the heater current is higher than the set value (i.e., SSR failure detection current value).

\*3. The value is 30 ms for a control period of 0.1 s or 0.2 s.

\*4. The value is 35 ms for a control period of 0.1 s or 0.2 s.

## Electrical Life Expectancy Curve for Relays (Reference Values)

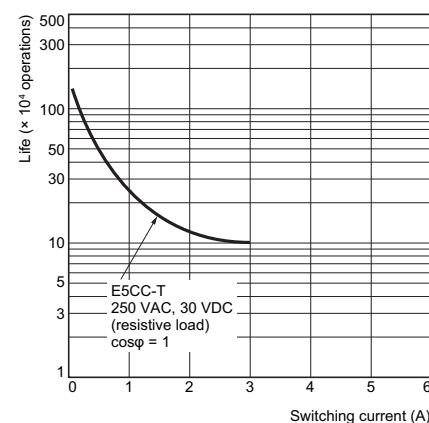

# E5CC-T

## External Connections

### E5CC-T

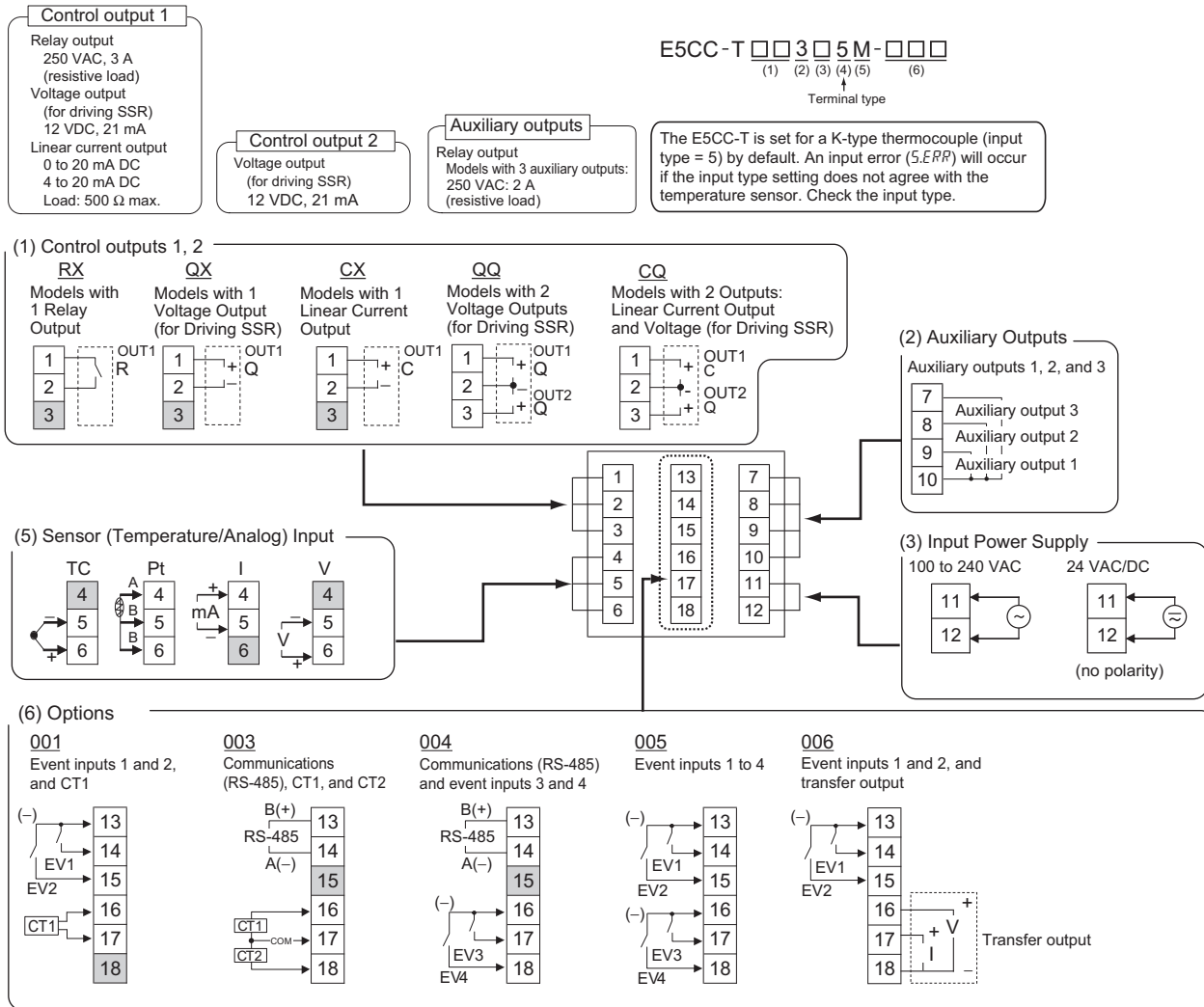

Use no-voltage inputs for the event inputs.  
The polarity for non-contact inputs is given in parentheses.

- Note:**
- The application of the terminals depends on the model.
  - Do not wire the terminals that are shown with a gray background.
  - When complying with EMC standards, the cable that connects the sensor must be 30 m or less. If the cable length exceeds 30 m, compliance with EMC standards will not be possible.
  - Connect M3 crimped terminals.

## Isolation/Insulation Block Diagrams

### Models with 3 Auxiliary Outputs

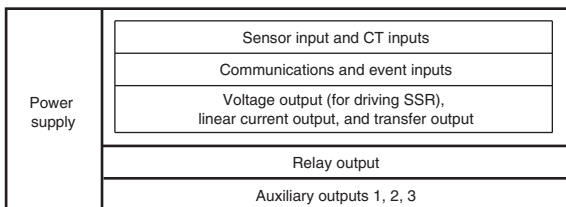

- Reinforced insulation
- Functional isolation

**Note:** Auxiliary outputs 1 to 3 are not insulated.

## Nomenclature

### E5CC-T

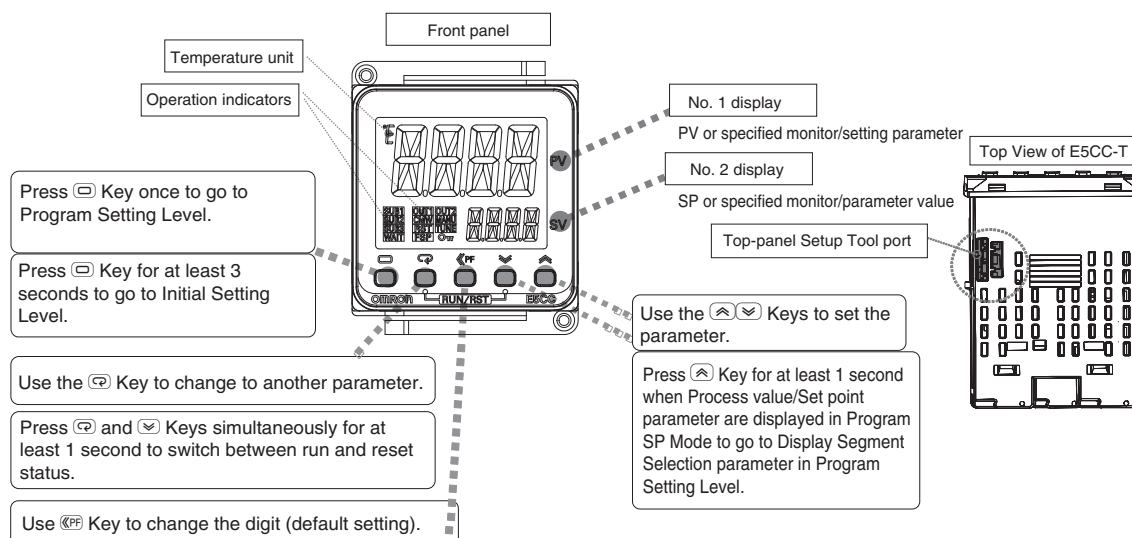

## Dimensions

(Unit: mm)

### Controllers

#### E5CC-T

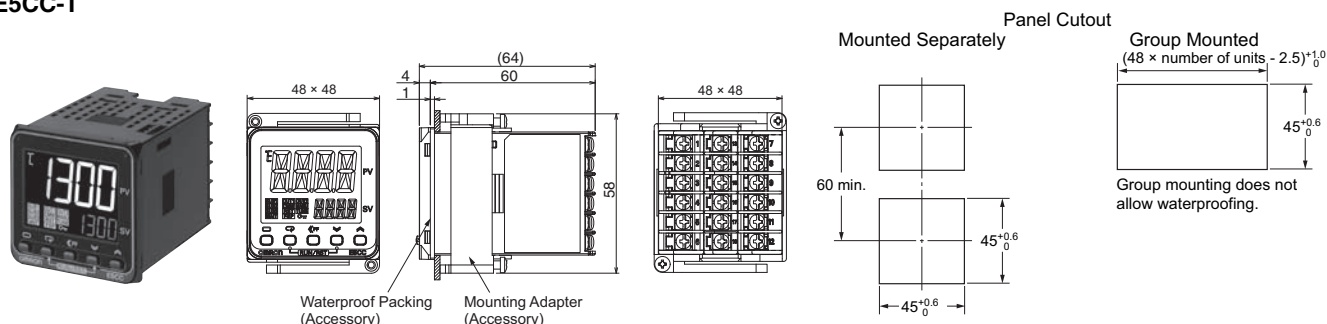

The Setup Tool port is on the top of the Temperature Controller. It is used to connect the Temperature Controller to the computer to use the Setup Tool.

The E58-CIFQ2 USB-Serial Conversion Cable is required to make the connection.

Refer to the instructions that are provided with the USB-Serial Conversion Cable for the connection procedure.

**Note:** Do not leave the USB-Serial Conversion Cable connected when you use the Temperature Controller.

- Recommended panel thickness is 1 to 5 mm.
- Group mounting is not possible in the vertical direction. (Maintain the specified mounting space between Controllers.)
- To mount the Controller so that it is waterproof, insert the waterproof packing onto the Controller.
- When two or more Controllers are mounted, make sure that the surrounding temperature does not exceed the allowable operating temperature specified in the specifications.
- Use a control panel thickness of 1 to 3 mm if the Y92A-48N and a USB-Serial Conversion Cable are used together.

## Accessories (Order Separately)

### USB-Serial Conversion Cable

E58-CIFQ2

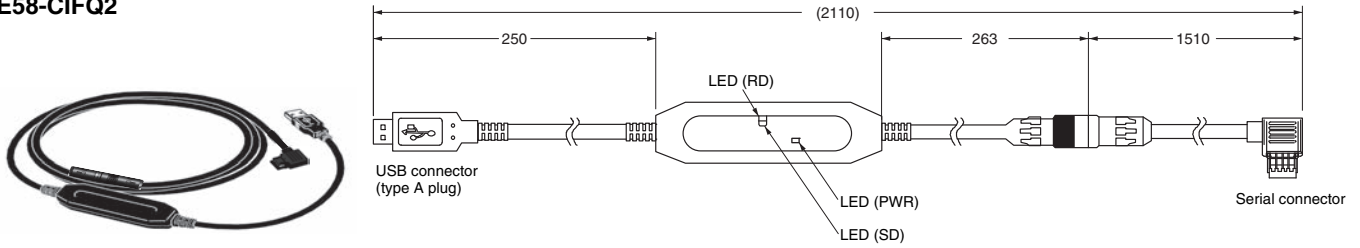

### Terminal Covers

E53-COV17

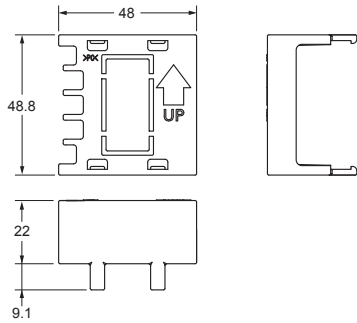
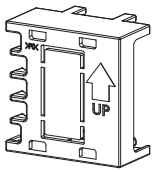

### Terminal Covers

E53-COV23 (Three Covers provided.)

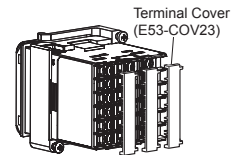
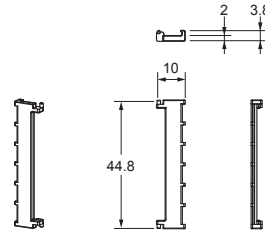

### Waterproof Packing

Y92S-P8 (for DIN 48 × 48)

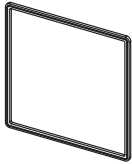

The Waterproof Packing is provided with the Temperature Controller. Order the Waterproof Packing separately if it becomes lost or damaged. The Waterproof Packing can be used to achieve an IP66 degree of protection. (Deterioration, shrinking, or hardening of the waterproof packing may occur depending on the operating environment. Therefore, periodic replacement is recommended to ensure the level of waterproofing specified in IP66. The time for periodic replacement depends on the operating environment. Be sure to confirm this point at your site. Consider three years as a rough standard.)



Current Transformers

E54-CT1

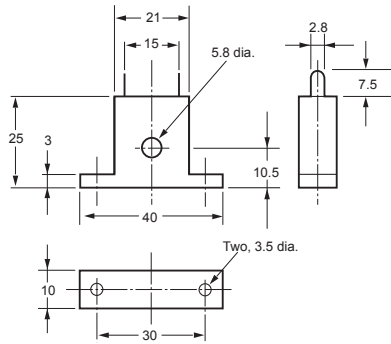
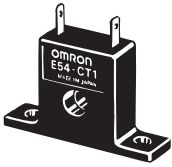

E54-CT3

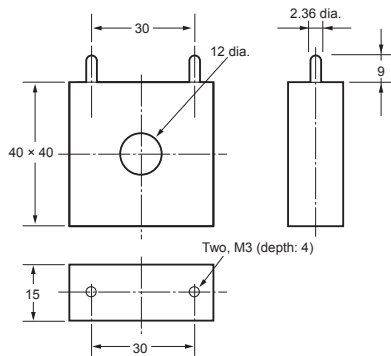

E54-CT3 Accessories

• Armature

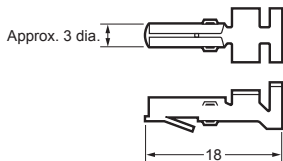

• Plug

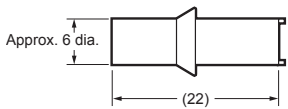

Connection Example

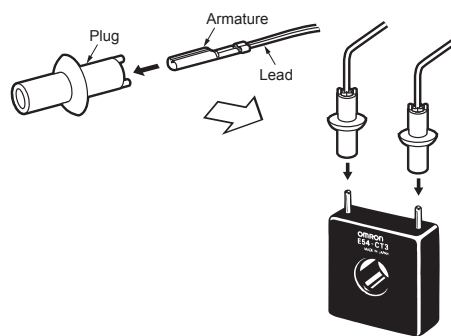

Thru-current ( $I_o$ ) vs. Output Voltage ( $E_o$ ) (Reference Values)

E54-CT1

Maximum continuous heater current: 50 A (50/60 Hz)  
 Number of windings: 400±2  
 Winding resistance: 18±2 Ω

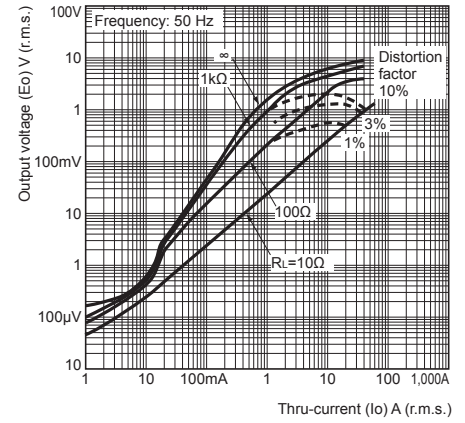

Thru-current ( $I_o$ ) vs. Output Voltage ( $E_o$ ) (Reference Values)

E54-CT3

Maximum continuous heater current: 120 A (50/60 Hz)  
 (Maximum continuous heater current for an OMRON Digital Temperature Controller is 50 A.)  
 Number of windings: 400±2  
 Winding resistance: 8±0.8 Ω

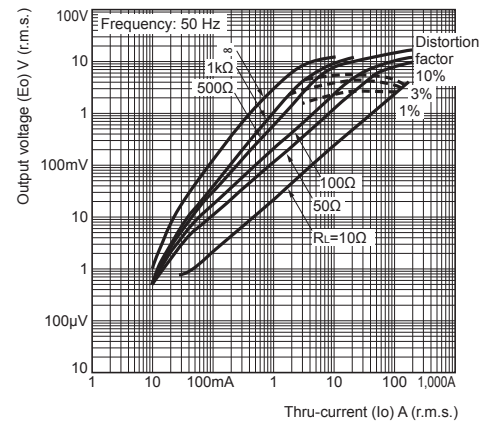

# E5CC-T

## Adapter

### Y92F-45

- Note:** 1. Use this Adapter when the Front Panel has already been prepared for the E5B□.  
 2. Only black is available.  
 3. You cannot use the E58-CIFQ2 USB-Serial Conversion Cable if you use the Y92F-45 Adapter. To use the USB-Serial Conversion Cable to make the settings, do so before you mount the Temperature Controller in the panel.  
 4. You cannot use this Adapter together with the Y92F-49 Adapter that is provided with the E5CC-T Temperature Controller.

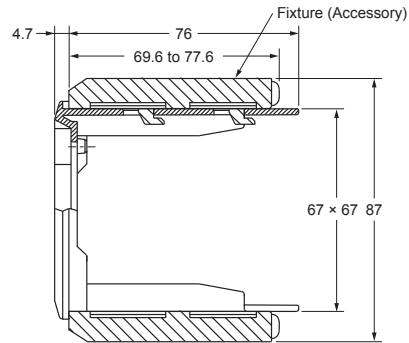
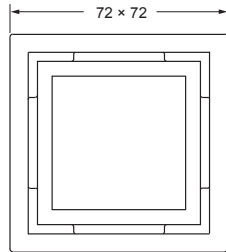
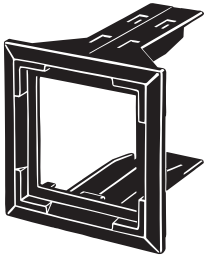

### Mounted to E5CC-T

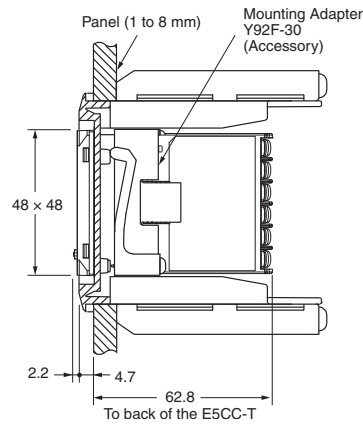
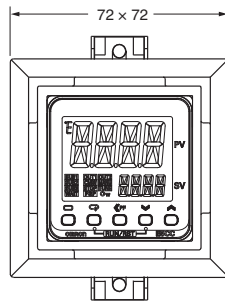
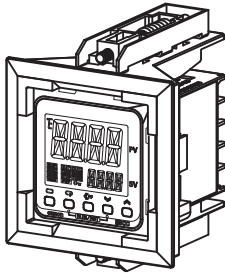

## DIN Track Mounting Adapter

### Y92F-52

- Note:** This Adapter cannot be used together with the Terminal Cover.  
 Remove the Terminal Cover to use the Adapter.

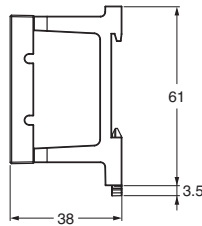
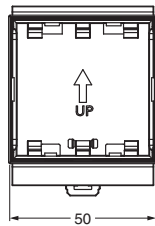
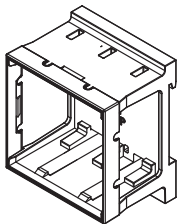

This Adapter is used to mount the E5CC-T to a DIN Track. If you use the Adapter, there is no need for a plate to mount in the panel or to drill mounting holes in the panel.

### Mounted to E5CC-T

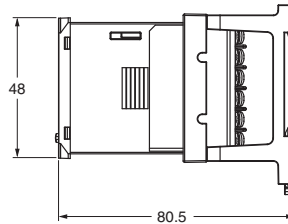
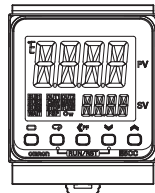
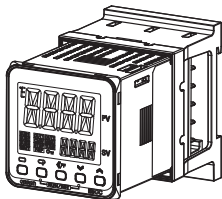

### Watertight Cover Y92A-48N

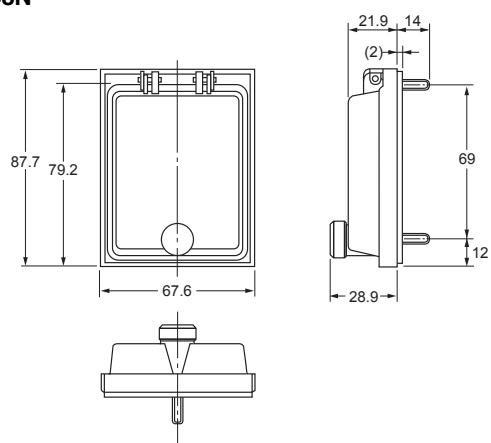

### Mounting Adapter Y92F-49

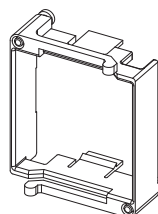

The Mounting Adapter is provided with the Temperature Controller.  
Order this Adapter separately if it becomes lost or damaged.

### Protective Cover Y92A-48D

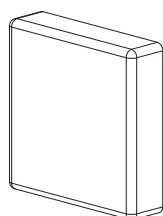

**Note:** This Protective Cover cannot be used if the Waterproof Packing is installed.

This Protective Cover is soft type.  
It is able to operate the controller with using this cover.

### Protective Cover Y92A-48H

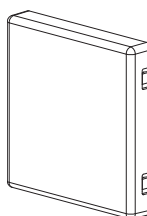

This Protective Cover is hard type.  
Please use it for the mis-operation prevention etc.

# Programmable Temperature Controller (Digital Controller)

# E5EC-T/E5AC-T

(48 × 96 mm/96 × 96 mm)

## Programmable Controllers Join the E5□C Series! Program up to 256 segments can handle a wide variety of applications.

- Set up to 8 Programs (Patterns) with 32 Segments (Steps) Each
- A white LCD PV display with a height of approx. 18 mm for the E5EC-T and 25 mm for the E5AC-T improves visibility.
- Tool ports are provided both on the top panel and the front panel. Set up the Controller without wiring the power supply by connecting to the computer with a Communications Conversion Cable (sold separately). Setup is easy with the CX-Thermo (sold separately).
- High-speed sampling at 50 ms.
- Models are available with up to 4 auxiliary outputs, up to 6 event inputs, and a transfer output to cover a wide range of applications.
- Short body with depth of only 60 mm.
- Easy connections to a PLC with programless communications. Use component communications to link Temperature Controllers to each other.
- The new position-proportional control models allow you to control valves as well.



48 × 96 mm  
E5EC-T

96 × 96 mm  
E5AC-T

Refer to your OMRON website for the most recent information on applicable safety standards.

Refer to Safety Precautions on page 108.

## Main I/O Functions

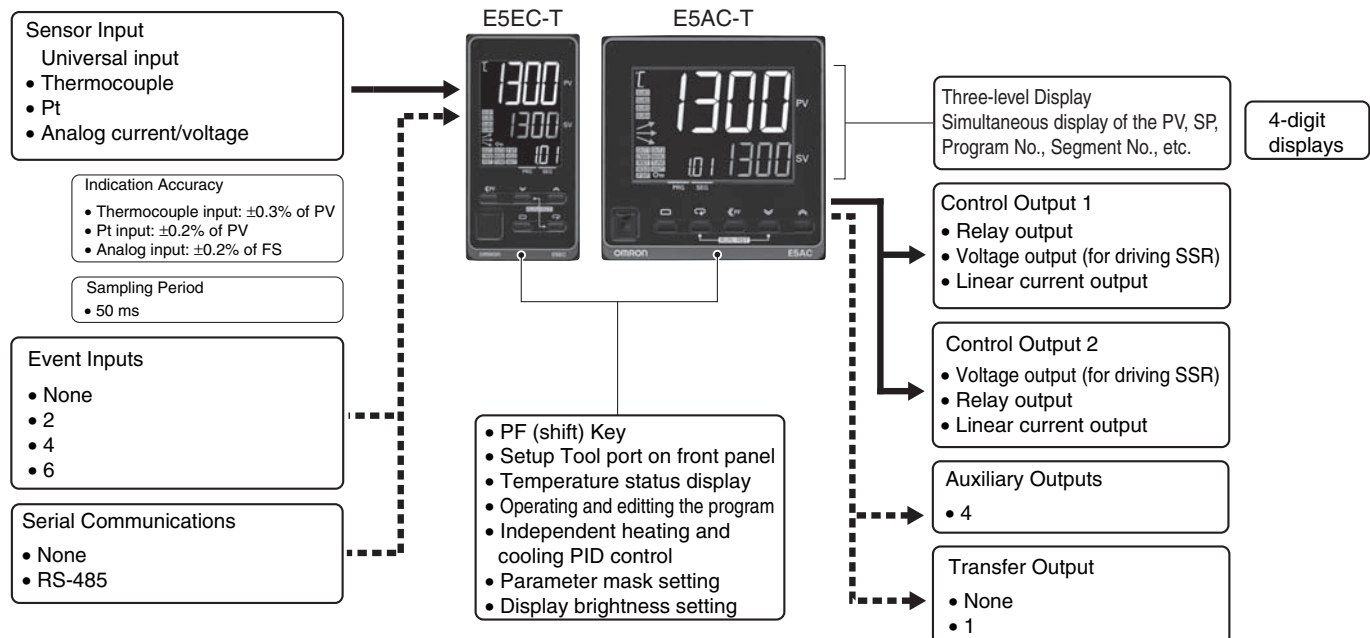

This datasheet is provided as a guideline for selecting products.

Be sure to refer to the following manuals for application precautions and other information required for operation before attempting to use the product.

E5□C-T Digital Temperature Controllers Programmable Type User's Manual (Cat. No. H185)

E5□C-T Digital Temperature Controllers Programmable Type Communications Manual (Cat. No. H186)

## Model Number Legend and Standard Models

### Model Number Legend

Models with Screw Terminal Blocks

E5EC-T□□ 4 □ 5 M-□□□ (Example: E5EC-TRX4A5M-000)

① ② ③ ④ ⑤ ⑥

E5AC-T□□ 4 □ 5 M-□□□ (Example: E5AC-TRX4A5M-000)

① ② ③ ④ ⑤ ⑥

| Model  | ①                       | ②                        | ③                    | ④             | ⑤          | ⑥                                  | Meaning   |                                    |
|--------|-------------------------|--------------------------|----------------------|---------------|------------|------------------------------------|---|------------------------------------|
|        | Control outputs 1 and 2 | No. of auxiliary outputs | Power supply voltage | Terminal type | Input type | Options                            | Control output 1  | Control output 2                   |
| E5EC-T |                         |                          |                      |               |            |                                    | 48 × 96 mm Programmable Type  |                                    |
| E5AC-T |                         |                          |                      |               |            |                                    | 96 × 96 mm Programmable Type  |                                    |
| *2     | RX                      |                          |                      |               |            |                                    | Relay output  | None                               |
|        | QX                      |                          |                      |               |            |                                    | Voltage output (for driving SSR)  | None                               |
|        | CX                      |                          |                      |               |            |                                    | Linear current output   | None                               |
|        | QQ                      |                          |                      |               |            |                                    | Voltage output (for driving SSR)  | Voltage output (for driving SSR)   |
|        | QR                      |                          |                      |               |            |                                    | Voltage output (for driving SSR)  | Relay output                       |
|        | RR                      |                          |                      |               |            |                                    | Relay output  | Relay output                       |
|        | *2 CC                   |                          |                      |               |            |                                    | Linear current output   | Linear current output              |
|        | *2 CQ                   |                          |                      |               |            |                                    | Linear current output   | Voltage output (for driving SSR)   |
|        | PR                      |                          |                      |               |            |                                    | Position-proportional relay output  | Position-proportional relay output |
|        |                         |                          | 4                    |               |            |                                    | 4 (auxiliary outputs 1 and 2 with same common and auxiliary outputs 3 and 4 with same common) |                                    |
|        |                         |                          | A                    |               |            | 100 to 240 VAC                     |   |                                    |
|        |                         |                          | D                    |               |            | 24 VAC/DC                          |   |                                    |
|        |                         |                          | 5                    |               |            | Screw terminal blocks (with cover) |   |                                    |
|        |                         |                          |                      | M             |            | Universal input                    |   |                                    |

| Option selection conditions *1 | Control outputs 1 and 2       |              |        |     | HB alarm and HS alarm | Communications | Event inputs | Transfer output |
|--------------------------------|-------------------------------|--------------|--------|-----|-----------------------|----------------|--------------|-----------------|
|                                | For RX, QX, QQ, QR, RR, or CQ | For CX or CC | For PR |     |                       |                |              |                 |
| Selectable                     | Selectable                    | Selectable   |        | 000 | ---                   | ---            | ---          | ---             |
|                                | Selectable                    | Selectable   |        | 004 | ---                   | RS-485         | 2            | ---             |
|                                | Selectable                    |              |        | 005 | ---                   | ---            | 4            | ---             |
| Selectable                     |                               |              |        | 008 | 1                     | RS-485         | 2            | ---             |
| Selectable                     |                               |              |        | 010 | 1                     | ---            | 4            | ---             |
| Selectable                     |                               |              |        | 019 | 1                     | ---            | 6            | Provided.       |
|                                | Selectable                    |              |        | 021 | ---                   | ---            | 6            | Provided.       |
|                                | Selectable                    | Selectable   |        | 022 | ---                   | RS-485         | 4            | Provided.       |

\*1. The options that can be selected depend on the type of control output.

\*2. The linear current output cannot be used as a transfer output.

## Heating and Cooling Control

### Using Heating and Cooling Control

#### ① Control Output Assignment

If there is no control output 2, an auxiliary output is used as the cooling control output.

If there is a control output 2, the two control outputs are used for heating and cooling.

(It does not matter which output is used for heating and which output is used for cooling.)

#### ② Control

If PID control is used, you can set PID control separately for heating and cooling.

This allows you to handle control systems with different heating and cooling response characteristics.

# E5EC-T/E5AC-T

## Optional Products (Order Separately)

### USB-Serial Conversion Cable

| Model     |
|-----------|
| E58-CIFQ2 |

### Communications Conversion Cable

| Model       |
|-------------|
| E58-CIFQ2-E |

**Note:** Always use this product together with the E58-CIFQ2.  
This Cable is used to connect to the front-panel Setup Tool port.

### Terminal Covers

| Model            |
|------------------|
| E53-COV24 (3pcs) |

**Note:** The Terminal Covers E53-COV24 are provided with the Digital Temperature Controller.

### Waterproof Packing

| Applicable Controller | Model    |
|-----------------------|----------|
| E5EC-T                | Y92S-P9  |
| E5AC-T                | Y92S-P10 |

**Note:** This Waterproof Packing is provided with the Digital Temperature Controller.

### Waterproof Cover

| Applicable Controller | Model    |
|-----------------------|----------|
| E5EC-T                | Y92A-49N |
| E5AC-T                | Y92A-96N |

### Front Port Cover

| Model   |
|---------|
| Y92S-P7 |

**Note:** This Front Port Cover is provided with the Digital Temperature Controller.

### Mounting Adapter

| Model          |
|----------------|
| Y92F-51 (2pcs) |

**Note:** This Mounting Adapter is provided with the Digital Temperature Controller.

### Current Transformers (CTs)

| Hole diameter | Model   |
|---------------|---------|
| 5.8 mm        | E54-CT1 |
| 12.0 mm       | E54-CT3 |

### CX-Thermo Support Software

| Model       |
|-------------|
| EST2-2C-MV4 |

**Note:** CX-Thermo version 4.61 or higher is required for the E5EC-T/E5AC-T.  
For the system requirements for the CX-Thermo, refer to information on the EST2-2C-MV4 on the OMRON website ([www.ia.omron.com](http://www.ia.omron.com)).

## Specifications

### Ratings

|                                      |  |   |
|--------------------------------------|--|---|
| <b>Power supply voltage</b>          |  | A in model number: 100 to 240 VAC, 50/60 Hz<br>D in model number: 24 VAC, 50/60 Hz; 24 VDC  |
| <b>Operating voltage range</b>       |  | 85 to 110% of rated supply voltage  |
| <b>Power consumption</b>             | <b>E5EC-T</b>                                | 8.7 VA max. at 100 to 240 VAC, and 5.5 VA max. at 24 VAC or 3.2 W max. at 24 VDC  |
|                                      | <b>E5AC-T</b>                                | 9.0 VA max. at 100 to 240 VAC, and 5.6 VA max. at 24 VAC or 3.4 W max. at 24 VDC  |
| <b>Sensor input</b>                  |  | Temperature input<br>Thermocouple: K, J, T, E, L, U, N, R, S, B, W, or PL II<br>Platinum resistance thermometer: Pt100 or JPt100<br>Infrared temperature sensor (ES1B): 10 to 70°C, 60 to 120°C, 115 to 165°C, or 140 to 260°C<br>Analog input<br>Current input: 4 to 20 mA or 0 to 20 mA<br>Voltage input: 1 to 5 V, 0 to 5 V, or 0 to 10 V  |
| <b>Input impedance</b>               |  | Current input: 150 Ω max., Voltage input: 1 MΩ min.<br>(Use a 1:1 connection when connecting the ES2-HB/THB.)   |
| <b>Control method</b>                |  | 2-PID control (with auto-tuning) or ON/OFF control  |
| <b>Control output</b>                | <b>Relay output</b>                          | SPST-NO, 250 VAC, 5 A (resistive load), electrical life: 100,000 operations, minimum applicable load: 5 V, 10 mA (reference value)  |
|                                      | <b>Voltage output (for driving SSR)</b>      | Output voltage: 12 VDC ±20% (PNP), max. load current: 40 mA, with short-circuit protection circuit (The maximum load current is 21 mA for models with two control outputs.)   |
|                                      | <b>Linear current output</b>                 | 4 to 20 mA DC/0 to 20 mA DC, load: 500 Ω max., resolution: approx. 10,000   |
| <b>Auxiliary output</b>              | <b>Number of outputs</b>                     | 4   |
|                                      | <b>Output specifications</b>                 | SPST-NO. relay outputs, 250 VAC, Models with 4 outputs: 2 A (resistive load), Electrical life: 100,000 operations, Minimum applicable load: 10 mA at 5 V (reference value)  |
| <b>Event input</b>                   | <b>Number of inputs</b>                      | 2, 4 or 6 (depends on model)  |
|                                      | <b>External contact input specifications</b> | Contact input: ON: 1 kΩ max., OFF: 100 kΩ min.  |
|                                      |  | Non-contact input: ON: Residual voltage: 1.5 V max., OFF: Leakage current: 0.1 mA max.<br>Current flow: Approx. 7 mA per contact  |
| <b>Transfer output</b>               | <b>Number of outputs</b>                     | 1 (only on models with a transfer output)   |
|                                      | <b>Output specifications</b>                 | Current output: 4 to 20 mA DC, Load: 500 Ω max., Resolution: Approx. 10,000<br>Linear voltage output: 1 to 5 VDC, load: 1 kΩ min., Resolution: Approx. 10,000   |
| <b>Potentiometer input</b>           |  | 100 Ω to 10 kΩ  |
| <b>Setting method</b>                |  | Digital setting using front panel keys  |
| <b>Indication method</b>             |  | 11-segment digital display and individual indicators<br>Character height: E5EC-T: PV: 18.0 mm, SV: 11.0 mm, MV: 7.8 mm<br>E5AC-T: PV: 25.0 mm, SV: 15.0 mm, MV: 9.5 mm<br>Three displays. Contents: PV, SP, program No. and segment No., remaining segment time, or MV (valve opening)<br>Numbers of digits: 4 digits   |
| <b>Bank switching</b>                |  | None  |
| <b>Other functions</b>               |  | Manual output, heating/cooling control, loop burnout alarm, other alarm functions, heater burnout (HB) alarm (including SSR failure (HS) alarm), 40% AT, 100% AT, MV limiter, input digital filter, robust tuning, PV input shift, protection functions, extraction of square root, MV change rate limit, logic operations, temperature status display, moving average of input value, and display brightness setting |
| <b>Ambient operating temperature</b> |  | -10 to 55°C (with no condensation or icing), For 3-year warranty: -10 to 50°C with standard mounting (with no condensation or icing)  |
| <b>Ambient operating humidity</b>    |  | 25 to 85%   |
| <b>Storage temperature</b>           |  | -25 to 65°C (with no condensation or icing)   |
| <b>Altitude</b>                      |  | 2,000 m max.  |
| <b>Recommended fuse</b>              |  | T2A, 250 VAC, time-lag, low-breaking capacity   |
| <b>Installation environment</b>      |  | Overvoltage category II, Pollution Degree 2 (EN/IEC/UL 61010-1)   |

## Input Ranges

### Thermocouple/Platinum Resistance Thermometer (Universal inputs)

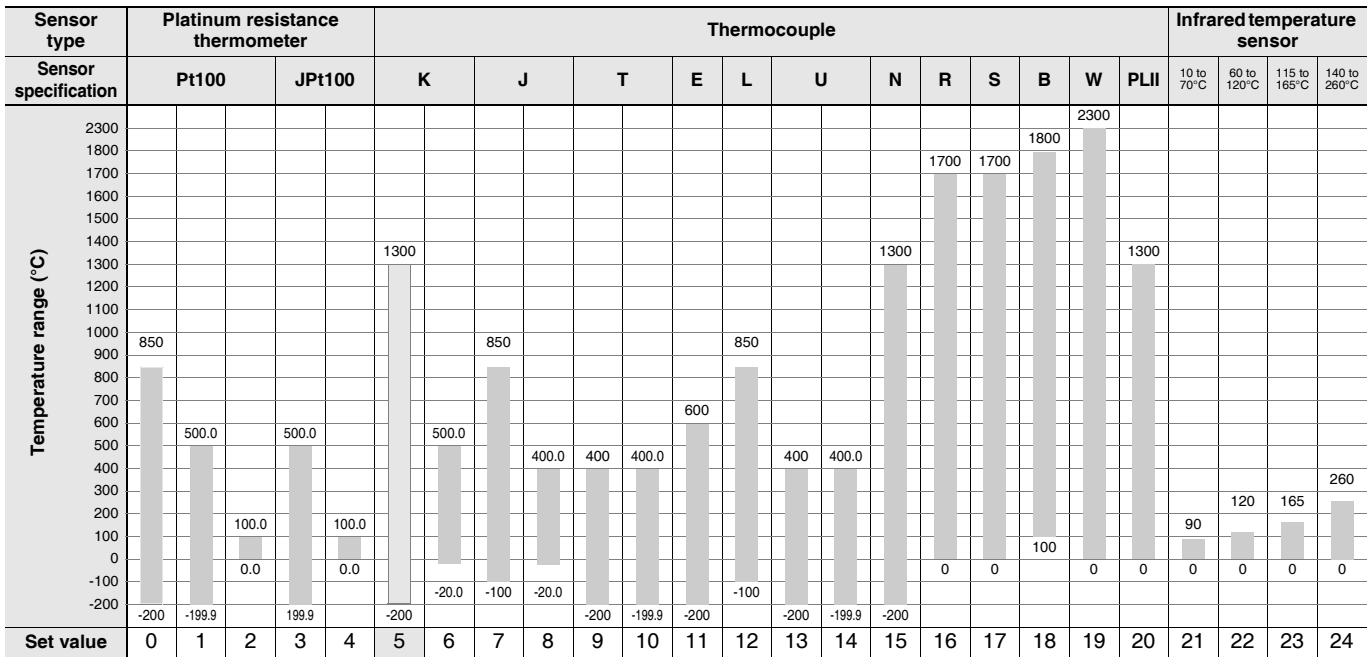

Shaded settings are the default settings.

The applicable standards for the input types are as follows:

K, J, T, E, N, R, S, B: JIS C 1602-1995, IEC 60584-1

JPt100: JIS C 1604-1989, JIS C 1606-1989

L: Fe-CuNi, DIN 43710-1985

Pt100: JIS C 1604-1997, IEC 60751

U: Cu-CuNi, DIN 43710-1985

PL II: According to Platinel II electromotive force charts from BASF (previously Engelhard)

W: W5Re/W26Re, ASTM E988-1990

## Analog input

| Input type          | Current   |            | Voltage  |          |           |
|---------------------|---|------------|----------|----------|-----------|
| Input specification | 4 to 20 mA  | 0 to 20 mA | 1 to 5 V | 0 to 5 V | 0 to 10 V |
| Setting range       | Usable in the following ranges by scaling:<br>-1999 to 9999, -199.9 to 999.9,<br>-19.99 to 99.99 or -1.999 to 9.999 |            |          |          |           |
| Set value           | 25  | 26         | 27       | 28       | 29        |



## Alarm Types

Each alarm can be independently set to one of the following 17 alarm types. The default is 2: Upper limit. (see note.)

Auxiliary outputs are allocated for alarms. ON delays and OFF delays (0 to 999 s) can also be specified.

**Note:** In the default settings for models with HB or HS alarms, alarm 1 is set to a heater alarm (HA) and the Alarm Type 1 parameter is not displayed. To use alarm 1, set the output assignment to alarm 1.

| Set value   | Alarm type                                       | Alarm output operation                   |   | Description of function  |
|-------------|--|--|---|--|
|             |  | When alarm value X is positive           | When alarm value X is negative                    |  |
| 0           | Alarm function OFF                               | Output OFF                               |   | No alarm   |
| 1           | Upper- and lower-limit *1                        |  | *2  | Set the upward deviation in the set point for the alarm upper limit (H) and the lower deviation in the set point for the alarm lower limit (L). The alarm is ON when the PV is outside this deviation range. |
| 2 (default) | Upper-limit                                      |  |   | Set the upward deviation in the set point by setting the alarm value (X). The alarm is ON when the PV is higher than the SP by the deviation or more.  |
| 3           | Lower-limit                                      |  |   | Set the downward deviation in the set point by setting the alarm value (X). The alarm is ON when the PV is lower than the SP by the deviation or more.   |
| 4           | Upper- and lower-limit range *1                  |  | *3  | Set the upward deviation in the set point for the alarm upper limit (H) and the lower deviation in the set point for the alarm lower limit (L). The alarm is ON when the PV is inside this deviation range.  |
| 5           | Upper- and lower-limit with standby sequence *1  |  | *4  | A standby sequence is added to the upper- and lower-limit alarm (1). *6  |
| 6           | Upper-limit with standby sequence                |  |   | A standby sequence is added to the upper-limit alarm (2). *6   |
| 7           | Lower-limit with standby sequence                |  |   | A standby sequence is added to the lower-limit alarm (3). *6   |
| 8           | Absolute-value upper-limit                       |  |   | The alarm will turn ON if the process value is larger than the alarm value (X) regardless of the set point.  |
| 9           | Absolute-value lower-limit                       |  |   | The alarm will turn ON if the process value is smaller than the alarm value (X) regardless of the set point.   |
| 10          | Absolute-value upper-limit with standby sequence |  |   | A standby sequence is added to the absolute-value upper-limit alarm (8). *6  |
| 11          | Absolute-value lower-limit with standby sequence |  |   | A standby sequence is added to the absolute-value lower-limit alarm (9). *6  |
| 12          | LBA (alarm 1 type only)                          | -  |   | *7   |
| 13          | PV change rate alarm                             | -  |   | *8   |
| 14          | SP absolute-value upper-limit alarm              |  |   | This alarm type turns ON the alarm when the set point (SP) is higher than the alarm value (X).   |
| 15          | SP absolute-value lower-limit alarm              |  |   | This alarm type turns ON the alarm when the set point (SP) is lower than the alarm value (X).  |
| 16          | MV absolute-value upper-limit alarm *9           | Standard Control<br>                     | Standard Control<br>                              | This alarm type turns ON the alarm when the manipulated variable (MV) is higher than the alarm value (X).  |
|             |  | Heating/Cooling Control (Heating MV)<br> | Heating/Cooling Control (Heating MV)<br>Always ON |  |
| 17          | MV absolute-value lower-limit alarm *9           | Standard Control<br>                     | Standard Control<br>                              | This alarm type turns ON the alarm when the manipulated variable (MV) is lower than the alarm value (X).   |
|             |  | Heating/Cooling Control (Cooling MV)<br> | Heating/Cooling Control (Cooling MV)<br>Always ON |  |

**\*1.** With set values 1, 4 and 5, the upper and lower limit values can be set independently for each alarm type, and are expressed as "L" and "H."

**\*2.** Set value: 1, Upper- and lower-limit alarm

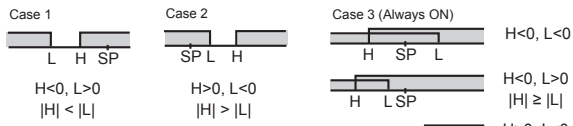

**\*3.** Set value: 4, Upper- and lower-limit range

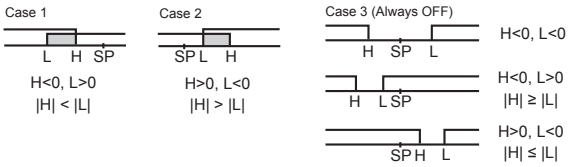

**\*4.** Set value: 5, Upper- and lower-limit with standby sequence  
For Upper- and Lower-Limit Alarm Described Above \*2

- Case 1 and 2  
Always OFF when the upper-limit and lower-limit hysteresis overlaps.
- Case 3: Always OFF

**\*5.** Set value: 5, Upper- and lower-limit with standby sequence  
Always OFF when the upper-limit and lower-limit hysteresis overlaps.

**\*6.** Refer to the *E5□C-T Digital Temperature Controllers Programmable Type User's Manual* (Cat. No. H185) for information on the operation of the standby sequence.

**\*7.** Refer to the *E5□C-T Digital Temperature Controllers Programmable Type User's Manual* (Cat. No. H185) for information on the loop burnout alarm (LBA). This setting cannot be used with a position-proportional model.

**\*8.** Refer to the *E5□C-T Digital Temperature Controllers Programmable Type User's Manual* (Cat. No. H185) for information on the PV change rate alarm.

**\*9.** When heating/cooling control is performed, the MV absolute upper limit alarm functions only for the heating operation and the MV absolute lower limit alarm functions only for the cooling operation.

## Characteristics

|   |  |  |
|---|--|--|
| <b>Indication accuracy<br/>(at the ambient temperature of<br/>23°C)</b> |  | Thermocouple: (±0.3% of indication value or ±1°C, whichever is greater) ±1 digit max. *1<br>Platinum resistance thermometer: (±0.2% of indication value or ±0.8°C, whichever is greater) ±1 digit max.<br>Analog input: ±0.2% FS ±1 digit max.<br>CT input: ±5% FS ±1 digit max.<br>Potentiometer input: ±5% FS ±1 digit max.  |
| <b>Transfer output accuracy</b>   |  | ±0.3% FS max.  |
| <b>Influence of temperature *2</b>                                      |  | Thermocouple input (R, S, B, W, PL II): (±1% of indication value or ±10°C, whichever is greater) ±1 digit max.<br>Other thermocouple input: (±1% of indication value or ±4°C, whichever is greater) ±1 digit max. *3<br>Platinum resistance thermometer: (±1% of indication value or ±2°C, whichever is greater) ±1 digit max. |
| <b>Influence of voltage *2</b>  |  | Analog input: ±1% FS ±1 digit max.<br>CT input: ±5% FS ±1 digit max.   |
| <b>Influence of EMS.<br/>(at EN 61326-1)</b>                            |  |  |
| <b>Input sampling period</b>  |  | 50ms   |
| <b>Hysteresis</b>   |  | Temperature input: 0.1 to 999.9°C or °F (in units of 0.1°C or °F)<br>Analog input: 0.01% to 99.99% FS (in units of 0.01% FS)   |
| <b>Proportional band (P)</b>  |  | Temperature input: 0.1 to 999.9°C or °F (in units of 0.1°C or °F)<br>Analog input: 0.1 to 999.9% FS (in units of 0.1% FS)  |
| <b>Integral time (I)</b>  |  | Standard, heating/cooling, or Position-proportional (Close): 0 to 9999 s (in units of 1 s), 0.0 to 999.9 s (in units of 0.1 s)<br>Position-proportional (Floating): 1 to 9999 s (in units of 1 s), 0.1 to 999.9 s (in units of 0.1 s) *4   |
| <b>Derivative time (D)</b>  |  | 0 to 9999 s (in units of 1 s), 0.0 to 999.9 s (in units of 0.1 s) *4   |
| <b>Proportional band (P) for cooling</b>                                |  | Temperature input: 0.1 to 999.9°C or °F (in units of 0.1°C or °F)<br>Analog input: 0.1 to 999.9% FS (in units of 0.1% FS)  |
| <b>Integral time (I) for cooling</b>                                    |  | 0 to 9999 s (in units of 1 s), 0.0 to 999.9 s (in units of 0.1 s) *4   |
| <b>Derivative time (D) for cooling</b>                                  |  | 0 to 9999 s (in units of 1 s), 0.0 to 999.9 s (in units of 0.1 s) *4   |
| <b>Control period</b>   |  | 0.1, 0.2, 0.5, 1 to 99 s (in units of 1 s)   |
| <b>Manual reset value</b>   |  | 0.0 to 100.0% (in units of 0.1%)   |
| <b>Alarm setting range</b>  |  | -1999 to 9999 (decimal point position depends on input type)   |
| <b>Influence of signal source<br/>resistance</b>                        |  | Thermocouple: 0.1°C/Ω max. (100 Ω max.)<br>Platinum resistance thermometer: 0.1°C/Ω max. (10 Ω max.)   |
| <b>Insulation resistance</b>  |  | 20 MΩ min. (at 500 VDC)  |
| <b>Dielectric strength</b>  |  | 3,000 VAC, 50/60 Hz for 1 min between terminals of different charge  |
| <b>Vibration</b>  | <b>Malfunction</b>   | 10 to 55 Hz, 20 m/s <sup>2</sup> for 10 min each in X, Y, and Z directions   |
|   | <b>Resistance</b>  | 10 to 55 Hz, 20 m/s <sup>2</sup> for 2 hrs each in X, Y, and Z directions  |
| <b>Shock</b>  | <b>Malfunction</b>   | 100 m/s <sup>2</sup> , 3 times each in X, Y, and Z directions  |
|   | <b>Resistance</b>  | 300 m/s <sup>2</sup> , 3 times each in X, Y, and Z directions  |
| <b>Weight</b>   | <b>E5EC-T</b>  | Controller: Approx. 210 g, Adapter: Approx. 4 g × 2  |
|   | <b>E5AC-T</b>  | Controller: Approx. 250 g, Adapter: Approx. 4 g × 2  |
| <b>Degree of protection</b>   |  | Front panel: IP66, Rear case: IP20, Terminals: IP00  |
| <b>Memory protection</b>  |  | Non-volatile memory (number of writes: 1,000,000 times)  |
| <b>Setup Tool</b>   |  | CX-Thermo version 4.61 or higher   |
| <b>Setup Tool port</b>  |  | E5EC-T/E5AC-T top panel: An E58-CIFQ2 USB-Serial Conversion Cable is used to connect to a USB port on the computer.*5<br>E5EC-T/E5AC-T front panel: An E58-CIFQ2 USB-Serial Conversion Cable and E58-CIFQ2-E Conversion Cable are used together to connect to a USB port on the computer.*5                                    |
| <b>Standards</b>  | <b>Approved standards</b>  | cULus: UL 61010-1/CSA C22.2 No.61010-1, Korean wireless regulations (Radio law: KC Mark) (Some models only.) *6  |
|   | <b>Conformed standards</b>   | EN 61010-1 (IEC 61010-1)   |
| <b>EMC</b>  | EMI<br>Radiated Interference Electromagnetic Field Strength:<br>Noise Terminal Voltage:<br>EMS:<br>ESD Immunity:<br>Electromagnetic Field Immunity:<br>Burst Noise Immunity:<br>Conducted Disturbance Immunity:<br>Surge Immunity:<br>Voltage Dip/Interrupting Immunity: | EN 61326-1 *7<br>EN 55011 Group 1, class A<br>EN 55011 Group 1, class A<br>EN 61326-1 *7<br>EN 61000-4-2<br>EN 61000-4-3<br>EN 61000-4-4<br>EN 61000-4-6<br>EN 61000-4-5<br>EN 61000-4-11  |

\*1. The indication accuracy of K thermocouples in the -200 to 1300°C range, T and N thermocouples at a temperature of -100°C max., and U and L thermocouples at any temperatures is ±2°C ±1 digit max. The indication accuracy of the B thermocouple at a temperature of 400°C max. is not specified. The indication accuracy of B thermocouples at a temperature of 400 to 800°C is ±3°C max. The indication accuracy of the R and S thermocouples at a temperature of 200°C max. is ±3°C ±1 digit max. The indication accuracy of W thermocouples is (±0.3% of PV or ±3°C, whichever is greater) ±1 digit max. The indication accuracy of PL II thermocouples is (±0.3% of PV or ±2°C, whichever is greater) ±1 digit max.

\*2. Ambient temperature: -10°C to 23°C to 55°C, Voltage range: -15% to 10% of rated voltage

\*3. K thermocouple at -100°C max.: ±10°C max.

\*4. The unit is determined by the setting of the Integral/Derivative Time Unit parameter.

\*5. External communications (RS-485) and USB-serial conversion cable communications can be used at the same time.

\*6. Refer to your OMRON website for the most recent information on applicable models.

\*7. Industrial electromagnetic environment (EN/IEC 61326-1 Table 2)

## Program Control

|                                      |                                    |   |
|--------------------------------------|------------------------------------|---|
| <b>Number of programs (patterns)</b> |                                    | 8   |
| <b>Number of segments (steps)</b>    |                                    | 32  |
| <b>Segment setting method</b>        |                                    | Time setting (Segment set with set point and time.)<br>Slope setting (Segment set with segment type, set point, slope, and time.) |
| <b>Segment times</b>                 |                                    | 0 h 0 min to 99 h 59 min<br>0 min 0 s to 99 min 59 s  |
| <b>Alarm setting</b>                 |                                    | Set separately for each program.  |
| <b>Reset operation</b>               |                                    | Select either stopping control or fixed SP operation.   |
| <b>Startup operation</b>             |                                    | Select continuing, resetting, manual operation, or run mode.  |
| <b>PID sets</b>                      | <b>Number of sets</b>              | 8   |
|                                      | <b>Setting method</b>              | Set separately for each program (automatic PID group selection also supported).   |
| <b>Alarm SP function</b>             |                                    | Select from ramp SP and target SP.  |
| <b>Program status control</b>        | <b>Segment operation</b>           | Advance, segment jump, hold, and wait   |
|                                      | <b>Program operation</b>           | Program repetitions and program links   |
| <b>Wait operation</b>                | <b>Wait method</b>                 | Waiting at segment ends   |
|                                      | <b>Wait width setting</b>          | Same wait width setting for all programs  |
| <b>Time signals</b>                  | <b>Number of outputs</b>           | 2   |
|                                      | <b>Number of ON/OFF Operations</b> | 1 each per output   |
|                                      | <b>Setting method</b>              | Set separately for each program.  |
| <b>Program status output</b>         |                                    | Program end output (pulse width can be set), run output, stage output   |
| <b>Program startup operation</b>     | <b>PV start</b>                    | Select from segment 1 set point, slope-priority PV start  |
|                                      | <b>Standby</b>                     | 0 h 0 min to 99 h 59 min<br>0 day 0 h to 99 day 23h   |
| <b>Operation end operation</b>       |                                    | Select from resetting, continuing control at final set point, and fixed SP control.   |
| <b>Program SP shift</b>              |                                    | Same program SP shift for all programs  |

## USB-Serial Conversion Cable

|                                      |   |
|--------------------------------------|---|
| <b>Applicable OS</b>                 | Windows XP/Vista/7/8/10 *1  |
| <b>Applicable software</b>           | CX-Thermo version 4.61 or higher  |
| <b>Applicable models</b>             | E5□C-T Series, E5□C Series, and E5CB Series   |
| <b>USB interface standard</b>        | Conforms to USB Specification 2.0.  |
| <b>DTE speed</b>                     | 38400 bps   |
| <b>Connector specifications</b>      | Computer: USB (type A plug)<br>Digital Temperature Controller: Special serial connector           |
| <b>Power supply</b>                  | Bus power (Supplied from USB host controller.) *2   |
| <b>Power supply voltage</b>          | 5 VDC   |
| <b>Current consumption</b>           | 450 mA max.   |
| <b>Output voltage</b>                | 4.7±0.2 VDC<br>(Supplied from USB-Serial Conversion Cable to the Digital Temperature Controller.) |
| <b>Output current</b>                | 250 mA max.<br>(Supplied from USB-Serial Conversion Cable to the Digital Temperature Controller.) |
| <b>Ambient operating temperature</b> | 0 to 55°C (with no condensation or icing)   |
| <b>Ambient operating humidity</b>    | 10% to 80%  |
| <b>Storage temperature</b>           | -20 to 60°C (with no condensation or icing)   |
| <b>Storage humidity</b>              | 10% to 80%  |
| <b>Altitude</b>                      | 2,000 m max.  |
| <b>Weight</b>                        | Approx. 120 g   |

Windows is a registered trademark of Microsoft Corporation in the United States and/or other countries.

\*1. CX-Thermo version 4.65 or higher runs on Windows 10.

\*2. Use a high-power port for the USB port.

**Note:** A driver must be installed on the computer. Refer to the *Instruction Manual* included with the Cable for the installation procedure.

## Communications Specifications

|  |   |
|--|---|
| <b>Transmission line connection method</b> | RS-485: Multidrop   |
| <b>Communications</b>                      | RS-485 (two-wire, half duplex)  |
| <b>Synchronization method</b>              | Start-stop synchronization  |
| <b>Protocol</b>                            | CompoWay/F, or Modbus   |
| <b>Baud rate *</b>                         | 9600, 19200, 38400, or 57600 bps  |
| <b>Transmission code</b>                   | ASCII   |
| <b>Data bit length *</b>                   | 7 or 8 bits   |
| <b>Stop bit length *</b>                   | 1 or 2 bits   |
| <b>Error detection</b>                     | Vertical parity (none, even, odd)<br>Block check character (BCC) with CompoWay/F or CRC-16 Modbus |
| <b>Flow control</b>                        | None  |
| <b>Interface</b>                           | RS-485  |
| <b>Retry function</b>                      | None  |
| <b>Communications buffer</b>               | 217 bytes   |
| <b>Communications response wait time</b>   | 0 to 99 ms<br>Default: 20 ms  |

\* The baud rate, data bit length, stop bit length, and vertical parity can be individually set using the Communications Setting Level.

## Communications Functions

|                                     |   |
|-------------------------------------|---|
| <b>Programless communications *</b> | You can use the memory in the PLC to read and write E5□C-T parameters, start and reset operation, etc. The E5□C-T automatically performs communications with PLCs. No communications programming is required.<br>Number of connected Digital Temperature Controllers: 32 max.<br>Applicable PLCs<br>OMRON PLCs<br>CS Series, CJ Series, or CP Series<br>Mitsubishi Electric PLCs<br>MELSEC Q Series, L Series |
|-------------------------------------|---|

|                                 |  |
|---------------------------------|--|
| <b>Component Communications</b> | When Digital Temperature Controllers are connected, set points and RUN/STOP commands can be sent from the Digital Temperature Controller that is set as the master to the Digital Temperature Controllers that are set as slaves. Slope and offsets can be set for the set point.<br>Number of connected Digital Temperature Controllers: 32 max. (including master) |
| <b>Copying *</b>                | When Digital Temperature Controllers are connected, the parameters can be copied from the Digital Temperature Controller that is set as the master to the Digital Temperature Controllers that are set as slaves.  |

MELSEC is a registered trademark of Mitsubishi Electric Corporation.

\* Both the programless communications and the component communications support the copying.

## Current Transformer (Order Separately) Ratings

|                                   |   |
|-----------------------------------|---|
| <b>Dielectric strength</b>        | 1,000 VAC for 1 min                               |
| <b>Vibration resistance</b>       | 50 Hz, 98 m/s <sup>2</sup>                        |
| <b>Weight</b>                     | E54-CT1: Approx. 11.5 g,<br>E54-CT3: Approx. 50 g |
| <b>Accessories (E54-CT3 only)</b> | Armatures (2)<br>Plugs (2)                        |

## Heater Burnout Alarms and SSR Failure Alarms

|  |  |
|--|--|
| <b>CT input (for heater current detection)</b> | Models with detection for single-phase heaters: One input                  |
| <b>Maximum heater current</b>                  | 50 A AC  |
| <b>Input current indication accuracy</b>       | ±5% FS ±1 digit max.   |
| <b>Heater burnout alarm setting range *1</b>   | 0.1 to 49.9 A (in units of 0.1 A)<br>Minimum detection ON time: 100 ms *3  |
| <b>SSR failure alarm setting range *2</b>      | 0.1 to 49.9 A (in units of 0.1 A)<br>Minimum detection OFF time: 100 ms *4 |

\*1. For heater burnout alarms, the heater current will be measured when the control output is ON, and the output will turn ON if the heater current is lower than the set value (i.e., heater burnout detection current value).

\*2. For SSR failure alarms, the heater current will be measured when the control output is OFF, and the output will turn ON if the heater current is higher than the set value (i.e., SSR failure detection current value).

\*3. The value is 30 ms for a control period of 0.1 s or 0.2 s.

\*4. The value is 35 ms for a control period of 0.1 s or 0.2 s.

## Electrical Life Expectancy Curve for Relays (Reference Values)

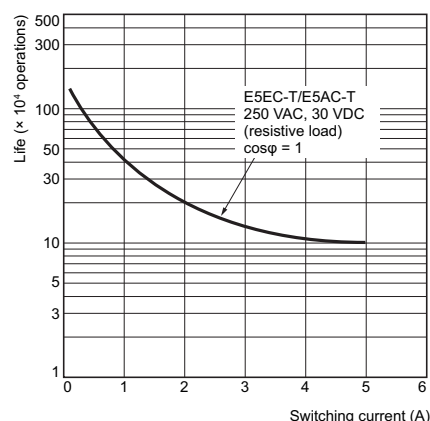

# E5EC-T/E5AC-T

## External Connections

### E5EC-T/E5AC-T

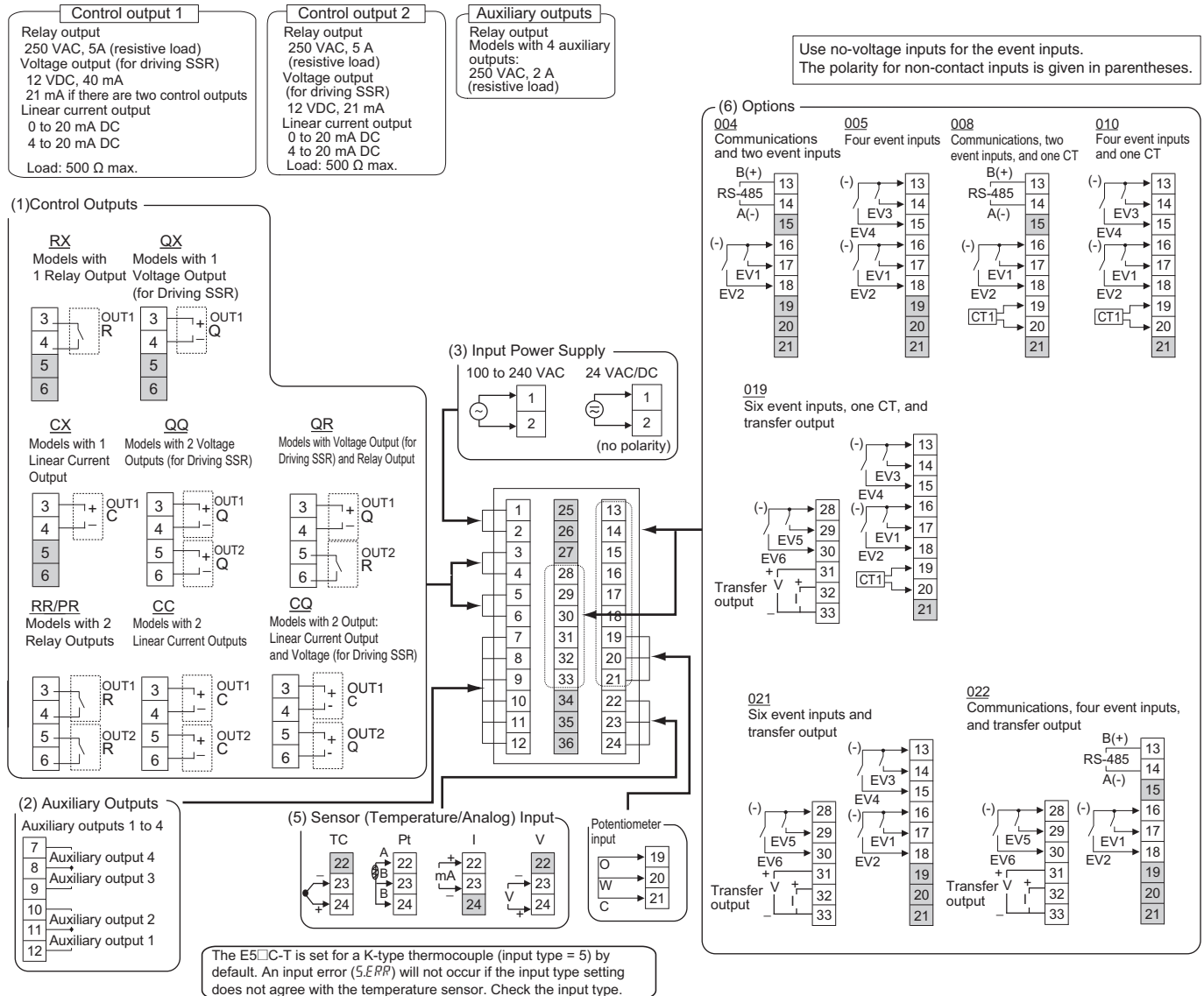
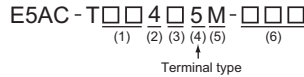
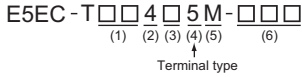

- Note:**
1. The application of the terminals depends on the model.
  2. Do not wire the terminals that are shown with a gray background.
  3. When complying with EMC standards, the cable that connects the sensor must be 30 m or less. If the cable length exceeds 30 m, compliance with EMC standards will not be possible.
  4. Connect M3 crimped terminals.

## Isolation/Insulation Block Diagrams

### Models with 4 Auxiliary Outputs

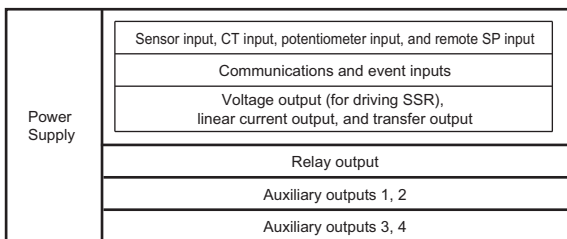

□ : Reinforced insulation  
 □ : Functional isolation

**Note:** Auxiliary outputs 1 to 2 and 3 to 4 are not insulated.

# Nomenclature

## E5EC-T

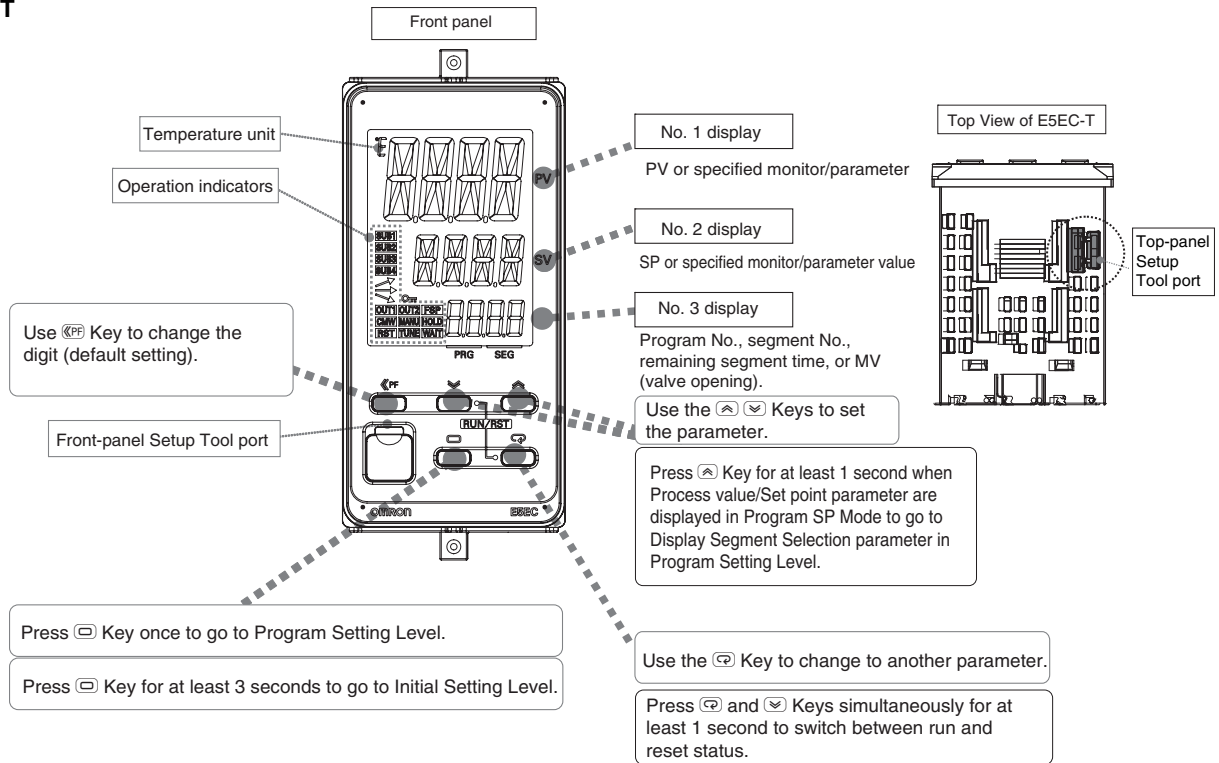

## E5AC-T

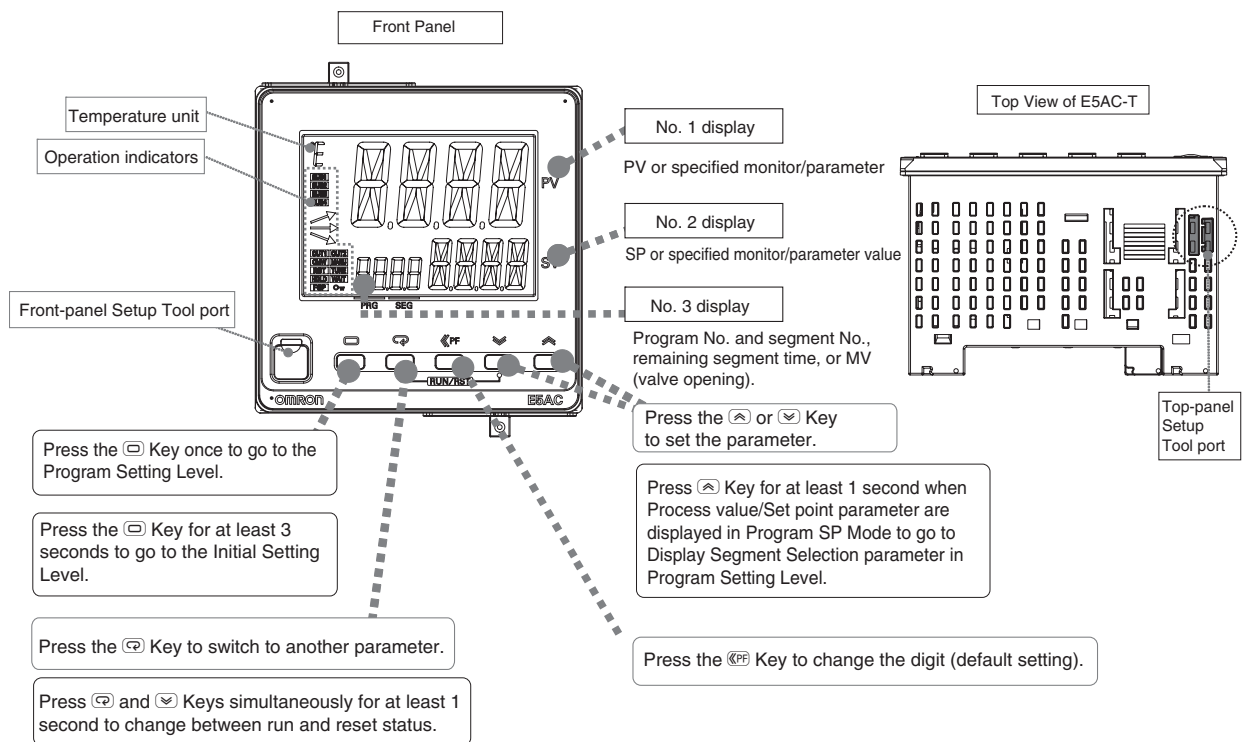

### Controllers

#### E5EC-T

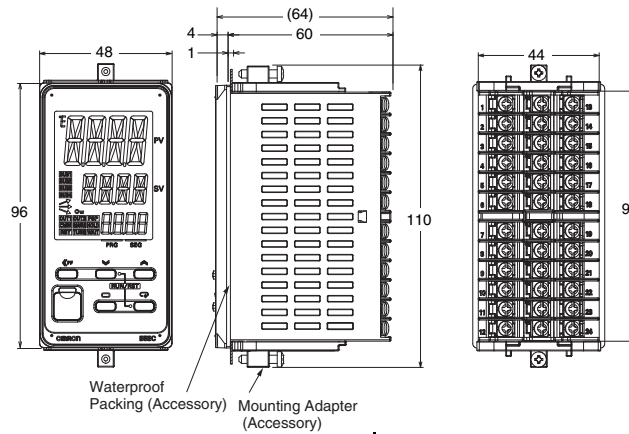

- Setup Tool ports are provided as standard feature. Use these ports to connect a computer to the Digital Temperature Controller. The E58-CIFQ2 USB-Serial Conversion Cable is required to connect to the port on the top panel. The E58-CIFQ2 USB-Serial Conversion Cable and E58-CIFQ2-E Communications Conversion Cable are required to connect to the port on the front panel. (You cannot leave either port connected constantly during operation.)

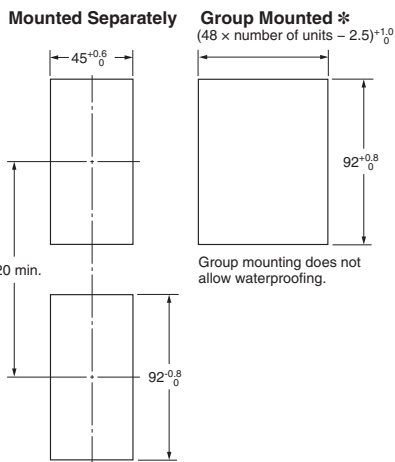

- Recommended panel thickness is 1 to 8 mm.
- Group mounting is not possible in the vertical direction. (Maintain the specified mounting space between Controllers.)
- To mount the Controller so that it is waterproof, insert the waterproof packing onto the Controller.
- When two or more Controllers are mounted, make sure that the surrounding temperature does not exceed the allowable operating temperature specified in the specifications.

\* Selections for Control Outputs 1 and 2: QQ, QR, RR, CC, PR, or CQ  
 If you also specify 019, 021, 022 for the option selection and use group mounting, the ambient temperature must be 45°C or less. Maintain the following spacing when more than one Digital Controller is installed at an ambient temperature of 55°C.

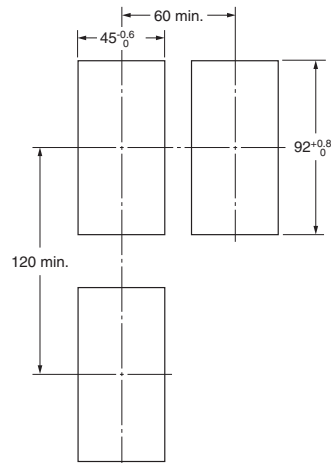



E5AC-T

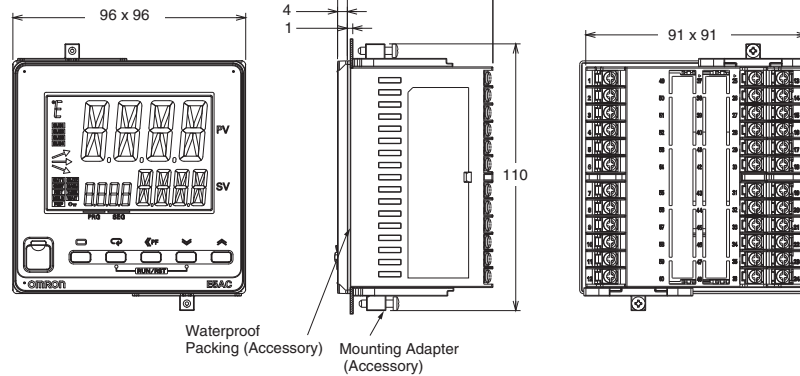

- Setup Tool ports are provided as standard feature. Use these ports to connect a computer to the Digital Temperature Controller. The E58-CIFQ2 USB-Serial Conversion Cable is required to connect to the port on the top panel. The E58-CIFQ2 USB-Serial Conversion Cable and E58-CIFQ2-E Communications Conversion Cable are required to connect to the port on the front panel. (You cannot leave either port connected constantly during operation.)

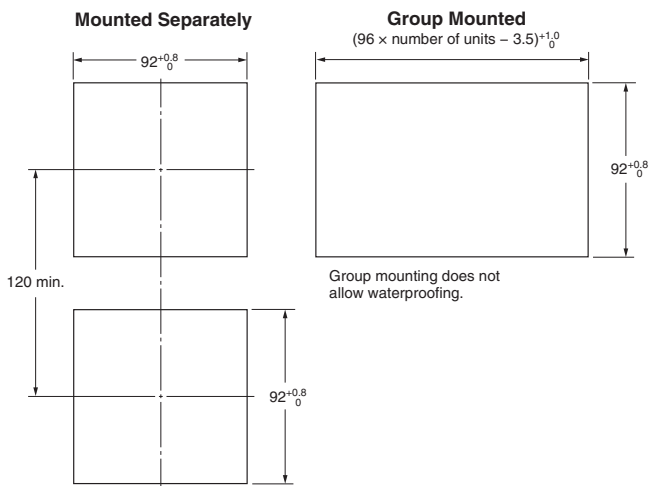

- Recommended panel thickness is 1 to 8 mm.
- Group mounting is not possible in the vertical direction. (Maintain the specified mounting space between Controllers.)
- To mount the Controller so that it is waterproof, insert the waterproof packing onto the Controller.
- When two or more Controllers are mounted, make sure that the surrounding temperature does not exceed the allowable operating temperature specified in the specifications.

## Accessories (Order Separately)

### USB-Serial Conversion Cable

E58-CIFQ2

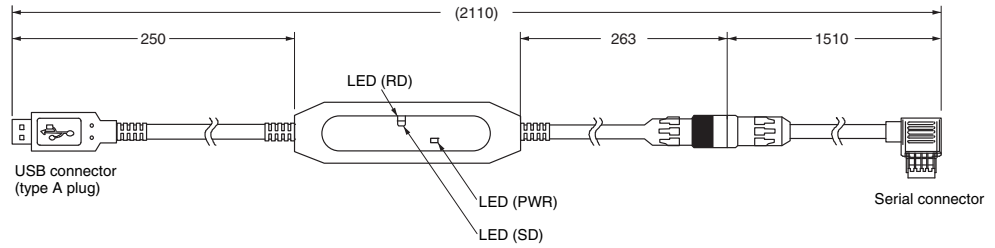

### Conversion Cable

E58-CIFQ2-E

Conversion Cable

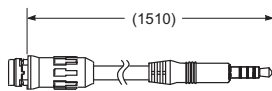

Connecting to the E58-CIFQ2 USB-Serial Conversion Cable

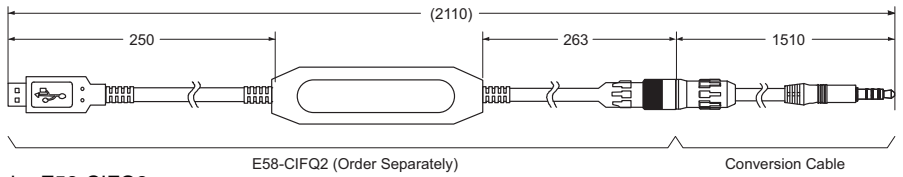

**Note:** Always use this product together with the E58-CIFQ2.

### Terminal Covers

E53-COV24 (Three Covers provided.)

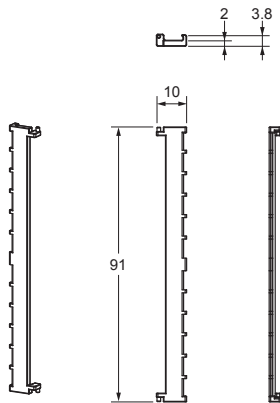

### Waterproof Packing

Y92S-P9 (for DIN 48 × 96)

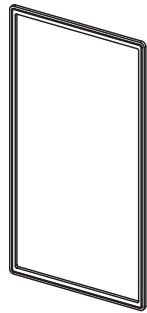

Y92S-P10 (for DIN 96 × 96)

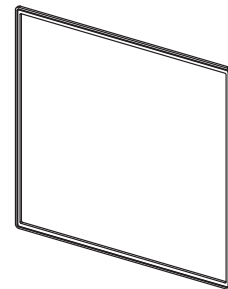

The Waterproof Packing is provided with the Temperature Controller.  
Order the Waterproof Packing separately if it becomes lost or damaged.  
The degree of protection when the Waterproof Packing is used is IP66.  
Also, keep the Port Cover on the front-panel Setup Tool port of the E5EC-T/E5AC-T securely closed.  
To maintain an IP66 degree of protection, the Waterproof Packing and the Port Cover for the front-panel Setup Tool port must be periodically replaced because they may deteriorate, shrink, or harden depending on the operating environment.  
The replacement period will vary with the operating environment.  
Check the required period in the actual application.  
Use 3 years or sooner as a guideline.

### Setup Tool Port Cover for top panel

Y92S-P7

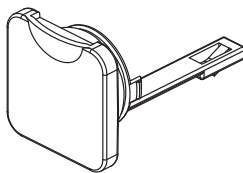

Order this Port Cover separately if the Port Cover on the front-panel Setup Tool port is lost or damaged. The Waterproof Packing must be periodically replaced because it may deteriorate, shrink, or harden depending on the operating environment.

### Mounting Adapter

Y92F-51 (Two Adapters provided.)

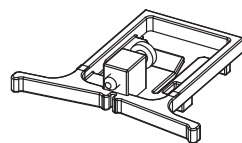

One pair is provided with the Controller.  
Order this Adapter separately if it becomes lost or damaged.

**Watertight Cover**  
Y92A-49N (48 × 96)

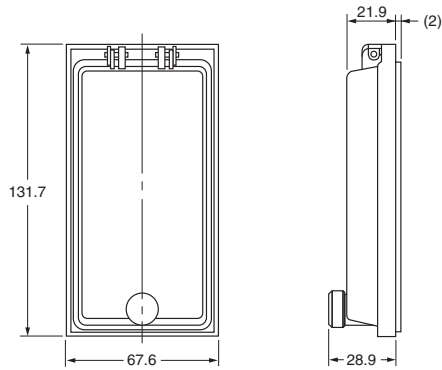

**Watertight Cover**  
Y92A-96N (96 × 96)

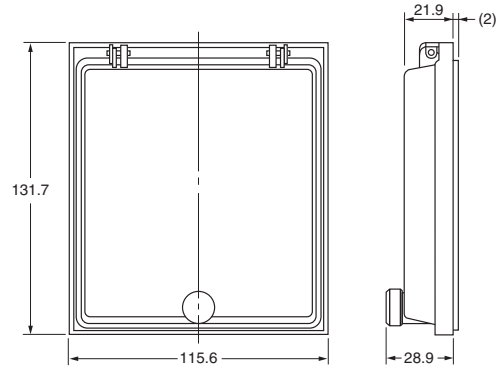

**Current Transformers**

**E54-CT1**

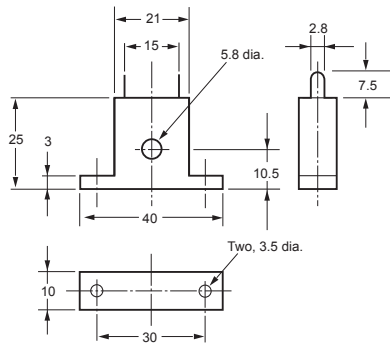
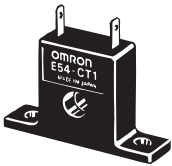

**Thru-current (Io) vs. Output Voltage (Eo)**  
**(Reference Values)**  
**E54-CT1**

Maximum continuous heater current: 50 A (50/60 Hz)  
Number of windings: 400±2  
Winding resistance: 18±2 Ω

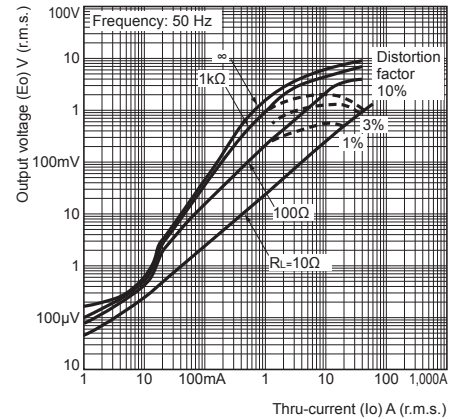

**E54-CT3**

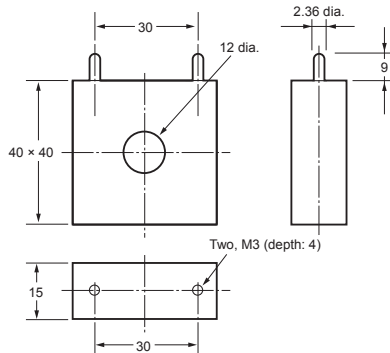

**Thru-current (Io) vs. Output Voltage (Eo)**  
**(Reference Values)**  
**E54-CT3**

Maximum continuous heater current: 120 A (50/60 Hz)  
(Maximum continuous heater current for an OMRON Digital Temperature Controller is 50 A.)  
Number of windings: 400±2  
Winding resistance: 8±0.8 Ω

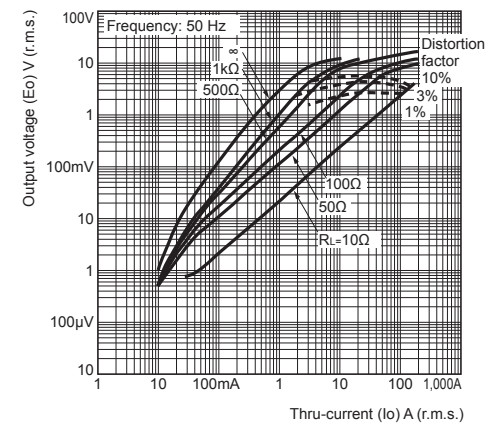

**E54-CT3 Accessories**

• **Armature**

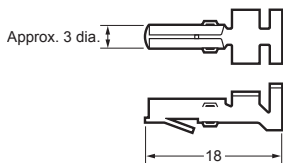

• **Plug**

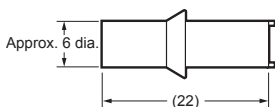

**Connection Example**

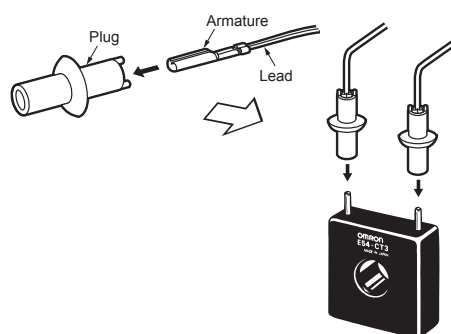

# Operation

## Setting Levels Diagram

### E5□C

This diagram shows all of the setting levels. To move to the advanced function setting level and calibration level, you must enter passwords. Some parameters are not displayed depending on the protect level setting and the conditions of use.

Control stops when you move from the operation level to the initial setting level.

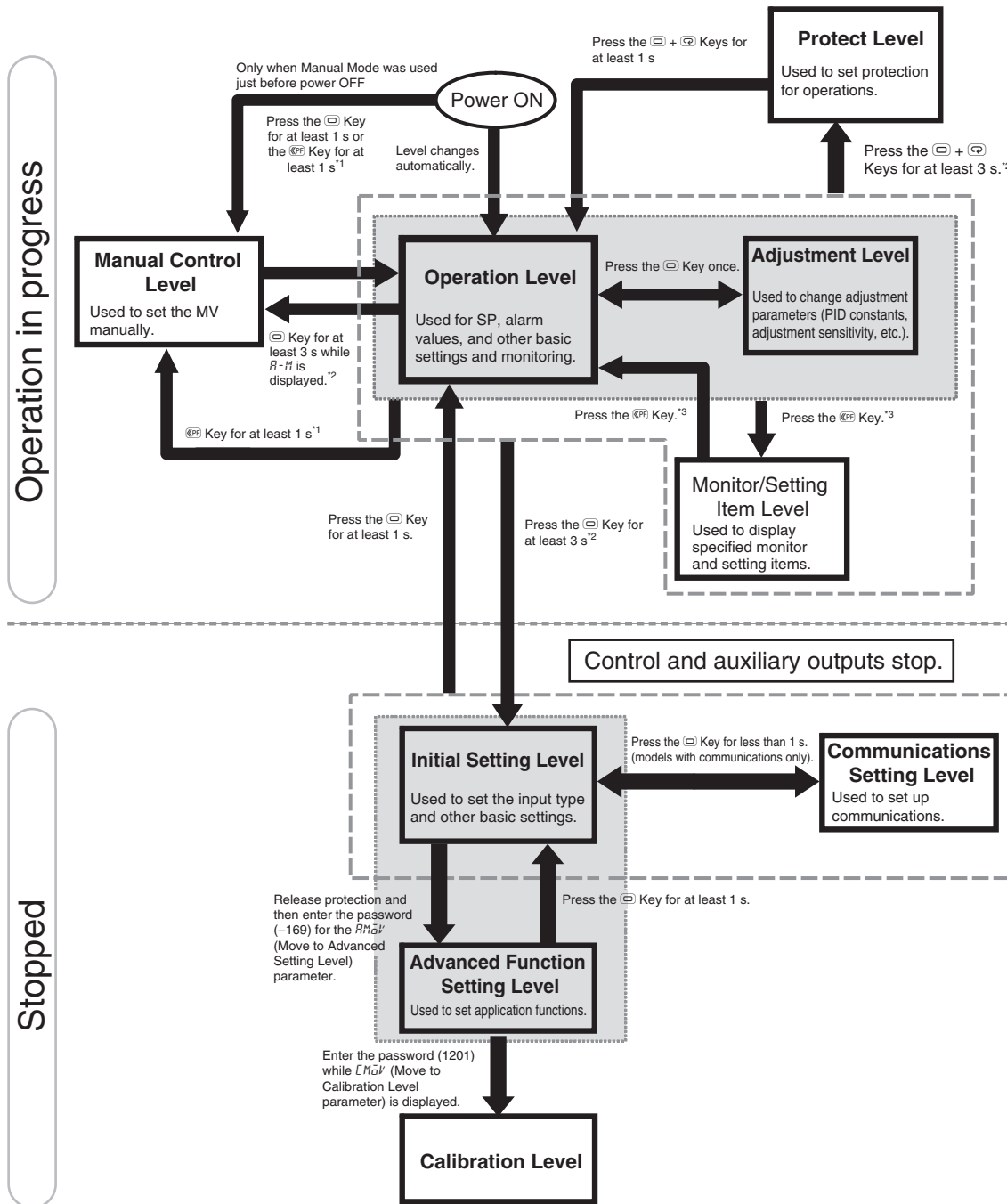

\*1. Set the PF Setting parameter to R-M (Auto/Manual).  
 \*2. The No. 1 display will flash when the keys are pressed for 1 s or longer.  
 \*3. Set the PF Setting parameter to PF dP (monitor/setting items).

**E5□C-T**

This diagram shows all of the setting levels. To move to the advanced function setting level and calibration level, you must enter passwords. Some parameters are not displayed depending on the protect level setting and the conditions of use.

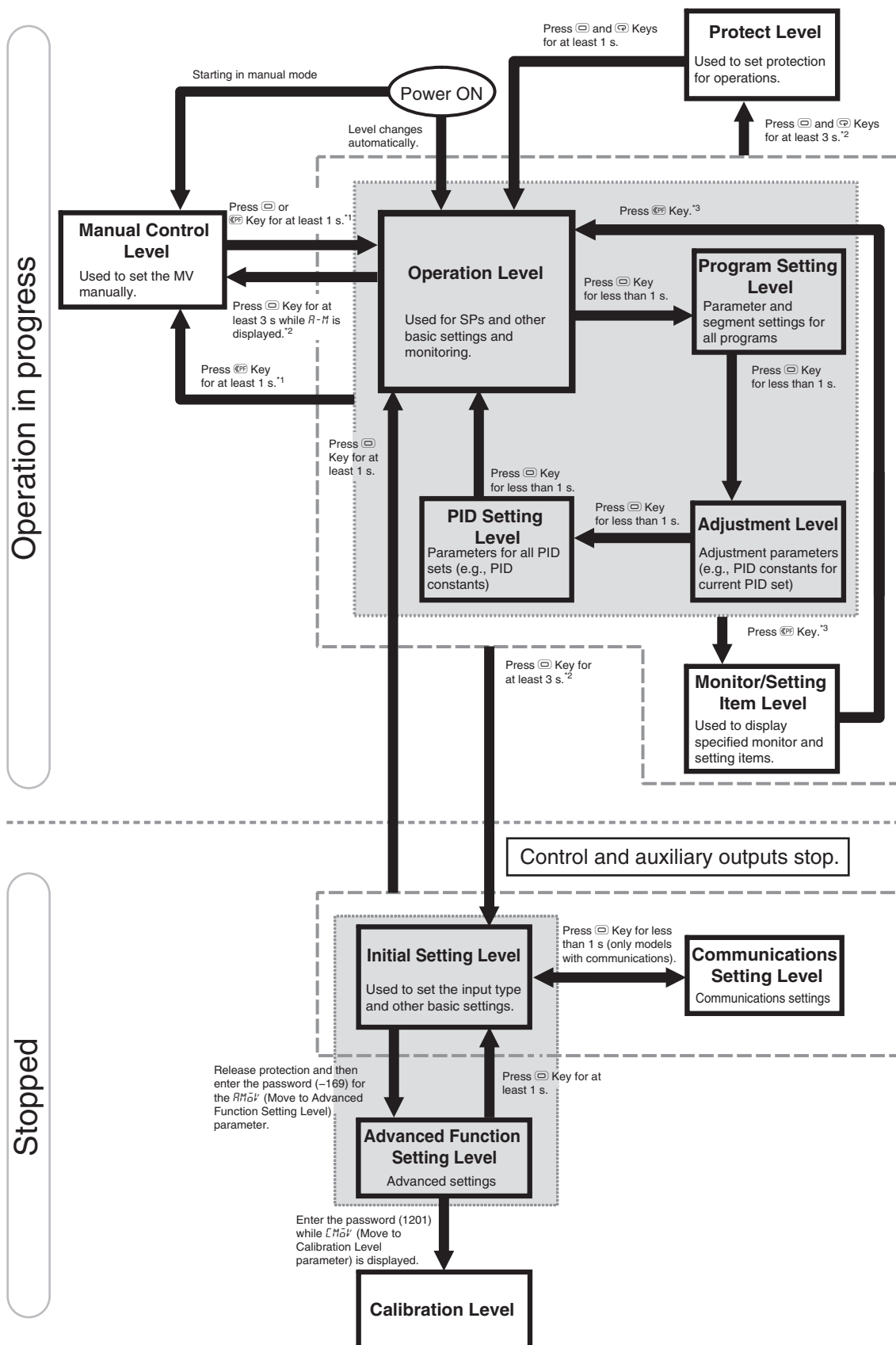

\*1. Set the PF Setting parameter to *R-M* (Auto/Manual).  
 \*2. The No. 1 display will flash when the keys are pressed for 1 s or longer.  
 \*3. Set the PF Setting parameter to *PFdP* (monitor/setting items).



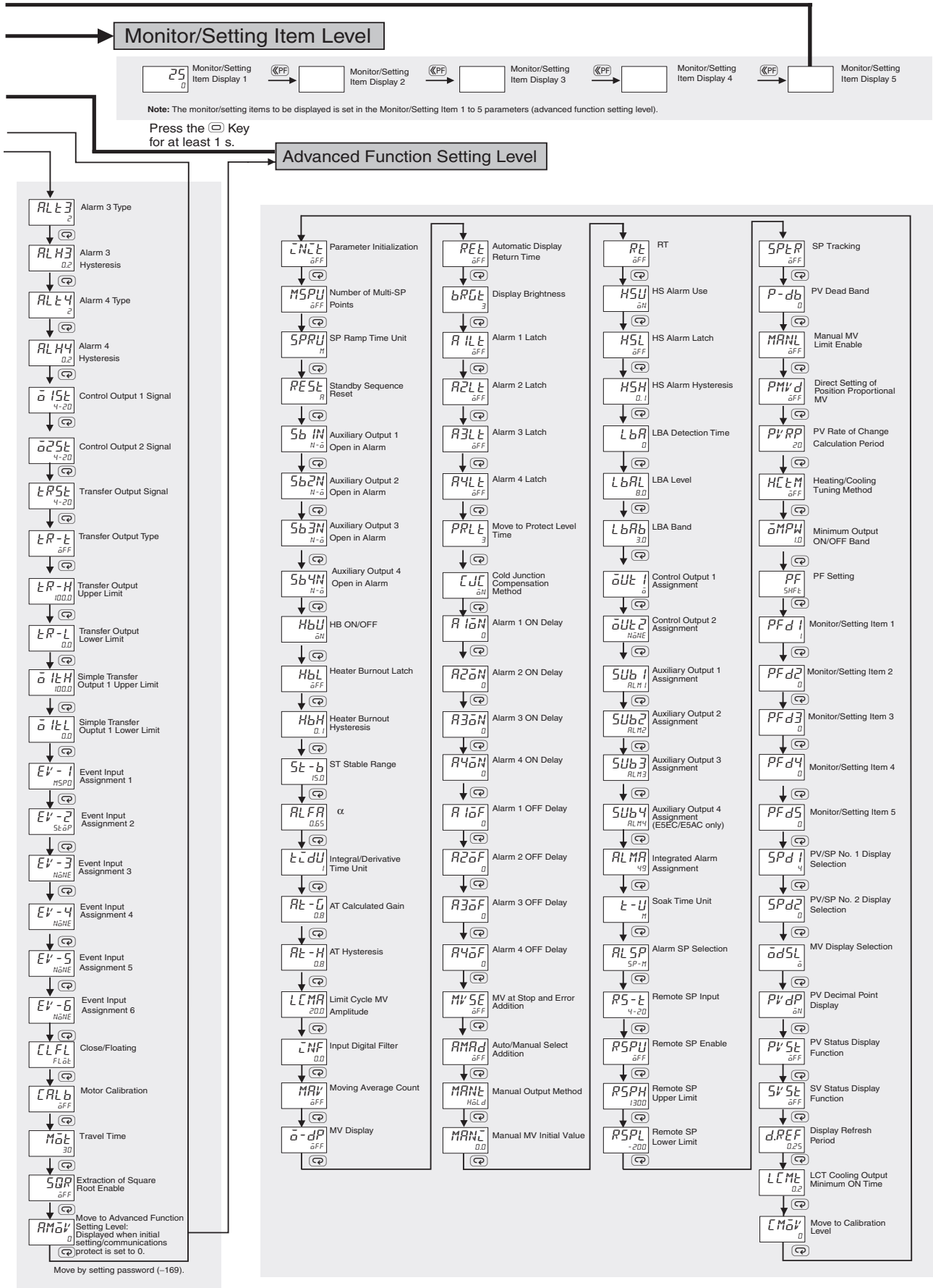

E5□C-T

Some parameters may not be displayed depending on the model and other settings.

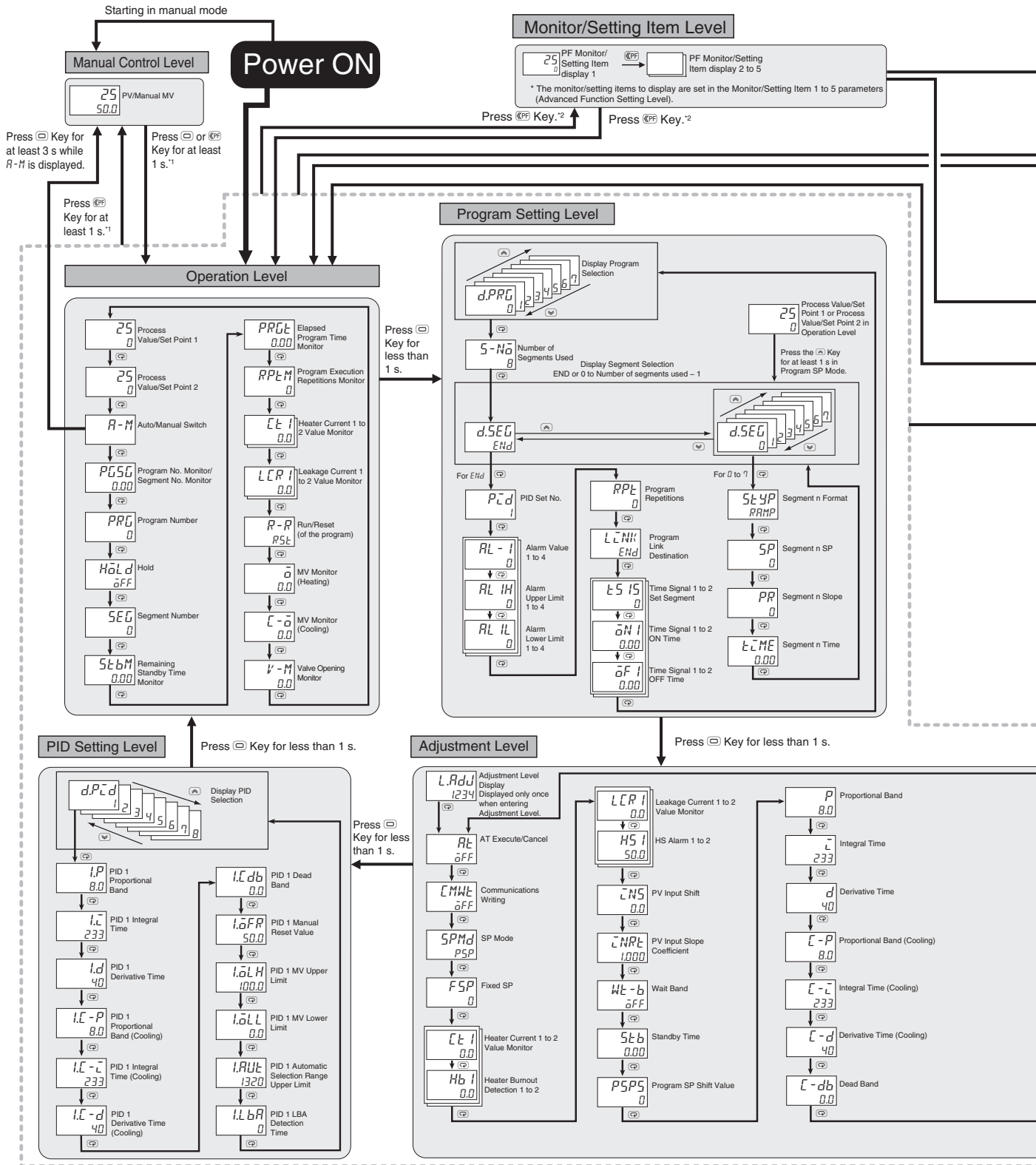



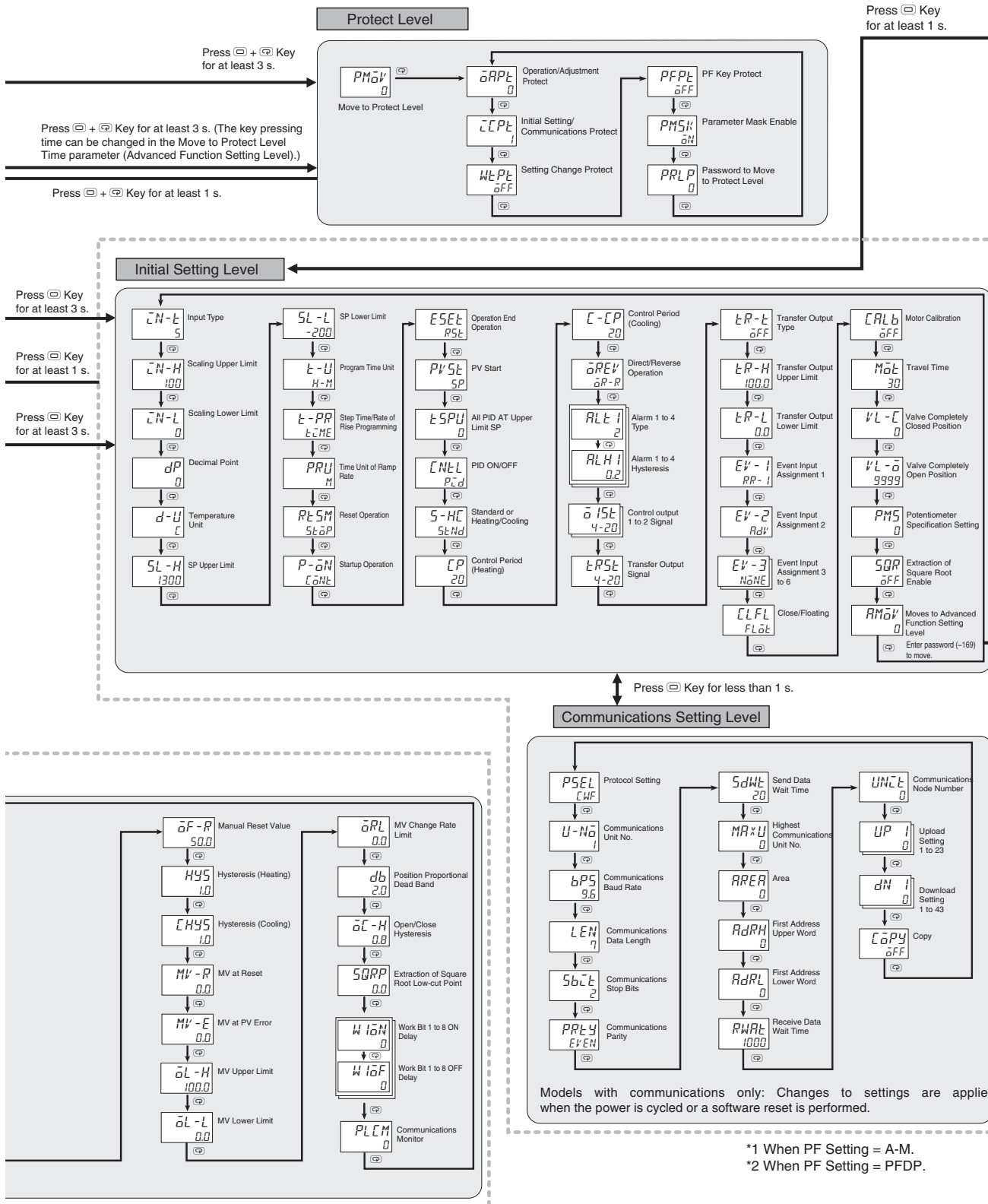

Advanced Function Setting Level

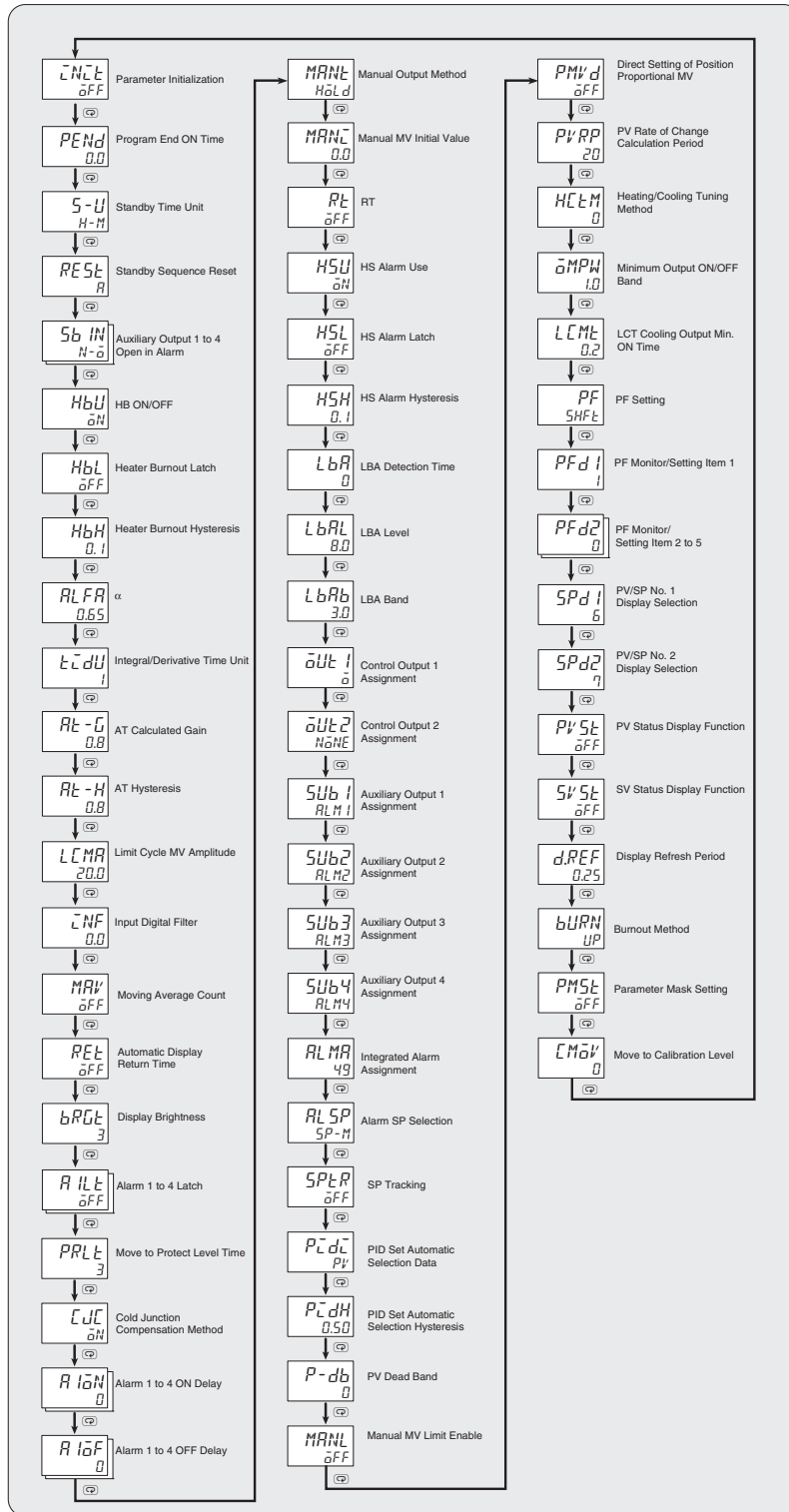

## Error Displays (Troubleshooting)

When an error occurs, the No. 1 display or No. 2 display shows the error code.  
Take necessary measure according to the error code, referring the following table.

| Display                    | Name  | Meaning   | Action  | Operation  |
|----------------------------|---|---|---|--|
| E.ERR                      | Input error   | <p>The input value exceeded the control range.*<br/>The input type is not set correctly.<br/>The sensor is disconnected or short-circuited.<br/>The sensor is not wired correctly.<br/>The sensor is not wired.</p> <p>* Control Range<br/>Temperature resistance thermometer or thermocouple input:<br/>SP Lower Limit - 20°C to SP Upper Limit + 20°C<br/>(SP Lower Limit - 40°F to SP Upper Limit + 40°F)<br/>ESIB input:<br/>Same as specified input range.<br/>Analog input:<br/>Scaling range -5% to 105%</p> | <p>Check the wiring for input to be sure it is wired correctly, not broken, and not shorted. Also check the input type.<br/>If there are no problems in the wiring or input type settings, cycle the power supply.<br/>If the display remains the same, replace the Digital Temperature Controller.<br/>If the display is restored to normal, then the probable cause is external noise affecting the control system. Check for external noise.</p> <p><b>Note:</b> For a temperature resistance thermometer, the input is considered disconnected if the A, B, or B' line is broken.</p> | <p>After the error occurs and it is displayed, the alarm output will operate as if the upper limit was exceeded. It will also operate as if transfer output exceeded the upper limit. If an input error is assigned to a control output or auxiliary output, the output will turn ON when the input error occurs.<br/>The error message will appear in the display for the PV.</p> <p><b>Note:</b> 1. The heating and cooling control outputs will turn OFF.<br/>2. When the manual MV, MV at stop, MV at reset, or MV at error is set, the control output is determined by the set value.</p> |
| cccc                       | Display range exceeded  | Below -1,999  | -   | Control continues and operation is normal.<br>The value will appear in the display for the PV.<br>Refer to the E5□C Digital Temperature Controllers User's Manual (Cat. No. H174) or the E5□C-T Digital Temperature Controllers Programmable Type User's Manual (Cat. No. H185) for information on the controllable range.   |
| cccc                       |   | Above 9,999   |   |  |
| E333                       | A/D converter error   | There is an error in the internal circuits.   | <p>After checking the input error, turn the power OFF then back ON again. If the display remains the same, the controller must be repaired.<br/>If the display is restored to normal, then a probable cause can be external noise affecting the control system. Check for external noise.</p>   | The control outputs, auxiliary outputs, and transfer outputs turn OFF. (A current output will be approx. 0 mA and a linear voltage output will be approx. 0V.)   |
| E111                       | Memory error  | There is an error in the internal memory operation.   | <p>First, cycle the power supply. If the display remains the same, the controller must be repaired.<br/>If the display is restored to normal, then a probable cause can be external noise affecting the control system. Check for external noise.</p>   | The control outputs, auxiliary outputs, and transfer outputs turn OFF. (A current output will be approx. 0 mA and a linear voltage output will be approx. 0V.)   |
| FFFF                       | Overcurrent   | This error is displayed when the peak current exceeds 55.0 A.   | -   | Control continues and operation is normal.<br>The error message will appear for the following displays.<br>Heater Current Value 1 Monitor<br>Heater Current Value 2 Monitor<br>Leakage Current Value 1 Monitor<br>Leakage Current Value 2 Monitor  |
| E11<br>E12<br>LER1<br>LER2 | HB or HS alarm  | If there is a HB or HS alarm, the No. 1 display will flash in the relevant setting level.   | -   | The No. 1 display for the following parameter flashes in Operation Level or Adjustment Level.<br>Heater Current Value 1 Monitor<br>Heater Current Value 2 Monitor<br>Leakage Current Value 1 Monitor<br>Leakage Current Value 2 Monitor<br>However, control continues and operation is normal.   |
| ----                       | Potentiometer Input Error (Position-proportional Models Only) | <p>"----" will be displayed for the Valve Opening Monitor parameter if any of the following error occurs.</p> <ul style="list-style-type: none"> <li>Motor calibration has not been performed.</li> <li>The wiring of the potentiometer is incorrect or broken.</li> <li>The potentiometer input value is incorrect (e.g., the input is out of range or the potentiometer has failed).</li> </ul>   | Check for the above errors.   | Close control: The control output is OFF or the value that is set for the MV at PV Error parameter is output.<br>Floating control: Operation will be normal.   |





## Safety Precautions

Be sure to read the precautions for all E5□C/E5□C-T models in the website at: <http://www.ia.omron.com/>.

### Warning Indications

|  |   |
|--|---|
|  <b>CAUTION</b> | Indicates a potentially hazardous situation which, if not avoided, may result in minor or moderate injury or in property damage.              |
| <b>Precautions for Safe Use</b>  | Supplementary comments on what to do or avoid doing, to use the product safely.   |
| <b>Precautions for Correct Use</b>   | Supplementary comments on what to do or avoid doing, to prevent failure to operate, malfunction or undesirable effect on product performance. |

### Meaning of Product Safety Symbols

|   |   |
|---|---|
|    | Used to warn of the risk of electric shock under specific conditions.   |
|    | Used for general prohibitions for which there is no specific symbol.  |
|    | Used to indicate prohibition when there is a risk of minor injury from electrical shock or other source if the product is disassembled.   |
|   | Used for general CAUTION, WARNING, or DANGER precautions for which there is no specified symbol. (This symbol is also used as the alerting symbol, but shall not be used in this meaning on the product.) |
|  | Used for general mandatory action precautions for which there is no specified symbol.   |

### CAUTION

Do not touch the terminals while power is being supplied. Doing so may occasionally result in minor injury due to electric shock. 

Electric shock may occur. Do not touch any cables or connectors with wet hands. 

Minor electric shock, fire, or malfunction may occasionally occur. Do not allow any metal, conductors, chips from mounting work, or water to enter the interior of the Digital Controller, the Setting Tool port, or between the pins on the Setting Tool cable connector. 

If you do not use the Setting Tool port on the front panel, close the cover securely so that the above foreign matter does not enter.

Do not use the Digital Temperature Controller where subject to flammable or explosive gas. Otherwise, minor injury from explosion may occasionally occur. 

Not doing so may occasionally result in fire. Do not allow dirt or other foreign objects to enter the Setup Tool port or ports, or between the pins on the connectors on the Setup Tool cable. 

Minor electric shock or fire may occasionally occur. Do not use any cables that are damaged. 

Never disassemble, modify, or repair the product or touch any of the internal parts. Minor electric shock, fire, or malfunction may occasionally occur. 

**CAUTION - Risk of Fire and Electric Shock**  
 1. This product is UL listed \*1 as Open Type Process Control Equipment. It must be mounted in an enclosure that does not allow fire to escape externally.  
 2. More than one disconnect switch may be required to de-energize the equipment before servicing the product.  
 3. Signal inputs are SELV, limited energy. \*2  
 4. Caution: To reduce the risk of fire or electric shock, do not interconnect the outputs of different Class 2 circuits. \*3 

If the output relays are used past their life expectancy, contact fusing or burning may occasionally occur. Always consider the application conditions and use the output relays within their rated load and electrical life expectancy. The life expectancy of output relays varies considerably with the output load and switching conditions. 

Even if you replace only the Main Unit of the E5DC, check the condition of the Terminal Unit. If corroded terminals are used, contact failure in the terminals may cause the temperature inside the Digital Temperature Controller to increase, possibly resulting in fire.   
 If the terminals are corroded, replace the Terminal Unit as well.

Tighten the terminal screws to the rated torque of between 0.43 and 0.58 N·m. \*4  
 Loose screws may occasionally result in fire. 

Set the parameters of the product so that they are suitable for the system being controlled. If they are not suitable, unexpected operation may occasionally result in property damage or accidents. 

A malfunction in the product may occasionally make control operations impossible or prevent alarm outputs, resulting in property damage.   
 To maintain safety in the event of malfunction of the product, take appropriate safety measures, such as installing a monitoring device on a separate line.

\*1. E5CC, E5EC, E5AC, and E5DC Digital Temperature Controllers that were shipped through November 2013 are UL recognized.  
 \*2. An SELV (separated extra-low voltage) system is one with a power supply that has double or reinforced insulation between the primary and the secondary circuits and has an output voltage of 30 V r.m.s. max. and 42.4 V peak max. or 60 VDC max.  
 \*3. A class 2 circuit is one tested and certified by UL as having the current and voltage of the secondary output restricted to specific levels.  
 \*4. The specified torque is 0.5 N·m for the E5CC-U.

## Precautions for Safe Use

Be sure to observe the following precautions to prevent malfunction or adverse affects on the performance or functionality of the product. Not doing so may occasionally result in faulty operation. Do not handle the Digital Temperature Controller in ways that exceed the ratings.

- This product is specifically designed for indoor use only. Do not use this product in the following places:
  - Places directly subject to heat radiated from heating equipment.
  - Places subject to splashing liquid or oil atmosphere.
  - Places subject to direct sunlight.
  - Places subject to dust or corrosive gas (in particular, sulfide gas and ammonia gas).
  - Places subject to intense temperature change.
  - Places subject to icing and condensation.
  - Places subject to vibration and large shocks.
- Use and store the product within the rated ambient temperature and humidity. Gang-mounting two or more Digital Temperature Controllers, or mounting Digital Temperature Controllers above each other may cause heat to build up inside the Digital Temperature Controllers, which will shorten their service life. In such a case, use forced cooling by fans or other means of air ventilation to cool down the Digital Temperature Controllers.
- To allow heat to escape, do not block the area around the Digital Temperature Controller. Do not block the ventilation holes on the Digital Temperature Controller.
- Be sure to wire properly with correct signal name and polarity of terminals.
- Use copper stranded or solid wires to connect bare wires.

### Recommended Wire

| Model   | Wire Size  | Wire Stripping length   |
|---|--|-------------------------|
| E5CC/E5EC/<br>E5AC/E5DC/<br>E5□C-T/E5GC<br>(Controllers with<br>Screw Terminal<br>Blocks) | AWG24 to AWG18<br>(0.21 to 0.82mm <sup>2</sup> )           | 6 to 8 mm               |
| E5GC<br>(Controllers with<br>Screwless Clamp<br>Terminal Blocks)                          |  | 8 to 12 mm              |
| E5CC-U<br>(Plug-in model)   | AWG24 to 14<br>(0.21 to 2.08mm <sup>2</sup> )              | 5 to 6 mm               |
| E5□C-B<br>(Controllers with<br>Push-In Plus<br>Terminal Blocks)                           | 0.25 to 1.5mm <sup>2</sup><br>Equivalent to<br>AWG24 to 16 | Ferrules not used: 8 mm |

Use the specified size of crimped terminals to wire the E5CC, E5EC, E5AC, E5DC, and E5GC (models with screw terminal blocks) and the E5□C-T and E5CC-U (plug-in models).

### Recommended Crimped Terminal Size

| Model   | Wire Size                |
|---|--------------------------|
| E5CC/E5EC/E5AC/E5DC/E5□C-T/<br>E5GC (Controllers with Screw<br>Terminal Blocks) | M3, Width: 5.8 mm max.   |
| E5CC-U (Plug-in model)  | M3.5, Width: 7.2 mm max. |

For the E5□C-B(Push-In Plus model), connect only one wire to each terminal.

For other models, up to two wires of same size and type, or two crimp terminals, can be inserted into a single terminal.

When connecting two wires to one terminal on an E5GC Digital Temperature Controller with a screwless clamp terminal blocks, use two crimped ferrules with a diameter of 0.8 to 1.4 mm and an exposed conductor length of 8 to 12 mm. \*

\*The E5GC Digital Temperature Controller with screwless clamp terminal blocks underwent UL testing with one braided wire connected.

- Do not wire the terminals that are not used.
- Use a commercial power supply for the power supply voltage input to a Digital Temperature Controller with AC input specifications. Do not use the output from an inverter as the power supply. Depending on the output characteristics of the inverter, temperature increases in the Digital Temperature Controller may cause smoke or fire damage even if the inverter has a specified output frequency of 50/60 Hz.
- To avoid inductive noise, keep the wiring for the product's terminal block away from power cables carry high voltages or large currents. Also, do not wire power lines together with or parallel to product wiring. Using shielded cables and using separate conduits or ducts is recommended. Attach a surge suppressor or noise filter to peripheral devices that generate noise (in particular, motors, transformers, solenoids, magnetic coils, or other equipment that have an inductance component). When a noise filter is used at the power supply, first check the voltage or current, and attach the noise filter as close as possible to the product. Allow as much space as possible between the product and devices that generate powerful high frequencies (high-frequency welders, high-frequency sewing machines, etc.) or surge.
- Use this product within the rated load and power supply.
- Make sure that the rated voltage is attained within two seconds of turning ON the power using a switch or relay contact. If the voltage is applied gradually, the power may not be reset or output malfunctions may occur.
- Make sure that the Digital Temperature Controller has 30 minutes or more to warm up after turning ON the power before starting actual control operations to ensure the correct temperature display.
- When executing self-tuning with E5□C, turn ON power to the load (e.g., heater) at the same time as or before supplying power to the product. If power is turned ON to the product before turning ON power to the load, self-tuning will not be performed properly and optimum control will not be achieved.
- A switch or circuit breaker must be provided close to the product. The switch or circuit breaker must be within easy reach of the operator, and must be marked as a disconnecting means for this unit.
- Use a soft and dry cloth to clean the product carefully. Do not use organic solvent, such as paint thinner, benzene or alcohol to clean the product.
- Design the system (e.g., control panel) considering the 2 seconds of delay that the product's output to be set after power ON.
- The output may turn OFF when you move to the initial setting level. Take this into consideration when performing control operations.
- The number of non-volatile memory write operations is limited. Therefore, use RAM write mode when frequently overwriting data during communications or other operations.
- Always touch a grounded piece of metal before touching the Digital Temperature Controller to discharge static electricity from your body.
- Use suitable tools when taking the Digital Temperature Controller apart for disposal. Sharp parts inside the Digital Temperature Controller may cause injury.
- For compliance with Lloyd's standards, the E5CC, E5CC-B, E5EC-B, E5CC-U, E5EC, E5AC, and E5DC must be installed under the conditions that are specified in *Shipping Standards*.
- For the Digital Temperature Controller with two Setup Tool ports (E5EC/E5EC-B/E5AC/E5DC/E5GC), do not connect cables to both ports at the same time. The Digital Temperature Controller may be damaged or may malfunction.
- Do not place heavy object on the Conversion Cable, bend the cable past its natural bending radius, or pull on the cable with undue force. The Digital Temperature Controller may be damaged.

23. Do not disconnect the Communications Conversion Cable or the USB-Serial Conversion Cable while communications are in progress. Damage or malfunction may occur.
24. Do not touch the external power supply terminals or other metal parts on the Digital Temperature Controller.
25. Do not exceed the communications distance that is given in the specifications and use the specified communications cable. Refer to the E5□C Digital Temperature Controllers User's Manual (Cat. No. H174) for information on the communications distances and cables for the E5□C.  
For details on the E5□C-T, refer to the *E5□C-T Digital Temperature Controllers Programmable Type User's Manual* (Cat. No. H185).
26. Do not bend the communications cables past their natural bending radius. Do not pull on the communications cables.
27. Do not turn the power supply to the Digital Temperature Controller ON or OFF while the USB-Serial Conversion Cable is connected. The Digital Temperature Controller may malfunction.
28. Make sure that the indicators on the USB-Serial Conversion Cable are operating properly. Depending on the application conditions, deterioration in the connectors and cable may be accelerated, and normal communications may become impossible. Perform periodic inspection and replacement.
29. Connectors may be damaged if they are inserted with excessive force. When connecting a connector, always make sure that it is oriented correctly. Do not force the connector if it does not connect smoothly.
30. Noise may enter on the USB-Serial Conversion Cable, possibly causing equipment malfunctions. Do not leave the USB-Serial Conversion Cable connected constantly to the equipment.
31. For the E5DC, when you attach the Main Unit to the Terminal Unit, make sure that the hooks on the Main Unit are securely inserted into the Terminal Unit.
32. For the E5CC-U, when you attach the Main Unit to the socket, make sure that the hooks on the socket are securely inserted into the Main Unit.
33. Install the DIN Track vertically to the ground.
34. For the E5DC, always turn OFF the power supply before connecting the Main Unit to or disconnecting the Main Unit from the Terminal Unit, and never touch nor apply shock to the terminals or electronic components. When connecting or disconnecting the Main Unit, do not allow the electronic components to touch the case.
35. Observe the following precautions when you remove the terminal block or pulling out the interior of the product of the E5GC.
  - Always follow the instructions provided in the E5□C Digital Temperature Controllers User's Manual (Cat. No. H174).
  - Turn OFF the power supply before you start and never touch nor apply shock to the terminals or electric components. When you insert the interior body of the Digital Temperature Controller, do not allow the electronic components to touch the case.
  - Check for any corrosion on the terminals.
  - When you insert the interior body into the rear case, confirm that the hooks on the top and bottom are securely engaged with the case.
36. Observe the following precautions when you wire the E5□C-B.
  - Always follow the wiring instructions provided in *Wiring Precautions for E5□C-B (Controllers with Push-In Plus Terminal Blocks)* on page 116.
  - Do not wire anything to the release holes.
  - Do not tilt or twist a flat-blade screwdriver while it is inserted into a release hole on the terminal block. The terminal block may be damaged.
  - Insert a flat-blade screwdriver into the release holes at an angle. The terminal block may be damaged if you insert the screwdriver straight in.
  - Do not allow the flat-blade screwdriver to fall out while it is inserted into a release hole.
  - Do not bend a wire past its natural bending radius or pull on it with excessive force. Doing so may cause the wire to break.
  - Do not use crossover wiring except for the input power supply and communications.

### Shipping Standards

The E5CC, E5CC-B, E5CC-U, E5EC, E5EC-B, E5AC, and E5DC comply with Lloyd's standards. When applying the standards, the following installation requirements must be met in the application. Also insert the Waterproof Packing on the backside of the front panel.

## Application Conditions

### Installation Location

The E5CC, E5CC-B, E5CC-U, E5EC, E5EC-B, E5AC, and E5DC comply with installation category ENV1 and ENV2 of Lloyd's standards. Therefore, they must be installed in a location equipped with air conditioning. They cannot be used on the bridge or decks, or in a location subject to strong vibration.

### Precautions for Correct Use

### Service Life

1. Use the product within the following temperature and humidity ranges:  
 Temperature: -10 to 55°C (with no icing or condensation)  
 Humidity: 25% to 85%  
 If the product is installed inside a control board, the ambient temperature must be kept to under 55°C, including the temperature around the product.
2. The service life of electronic devices like Digital Temperature Controllers is determined not only by the number of times the relay is switched but also by the service life of internal electronic components. Component service life is affected by the ambient temperature: the higher the temperature, the shorter the service life and, the lower the temperature, the longer the service life. Therefore, the service life can be extended by lowering the temperature of the Digital Temperature Controller.
3. When two or more Digital Temperature Controllers are mounted horizontally close to each other or vertically next to one another, the internal temperature will increase due to heat radiated by the Digital Temperature Controllers and the service life will decrease. In such a case, use forced cooling by fans or other means of air ventilation to cool down the Digital Temperature Controllers. When providing forced cooling, however, be careful not to cool down the terminals sections alone to avoid measurement errors.

## Measurement Accuracy

1. When extending or connecting the thermocouple lead wire, be sure to use compensating wires that match the thermocouple types.
2. When extending or connecting the lead wire of the platinum resistance thermometer, be sure to use wires that have low resistance and keep the resistance of the three lead wires the same.
3. Mount the product so that it is horizontally level.
4. If the measurement accuracy is low, check to see if input shift has been set correctly.

## Waterproofing (Not applicable to the E5CC-U/E5DC.)

The degree of protection is as shown below. Sections without any specification on their degree of protection or those with IP□□ are not waterproof.

Front panel: IP66, Rear case: IP20, Terminal section: IP00

When waterproofing is required, insert the Waterproof Packing on the backside of the front panel. Keep the Port Cover on the front-panel Setup Tool port of the E5EC/E5EC-B/E5AC/E5EC-T/E5AC-T securely closed. The degree of protection when the Waterproof Packing is used is IP66. To maintain an IP66 degree of protection, the Waterproof Packing and the Port Cover for the front-panel Setup Tool must be periodically replaced because they may deteriorate, shrink, or harden depending on the operating environment. The replacement period will vary with the operating environment. Check the required period in the actual application. Use 3 years or sooner as a guideline.

## Operating Precautions

1. When using self-tuning, turn ON power for the load (e.g., heater) at the same time as or before supplying power to the Digital Temperature Controller. If power is turned ON for the Digital Temperature Controller before turning ON power for the load, self-tuning will not be performed properly and optimum control will not be achieved.  
When starting operation after the Digital Temperature Controller has warmed up, turn OFF the power and then turn it ON again at the same time as turning ON power for the load. (Instead of turning the Digital Temperature Controller OFF and ON again, switching from STOP mode to RUN mode can also be used.)
2. Avoid using the Digital Temperature Controller in places near a radio, television set, or wireless installing. These devices can cause radio disturbances which adversely affect the performance of the Controller.

## Others

1. Do not Connect or disconnect the Conversion Cable connector repeatedly over a short period of time.  
The computer may malfunction.
2. After connecting the Conversion Cable to the computer, check the COM port number before starting communications. The computer requires time to recognize the cable connection. This delay does not indicate failure.
3. Do not connect the Conversion Cable through a USB hub. Doing so may damage the Conversion Cable.
4. Do not use an extension cable to extend the Conversion Cable length when connecting to the computer. Doing so may damage the Conversion Cable.

## Mounting

### Mounting to a Panel E5GC

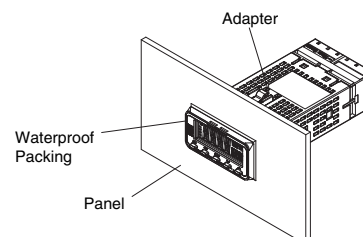

1. For waterproof mounting, waterproof packing must be installed on the Digital Temperature Controller. Waterproofing is not possible when group mounting several Digital Temperature Controllers.
2. Insert the E5GC into the mounting hole in the panel.
3. Use two Mounting Adapters, either on the top and bottom or on the right and left.
4. Push the Adapters from the terminals up to the panel, and temporarily fasten the E5GC.
5. Tighten the two fastening screws on the Adapter. Alternately tighten the two screws little by little to maintain a balance. Tighten the screws to a torque of 0.29 to 0.39 N·m.

### E5CC/E5CC-B/E5CC-U/E5CC-T

- E5CC/E5CC-T

There are two models of Terminal Covers that you can use with the E5CC/E5CC-T.

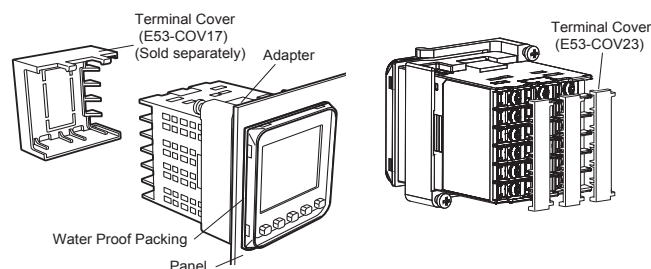

- E5CC-U

For the Wiring Socket for the E5CC-U, purchase the P2CF-11 or P3GA-11 separately.

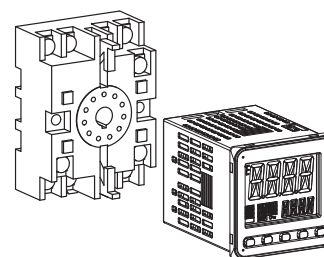

1. For waterproof mounting, waterproof packing must be installed on the Digital Temperature Controller. Waterproofing is not possible when group mounting several Digital Temperature Controllers. The E5CC-U cannot be waterproofed even if the Waterproof Packing is inserted.
2. Insert the E5CC/E5CC-B/E5CC-U/E5CC-T into the mounting hole in the panel.
3. Push the adapter from the terminals up to the panel, and temporarily fasten the E5CC/E5CC-B/E5CC-U/E5CC-T.
4. Tighten the two fastening screws on the adapter. Alternately tighten the two screws little by little to maintain a balance. Tighten the screws to a torque of 0.29 to 0.39 N·m.

## E5EC/E5EC-B/E5AC/E5EC-T/E5AC-T

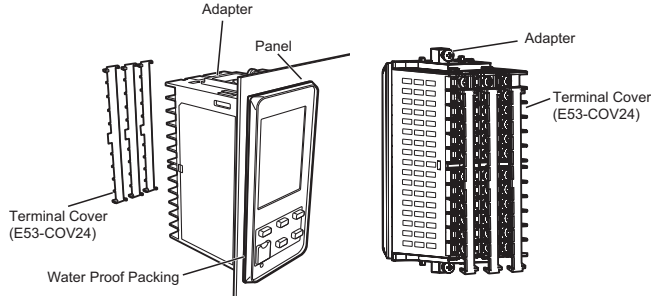

1. For waterproof mounting, waterproof packing must be installed on the Digital Temperature Controller. Waterproofing is not possible when group mounting several Digital Temperature Controllers.
2. Insert the E5EC/E5EC-B/E5AC/E5EC-T/E5AC-T into the mounting hole in the panel.
3. Push the adapter from the terminals up to the panel, and temporarily fasten the E5EC/E5EC-B/E5AC/E5EC-T/E5AC-T.
4. Tighten the two fastening screws on the adapter. Alternately tighten the two screws little by little to maintain a balance. Tighten the screws to a torque of 0.29 to 0.39 N·m.

## E5DC

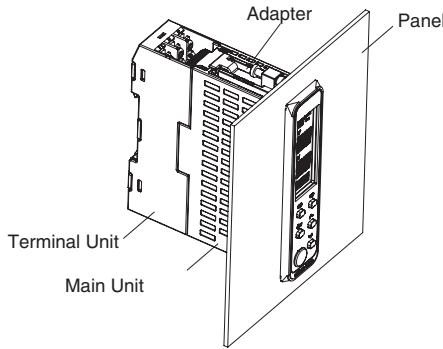

1. Insert the E5DC into the mounting hole in the panel. (Attach the Terminal Unit after you insert the Main Unit.)
2. Push the Adapter from the Terminal Unit up to the panel, and temporarily fasten the E5DC.
3. Tighten the two fastening screws on the Adapter. Alternately tighten the two screws little by little to maintain a balance. Tighten the screws to a torque of 0.29 to 0.39 N·m.

## Mounting to and Removing from DIN Track

### E5DC

- **Mounting a Unit**  
Pull down the DIN Track hook on the Terminal Unit and catch the top hook on the DIN Track. Press the Unit onto the DIN Track until the DIN Track hooks are locked in place.

2. Catch the top hook on the DIN Track.

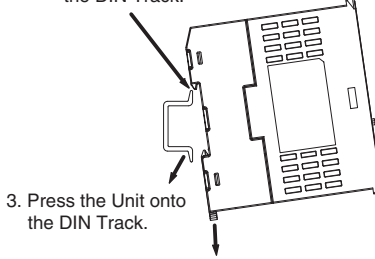

1. Pull down the hook.

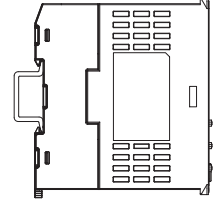

4. Make sure that the hooks are locked in place.

- **Removing a Unit**  
Pull down on the DIN Track Hook with a flat-blade screwdriver and lift up the Unit.

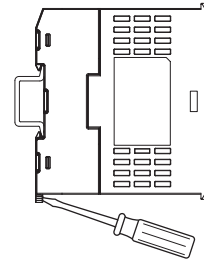

## Removing the Main Unit

Press in the two hooks on the Main Unit and remove the Main Unit from the Terminal Unit.

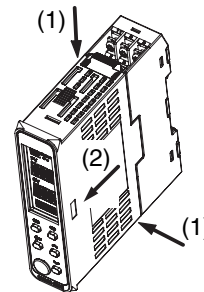

## End Plate Installation

Make sure to attach PFP-M End Plates to the ends of the Units.

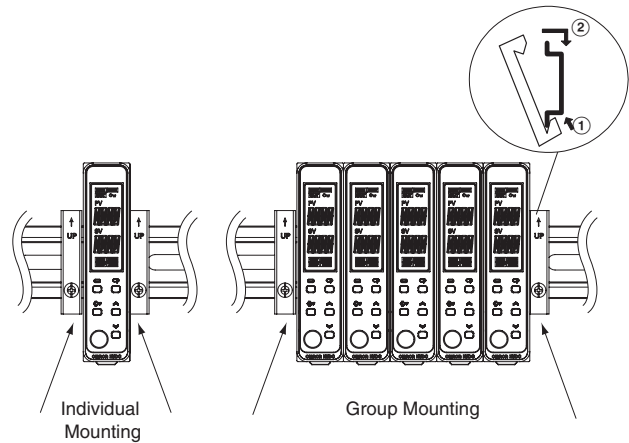



### Mounting the DIN Track

Attach the DIN Track to the inside of the control panel with screws to at least three locations.

- DIN Track (sold separately)  
 PFP-50N (50 cm) and PFP-100N (100 cm)

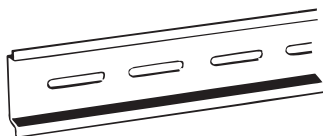

Install the DIN Track vertically to the ground.

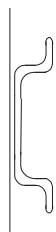

Vertical: OK



Horizontal: NG

### Mounting the Terminal Cover E5CC/E5CC-T

Slightly bend the E53-COV23 Terminal Cover to attach it to the terminal block as shown in the following diagram. The Terminal Cover cannot be attached in the opposite direction. E53-COV17 Terminal Cover can be also attached.

Make sure that the "UP" mark is facing up, and then attach the E53-COV17 Terminal Cover to the holes on the top and bottom of the Digital Temperature Controller.

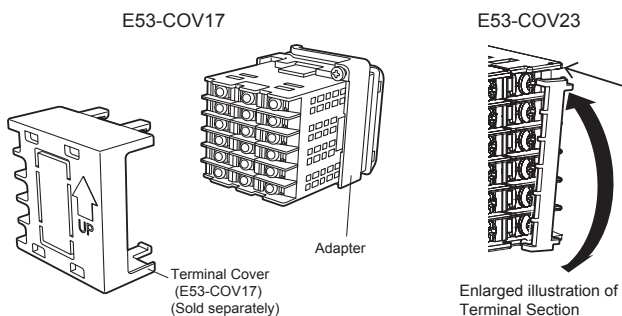

### E5EC/E5AC/E5EC-T/E5AC-T

Slightly bend the E53-COV24 Terminal Cover to attach it to the terminal block as shown in the following diagram. The Terminal Cover cannot be attached in the opposite direction.

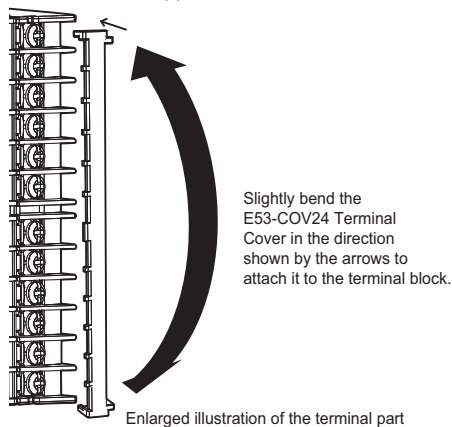

### Attaching the End Cover E5DC

1. Install the E5DC in a panel.

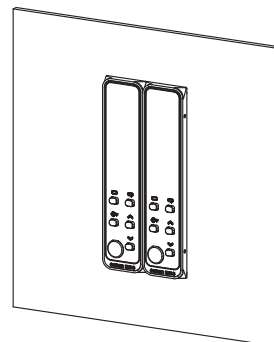

2. Peel off the release paper from the double-sided tape on the End Cover.

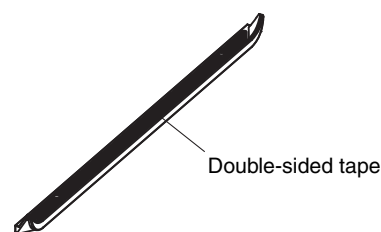

3. Align the tabs on the End Cover with the depressions on the E5DC and attach the End Cover.

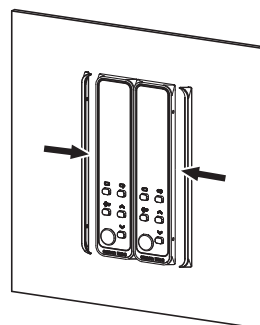
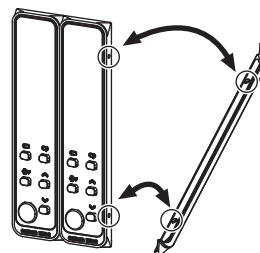

4. Secure the End Cover so that the double-sided tape is firmly attached.

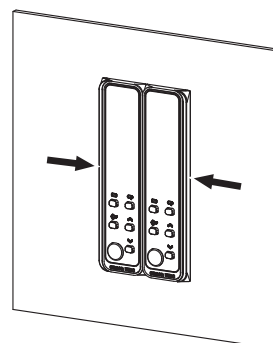

## Removing the Digital Temperature Controller from the case E5GC

You can use the Y92F-55 Draw-out Jig to remove the interior body of the Digital Temperature Controller from the case to perform maintenance without removing the terminal wiring. This is possible only for the E5GC. Check the specifications of the case and Digital Temperature Controller before removing the Digital Temperature Controller from the case.

### 1. Draw out the interior body from the rear case.

- Slowly insert the Draw-out Jig into the Draw-out Jig insertion holes laterally until it clicks into place. (There is a hole at both the top and bottom.) (If you attempt to draw out the interior body of the Digital Controller when only one hook is engaged, the Digital Controller may be damaged.)

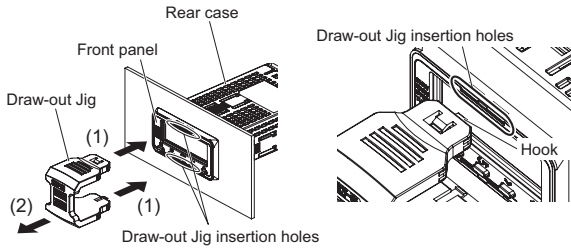

- Pull out the Draw-out Jig together with the front panel. Do not pull with excessive force. Slowly pull out the Digital Controller laterally. (If you pull the interior body out at an angle, the Digital Controller may be damaged.)
- After the interior body is free from the rear case, support the interior body with one hand and draw it out slowly in a horizontal direction.

### 2. Insert the new interior body into the rear case.

- When inserting the interior body back into the rear case, make sure the PCBs are parallel to each other, mount the sealing rubber, and press the interior body toward the rear case and into position, making sure that the sealing rubber does not move.
- When you press the Digital Controller into position, press down on the rear case hooks so that the case hooks securely lock in place. (There are rear case hooks at both the top and bottom of the rear case.) If the Digital Controller is not correctly mounted into the rear case, the rear case may not be waterproof. When inserting the Digital Controller, do not allow the electronic components to touch the rear case.

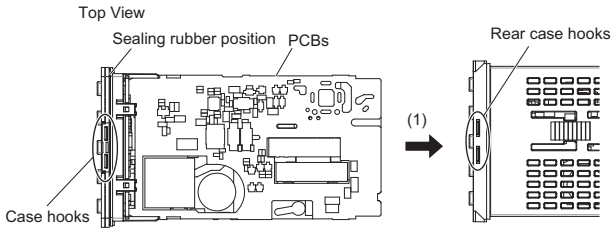

\* Make sure that the top and bottom PCBs are parallel to each other and insert them into the rear case.

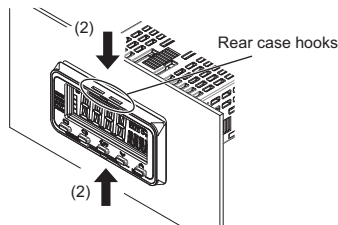

## Removing the draw-out jig when only one hook is caught in the draw-out jig insertion hole

- Pull the Draw-out Jig slowly in the direction shown in the figure. (This step is the same even if the other hook is caught.)
  - Confirm that the Draw-out jig is free of the Draw-out jig insertion hole.
  - If the interior body separates from the rear case, slowly press the interior body into the rear case in a horizontal direction.
- If you do not follow the procedures above, the Digital Controller may be damaged.

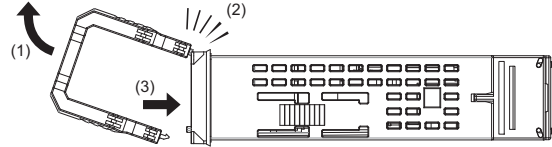

## Precautions when Wiring

- Separate input leads and power lines in order to prevent external noise.
- Use crimp terminals when wiring the screw terminal blocks.
- Use the suitable wiring material and crimp tools for crimp terminals.
- Tighten the terminal screws to a torque of 0.43 to 0.58 N·m. The specified torque is 0.5 N·m for the E5CC-U.

## E5CC/E5EC/E5AC/E5DC/E5□C-T/E5GC (Controllers with Screw Terminal Blocks) and E5CC-U (Plug-in model)

### Wire Size

Use the wire sizes and stripping lengths given in the following table.

| Model  | Wire Size                                      | Stripping length                    |
|--|--|-------------------------------------|
| E5CC/E5EC/E5AC/E5DC/E5GC (Controllers with Screw Terminal Blocks) / E5□C-T | AWG24 to AWG18 (0.21 to 0.82 mm <sup>2</sup> ) | 6 to 8 mm (without crimp terminals) |
| E5CC-U   | AWG24 to AWG14 (0.21 to 2.08 mm <sup>2</sup> ) | 5 to 6 mm (without crimp terminals) |

- If you use crimp terminals, use the stripping length that is recommended by the manufacturer of the crimp terminals.
- To reduce the affects of noise, use shielded twisted-pair cable for the signal lines.

### Crimp Terminal

For the E5CC/E5EC/E5AC/E5DC/E5GC (Controllers with Screw Terminal Blocks) or E5□C-T, use the following types of crimp terminals for M3 screws.



For the E5CC-U, use the following types of crimp terminals for M3.5 screws.



- If you use crimp terminals for the E5DC, use crimp terminals with insulation sleeves. If you use a bare crimp terminal with no insulation, the terminal may short with the terminal above or below it. If you use bare crimp terminals, cover the crimped sections with insulating marking tubes. Secure the marking tubes so that they do not move.

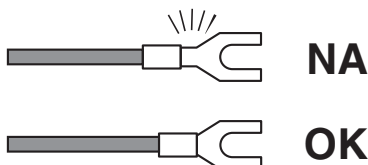

Although you can connect two crimp terminals with insulation sleeves to one terminal, you cannot do so if the diameter of the insulation sleeves is too large.

Recommended Crimp Terminals with Insulation Sleeves for the E5DC

| Manufacturer    | Model number         |
|-----------------|----------------------|
| J.S.T. Mfg. Co. | V1.25-B3A<br>V0.5-3A |

### E5GC (Controllers with Screwless Clamp Terminal Blocks)

#### 1. Connection Method for Screwless Clamp Terminals

The same method is used to connect stranded wires, solid wires, and ferrules.

#### Part Names of the Terminal Block

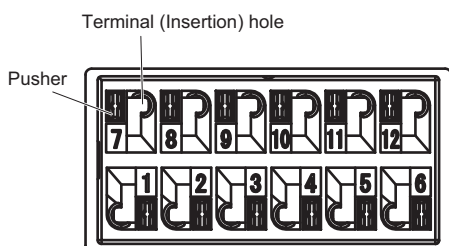

#### Connection Method

1. Press the pusher with a flat-blade screwdriver.
2. With the screwdriver still pressing the pusher, insert the wire into the terminal (Insertion) hole.
3. Remove the flat-blade screwdriver from the pusher.

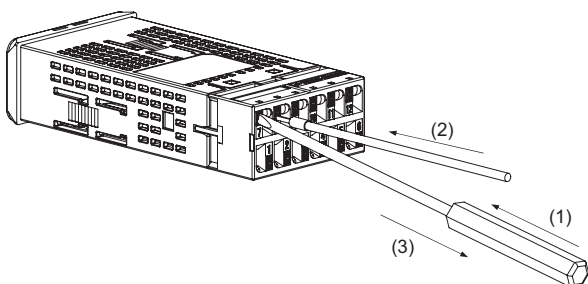

#### Checking Connections

- After insertion, pull gently on the wire to make sure that it will not come out (i.e., to confirm that it is held by the terminal block).

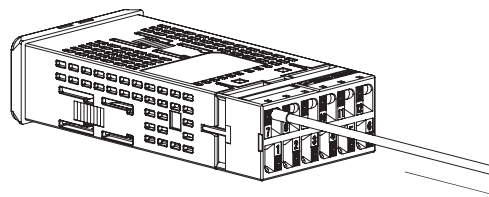

#### 2. Removal Method for Screwless Clamp Terminals

The same method is used to remove stranded wires, solid wires, and ferrules.

1. Press the pusher with a flat-blade screwdriver.
2. With the screwdriver still pressing the pusher, pull the wire out of the terminal (Insertion) hole.
3. Remove the flat-blade screwdriver from the pusher.

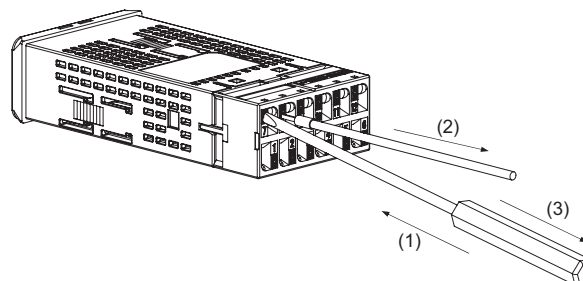

#### 3. Recommended Wire Size and Ferrules

##### Wire Size

Use the wire sizes and stripping lengths given in the following table.

| Wire Size   | Stripping length |
|---|------------------|
| AWG24 to AWG18<br>(0.21 to 0.82 mm <sup>2</sup> ) | 8 to 12 mm       |

##### Ferrules

Ferrules must be 0.8 to 1.4 mm in diameter.

The exposed conductor inserted into the terminal must be 8 to 12 mm in length.

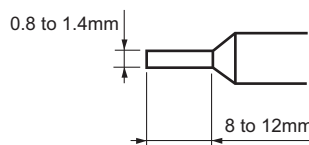

#### Recommended ferrules

| Manufacturer name                  |                 | Model number    |
|------------------------------------|-----------------|-----------------|
| Altech Corp.                       |                 | 2623.0          |
| Daido Solderless Terminal Mfg. Co. |                 | AVA-0.5         |
| J.S.T. Mfg. Co.                    |                 | TUB-0.5         |
| Nichifu Co., Ltd.                  | Single (1 wire) | TGNTC-1.25-9T   |
|                                    |                 | TGVTC-1.25-11T  |
|                                    |                 | TGNTC-1.25-11T  |
|                                    |                 | TC0.3-9.5       |
|                                    |                 | TC1.25-11S-ST   |
| Double (2 wires)                   | TC1.25-11S      |                 |
|                                    | TC2-11S         |                 |
| Double (2 wires)                   |                 | TGWVTC-1.25-9T  |
|                                    |                 | TGWVTC-1.25-11T |

### E5□C-B (Controllers with Push-In Plus Terminal Blocks)

#### 1. Connecting Wires to the Push-In Plus Terminal Block Part Names of the Terminal Block

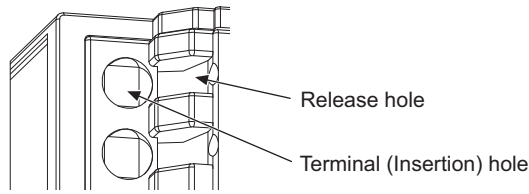

#### Connecting Wires with Ferrules and Solid Wires

Insert the solid wire or ferrule straight into the terminal block until the end touches the terminal block.

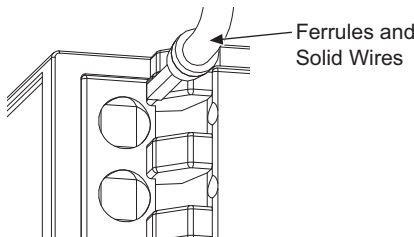

If a wire is difficult to connect because it is too thin, use a flat-blade screwdriver in the same way as when connecting stranded wire.

#### Connecting Stranded Wires

Use the following procedure to connect the wires to the terminal block.

1. Hold a flat-blade screwdriver at an angle and insert it into the release hole. The angle should be between 10° and 15°. If the flat-blade screwdriver is inserted correctly, you will feel the spring in the release hole.
2. With the flat-blade screwdriver still inserted into the release hole, insert the wire into the terminal hole until it strikes the terminal block.
3. Remove the flat-blade screwdriver from the release hole.

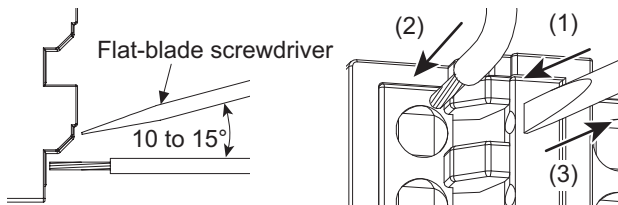

#### Checking Connections

- After the insertion, pull gently on the wire to make sure that it will not come off and the wire is securely fastened to the terminal block.
- If you use a ferrule with a conductor length of 10 mm, part of the conductor may be visible after the ferrule is inserted into the terminal block, but the product insulation distance will still be satisfied.

#### 2. Removing Wires from the Push-In Plus Terminal Block

Use the following procedure to remove wires from the terminal block. The same method is used to remove stranded wires, solid wires, and ferrules.

1. Hold a flat-blade screwdriver at an angle and insert it into the release hole.
2. With the flat-blade screwdriver still inserted into the release hole, remove the wire from the terminal insertion hole.
3. Remove the flat-blade screwdriver from the release hole.

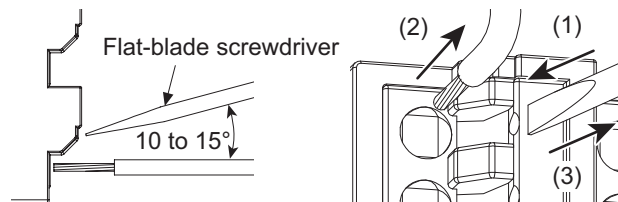

#### 3. Recommended Ferrules and Crimp Tools Recommended ferrules

| Applicable wire        |       | Ferrule Conductor length (mm) | Wire Stripping length (mm) (Ferrules used) | Recommended ferrules                     |                    |                |
|------------------------|-------|-------------------------------|--|--|--------------------|----------------|
| (mm <sup>2</sup> )     | (AWG) |                               |  | Phoenix Contact product                  | Weidmuller product | Wago product   |
| 0.25                   | 24    | 8                             | 10   | AI 0.25-8                                | H0.25/12           | FE-0.25-8N-YE  |
|                        |       | 10                            | 12   | AI 0.25-10                               | ---                | ---            |
| 0.34                   | 22    | 8                             | 10   | AI 0.34-8                                | H0.34/12           | FE-0.34-8N-TQ  |
|                        |       | 10                            | 12   | AI 0.34-10                               | ---                | ---            |
| 0.5                    | 20    | 8                             | 10   | AI 0.5-8                                 | H0.5/14            | FE-0.5-8N-WH   |
|                        |       | 10                            | 12   | AI 0.5-10                                | H0.5/16            | FE-0.5-10N-WH  |
| 0.75                   | 18    | 8                             | 10   | AI 0.75-8                                | H0.75/14           | FE-0.75-8N-GY  |
|                        |       | 10                            | 12   | AI 0.75-10                               | H0.75/16           | FE-0.75-10N-GY |
| 1/1.25                 | 18/17 | 8                             | 10   | AI 1-8                                   | H1.0/14            | FE-1.0-8N-RD   |
|                        |       | 10                            | 12   | AI 1-10                                  | H1.0/16            | FE-1.0-10N-RD  |
| 1.25/1.5               | 17/16 | 8                             | 10   | AI 1.5-8                                 | H1.5/14            | FE-1.5-8N-BK   |
|                        |       | 10                            | 12   | AI 1.5-10                                | H1.5/16            | FE-1.5-10N-BK  |
| Recommended crimp tool |       |                               |  | CRIMPFOX6<br>CRIMPFOX6T-F<br>CRIMPFOX10S | PZ6 roto           | Variocrimp4    |

- Note:**
1. Make sure that the outer diameter of the wire coating is smaller than the inner diameter of the insulation sleeve of the recommended ferrule.
  2. Make sure that the ferrule processing dimensions conform to the following figures.

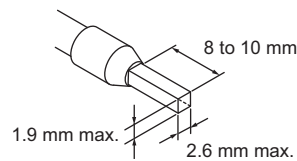

#### Recommended Flat-blade Screwdriver

Use a flat-blade screwdriver to connect and remove wires.

Use the following flat-blade screwdriver.

The following table shows manufacturers and models as of 2015/Dec.

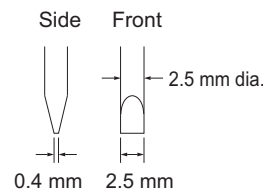

| Model                          | Manufacturer    |
|--------------------------------|-----------------|
| ESD0.40X2.5                    | Wera            |
| SZS 0.4X2.5<br>SZF 0-0.4X2.5 * | Phoenix Contact |
| 0.4X2.5X75 302                 | Wiha            |
| AEF.2.5X75                     | Facom           |
| 210-719                        | Wago            |
| SDI 0.4X2.5X75                 | Weidmuller      |

\* OMRON's exclusive purchase model XW4Z-00B is available to order as SZF 0-0.4X2.5 (manufactured by Phoenix Contact).

## Three-year Guarantee

---

### Period of Guarantee

The guarantee period of the Unit is three years starting from the date the Unit is shipped from the factory.

### Scope of Guarantee

The Unit is guaranteed under the following operating conditions.

1. Average Operating Temperature  
(see note):  $-10^{\circ}\text{C}$  to  $50^{\circ}\text{C}$
2. Mounting Method: Standard mounting  
(Mounted to panel or DIN Track.)

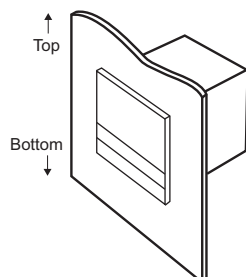

Example: Mounted to Panel

#### **Note:** Average Operating Temperature

Refer to the process temperature of the Unit mounted to a control panel and connected to peripheral devices on condition that the Unit is in stable operation, sensor input type K is selected for the Unit, the positive and negative thermocouple input terminals of the Unit are short-circuited, and the ambient temperature is stable.

Should the Unit malfunction during the guarantee period, OMRON shall repair the Unit or replace any parts of the Unit at the expense of OMRON.



# Terms and Conditions Agreement

## **Read and understand this catalog.**

Please read and understand this catalog before purchasing the products. Please consult your OMRON representative if you have any questions or comments.

## **Warranties.**

(a) Exclusive Warranty. Omron's exclusive warranty is that the Products will be free from defects in materials and workmanship for a period of twelve months from the date of sale by Omron (or such other period expressed in writing by Omron). Omron disclaims all other warranties, express or implied.

(b) Limitations. OMRON MAKES NO WARRANTY OR REPRESENTATION, EXPRESS OR IMPLIED, ABOUT NON-INFRINGEMENT, MERCHANTABILITY OR FITNESS FOR A PARTICULAR PURPOSE OF THE PRODUCTS. BUYER ACKNOWLEDGES THAT IT ALONE HAS DETERMINED THAT THE PRODUCTS WILL SUITABLY MEET THE REQUIREMENTS OF THEIR INTENDED USE.

Omron further disclaims all warranties and responsibility of any type for claims or expenses based on infringement by the Products or otherwise of any intellectual property right. (c) Buyer Remedy. Omron's sole obligation hereunder shall be, at Omron's election, to (i) replace (in the form originally shipped with Buyer responsible for labor charges for removal or replacement thereof) the non-complying Product, (ii) repair the non-complying Product, or (iii) repay or credit Buyer an amount equal to the purchase price of the non-complying Product; provided that in no event shall Omron be responsible for warranty, repair, indemnity or any other claims or expenses regarding the Products unless Omron's analysis confirms that the Products were properly handled, stored, installed and maintained and not subject to contamination, abuse, misuse or inappropriate modification. Return of any Products by Buyer must be approved in writing by Omron before shipment. Omron Companies shall not be liable for the suitability or unsuitability or the results from the use of Products in combination with any electrical or electronic components, circuits, system assemblies or any other materials or substances or environments. Any advice, recommendations or information given orally or in writing, are not to be construed as an amendment or addition to the above warranty.

See <http://www.omron.com/global/> or contact your Omron representative for published information.

## **Limitation on Liability; Etc.**

OMRON COMPANIES SHALL NOT BE LIABLE FOR SPECIAL, INDIRECT, INCIDENTAL, OR CONSEQUENTIAL DAMAGES, LOSS OF PROFITS OR PRODUCTION OR COMMERCIAL LOSS IN ANY WAY CONNECTED WITH THE PRODUCTS, WHETHER SUCH CLAIM IS BASED IN CONTRACT, WARRANTY, NEGLIGENCE OR STRICT LIABILITY.

Further, in no event shall liability of Omron Companies exceed the individual price of the Product on which liability is asserted.

## **Suitability of Use.**

Omron Companies shall not be responsible for conformity with any standards, codes or regulations which apply to the combination of the Product in the Buyer's application or use of the Product. At Buyer's request, Omron will provide applicable third party certification documents identifying ratings and limitations of use which apply to the Product. This information by itself is not sufficient for a complete determination of the suitability of the Product in combination with the end product, machine, system, or other application or use. Buyer shall be solely responsible for determining appropriateness of the particular Product with respect to Buyer's application, product or system. Buyer shall take application responsibility in all cases.

NEVER USE THE PRODUCT FOR AN APPLICATION INVOLVING SERIOUS RISK TO LIFE OR PROPERTY OR IN LARGE QUANTITIES WITHOUT ENSURING THAT THE SYSTEM AS A WHOLE HAS BEEN DESIGNED TO ADDRESS THE RISKS, AND THAT THE OMRON PRODUCT(S) IS PROPERLY RATED AND INSTALLED FOR THE INTENDED USE WITHIN THE OVERALL EQUIPMENT OR SYSTEM.

## **Programmable Products.**

Omron Companies shall not be responsible for the user's programming of a programmable Product, or any consequence thereof.

## **Performance Data.**

Data presented in Omron Company websites, catalogs and other materials is provided as a guide for the user in determining suitability and does not constitute a warranty. It may represent the result of Omron's test conditions, and the user must correlate it to actual application requirements. Actual performance is subject to the Omron's Warranty and Limitations of Liability.

## **Change in Specifications.**

Product specifications and accessories may be changed at any time based on improvements and other reasons. It is our practice to change part numbers when published ratings or features are changed, or when significant construction changes are made. However, some specifications of the Product may be changed without any notice. When in doubt, special part numbers may be assigned to fix or establish key specifications for your application. Please consult with your Omron's representative at any time to confirm actual specifications of purchased Product.

## **Errors and Omissions.**

Information presented by Omron Companies has been checked and is believed to be accurate; however, no responsibility is assumed for clerical, typographical or proofreading errors or omissions.

**OMRON Corporation** Industrial Automation Company  
Kyoto, JAPAN

Contact: [www.ia.omron.com](http://www.ia.omron.com)

**Regional Headquarters**

**OMRON EUROPE B.V.**

Wegalaan 67-69, 2132 JD Hoofddorp  
The Netherlands  
Tel: (31)2356-81-300/Fax: (31)2356-81-388

**OMRON ELECTRONICS LLC**

2895 Greenspoint Parkway, Suite 200  
Hoffman Estates, IL 60169 U.S.A.  
Tel: (1) 847-843-7900/Fax: (1) 847-843-7787

**OMRON ASIA PACIFIC PTE. LTD.**

No. 438A Alexandra Road # 05-05/08 (Lobby 2),  
Alexandra Technopark,  
Singapore 119967  
Tel: (65) 6835-3011/Fax: (65) 6835-2711

**OMRON (CHINA) CO., LTD.**

Room 2211, Bank of China Tower,  
200 Yin Cheng Zhong Road,  
PuDong New Area, Shanghai, 200120, China  
Tel: (86) 21-5037-2222/Fax: (86) 21-5037-2200

Authorized Distributor:

© OMRON Corporation 2011-2016 All Rights Reserved.  
In the interest of product improvement,  
specifications are subject to change without notice.

**CSM\_14\_3\_0317**  
**Cat. No. H177-E1-09**

0316 (1111)



## X-ON Electronics

Largest Supplier of Electrical and Electronic Components

*Click to view similar products for [Controllers](#) category:*

*Click to view products by [Omron](#) manufacturer:*

Other Similar products are found below :

[CS1WCN223](#) [CS1WCN713](#) [CS1WKS001E](#) [61F-11NH](#) [61FGPN8DAC120](#) [61F-GP-NT AC110](#) [61F-GPN-V50-AC110](#) [70177-1011](#) [F03-03](#)  
[HAS B](#) [F03-03 HAS C](#) [F03-31](#) [81513201](#) [81513535](#) [81550401](#) [FT1A-C12RA-W](#) [88981106](#) [H2CAC24A](#) [R88A-CAGA005S](#) [R88A-](#)  
[CRGB003CR-E](#) [R88ARR080100S](#) [R88A-TK01K](#) [DCN1-1](#) [DTB4896VRE](#) [DTB9696CVE](#) [DTB9696LVE](#) [MR-50LF+](#) [E53-AZ01](#) [E53E8C](#)  
[E5CWLQ1TCAC100240](#) [B300LKL21](#) [NE1ASCPU02EIPVER11](#) [NE1SCPU01](#) [NE1SDRM21U](#) [NSCXDC1V3](#) [NSH5-232CW-3M](#)  
[NT20SST122BV1](#) [NV3Q-SW41](#) [NV4W-ATT01](#) [NV-CN001](#) [OAS-160-N](#) [K31S6](#) [K33-L1B](#) [K3TX-AD31A](#) [L595020](#) [SRS2-1](#) [G32X-V2K](#)  
[26546803](#) [26546805](#) [26546831](#) [CJ1W-OD204](#)