

Automotive-Grade, Galvanically Isolated Current Sensor IC With Common-Mode Field Rejection in a Small-Footprint SOIC8 Package

FEATURES AND BENEFITS

- Differential Hall sensing rejects common-mode fields
- 1.2 mΩ primary conductor resistance for low power loss and high inrush current withstand capability
- Integrated shield virtually eliminates capacitive coupling from current conductor to die, greatly suppressing output noise due to high dv/dt transients
- Industry-leading noise performance with greatly improved bandwidth through proprietary amplifier and filter design techniques
- High-bandwidth 120 kHz analog output for faster response times in control applications
- Filter pin allows user to filter the output for improved resolution at lower bandwidth
- Patented integrated digital temperature compensation circuitry allows for near closed loop accuracy over temperature in an open loop sensor
- Small-footprint, low-profile SOIC8 package suitable for space-constrained applications
- Filter pin simplifies bandwidth limiting for better resolution at lower frequencies

Continued on the next page...

Package: 8-Pin SOIC (suffix LC)



TÜV America
Certificate Number:
U8V 14 11 54214 032
CB 14 11 54214 031



CB Certificate Number:
US-22334-A2-UL

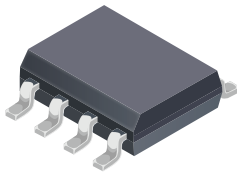

Approximate Scale 1:1

DESCRIPTION

The Allegro™ ACS724 current sensor IC is an economical and precise solution for AC or DC current sensing in industrial, automotive, commercial, and communications systems. The small package is ideal for space-constrained applications while also saving costs due to reduced board area. Typical applications include motor control, load detection and management, switched-mode power supplies, and overcurrent fault protection.

The device consists of a precise, low-offset, linear Hall sensor circuit with a copper conduction path located near the surface of the die. Applied current flowing through this copper conduction path generates a magnetic field which is sensed by the integrated Hall IC and converted into a proportional voltage. The current is sensed differentially in order to reject common-mode fields, improving accuracy in magnetically noisy environments. The inherent device accuracy is optimized through the close proximity of the magnetic field to the Hall transducer. A precise, proportional voltage is provided by the low-offset, chopper-stabilized BiCMOS Hall IC, which is programmed for accuracy after packaging. The output of the device has a positive slope when an increasing current flows through the primary copper conduction path (from pins 1 and 2, to pins 3 and 4), which is the path used for current sensing. The internal resistance of this conductive path is 1.2 mΩ typical, providing low power loss.

The terminals of the conductive path are electrically isolated from the sensor leads (pins 5 through 8). This allows the ACS724 current sensor IC to be used in high-side current sense applications without the use of high-side differential amplifiers or other costly isolation techniques.

Continued on the next page...

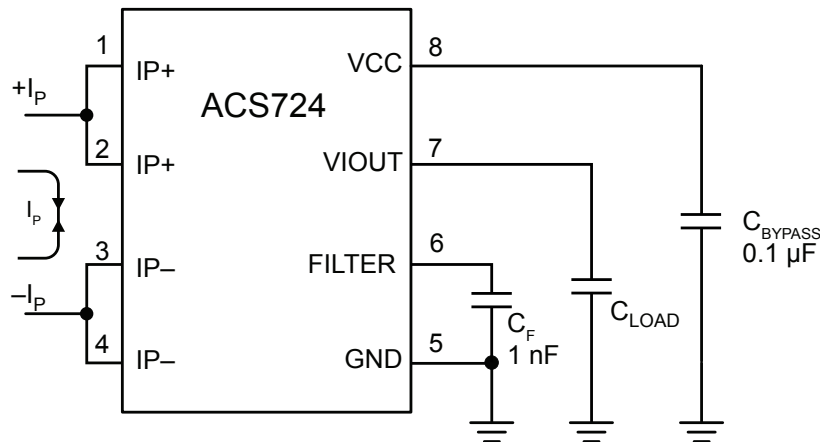

The ACS724 outputs an analog signal, V_{IOUT} , that changes proportionally with the bidirectional AC or DC primary sensed current, I_P , within the specified measurement range. The FILTER pin can be used to decrease the bandwidth in order to optimize the noise performance.

Typical Application

ACS724

Automotive-Grade, Galvanically Isolated Current Sensor IC With Common-Mode Field Rejection in a Small-Footprint SOIC8 Package

Features and Benefits (continued)

- 5 V, single supply operation
- Output voltage proportional to AC or DC current
- Factory-trimmed sensitivity and quiescent output voltage for improved accuracy
- Chopper stabilization results in extremely stable quiescent output voltage
- Nearly zero magnetic hysteresis
- Ratiometric output from supply voltage

Description (continued)

The ACS724 is provided in a small, low-profile surface-mount SOIC8 package. The leadframe is plated with 100% matte tin, which is compatible with standard lead (Pb) free printed circuit board assembly processes. Internally, the device is Pb-free, except for flip-chip high-temperature Pb-based solder balls, currently exempt from RoHS. The device is fully calibrated prior to shipment from the factory.

Selection Guide

| Part Number | I_{PR} (A) | Sens(Typ) at $V_{CC} = 5\text{ V}$ (mV/A) | T_A (°C) | Packing* |
|--------------------|-----------------|---|---------------|-------------------------------------|
| ACS724LLCTR-05AB-T | ±5 | 400 | -40 to 150 | Tape and Reel, 3000 pieces per reel |
| ACS724LLCTR-10AU-T | 10 | 400 | | |
| ACS724LLCTR-10AB-T | ±10 | 200 | | |
| ACS724LLCTR-20AU-T | 20 | | | |
| ACS724LLCTR-20AB-T | ±20 | 100 | | |
| ACS724LLCTR-30AU-T | 30 | 133 | | |
| ACS724LLCTR-30AB-T | ±30 | 66 | | |
| ACS724LLCTR-50AB-T | ±50 | 40 | | |

*Contact Allegro for additional packing options.

SPECIFICATIONS

Absolute Maximum Ratings

| Characteristic | Symbol | Notes | Rating | Units |
|-------------------------------|-------------------|---------|----------------|-------|
| Supply Voltage | V_{CC} | | 6 | V |
| Reverse Supply Voltage | V_{RCC} | | -0.1 | V |
| Output Voltage | V_{IOUT} | | $V_{CC} + 0.5$ | V |
| Reverse Output Voltage | V_{RIOUT} | | -0.1 | V |
| Operating Ambient Temperature | T_A | Range L | -40 to 150 | °C |
| Junction Temperature | $T_J(\text{max})$ | | 165 | °C |
| Storage Temperature | T_{stg} | | -65 to 165 | °C |

Isolation Characteristics

| Characteristic | Symbol | Notes | Rating | Unit |
|-------------------------------------|------------|--|--------|-----------------|
| Dielectric Strength Test Voltage | V_{ISO} | Agency type-tested for 60 seconds per UL standard 60950-1 (edition 2); production-tested at V_{ISO} for 1 second, in accordance with UL 60950-1 (edition 2). | 2400 | V_{RMS} |
| Working Voltage for Basic Isolation | V_{WVBI} | Maximum approved working voltage for basic (single) isolation according to UL 60950-1 (edition 2) | 420 | V_{pk} or VDC |
| | | | 297 | V_{rms} |
| Clearance | D_{cl} | Minimum distance through air from IP leads to signal leads. | 3.9 | mm |
| Creepage | D_{cr} | Minimum distance along package body from IP leads to signal leads. | 3.9 | mm |

Thermal Characteristics

| Characteristic | Symbol | Test Conditions* | Value | Units |
|--|-----------------|---|-------|-------|
| Package Thermal Resistance (Junction to Ambient) | $R_{\theta JA}$ | Mounted on the Allegro 85-0740 evaluation board with 800 mm ² of 4 oz. copper on each side, connected to pins 1 and 2, and to pins 3 and 4, with thermal vias connecting the layers. Performance values include the power consumed by the PCB. | 23 | °C/W |
| Package Thermal Resistance (Junction to Lead) | $R_{\theta JL}$ | Mounted on the Allegro ASEK724 evaluation board. | 5 | °C/W |

*Additional thermal information available on the Allegro website.

ACS724

*Automotive-Grade, Galvanically Isolated Current Sensor IC
With Common-Mode Field Rejection in a Small-Footprint SOIC8 Package*

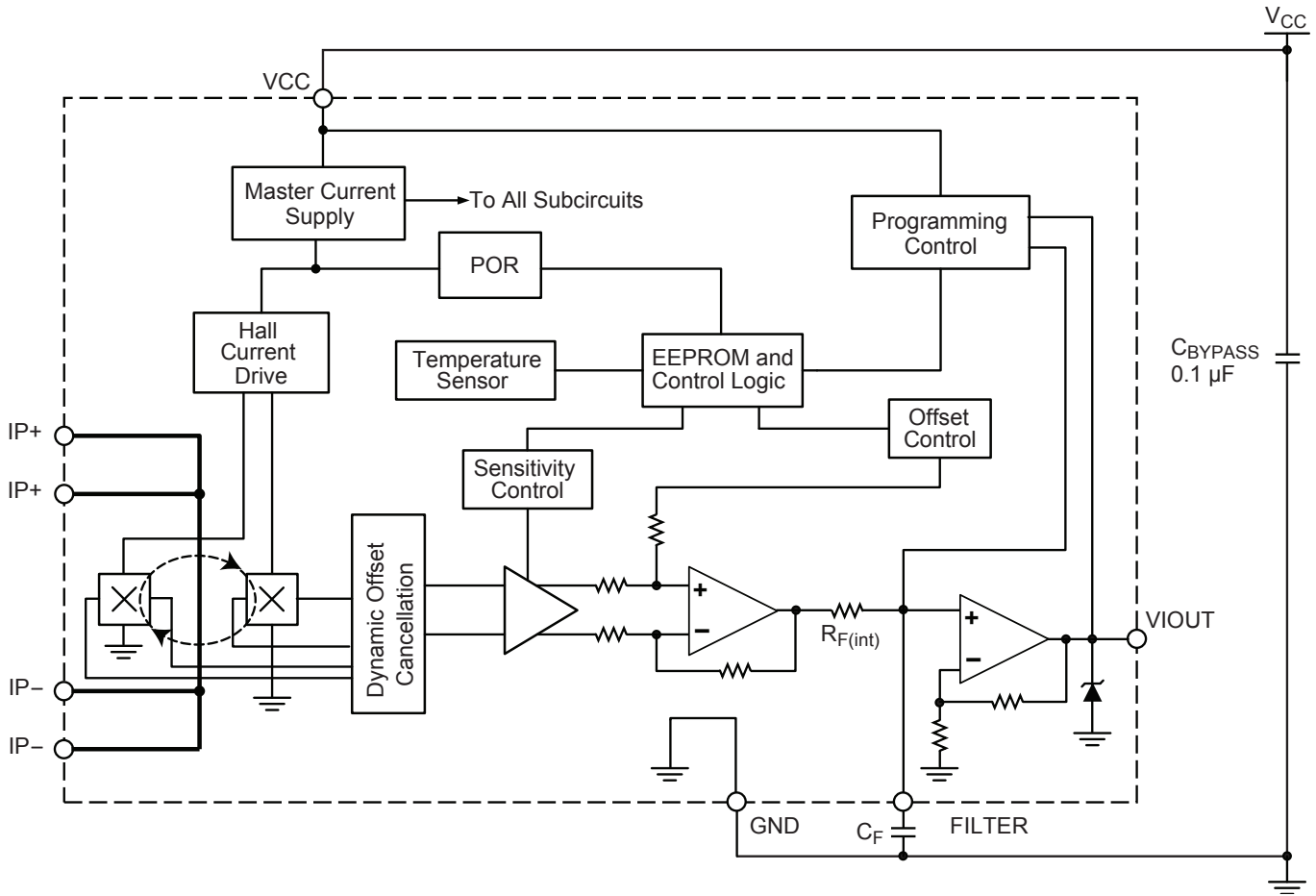

Functional Block Diagram

Pin-Out Diagram and Terminal List Table

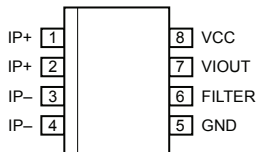

Package LC, 8-Pin SOICN
Pin-Out Diagram

Terminal List Table

| Number | Name | Description |
|--------|--------|--|
| 1, 2 | IP+ | Terminals for current being sensed; fused internally |
| 3, 4 | IP- | Terminals for current being sensed; fused internally |
| 5 | GND | Signal ground terminal |
| 6 | FILTER | Terminal for external capacitor that sets bandwidth |
| 7 | VIOUT | Analog output signal |
| 8 | VCC | Device power supply terminal |

COMMON ELECTRICAL CHARACTERISTICS¹: valid through the full range of T_A , $V_{CC} = 5\text{ V}$, $C_F = 0$, unless otherwise specified

| Characteristic | Symbol | Test Conditions | Min. | Typ. | Max. | Unit |
|--|-----------------------|--|--------|----------------|--------|--|
| Supply Voltage | V_{CC} | | 4.5 | – | 5.5 | V |
| Supply Current | I_{CC} | $V_{CC} = 5\text{ V}$, output open | – | 10 | 14 | mA |
| Output Capacitance Load | C_L | VIOUT to GND | – | – | 10 | nF |
| Output Resistive Load | R_L | VIOUT to GND | 4.7 | – | – | k Ω |
| Primary Conductor Resistance | R_{IP} | $T_A = 25^\circ\text{C}$ | – | 1.2 | – | m Ω |
| Internal Filter Resistance ² | $R_{F(int)}$ | | – | 1.8 | – | k Ω |
| Primary Hall Coupling Factor | G1 | $T_A = 25^\circ\text{C}$ | – | 11 | – | G/A |
| Secondary Hall Coupling Factor | G2 | $T_A = 25^\circ\text{C}$ | – | 2.8 | – | G/A |
| Hall Plate Sensitivity Matching | Sens _{match} | $T_A = 25^\circ\text{C}$ | – | ± 1 | – | % |
| Rise Time | t_r | $I_P = I_{P(max)}$, $T_A = 25^\circ\text{C}$, $C_L = 1\text{ nF}$ | – | 3 | – | μs |
| Propagation Delay | t_{pd} | $I_P = I_{P(max)}$, $T_A = 25^\circ\text{C}$, $C_L = 1\text{ nF}$ | – | 2 | – | μs |
| Response Time | $t_{RESPONSE}$ | $I_P = I_{P(max)}$, $T_A = 25^\circ\text{C}$, $C_L = 1\text{ nF}$ | – | 4 | – | μs |
| Bandwidth | BW | Small signal -3 dB ; $C_L = 1\text{ nF}$ | – | 120 | – | kHz |
| Noise Density | I_{ND} | Input-referenced noise density; $T_A = 25^\circ\text{C}$, $C_L = 1\text{ nF}$ | – | 150 | – | $\mu\text{A}_{(rms)}/\sqrt{\text{Hz}}$ |
| Noise | I_N | Input-referenced noise: $C_F = 4.7\text{ nF}$, $C_L = 1\text{ nF}$, BW = 18 kHz, $T_A = 25^\circ\text{C}$ | – | 20 | – | $\text{mA}_{(rms)}$ |
| Nonlinearity | E_{LIN} | Through full range of I_P | -1.5 | – | $+1.5$ | % |
| Sensitivity Ratiometry Coefficient | SENS_RAT_COEF | $V_{CC} = 4.5\text{ to }5.5\text{ V}$, $T_A = 25^\circ\text{C}$ | – | 1.3 | – | – |
| Zero-Current Output Ratiometry Coefficient | QVO_RAT_COEF | $V_{CC} = 4.5\text{ to }5.5\text{ V}$, $T_A = 25^\circ\text{C}$ | – | 1 | – | – |
| Saturation Voltage ³ | V_{OH} | $R_L = 4.7\text{ k}\Omega$ | – | $V_{CC} - 0.3$ | – | V |
| | V_{OL} | $R_L = 4.7\text{ k}\Omega$ | – | 0.3 | – | V |
| Power-On Time | t_{PO} | Output reaches 90% of steady-state level, $T_A = 25^\circ\text{C}$, $I_P = I_{PR(max)}$ applied | – | 80 | – | μs |
| Shorted Output-to-Ground Current | $I_{SC(GND)}$ | $T_A = 25^\circ\text{C}$ | – | 3.3 | – | mA |
| Shorted Output-to- V_{CC} Current | $I_{SC(VCC)}$ | $T_A = 25^\circ\text{C}$ | – | 45 | – | mA |

¹Device may be operated at higher primary current levels, I_P , ambient temperatures, T_A , and internal leadframe temperatures, provided the Maximum Junction Temperature, $T_J(max)$, is not exceeded.

² $R_{F(int)}$ forms an RC circuit via the FILTER pin.

³The sensor IC will continue to respond to current beyond the range of I_P until the high or low saturation voltage; however, the nonlinearity in this region will be worse than through the rest of the measurement range.

xLLCTR-05AB PERFORMANCE CHARACTERISTICS: T_A Range L, valid at $T_A = -40^\circ\text{C}$ to 150°C , $V_{CC} = 5\text{ V}$, unless otherwise specified

| Characteristic | Symbol | Test Conditions | Min. | Typ. ¹ | Max. | Unit |
|---|-------------------|--|------|---------------------|------|------|
| Nominal Performance | | | | | | |
| Current-Sensing Range | I_{PR} | | -5 | - | 5 | A |
| Sensitivity | Sens | $I_{PR(\min)} < I_P < I_{PR(\max)}$ | - | 400 | - | mV/A |
| Zero-Current Output Voltage | $V_{IOUT(Q)}$ | Bidirectional, $I_P = 0\text{ A}$ | - | $V_{CC} \times 0.5$ | - | V |
| Accuracy Performance | | | | | | |
| Total Output Error ² | E_{TOT} | $I_P = I_{PR(\max)}$, $T_A = 25^\circ\text{C}$ to 150°C | -2.5 | ± 1.5 | 2.5 | % |
| | | $I_P = I_{PR(\max)}$, $T_A = -40^\circ\text{C}$ to 25°C | -6 | ± 4.5 | 6 | % |
| Total Output Error Components³ $E_{TOT} = E_{SENS} + 100 \times V_{OE} / (\text{Sens} \times I_P)$ | | | | | | |
| Sensitivity Error | E_{sens} | $I_P = I_{PR(\max)}$, $T_A = 25^\circ\text{C}$ to 150°C | -2 | ± 1 | 2 | % |
| | | $I_P = I_{PR(\max)}$, $T_A = -40^\circ\text{C}$ to 25°C | -5.5 | ± 4.5 | 5.5 | % |
| Offset Voltage | V_{OE} | $I_P = 0\text{ A}$, $T_A = 25^\circ\text{C}$ to 150°C | -15 | ± 7 | 15 | mV |
| | | $I_P = 0\text{ A}$, $T_A = -40^\circ\text{C}$ to 25°C | -30 | ± 13 | 30 | mV |
| Lifetime Drift Characteristics | | | | | | |
| Sensitivity Error Lifetime Drift | E_{sens_drift} | | -3 | ± 1 | 3 | % |
| Total Output Error Lifetime Drift | E_{tot_drift} | | -3 | ± 1 | 3 | % |

¹ Typical values with +/- are 3 sigma values

² Percentage of I_P , with $I_P = I_{PR(\max)}$.

³ A single part will not have both the maximum/minimum sensitivity error and maximum/minimum offset voltage, as that would violate the maximum/minimum total output error specification. Also, 3 sigma distribution values are combined by taking the square root of the sum of the squares. See Application Information section.

xLLCTR-10AU PERFORMANCE CHARACTERISTICS: T_A Range L, valid at $T_A = -40^\circ\text{C}$ to 150°C , $V_{CC} = 5\text{ V}$, unless otherwise specified

| Characteristic | Symbol | Test Conditions | Min. | Typ. ¹ | Max. | Unit |
|---|-------------------|--|------|---------------------|------|------|
| Nominal Performance | | | | | | |
| Current-Sensing Range | I_{PR} | | 0 | – | 10 | A |
| Sensitivity | Sens | $I_{PR(\min)} < I_P < I_{PR(\max)}$ | – | 400 | – | mV/A |
| Zero-Current Output Voltage | $V_{IOUT(Q)}$ | Unidirectional, $I_P = 0\text{ A}$ | – | $V_{CC} \times 0.1$ | – | V |
| Accuracy Performance | | | | | | |
| Total Output Error ² | E_{TOT} | $I_P = I_{PR(\max)}$, $T_A = 25^\circ\text{C}$ to 150°C | –2.5 | ± 1.5 | 2.5 | % |
| | | $I_P = I_{PR(\max)}$, $T_A = -40^\circ\text{C}$ to 25°C | –6 | ± 4.5 | 6 | % |
| Total Output Error Components³ $E_{TOT} = E_{SENS} + 100 \times V_{OE} / (\text{Sens} \times I_P)$ | | | | | | |
| Sensitivity Error | E_{sens} | $I_P = I_{PR(\max)}$, $T_A = 25^\circ\text{C}$ to 150°C | –2 | ± 1 | 2 | % |
| | | $I_P = I_{PR(\max)}$, $T_A = -40^\circ\text{C}$ to 25°C | –5.5 | ± 4.5 | 5.5 | % |
| Offset Voltage | V_{OE} | $I_P = 0\text{ A}$, $T_A = 25^\circ\text{C}$ to 150°C | –15 | ± 7 | 15 | mV |
| | | $I_P = 0\text{ A}$, $T_A = -40^\circ\text{C}$ to 25°C | –30 | ± 13 | 30 | mV |
| Lifetime Drift Characteristics | | | | | | |
| Sensitivity Error Lifetime Drift | E_{sens_drift} | | –3 | ± 1 | 3 | % |
| Total Output Error Lifetime Drift | E_{tot_drift} | | –3 | ± 1 | 3 | % |

¹ Typical values with +/- are 3 sigma values

² Percentage of I_P , with $I_P = I_{PR(\max)}$.

³ A single part will not have both the maximum/minimum sensitivity error and maximum/minimum offset voltage, as that would violate the maximum/minimum total output error specification. Also, 3 sigma distribution values are combined by taking the square root of the sum of the squares. See Application Information section.

xLLCTR-10AB PERFORMANCE CHARACTERISTICS: T_A Range L, valid at $T_A = -40^\circ\text{C}$ to 150°C , $V_{CC} = 5\text{ V}$, unless otherwise specified

| Characteristic | Symbol | Test Conditions | Min. | Typ. ¹ | Max. | Unit |
|---|-------------------|--|------|---------------------|------|------|
| Nominal Performance | | | | | | |
| Current-Sensing Range | I_{PR} | | -10 | - | 10 | A |
| Sensitivity | Sens | $I_{PR(\min)} < I_P < I_{PR(\max)}$ | - | 200 | - | mV/A |
| Zero-Current Output Voltage | $V_{IOUT(Q)}$ | Bidirectional, $I_P = 0\text{ A}$ | - | $V_{CC} \times 0.5$ | - | V |
| Accuracy Performance | | | | | | |
| Total Output Error ² | E_{TOT} | $I_P = I_{PR(\max)}$, $T_A = 25^\circ\text{C}$ to 150°C | -2 | ± 1 | 2 | % |
| | | $I_P = I_{PR(\max)}$, $T_A = -40^\circ\text{C}$ to 25°C | -6 | ± 4.5 | 6 | % |
| Total Output Error Components³ $E_{TOT} = E_{SENS} + 100 \times V_{OE} / (\text{Sens} \times I_P)$ | | | | | | |
| Sensitivity Error | E_{sens} | $I_P = I_{PR(\max)}$, $T_A = 25^\circ\text{C}$ to 150°C | -1.5 | ± 1 | 1.5 | % |
| | | $I_P = I_{PR(\max)}$, $T_A = -40^\circ\text{C}$ to 25°C | -5.5 | ± 4.5 | 5.5 | % |
| Offset Voltage | V_{OE} | $I_P = 0\text{ A}$, $T_A = 25^\circ\text{C}$ to 150°C | -10 | ± 6 | 10 | mV |
| | | $I_P = 0\text{ A}$, $T_A = -40^\circ\text{C}$ to 25°C | -30 | ± 8 | 30 | mV |
| Lifetime Drift Characteristics | | | | | | |
| Sensitivity Error Lifetime Drift | E_{sens_drift} | | -3 | ± 1 | 3 | % |
| Total Output Error Lifetime Drift | E_{tot_drift} | | -3 | ± 1 | 3 | % |

¹ Typical values with +/- are 3 sigma values

² Percentage of I_P , with $I_P = I_{PR(\max)}$.

³ A single part will not have both the maximum/minimum sensitivity error and maximum/minimum offset voltage, as that would violate the maximum/minimum total output error specification. Also, 3 sigma distribution values are combined by taking the square root of the sum of the squares. See Application Information section.

xLLCTR-20AU PERFORMANCE CHARACTERISTICS: T_A Range L, valid at $T_A = -40^\circ\text{C}$ to 150°C , $V_{CC} = 5\text{ V}$, unless otherwise specified

| Characteristic | Symbol | Test Conditions | Min. | Typ. ¹ | Max. | Unit |
|---|-------------------|--|------|---------------------|------|------|
| Nominal Performance | | | | | | |
| Current-Sensing Range | I_{PR} | | 0 | – | 20 | A |
| Sensitivity | Sens | $I_{PR(\min)} < I_P < I_{PR(\max)}$ | – | 200 | – | mV/A |
| Zero-Current Output Voltage | $V_{IOUT(Q)}$ | Unidirectional, $I_P = 0\text{ A}$ | – | $V_{CC} \times 0.1$ | – | V |
| Accuracy Performance | | | | | | |
| Total Output Error ² | E_{TOT} | $I_P = I_{PR(\max)}$, $T_A = 25^\circ\text{C}$ to 150°C | –2 | ± 0.7 | 2 | % |
| | | $I_P = I_{PR(\max)}$, $T_A = -40^\circ\text{C}$ to 25°C | –6 | ± 4 | 6 | % |
| Total Output Error Components³ $E_{TOT} = E_{SENS} + 100 \times V_{OE} / (\text{Sens} \times I_P)$ | | | | | | |
| Sensitivity Error | E_{sens} | $I_P = I_{PR(\max)}$, $T_A = 25^\circ\text{C}$ to 150°C | –1.5 | ± 0.7 | 1.5 | % |
| | | $I_P = I_{PR(\max)}$, $T_A = -40^\circ\text{C}$ to 25°C | –5.5 | ± 4 | 5.5 | % |
| Offset Voltage | V_{OE} | $I_P = 0\text{ A}$, $T_A = 25^\circ\text{C}$ to 150°C | –10 | ± 6 | 10 | mV |
| | | $I_P = 0\text{ A}$, $T_A = -40^\circ\text{C}$ to 25°C | –30 | ± 8 | 30 | mV |
| Lifetime Drift Characteristics | | | | | | |
| Sensitivity Error Lifetime Drift | E_{sens_drift} | | –3 | ± 1 | 3 | % |
| Total Output Error Lifetime Drift | E_{tot_drift} | | –3 | ± 1 | 3 | % |

¹ Typical values with +/- are 3 sigma values

² Percentage of I_P , with $I_P = I_{PR(\max)}$.

³ A single part will not have both the maximum/minimum sensitivity error and maximum/minimum offset voltage, as that would violate the maximum/minimum total output error specification. Also, 3 sigma distribution values are combined by taking the square root of the sum of the squares. See Application Information section.

xLLCTR-20AB PERFORMANCE CHARACTERISTICS: T_A Range L, valid at $T_A = -40^\circ\text{C}$ to 150°C , $V_{CC} = 5\text{ V}$, unless otherwise specified

| Characteristic | Symbol | Test Conditions | Min. | Typ. ¹ | Max. | Unit |
|---|-------------------|--|------|---------------------|------|------|
| Nominal Performance | | | | | | |
| Current-Sensing Range | I_{PR} | | -20 | - | 20 | A |
| Sensitivity | Sens | $I_{PR(\min)} < I_P < I_{PR(\max)}$ | - | 100 | - | mV/A |
| Zero-Current Output Voltage | $V_{IOUT(Q)}$ | Bidirectional, $I_P = 0\text{ A}$ | - | $V_{CC} \times 0.5$ | - | V |
| Accuracy Performance | | | | | | |
| Total Output Error ² | E_{TOT} | $I_P = I_{PR(\max)}$, $T_A = 25^\circ\text{C}$ to 150°C | -2 | ± 0.8 | 2 | % |
| | | $I_P = I_{PR(\max)}$, $T_A = -40^\circ\text{C}$ to 25°C | -6 | ± 4 | 6 | % |
| Total Output Error Components³ $E_{TOT} = E_{SENS} + 100 \times V_{OE} / (\text{Sens} \times I_P)$ | | | | | | |
| Sensitivity Error | E_{sens} | $I_P = I_{PR(\max)}$, $T_A = 25^\circ\text{C}$ to 150°C | -1.5 | ± 0.6 | 1.5 | % |
| | | $I_P = I_{PR(\max)}$, $T_A = -40^\circ\text{C}$ to 25°C | -5.5 | ± 4 | 5.5 | % |
| Offset Voltage | V_{OE} | $I_P = 0\text{ A}$, $T_A = 25^\circ\text{C}$ to 150°C | -10 | ± 5 | 10 | mV |
| | | $I_P = 0\text{ A}$, $T_A = -40^\circ\text{C}$ to 25°C | -30 | ± 6 | 30 | mV |
| Lifetime Drift Characteristics | | | | | | |
| Sensitivity Error Lifetime Drift | E_{sens_drift} | | -3 | ± 1 | 3 | % |
| Total Output Error Lifetime Drift | E_{tot_drift} | | -3 | ± 1 | 3 | % |

¹ Typical values with +/- are 3 sigma values

² Percentage of I_P , with $I_P = I_{PR(\max)}$.

³ A single part will not have both the maximum/minimum sensitivity error and maximum/minimum offset voltage, as that would violate the maximum/minimum total output error specification. Also, 3 sigma distribution values are combined by taking the square root of the sum of the squares. See Application Information section.

xLLCTR-30AU PERFORMANCE CHARACTERISTICS: T_A Range L, valid at $T_A = -40^\circ\text{C}$ to 150°C , $V_{CC} = 5\text{ V}$, unless otherwise specified

| Characteristic | Symbol | Test Conditions | Min. | Typ. ¹ | Max. | Unit |
|---|-------------------|--|------|---------------------|------|------|
| Nominal Performance | | | | | | |
| Current-Sensing Range | I_{PR} | | 0 | – | 30 | A |
| Sensitivity | Sens | $I_{PR(\min)} < I_P < I_{PR(\max)}$ | – | 133 | – | mV/A |
| Zero-Current Output Voltage | $V_{IOUT(Q)}$ | Unidirectional, $I_P = 0\text{ A}$ | – | $V_{CC} \times 0.1$ | – | V |
| Accuracy Performance | | | | | | |
| Total Output Error ² | E_{TOT} | $I_P = I_{PR(\max)}$, $T_A = 25^\circ\text{C}$ to 150°C | –2 | ± 0.7 | 2 | % |
| | | $I_P = I_{PR(\max)}$, $T_A = -40^\circ\text{C}$ to 25°C | –6 | ± 4 | 6 | % |
| Total Output Error Components³ $E_{TOT} = E_{SENS} + 100 \times V_{OE} / (\text{Sens} \times I_P)$ | | | | | | |
| Sensitivity Error | E_{sens} | $I_P = I_{PR(\max)}$, $T_A = 25^\circ\text{C}$ to 150°C | –1.5 | ± 0.7 | 1.5 | % |
| | | $I_P = I_{PR(\max)}$, $T_A = -40^\circ\text{C}$ to 25°C | –5.5 | ± 4 | 5.5 | % |
| Offset Voltage | V_{OE} | $I_P = 0\text{ A}$, $T_A = 25^\circ\text{C}$ to 150°C | –10 | ± 6 | 10 | mV |
| | | $I_P = 0\text{ A}$, $T_A = -40^\circ\text{C}$ to 25°C | –30 | ± 7 | 30 | mV |
| Lifetime Drift Characteristics | | | | | | |
| Sensitivity Error Lifetime Drift | E_{sens_drift} | | –3 | ± 1 | 3 | % |
| Total Output Error Lifetime Drift | E_{tot_drift} | | –3 | ± 1 | 3 | % |

¹ Typical values with +/- are 3 sigma values

² Percentage of I_P , with $I_P = I_{PR(\max)}$.

³ A single part will not have both the maximum/minimum sensitivity error and maximum/minimum offset voltage, as that would violate the maximum/minimum total output error specification. Also, 3 sigma distribution values are combined by taking the square root of the sum of the squares. See Application Information section.

xLLCTR-30AB PERFORMANCE CHARACTERISTICS: T_A Range L, valid at $T_A = -40^\circ\text{C}$ to 150°C , $V_{CC} = 5\text{ V}$, unless otherwise specified

| Characteristic | Symbol | Test Conditions | Min. | Typ. ¹ | Max. | Unit |
|---|-------------------|--|------|---------------------|------|------|
| Nominal Performance | | | | | | |
| Current-Sensing Range | I_{PR} | | -30 | - | 30 | A |
| Sensitivity | Sens | $I_{PR(\min)} < I_P < I_{PR(\max)}$ | - | 66 | - | mV/A |
| Zero-Current Output Voltage | $V_{IOUT(Q)}$ | Bidirectional, $I_P = 0\text{ A}$ | - | $V_{CC} \times 0.5$ | - | V |
| Accuracy Performance | | | | | | |
| Total Output Error ² | E_{TOT} | $I_P = I_{PR(\max)}$, $T_A = 25^\circ\text{C}$ to 150°C | -2 | ± 0.8 | 2 | % |
| | | $I_P = I_{PR(\max)}$, $T_A = -40^\circ\text{C}$ to 25°C | -6 | ± 4 | 6 | % |
| Total Output Error Components³ $E_{TOT} = E_{SENS} + 100 \times V_{OE} / (\text{Sens} \times I_P)$ | | | | | | |
| Sensitivity Error | E_{sens} | $I_P = I_{PR(\max)}$, $T_A = 25^\circ\text{C}$ to 150°C | -1.5 | ± 0.8 | 1.5 | % |
| | | $I_P = I_{PR(\max)}$, $T_A = -40^\circ\text{C}$ to 25°C | -5.5 | ± 4 | 5.5 | % |
| Offset Voltage | V_{OE} | $I_P = 0\text{ A}$, $T_A = 25^\circ\text{C}$ to 150°C | -10 | ± 6 | 10 | mV |
| | | $I_P = 0\text{ A}$, $T_A = -40^\circ\text{C}$ to 25°C | -30 | ± 6 | 30 | mV |
| Lifetime Drift Characteristics | | | | | | |
| Sensitivity Error Lifetime Drift | E_{sens_drift} | | -3 | ± 1 | 3 | % |
| Total Output Error Lifetime Drift | E_{tot_drift} | | -3 | ± 1 | 3 | % |

¹ Typical values with +/- are 3 sigma values

² Percentage of I_P , with $I_P = I_{PR(\max)}$.

³ A single part will not have both the maximum/minimum sensitivity error and maximum/minimum offset voltage, as that would violate the maximum/minimum total output error specification. Also, 3 sigma distribution values are combined by taking the square root of the sum of the squares. See Application Information section.

xLLCTR-50AB PERFORMANCE CHARACTERISTICS: T_A Range L, valid at $T_A = -40^\circ\text{C}$ to 150°C , $V_{CC} = 5\text{ V}$, $C_F = 0$, unless otherwise specified

| Characteristic | Symbol | Test Conditions | Min. | Typ. ¹ | Max. | Unit |
|---|-------------------|--|------|---------------------|------|------|
| Nominal Performance | | | | | | |
| Current-Sensing Range | I_{PR} | | -50 | - | 50 | A |
| Sensitivity | Sens | $I_{PR(\min)} < I_P < I_{PR(\max)}$ | - | 40 | - | mV/A |
| Zero-Current Output Voltage | $V_{IOUT(Q)}$ | Bidirectional, $I_P = 0\text{ A}$ | - | $V_{CC} \times 0.5$ | - | V |
| Accuracy Performance | | | | | | |
| Total Output Error ² | E_{TOT} | $I_P = I_{PR(\max)}$, $T_A = 25^\circ\text{C}$ to 150°C | -2 | ± 0.8 | 2 | % |
| | | $I_P = I_{PR(\max)}$, $T_A = -40^\circ\text{C}$ to 25°C | -6 | ± 4 | 6 | % |
| Total Output Error Components³ $E_{TOT} = E_{SENS} + 100 \times V_{OE} / (\text{Sens} \times I_P)$ | | | | | | |
| Sensitivity Error | E_{sens} | $I_P = I_{PR(\max)}$, $T_A = 25^\circ\text{C}$ to 150°C | -1.5 | ± 0.8 | 1.5 | % |
| | | $I_P = I_{PR(\max)}$, $T_A = -40^\circ\text{C}$ to 25°C | -5.5 | ± 4 | 5.5 | % |
| Offset Voltage | V_{OE} | $I_P = 0\text{ A}$, $T_A = 25^\circ\text{C}$ to 150°C | -10 | ± 6 | 10 | mV |
| | | $I_P = 0\text{ A}$, $T_A = -40^\circ\text{C}$ to 25°C | -30 | ± 6 | 30 | mV |
| Lifetime Drift Characteristics | | | | | | |
| Sensitivity Error Lifetime Drift | E_{sens_drift} | | -3 | ± 1 | 3 | % |
| Total Output Error Lifetime Drift | E_{tot_drift} | | -3 | ± 1 | 3 | % |

¹ Typical values with +/- are 3 sigma values

² Percentage of I_P , with $I_P = I_{PR(\max)}$

³ A single part will not have both the maximum/minimum sensitivity error and maximum/minimum offset voltage, as that would violate the maximum/minimum total output error specification. Also, 3 sigma distribution values are combined by taking the square root of the sum of the squares. See Application Information section.

CHARACTERISTIC PERFORMANCE xLLCTR-10AU

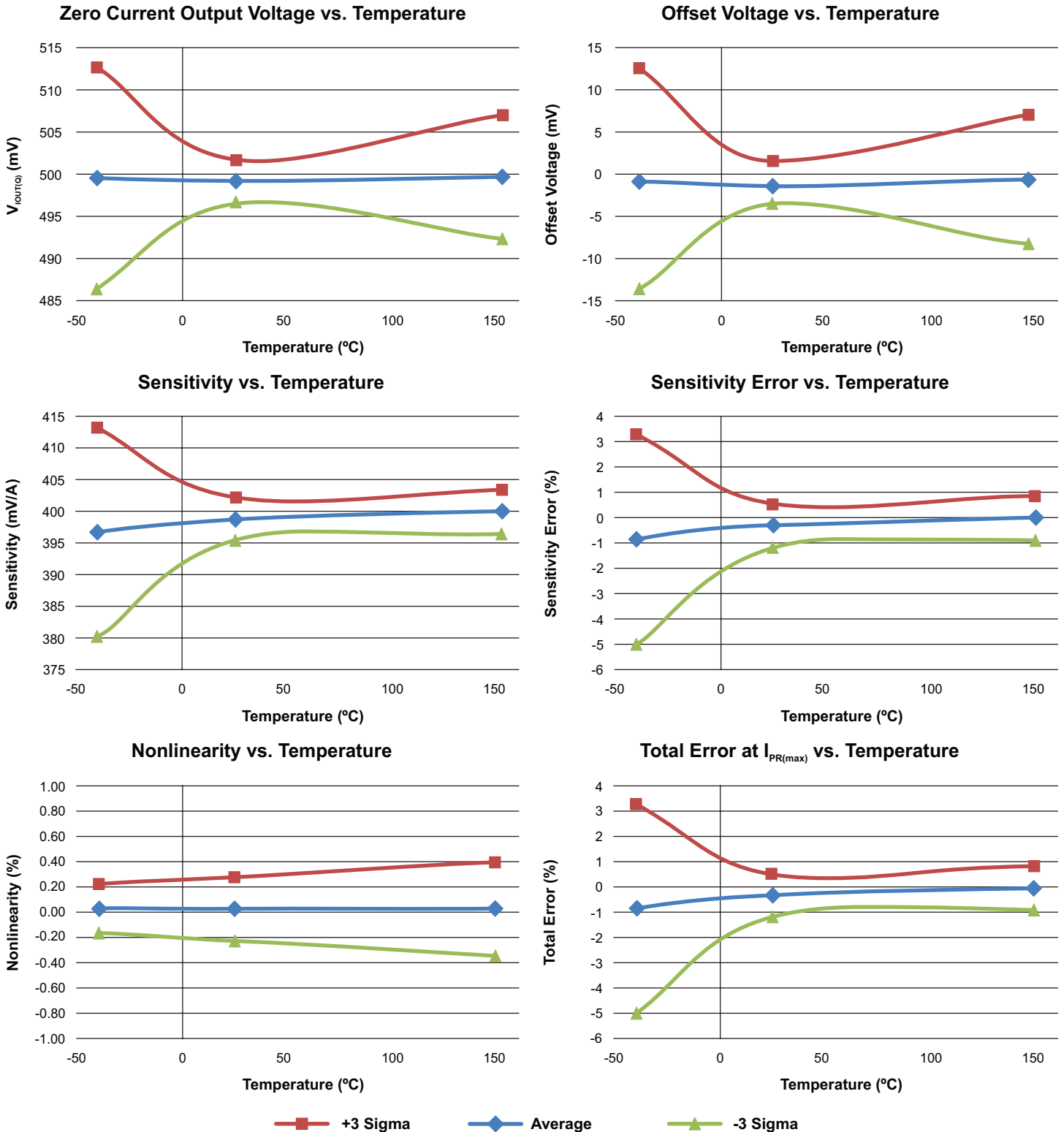

xLLCTR-10AB

Zero Current Output Voltage vs. Temperature

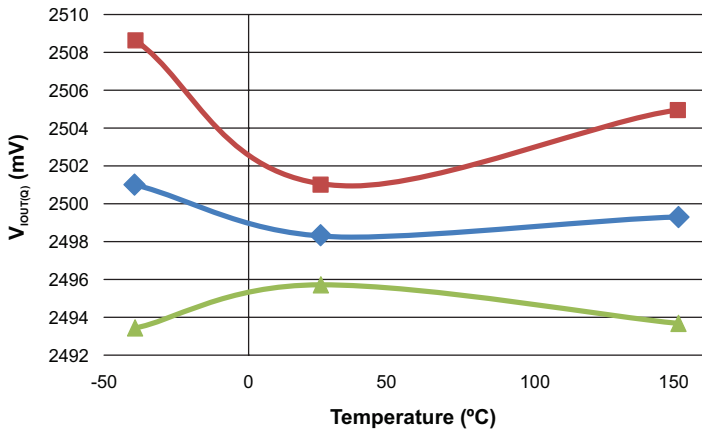

Offset Voltage vs. Temperature

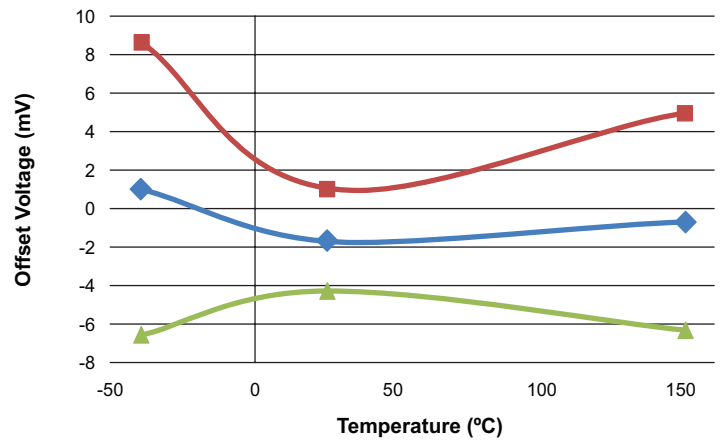

Sensitivity vs. Temperature

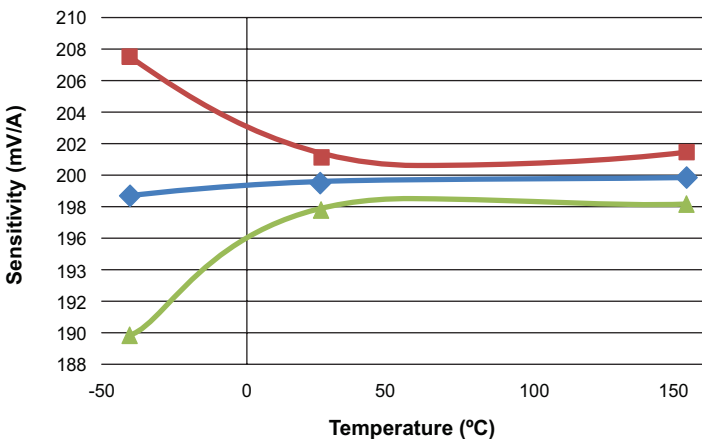

Sensitivity Error vs. Temperature

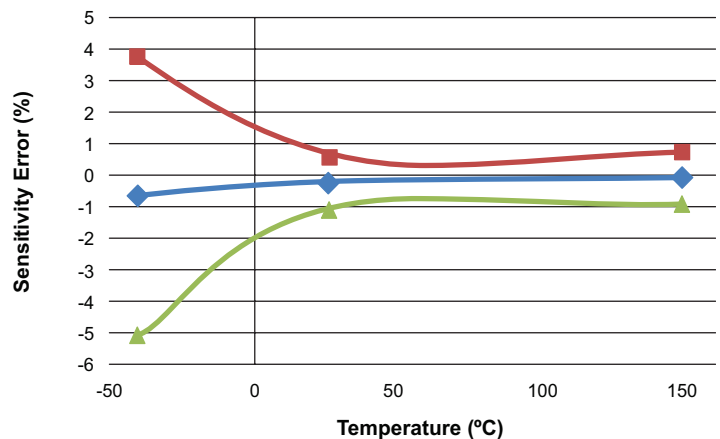

Nonlinearity vs. Temperature

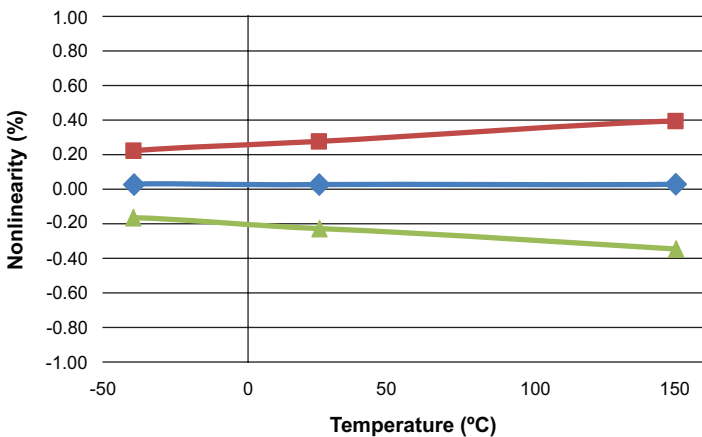

Total Error at $I_{PR(max)}$ vs. Temperature

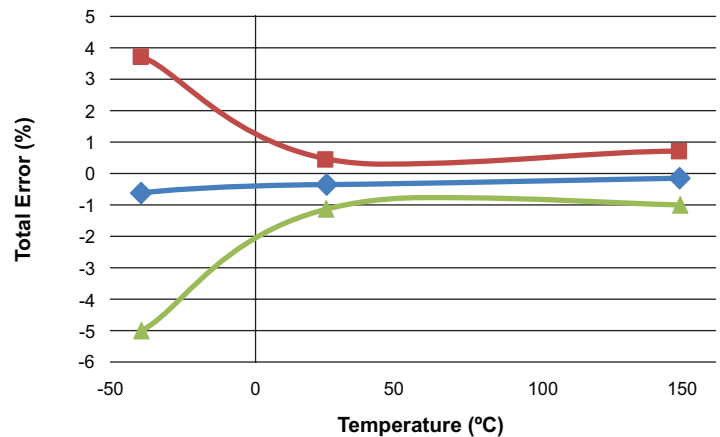

■ +3 Sigma
 ◆ Average
 ▲ -3 Sigma

xLLCTR-20AU

Zero Current Output Voltage vs. Temperature

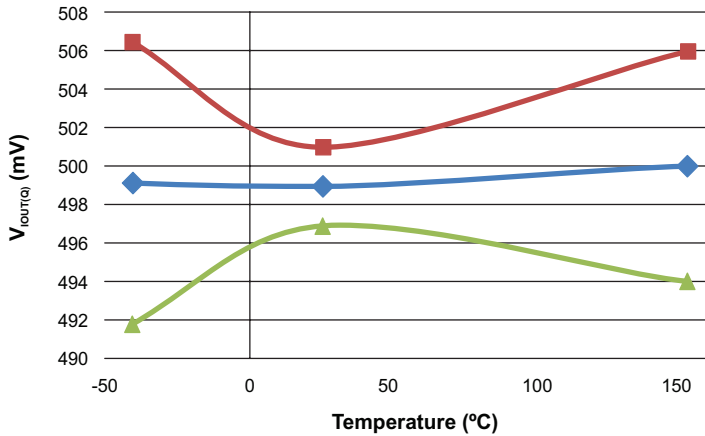

Offset Voltage vs. Temperature

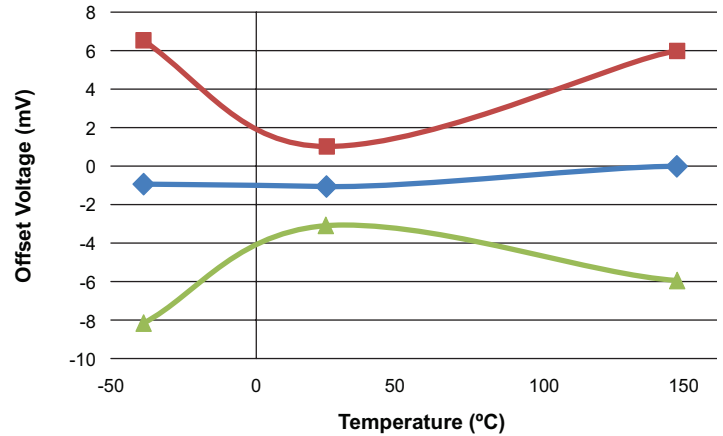

Sensitivity vs. Temperature

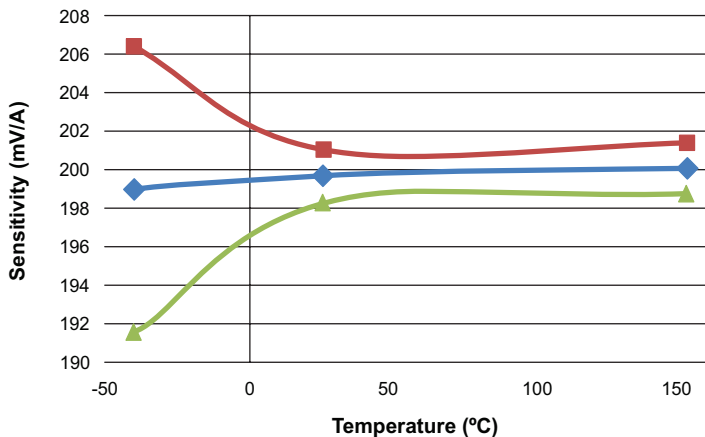

Sensitivity Error vs. Temperature

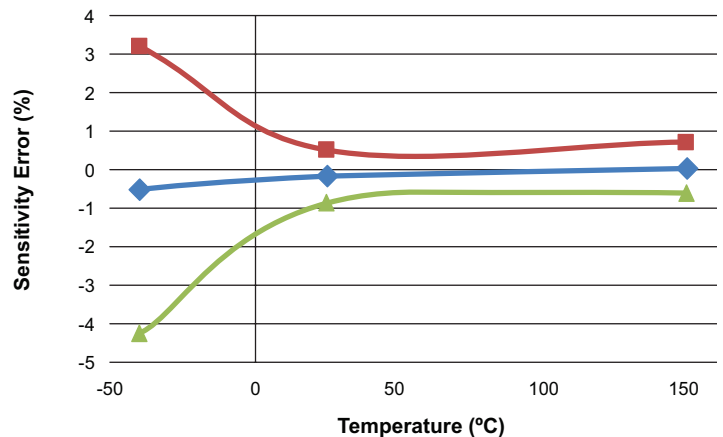

Nonlinearity vs. Temperature

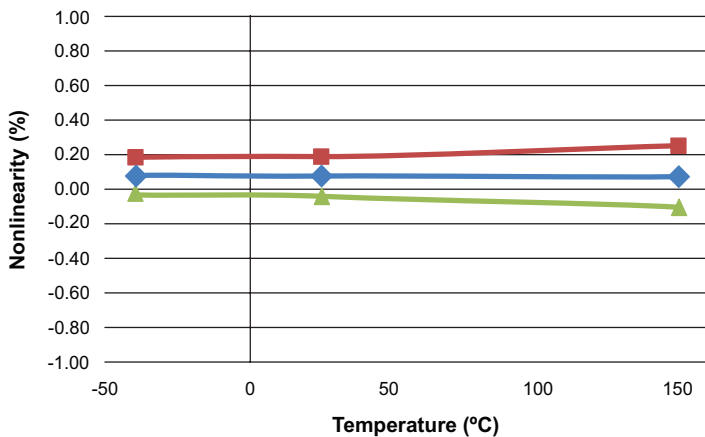

Total Error at $I_{PR(max)}$ vs. Temperature

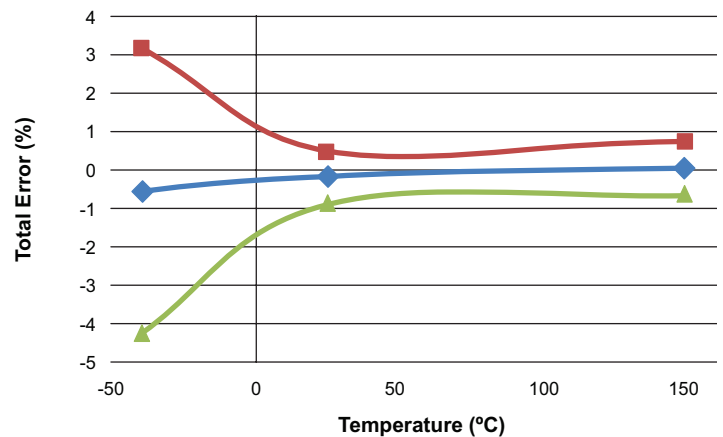

■ +3 Sigma
 ◆ Average
 ▲ -3 Sigma

xLLCTR-20AB

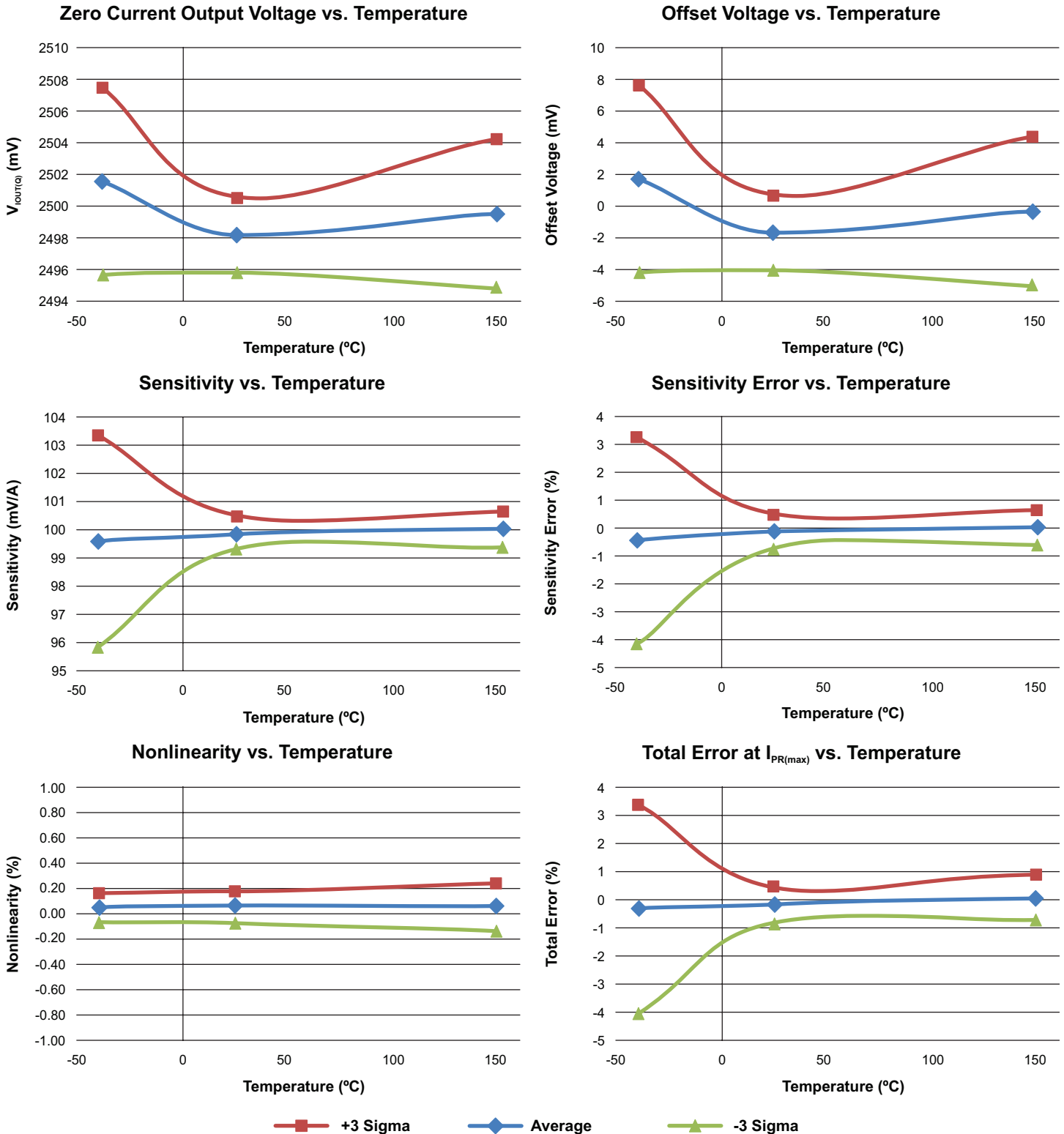

xLLCTR-30AU

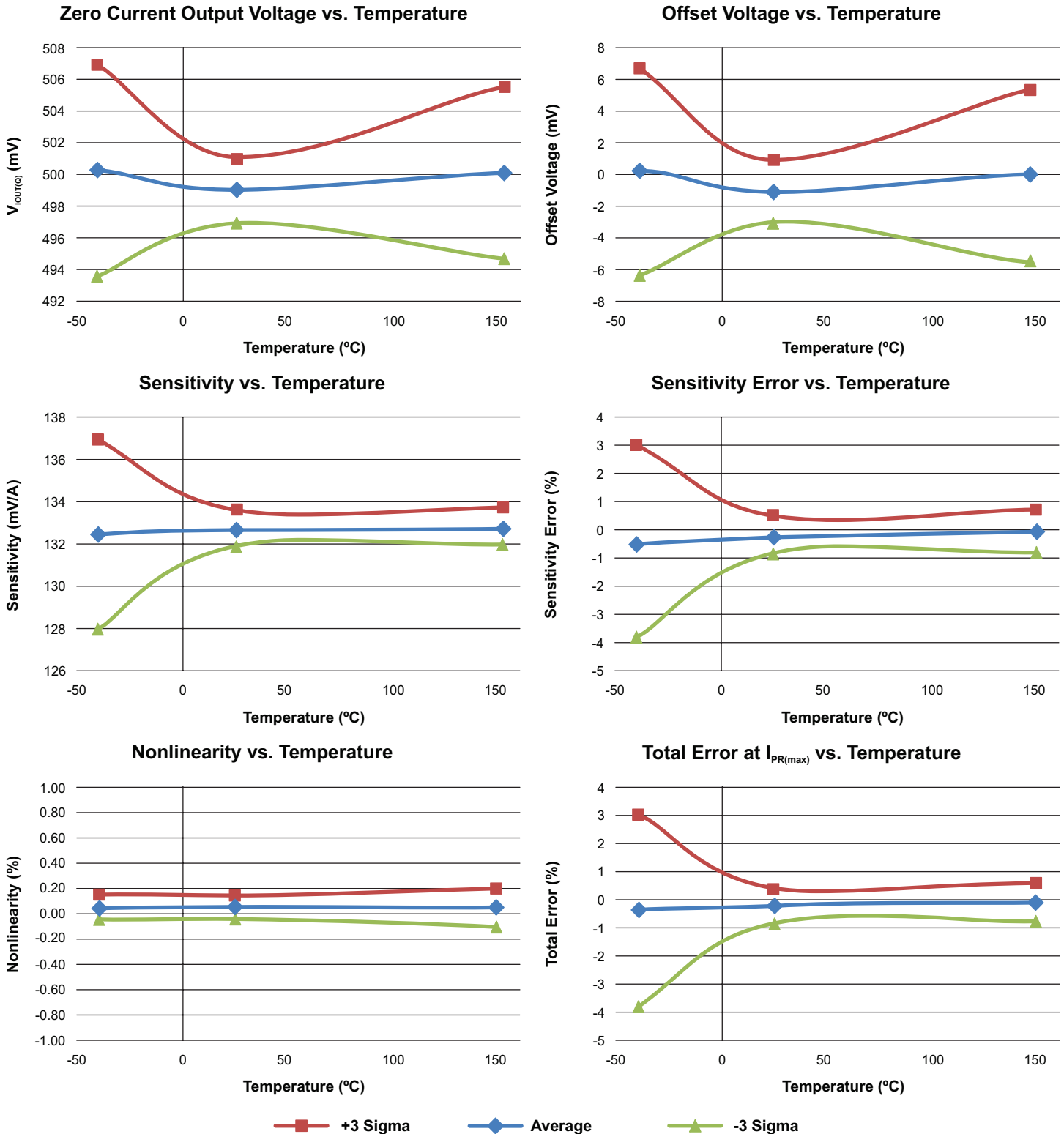

xLLCTR-30AB

Zero Current Output Voltage vs. Temperature

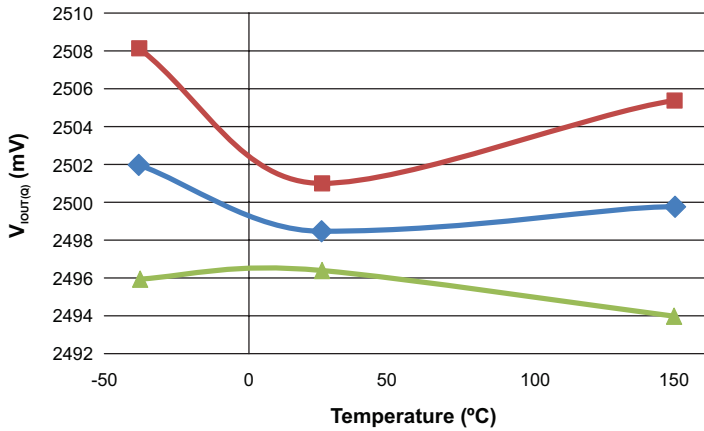

Offset Voltage vs. Temperature

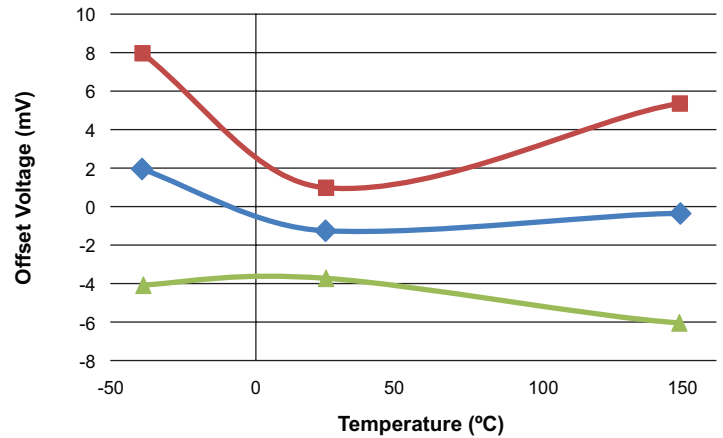

Sensitivity vs. Temperature

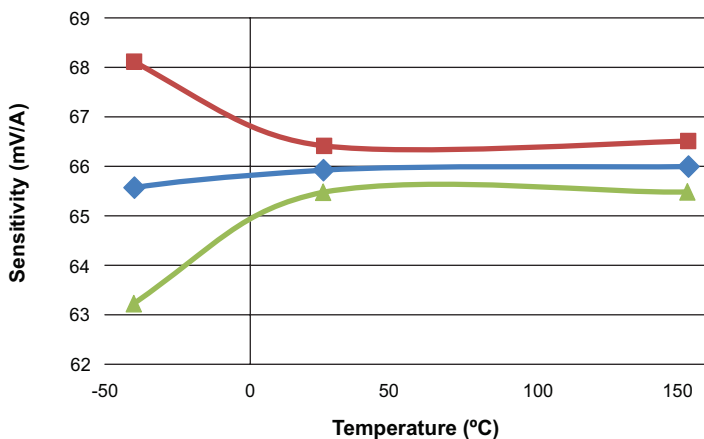

Sensitivity Error vs. Temperature

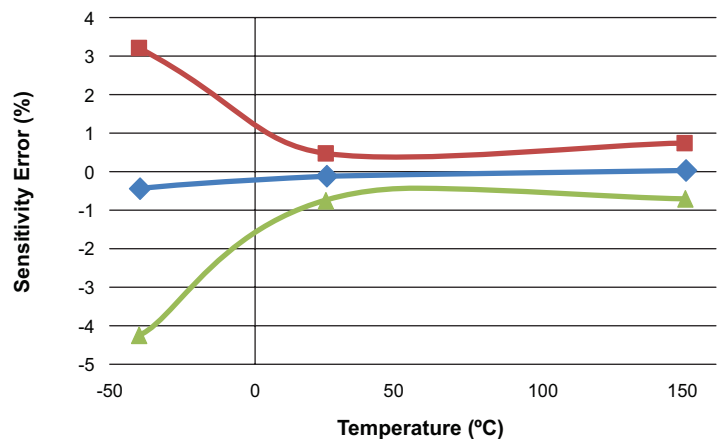

Nonlinearity vs. Temperature

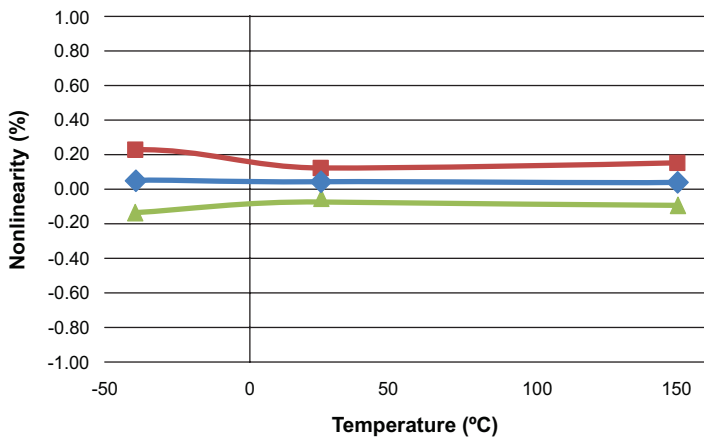

Total Error at $I_{PR(max)}$ vs. Temperature

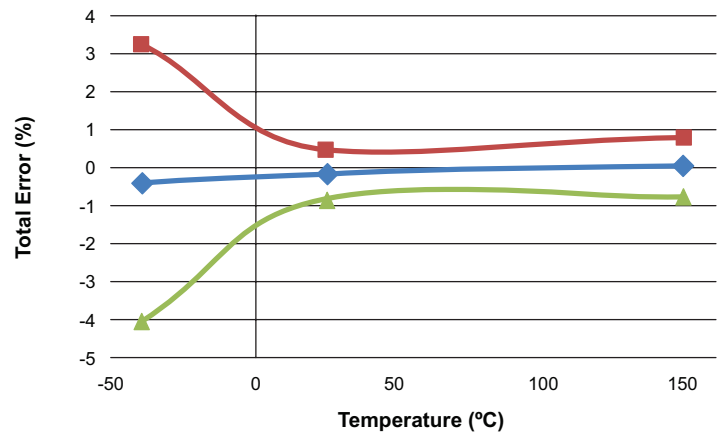

■ +3 Sigma
 ◆ Average
 ▲ -3 Sigma

APPLICATION INFORMATION

Estimating Total Error vs. Sensed Current

The Performance Characteristics tables give distribution (± 3 sigma) values for Total Error at $I_{PR(max)}$; however, one often wants to know what error to expect at a particular current. This can be estimated by using the distribution data for the components of Total Error, Sensitivity Error, and Offset Voltage. The ± 3 sigma value for Total Error (E_{TOT}) as a function of the sensed current (I_p) is estimated as:

$$E_{TOT}(I_p) = \sqrt{E_{SENS}^2 + \left(\frac{100 \times V_{OE}}{Sens \times I_p}\right)^2}$$

Here, E_{SENS} and V_{OE} are the ± 3 sigma values for those error terms. If there is an average sensitivity error or average offset voltage, then the average Total Error is estimated as:

$$E_{TOT_{AVG}}(I_p) = E_{SENS_{AVG}} + \frac{100 \times V_{OE_{AVG}}}{Sens \times I_p}$$

The resulting total error will be a sum of E_{TOT} and $E_{TOT_{AVG}}$. Using these equations and the 3 sigma distributions for Sensitivity Error and Offset Voltage, the Total Error versus sensed current (I_p) is below for the ACS724LLCTR-20AB. As expected, as one goes towards zero current, the error in percent goes towards infinity due to division by zero.

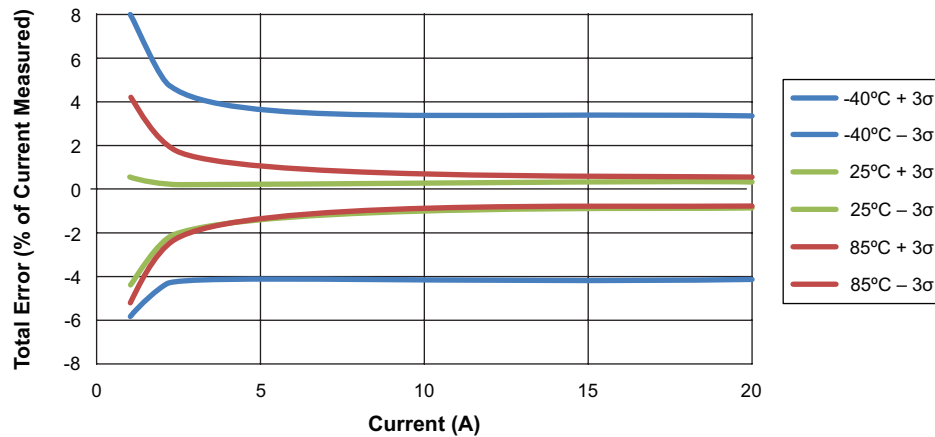

Figure 1: Predicted Total Error as a Function of the Sensed Current for the ACS724LLCTR-20AB

DEFINITIONS OF ACCURACY CHARACTERISTICS

Sensitivity (Sens). The change in sensor IC output in response to a 1 A change through the primary conductor. The sensitivity is the product of the magnetic circuit sensitivity (G/A) (1 G = 0.1 mT) and the linear IC amplifier gain (mV/G). The linear IC amplifier gain is programmed at the factory to optimize the sensitivity (mV/A) for the full-scale current of the device.

Nonlinearity (E_{LIN}). The nonlinearity is a measure of how linear the output of the sensor IC is over the full current measurement range. The nonlinearity is calculated as:

$$E_{LIN} = \left\{ 1 - \left[\frac{V_{IOUT}(I_{PR(max)}) - V_{IOUT(Q)}}{2 \cdot V_{IOUT}(I_{PR(max)/2}) - V_{IOUT(Q)}} \right] \right\} \cdot 100(\%)$$

where $V_{IOUT}(I_{PR(max)})$ is the output of the sensor IC with the maximum measurement current flowing through it and $V_{IOUT}(I_{PR(max)/2})$ is the output of the sensor IC with half of the maximum measurement current flowing through it.

Zero-Current Output Voltage ($V_{IOUT(Q)}$). The output of the sensor when the primary current is zero. For a unipolar supply voltage, it nominally remains at $0.5 \times V_{CC}$ for a bidirectional device and $0.1 \times V_{CC}$ for a unidirectional device. For example, in the case of a bidirectional output device, $V_{CC} = 5 \text{ V}$ translates into $V_{IOUT(Q)} = 2.5 \text{ V}$. Variation in $V_{IOUT(Q)}$ can be attributed to the resolution of the Allegro linear IC quiescent voltage trim and thermal drift.

Offset Voltage (V_{OE}). The deviation of the device output from its ideal quiescent value of $0.5 \times V_{CC}$ (bidirectional) or $0.1 \times V_{CC}$ (unidirectional) due to nonmagnetic causes. To convert this voltage to amperes, divide by the device sensitivity, Sens.

Total Output Error (E_{TOT}). The difference between the current measurement from the sensor IC and the actual current (I_p), relative to the actual current. This is equivalent to the difference between the ideal output voltage and the actual output voltage, divided by the ideal sensitivity, relative to the current flowing through the primary conduction path:

$$E_{TOT}(I_p) = \frac{V_{IOUT_ideal}(I_p) - V_{IOUT}(I_p)}{Sens_{ideal}(I_p) \cdot I_p} \cdot 100(\%)$$

The Total Output Error incorporates all sources of error and is a function of I_p . At relatively high currents, E_{TOT} will be mostly due to sensitivity error, and at relatively low currents, E_{TOT} will be mostly due to Offset Voltage (V_{OE}). In fact, at $I_p = 0$, E_{TOT} approaches infinity due to the offset. This is illustrated in Figures 1 and 2. Figure 1 shows a distribution of output voltages versus I_p at 25°C and across temperature. Figure 2 shows the corresponding E_{TOT} versus I_p .

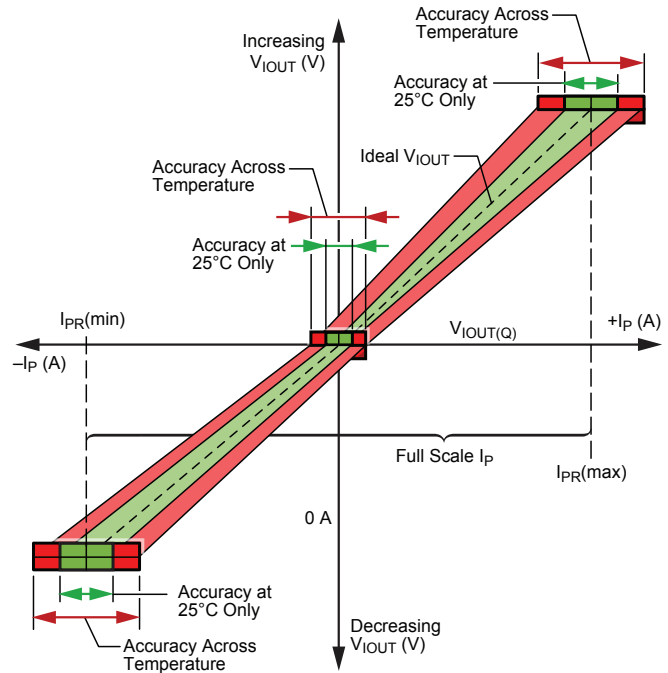

Figure 1: Output Voltage versus Sensed Current

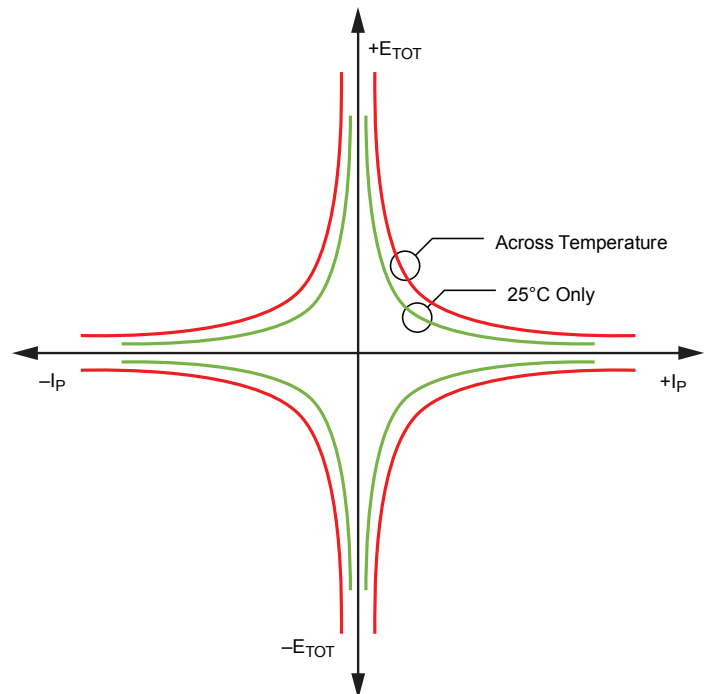

Figure 2: Total Output Error versus Sensed Current

Sensitivity Ratiometry Coefficient (SENS_RAT_COEF). The coefficient defining how the sensitivity scales with V_{CC} . The ideal coefficient is 1, meaning the sensitivity scales proportionally with V_{CC} . A 10% increase in V_{CC} results in a 10% increase in sensitivity. A coefficient of 1.1 means that the sensitivity increases by 10% more than the ideal proportionality case. This means that a 10% increase in V_{CC} results in an 11% increase in sensitivity. This relationship is described by the following equation:

$$Sens(V_{CC}) = Sens(5 V) \left[1 + \frac{(V_{CC} - 5 V) \cdot SENS_RAT_COEF}{5 V} \right]$$

This can be rearranged to define the sensitivity ratiometry coefficient as:

$$SENS_RAT_COEF = \left[\frac{Sens(V_{CC})}{Sens(5 V)} - 1 \right] \cdot \frac{5 V}{(V_{CC} - 5 V)}$$

Zero-Current Output Ratiometry Coefficient (QVO_RAT_COEF). The coefficient defining how the zero-current output voltage scales with V_{CC} . The ideal coefficient is 1, meaning the output voltage scales proportionally with V_{CC} , always being equal to $V_{CC}/2$. A coefficient of 1.1 means that the zero-current output voltage increases by 10% more than the ideal proportionality case. This means that a 10% increase in V_{CC} results in an 11% increase in the zero-current output voltage. This relationship is described by the following equation:

$$VIOUTQ(V_{CC}) = VIOUTQ(5 V) \left[1 + \frac{(V_{CC} - 5 V) \cdot QVO_RAT_COEF}{5 V} \right]$$

This can be rearranged to define the zero-current output ratiometry coefficient as:

$$QVO_RAT_COEF = \left[\frac{VIOUTQ(V_{CC})}{VIOUTQ(5 V)} - 1 \right] \cdot \frac{5 V}{(V_{CC} - 5 V)}$$

DEFINITIONS OF DYNAMIC RESPONSE CHARACTERISTICS

Power-On Time (t_{PO}). When the supply is ramped to its operating voltage, the device requires a finite time to power its internal components before responding to an input magnetic field. Power-On Time, t_{PO} , is defined as the time it takes for the output voltage to settle within $\pm 10\%$ of its steady-state value under an applied magnetic field, after the power supply has reached its minimum specified operating voltage, $V_{CC(min)}$, as shown in the chart at right.

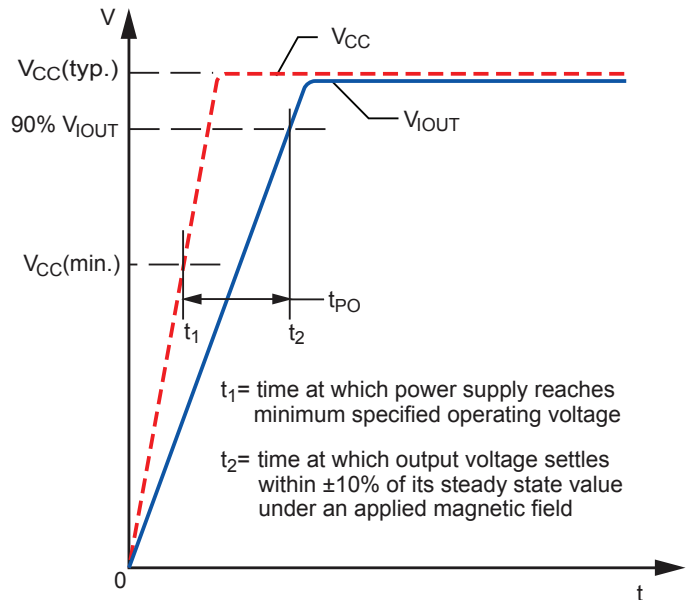

Figure 3: Power-On Time (t_{PO})

Rise Time (t_r). The time interval between a) when the sensor IC reaches 10% of its full-scale value, and b) when it reaches 90% of its full-scale value. The rise time to a step response is used to derive the bandwidth of the current sensor IC, in which $f(-3 \text{ dB}) = 0.35/t_r$. Both t_r and $t_{RESPONSE}$ are detrimentally affected by eddy-current losses observed in the conductive IC ground plane.

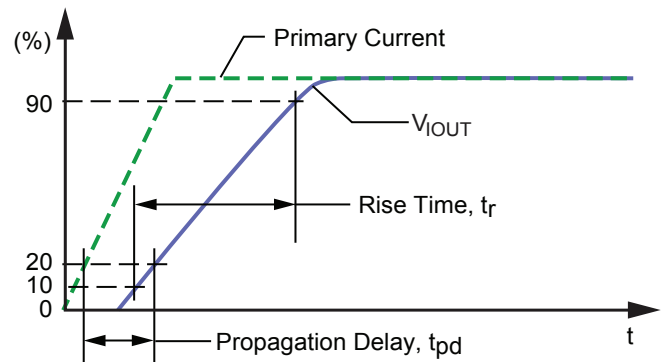

Figure 4: Rise Time (t_r) and Propagation Delay (t_{pd})

Response Time ($t_{RESPONSE}$). The time interval between a) when the primary current signal reaches 90% of its final value, and b) when the device reaches 90% of its output corresponding to the applied current.

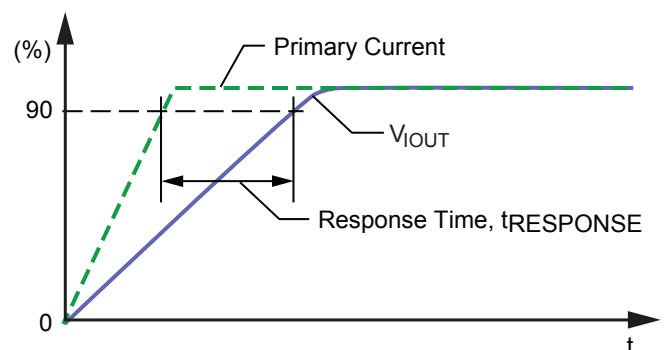

Figure 5: Response Time ($t_{RESPONSE}$)

PACKAGE OUTLINING DRAWING

For Reference Only – Not for Tooling Use

(Reference MS-012AA)

Dimensions in millimeters – NOT TO SCALE

Dimensions exclusive of mold flash, gate burrs, and dambar protrusions
Exact case and lead configuration at supplier discretion within limits shown

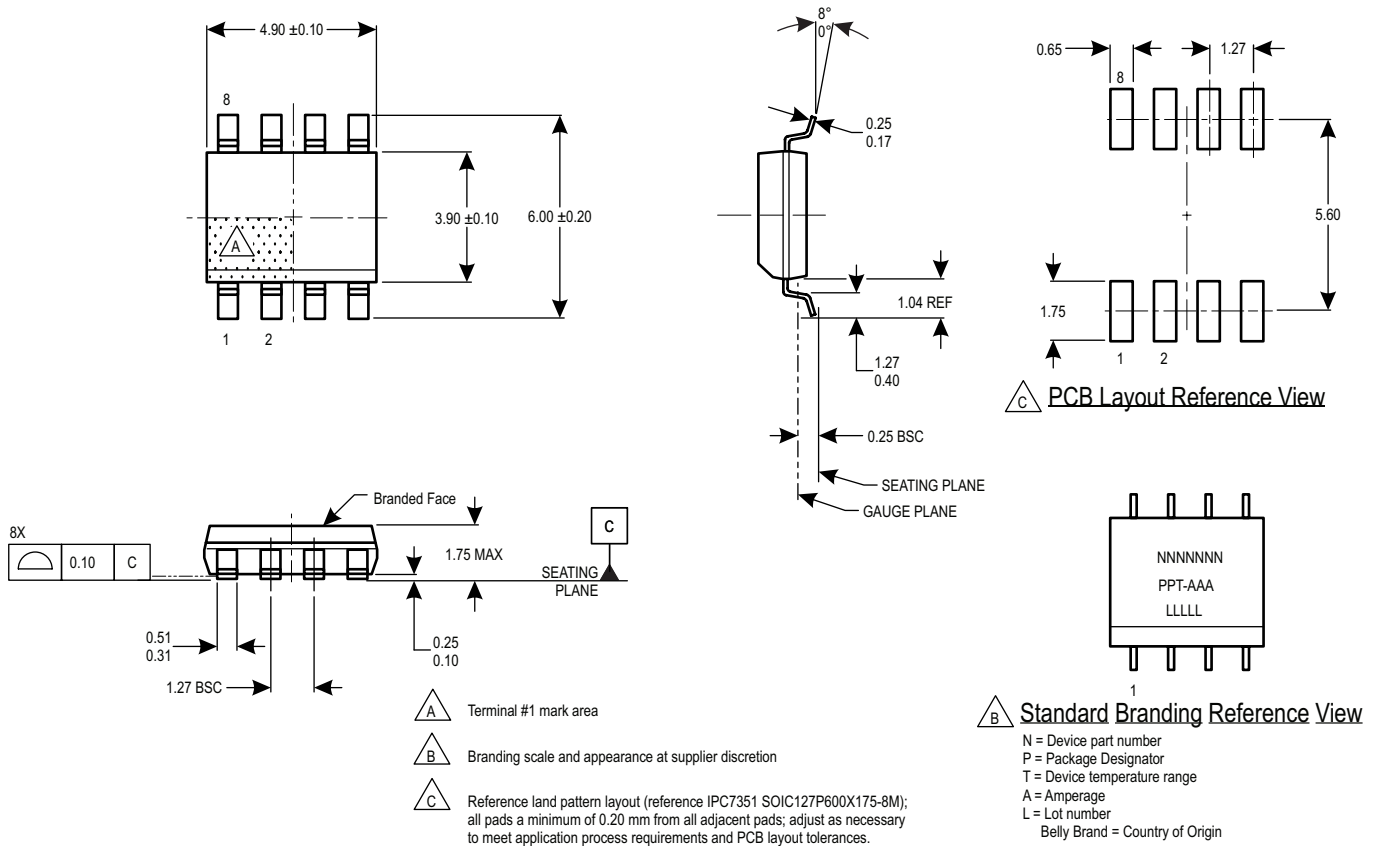

Figure 6: Package LC, 8-pin SOICN

Document Revision History

| Revision | Change | Pages | Responsible | Date |
|----------|---|-------|-------------------------|------------------|
| - | Added Characteristic Performance graphs and Application Information to Preliminary draft to create Final draft | All | A. Latham | January 16, 2015 |
| 1 | Corrected Features and Benefits | 2 | A. Latham | June 19, 2015 |
| 2 | Added ACS724LLCTR-50AB-T variant with electrical characteristics | 2, 9 | A. Latham | June 23, 2015 |
| 3 | Corrected Characteristic Performance graph legends; updated Lifetime Drift Characteristics and added Error Over Lifetime electrical characteristics | 6-18 | A. Latham, S. Milano | August 12, 2015 |
| 4 | Added ACS724LLCTR-05AB-T variant with electrical characteristics | 2, 6 | W. Bussing | August 8, 2016 |

Copyright ©2016, Allegro MicroSystems, LLC

Allegro MicroSystems, LLC reserves the right to make, from time to time, such departures from the detail specifications as may be required to permit improvements in the performance, reliability, or manufacturability of its products. Before placing an order, the user is cautioned to verify that the information being relied upon is current.

Allegro's products are not to be used in any devices or systems, including but not limited to life support devices or systems, in which a failure of Allegro's product can reasonably be expected to cause bodily harm.

The information included herein is believed to be accurate and reliable. However, Allegro MicroSystems, LLC assumes no responsibility for its use; nor for any infringement of patents or other rights of third parties which may result from its use.

For the latest version of this document, visit our website:

www.allegromicro.com



X-ON Electronics

Largest Supplier of Electrical and Electronic Components

Click to view similar products for [Industrial Current Sensors](#) category:

Click to view products by [Allegro](#) manufacturer:

Other Similar products are found below :

[CSNS181](#) [S28S500D24ZM](#) [CSNS300M-001](#) [L05Z800S15](#) [5SHT-151-E](#) [5SHT-500-E](#) [T60404-B4658-X030](#) [T60404-B4658-X029](#) [SAO-Q1N](#) [SAO-Q2N](#) [CSNS300F-002](#) [CSCA0075A000U12J01](#) [SAO-S1N](#) [L34S1T5D15T](#) [L34S500D15T](#) [L34S1T0D15T](#) [CSNS300M-500](#) [LA200-P](#) [ACS724LLCTR-10AB-T](#) [ACS711KEXLT-15AB-T](#) [20310200202](#) [LCS10T12](#) [20320500101](#) [20310508201](#) [CCT354571-300-24-00](#) [LCSC10T12](#) [20320300101](#) [S29S1T0D24Z](#) [CCT272440-80-10-02](#) [DCSA20](#) [S21S180D15JN](#) [L31S300S05FS](#) [T60404-N4644-X021](#) [ECSL61AH](#) [ISB-300-A-802](#) [ISB-300-A-604](#) [ISB-175-A-802](#) [ISB-175-A-800](#) [ISB-175-A-604](#) [ISB-100-A-802](#) [LPMG12](#) [ECS41BC](#) [ECS41BD](#) [SAO-S5N](#) [DCSA50](#) [ECS21BC](#) [ACS726LLFTR-20B-T](#) [A-CS010B](#) [A-CS050B](#) [A-CS100B](#)