

DURACELL®

DURALOCK
POWER PRESERVE™



ULTRA POWER

MX1500

Size: AA (LR6)

Alkaline-Manganese Dioxide Battery

Zn/MnO₂



Nominal voltage	1.5 V
Impedance	81 m-ohm @ 1 kHz
Typical weight	24 g (0.8 oz)
Typical volume	8.4 cm ³ (0.5 in ³)
Terminals	Flat
Storage temperature range	5°C to 30°C (41°F to 86°F)
Operating temperature range	-20°C to 54°C (-4°F to 130°F)
Designation	IEC: LR6

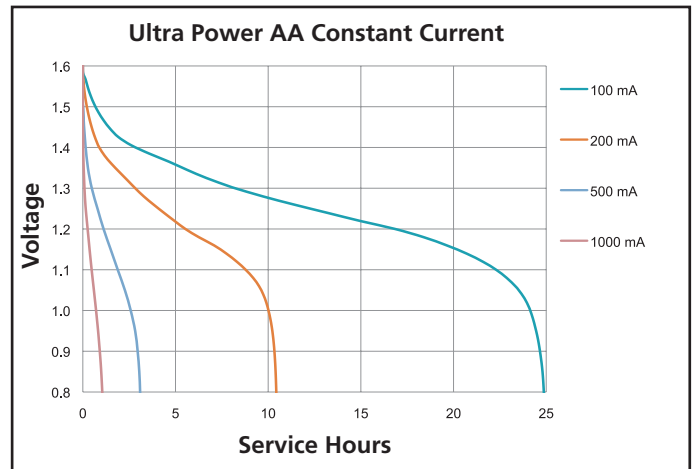
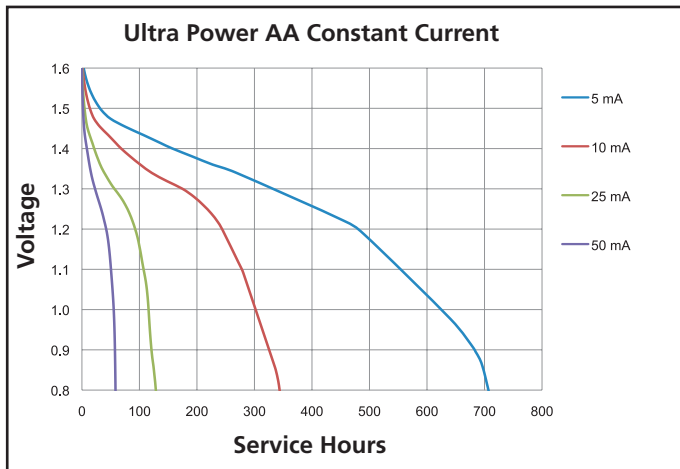
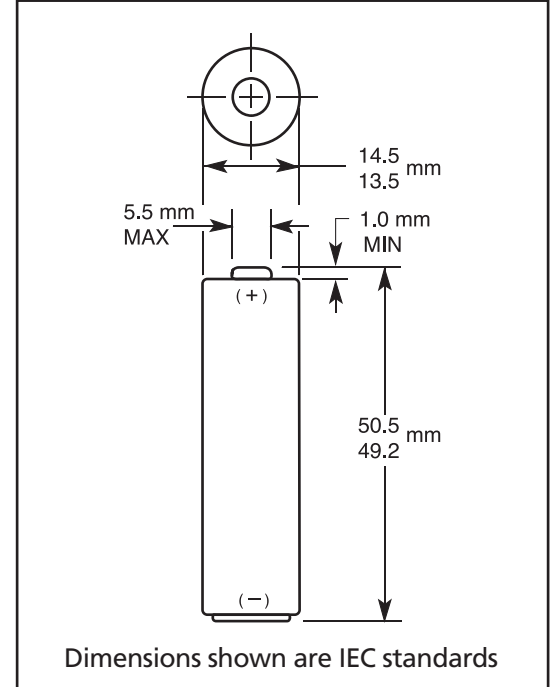

DURACELL®

BATTERIES

Berkshire Corporate Park
Bethel, CT. 06801 U.S.A.
Telephone: Toll-free 1-800-544-5454
www.duracell.com

Delivered capacity is dependent on the applied load, operating temperature and cut-off voltage. Please refer to the charts and discharge data shown for examples of the energy/service life that the battery will provide for various load conditions.

DURACELL®

DURALOCK
POWER PRESERVE™



ULTRA POWER

MX1500

Size: AA (LR6)

Alkaline-Manganese Dioxide Battery

Zn/MnO₂

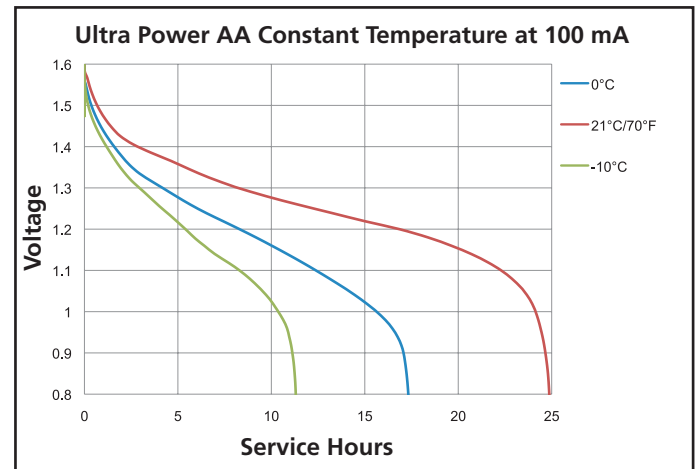
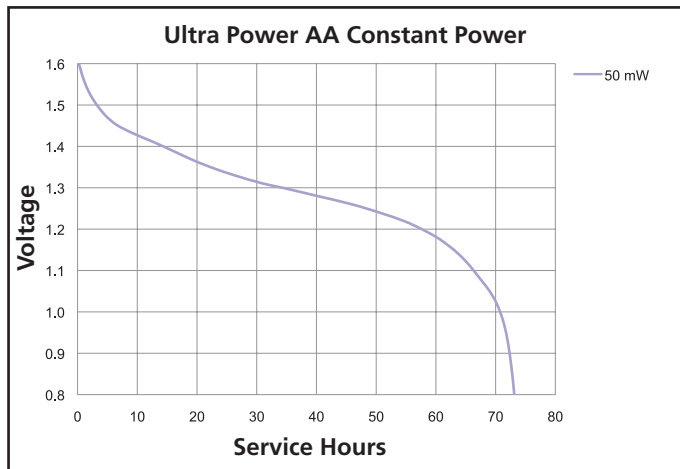
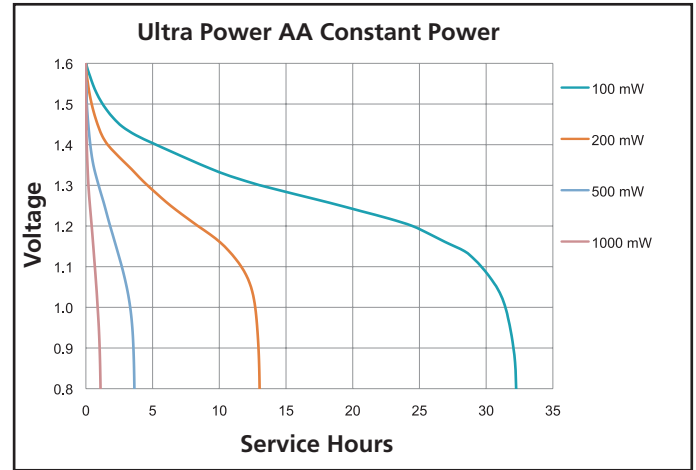
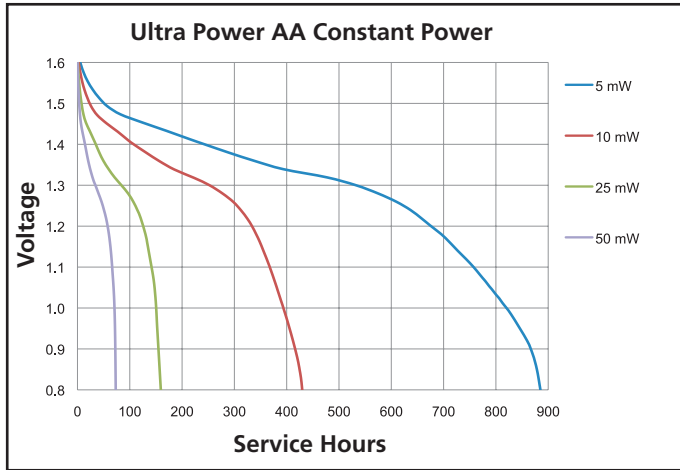

Delivered capacity is dependent on the applied load, operating temperature and cut-off voltage. Please refer to the charts and discharge data shown for examples of the energy/service life that the battery will provide for various load conditions.

DURACELL®

BATTERIES

Berkshire Corporate Park
Bethel, CT. 06801 U.S.A.
Telephone: Toll-free 1-800-544-5454
www.duracell.com

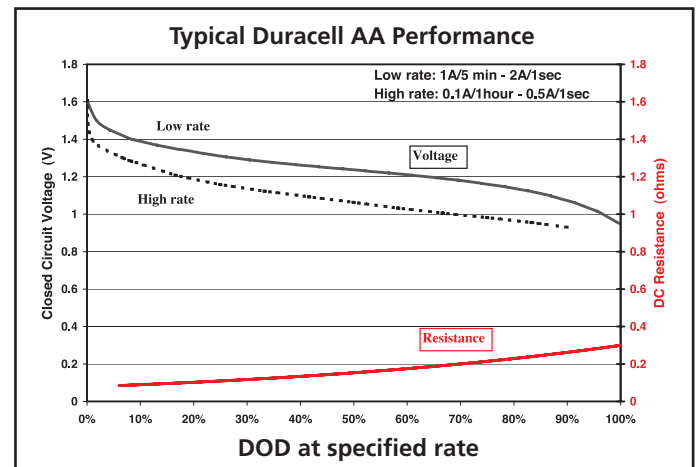

This data is subject to change. Performance information is typical. Contact Duracell for the latest information.

MX15UPWE0613

X-ON Electronics

Largest Supplier of Electrical and Electronic Components

Click to view similar products for [duracell](#) manufacturer:

Other Similar products are found below :

[DL1620B](#) [MS76B](#) [LR20/D/MN1300\(K2\)](#) [DA146](#) [MN2400B4](#) [15035031 M3 C 2PK](#) [10 ET](#) [13 ET](#) [LR20/D \(K2\) PLUS POWER](#)

[LR6/AA/MN1500\(K2\) ECONOMY PACK](#) [LR6/AA/MN1500\(K8\) ECONOMY PACK](#) [CEF27 2XAA 2XAAA](#) [DL223AB](#) [75044300](#) [PC1400](#)

[MN2400](#) [LR43](#) [PC134A](#) [CEF14 2XAA 2XAAA](#) [ACCU 9V1](#) [5000394002883](#) [MN1604](#) [DRC5906](#) [PC1604](#) [DRC5902](#) [15035025 M3 PP3](#)

[DRS5964](#) [DRO5941](#) [DRC5908](#) [DRN5924](#) [5000394019126](#) [DRP6116](#) [5000394105522](#) [DRG5945](#) [ACCU D2](#) [5000394082991](#) [DRO5940](#)

[DRP5953](#) [5000394020092](#) [DRC5904](#) [DRC5907](#) [DR5030A](#) [DRC5905](#) [DRG5944](#) [DRP5954](#) [DRACUSB3-EU](#) [DRC5909](#) [DRF5982](#)

[DRP5952](#) [395](#)