

SPECIFICATIONS 规格
 CURRENT RATING 电流额定值: 3 Amp
 INSULATION RESISTANCE 绝缘电阻值: 1000 MΩ min.
 DIELECTRIC WITHSTANDING 耐电压: 500V AC/minute
 CONTACT RESISTANCE 接触电阻值: 20 mΩ MAX.
 OPERATING TEMPERATURE 工作温度: -40°C TO +105°C
 PLATING MATERIAL 端子物料: PHOSPHOR BRONZE
 CONTACT AREA 接触面积: 50µ"~100µ" NICKEL UNDERPLATE, FOR PLATING
 SEE ORDERING GRID.
 INSULATOR MATERIAL 绝缘体物料: POLYESTER 聚酯, LCP 30% GLASS FILLED,
 SOLDERING PROCESS 可焊性:
 IR REFLOW 回流焊: 260°C FOR 10 SEC.
 MANUAL SOLDER 人工焊接: 350°C FOR 3-5 SEC

NOTES 备注:
 BG301 - SELECT 4.00mm PIN LENGTH 选择 4.00mm 引脚长度, BG303, BG304 & BG305
 STANDARD BLACK VERSION OF BG306 IS BG125
 BG306 的标准黑色塑胶版本为料号为 BG125

By	ASE	AJO
DETAIL	DRAWING SELECTABLE	PACKING ADDED
REV	A	18/04/12
DATE	B	16/07/12
	C	18/06/13



Tolerances	
(Except as noted)	
Dimensions in mm	
Description:-	
X.X ± 0.30	
X.XX ± 0.20	

Part Number:-	BG306
Date:-	18 APR 12
Scale	NTS
Revision	C
Material	See Note
Drawn by	ASE
E & OE	
Sheet No.	1/1

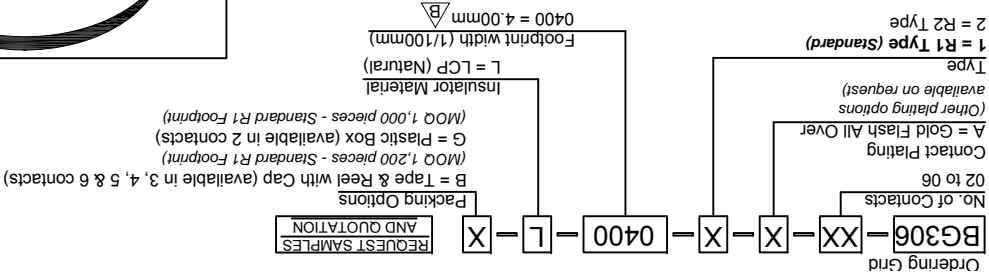

CONTACTS		DIMENSIONS	
A	B	2.54	5.08
3	7.62	5.08	7.62
4	10.16	7.62	10.16
5	12.70	10.16	12.70
6	15.24	12.70	15.24

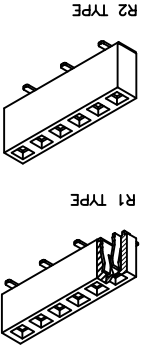

White Lite

GCT

www.gct.co

THIS DRAWING IS CONFIDENTIAL AND MUST NOT BE COPIED OR DISCLOSED WITHOUT WRITTEN CONSENT
2.54mm PITCH PIN SOCKET, SINGLE ROW, VERTICAL, TOP ENTRY, SURFACE MOUNT, NATURAL LCP

3 PIN - For packaging information, please contact GCT

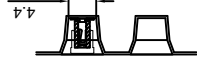
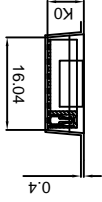
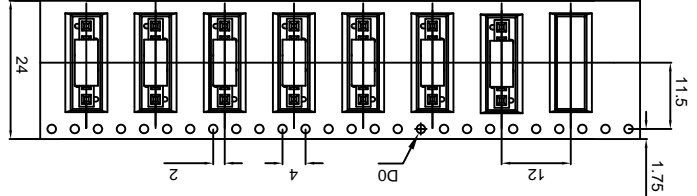
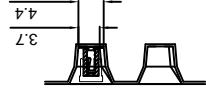
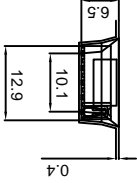
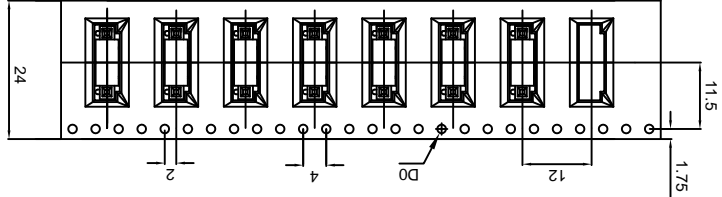
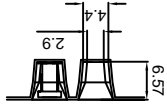
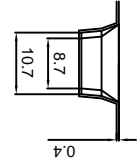
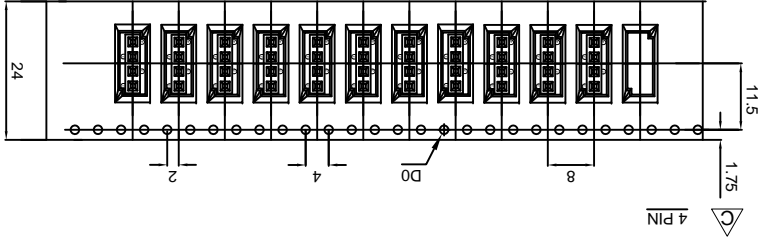

PINS	UNITS/REEL	REELS PER CARTON	CARTON	TOTAL CARRIER TAPE LENGTH
4	1200 PCS	8	9.600	12.7 m
5	1200 PCS	8	9.600	15.1 m
6	1200 PCS	8	9.600	15.1 m

By	ASE	AJO	ASE	AJO
DETAIL	RELEASE	SELECTABLE	WIDTH REMOVED	DRAWING ADDED
REV	A	B	C	
DATE	18/04/12	16/07/12	18/06/13	

ROHS
2011/65/EU
COMPLIANT

Tolerances	
(Except as noted)	
Dimensions in mm	
X ± 0.30	X ° ± 4.0°
X.X ± 0.20	X.X ° ± 3.0°
X.XX ± 0.30	X.XX ° ± 2.0°
X.XXX ± 0.20	X.XXX ° ± 1.0°

Part Number-	Date:-
BG306	18 APR 12

THIS DRAWING IS CONFIDENTIAL AND MUST NOT BE COPIED OR DISCLOSED WITHOUT WRITTEN CONSENT

Scale	Revision	Material	See Note	ASE	E & OE	Sheet No.
NTS	C					1/1

White Lite
GCT
www.gct.co

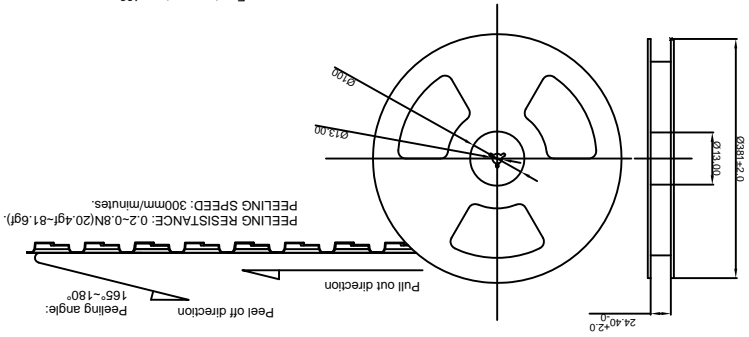
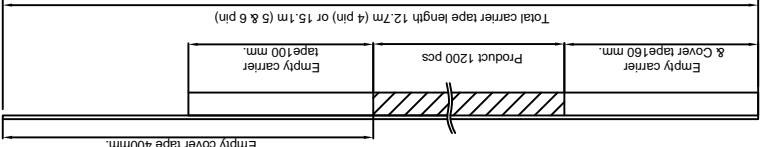
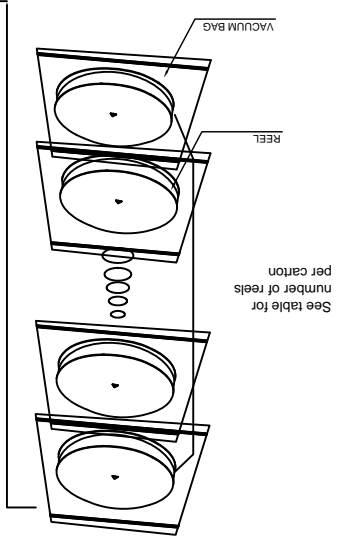
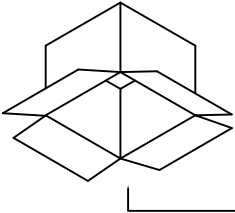
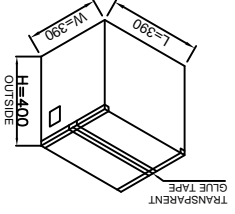

X-ON Electronics

Largest Supplier of Electrical and Electronic Components

Click to view similar products for [FFC & FPC Connectors](#) category:

Click to view products by [GCT](#) manufacturer:

Other Similar products are found below :

[HFW11R-1STE1H1LF](#) [FH29B-100S-0.2SHW\(99\)](#) [FA5S008HP1](#) [FH29B-120S-0.2SHW\(99\)](#) [FH29B-80S-0.2SHW\(99\)](#) [FHS-16](#) [FPH-2022G](#)
[52610-1075](#) [52610-1275](#) [52610-1934](#) [XF3M\(1\)-1415-1B-R100](#) [501864-3091-TR225](#) [0525594033](#) [086210010340800](#) [086222026001800](#)
[52271-2869-CUT-TAPE](#) [62674-201121DLF](#) [62684-36210E9ALF](#) [52610-1675](#) [52746-1671-TR250](#) [10051922-2810EHLF](#) [6-520415-9](#)
[BD021-09A-A1-0350-0200-0550-LD](#) [SFV6R-1STE9HLF](#) [XF3M-2915-1B-R100](#) [1658549-1](#) [62674-221121ALF](#) [46214008010800](#)
[046298003000883](#) [151660622](#) [842-816-2630-035](#) [AYF530665TA](#) [AYF351525](#) [046296011930846+](#) [AYF352325A](#) [046254020000800+](#)
[FH19C-13S-0.5SH\(99\)](#) [FH39J-51S-0.3SHW\(99\)](#) [AYF355125A](#) [AYF530365TA](#) [FH29B-44S-0.2SHW\(99\)](#) [SFW5R-2STAE9LF](#) [AYF351125A](#)
[AYF350725A](#) [62684-502100AHLF](#) [FH39-61S-0.3SHW\(99\)](#) [AYF414035A](#) [10064555-172520HLF](#) [AYF212335A](#) [504754-2500](#)