

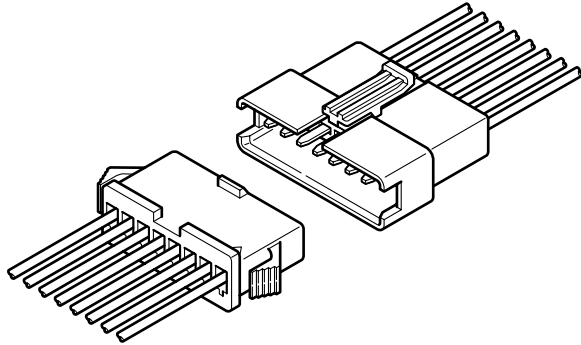

# SM CONNECTOR

2.5mm pitch/Disconnectable Crimp style wire-to-wire connectors



**The SM series are 2.5mm pitch, wire-to-wire connectors that perform reliably in high-density, small current applications.**

- High contact pressure
- Highly reliable housing construction
- Mountable on a variety of panels
- Arm lock mechanism

## Specifications

- Current rating: 3A AC, DC max.
  - Voltage rating: 250V AC, DC max.
  - Temperature range: -25°C to +85°C  
(including temperature rise in applying electrical current)
  - Contact resistance: Initial value/ 10m Ω max.  
After environmental testing/ 20m Ω max.
  - Insulation resistance: 500M Ω min.
  - Withstanding voltage: 1,500V AC/minute
  - Applicable wire: AWG #28 to #22  
0.08 to 0.33mm<sup>2</sup>
  - Applicable panel thickness: 0.5 to 2.0mm
- \* Compliant with RoHS.  
\* Refer to "General Instruction and Notice when using Terminals and Connectors" at the end of this catalog.  
\* Contact JST for details.

## Standards

Recognized E60389

Certified LR20812

R50120150

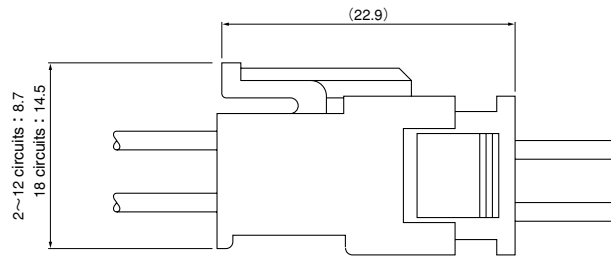

(2 to 12 circuits)

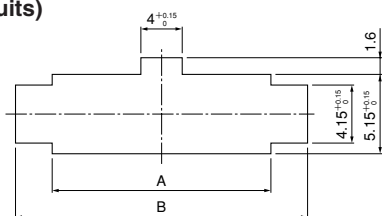

(18 circuits)

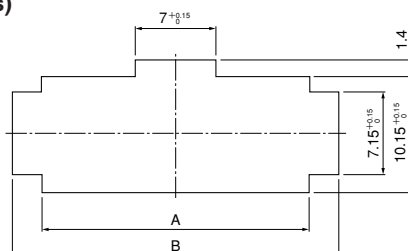

Circuits	Plug housing Model No.	Panel thickness (mm)					
		0.5~0.9		1.0~1.5		1.5~2.0	
		Panel hole dimensions (mm) General tolerance					
		A <sup>+0.15/0</sup>	B <sup>±0.1</sup>	A <sup>+0.15/0</sup>	B <sup>±0.1</sup>	A <sup>+0.15/0</sup>	B <sup>±0.1</sup>
2	SMP-02V-B(N)C	5.7	9.6	5.7	9.8	5.7	10.0
3	SMP-03V-B(N)C	8.2	12.1	8.2	12.3	8.2	12.5
4	SMP-04V-B(N)C	10.7	14.6	10.7	14.8	10.7	15.0
5	SMP-05V-B(N)C	13.2	17.1	13.2	17.3	13.2	17.5
6	SMP-06V-B(N)C	15.7	19.6	15.7	19.8	15.7	20.0
7	SMP-07V-B(N)C	18.2	22.1	18.2	22.3	18.2	22.5
8	SMP-08V-B(N)C	20.7	24.6	20.7	24.8	20.7	25.0
9	SMP-09V-B(N)C	23.2	27.1	23.2	27.3	23.2	27.5
10	SMP-10V-B(N)C	25.7	29.6	25.7	29.8	25.7	30.0
11	SMP-11V-B(N)C	28.2	32.1	28.2	32.3	28.2	32.5
12	SMP-12V-B(N)C	30.7	34.6	30.7	34.8	30.7	35.0
18	SMP-18V-B(N)C	23.2	27.2	23.2	27.4	23.2	27.6

Note: 1. Punch holes in the panel according to the sketch and table shown above. Burrs must be removed.  
2. The strength of the panel must be considered when punching two or more holes.  
3. The connector must be inserted from the same side as the hole is punched.

# SM CONNECTOR

## Contact

### Pin contact

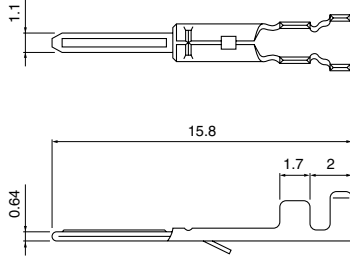

### Socket contact

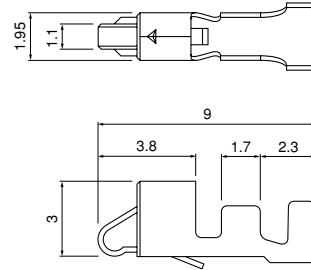

Model No.		Applicable wire		Insulation O.D. (mm)	Q'ty / reel
Pin contact	Socket contact	mm <sup>2</sup>	AWG #		
<b>SYM-001T-P0.6</b>	<b>SHF-001T-0.8BS</b>	0.08~0.33	28~22	1.2~1.8	Pin contact: 8,500 Socket contact: 5,000

### Material and Finish

Phosphor bronze, tin-plated (reflow treatment)

### RoHS compliance

Note: 1. Contact JST for special products.  
2. Contact JST for brass products.

Contact	Crimping machine	Applicator		
		Crimp applicator	Dies	Crimp applicator with dies
<b>SYM-001T-P0.6</b>	AP-K2N	MKS-L	MK/SYM-001-06	APLMK SYM001-06
		*MKS-SC	SC/SYM-001-06	APLSC SYM001-06

Contact	Crimping machine	Applicator		
		Crimp applicator	Dies	Crimp applicator with dies
<b>SHF-001T-0.8BS</b>	AP-K2N	MKS-L	MK/SHF-001-08S	APLMK SHF001-08S
		*MKS-SC	SC/SHF-001-08S	APLSC SHF001-08S

Note: \*Strip-crimp applicator

## Contact position location numbers

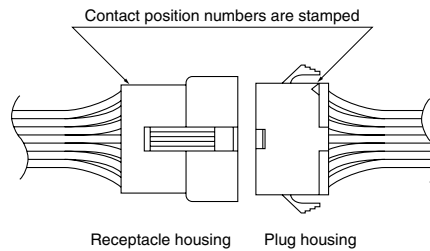

### Receptacle housing

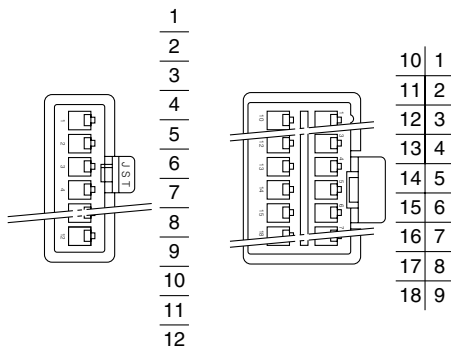

### Plug housing

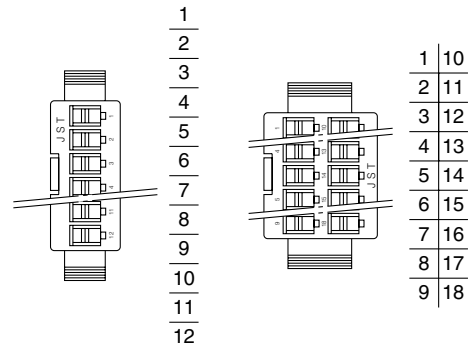

# SM CONNECTOR

## Housing

Material: PA 6, UL94V-0

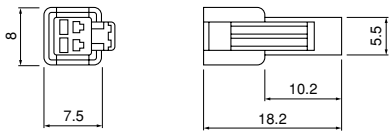
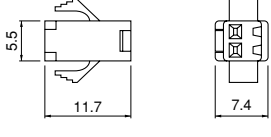
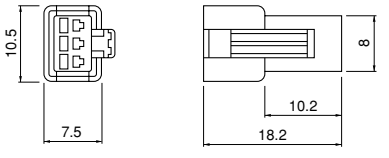
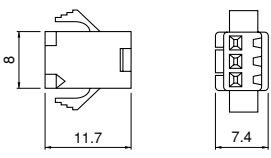
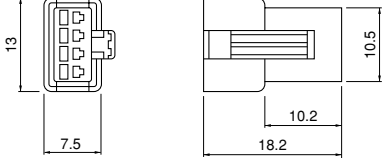
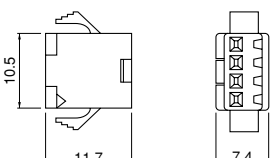
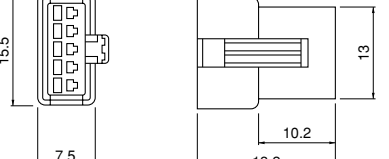
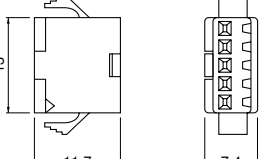
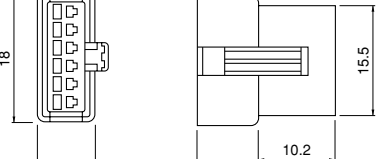
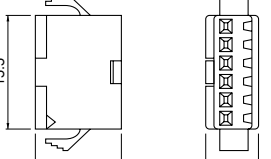
Circuits	Current rating	Receptacle housing(for pin contact)	Q'ty / bag	Plug housing(for socket contact)	Q'ty / bag
2	3A	<b>SMR-02V-B</b> , black <b>SMR-02V-N</b> , white (natural) 	1,000	<b>SMP-02V-BC</b> , black <b>SMP-02V-NC</b> , white (natural) 	1,000
3	3A	<b>SMR-03V-B</b> , black <b>SMR-03V-N</b> , white (natural) 	1,000	<b>SMP-03V-BC</b> , black <b>SMP-03V-NC</b> , white (natural) 	1,000
4	3A	<b>SMR-04V-B</b> , black <b>SMR-04V-N</b> , white (natural) 	500	<b>SMP-04V-BC</b> , black <b>SMP-04V-NC</b> , white (natural) 	1,000
5	3A	<b>SMR-05V-B</b> , black <b>SMR-05V-N</b> , white (natural) 	500	<b>SMP-05V-BC</b> , black <b>SMP-05V-NC</b> , white (natural) 	1,000
6	3A	<b>SMR-06V-B</b> , black <b>SMR-06V-N</b> , white (natural) 	500	<b>SMP-06V-BC</b> , black <b>SMP-06V-NC</b> , white (natural) 	500

RoHS compliance

# SM CONNECTOR

## Housing

Material: PA 6, UL94V-0

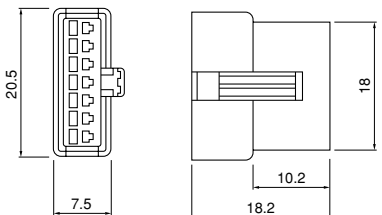
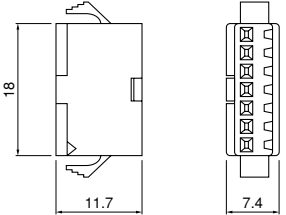
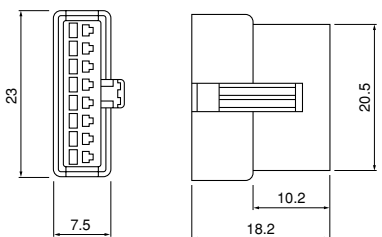
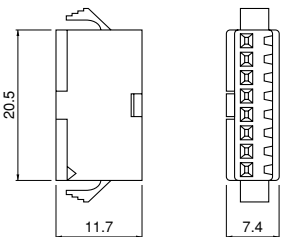
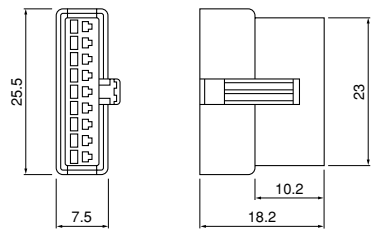
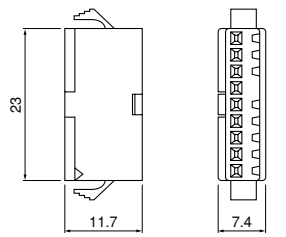
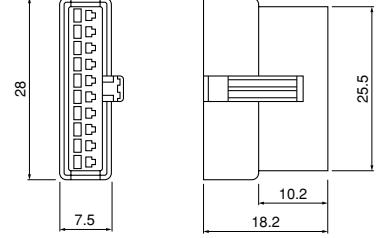
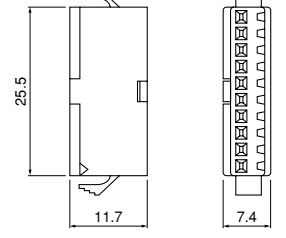
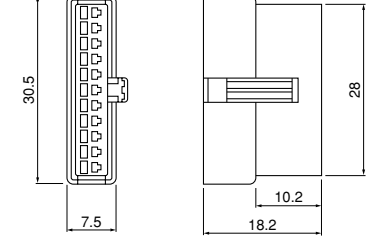
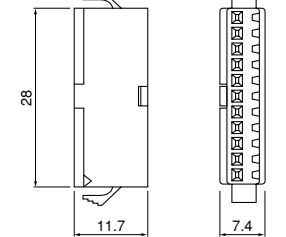
Circuits	Current rating	Receptacle housing(for pin contact)		Plug housing(for socket contact)	
7	3A	<b>SMR-07V-B</b> , black <b>SMR-07V-N</b> , white (natural) 	Q'ty / bag 500	<b>SMP-07V-BC</b> , black <b>SMP-07V-NC</b> , white (natural) 	Q'ty / bag 500
8	3A	<b>SMR-08V-B</b> , black <b>SMR-08V-N</b> , white (natural) 	Q'ty / bag 500	<b>SMP-08V-BC</b> , black <b>SMP-08V-NC</b> , white (natural) 	Q'ty / bag 500
9	3A	<b>SMR-09V-B</b> , black <b>SMR-09V-N</b> , white (natural) 	Q'ty / bag 500	<b>SMP-09V-BC</b> , black <b>SMP-09V-NC</b> , white (natural) 	Q'ty / bag 500
10	3A	<b>SMR-10V-B</b> , black <b>SMR-10V-N</b> , white (natural) 	Q'ty / bag 200	<b>SMP-10V-BC</b> , black <b>SMP-10V-NC</b> , white (natural) 	Q'ty / bag 500
11	3A	<b>SMR-11V-B</b> , black <b>SMR-11V-N</b> , white (natural) 	Q'ty / bag 200	<b>SMP-11V-BC</b> , black <b>SMP-11V-NC</b> , white (natural) 	Q'ty / bag 500

RoHS compliance

# SM CONNECTOR

## Housing

Material: PA 6, UL94V-0

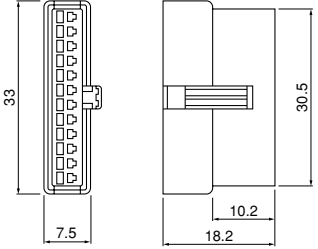
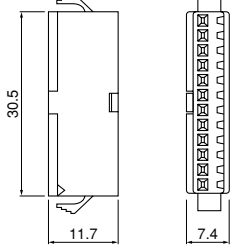
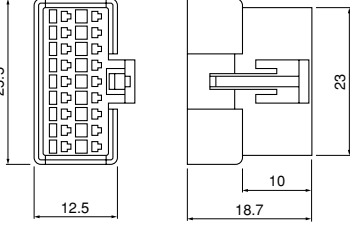
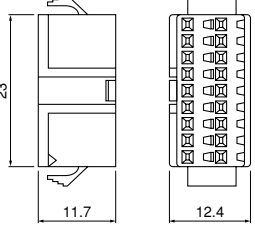
Circuits	Current rating	Receptacle housing(for pin contact)	Q'ty / bag	Plug housing(for socket contact)	Q'ty / bag
12	3A	<b>SMR-12V-B, black</b> <b>SMR-12V-N, white (natural)</b> 	500	<b>SMP-12V-BC, black</b> <b>SMP-12V-NC, white (natural)</b> 	500
18	2A	<b>SMR-18V-B, black</b> <b>SMR-18V-N, white (natural)</b> 	200	<b>SMP-18V-BC, black</b> <b>SMP-18V-NC, white (natural)</b> 	200

### RoHS compliance

Note: 1. SM connectors with any number of circuits can be used either panel mounted or free hanging.  
 2. Contact JST for special products.

## X-ON Electronics

Largest Supplier of Electrical and Electronic Components

*Click to view similar products for [Headers & Wire Housings](#) category:*

*Click to view products by [JST](#) manufacturer:*

Other Similar products are found below :

[95000-104TRLF](#) [10135584-644402LF](#) [DF62W-EP2022PCA](#) [95000-106TRLF](#) [DF62W-2022SCA](#) [DF62W-EP2022PC](#) [2203348](#) [DF62W-2022SC](#) [1084018](#) [1029039](#) [1084017](#) [802-10-012-10-002000](#) [1112640](#) [1112639](#) [891-007-9SS-BST1T](#) [000-34000](#) [0008550134](#) [0009482033](#) [0009507031](#) [57102-F02-18ULF](#) [57102-S06-03LF](#) [57202-S52-04LF](#) [PCN6-15S-2.5E](#) [0039019024](#) [58102-G61-06LF](#) [582553-1](#) [0009485154](#) [0009508121](#) [0022285053](#) [0050291907](#) [018731A](#) [LY20-4P-DT1-P1E-BR](#) [02.125.8002.8](#) [60101931](#) [60598-1 \(Cut Strip\)](#) [M1625-3R/100](#) [61062-3](#) [61082-181009](#) [CSU011177004](#) [636-1427](#) [638009-1](#) [641938-9](#) [641991-4](#) [644168-1](#) [644827-2](#) [647662-1](#) [65039-019ELF](#) [65692-001LF](#) [65781-018](#) [65781-047](#)