

Pushbuttons and Pilot Devices



Stacklights



Panel Meters



Operator Interfaces and Programming Software



4.1 Pushbutton and Pilot Devices	
Product Overview	V9-T4-2
M22—22.5 mm Modular Pushbutton.....	V9-T4-4
10250T—30 mm Pushbuttons	V9-T4-37
4.2 Stacklights	
Product Overview	V9-T4-49
E26 Stacklights	V9-T4-50
4.3 Panel Meters	
Product Overview	V9-T4-54
Digital Panel Meters	V9-T4-55
4.4 Operator Interfaces and Programming Software	
Product Overview	V9-T4-56
ELC-GP Graphics Panel	V9-T4-59
HMi Operator Interface	V9-T4-60
XV Operator Interface	V9-T4-62
XP Operator Interface	V9-T4-65

For our complete product offering, see Volume 7—Logic Control, Operator Interface and Connectivity Solutions, CA08100008E.

Product Overview

Pushbuttons and Pilot Devices Selection Guide



M22—22.5 mm Modular Pushbuttons



10250T—30 mm Pushbuttons

Description	M22—22.5 mm Modular Pushbuttons Page V9-T4-4	10250T—30 mm Pushbuttons Page V9-T4-37
Ease of Use		
Mounting nut on operator installation	Yes	Yes
Mounting adapter installation/removal	Easy	—
Contact block installation	Snaps on mounting adapter	Screw in
Contact block/light unit installation/removal	Easy	Easy
Visible actuator indication from rear	Yes	Yes
Optional spring cage terminations	Yes	—
Optional quick-connect terminations	Yes	Yes
Built-in or separate anti-rotation locking ring installation	Built-in	Built-in
Mounting time	Low	Low
Removal time	Low	Low
Flexibility and Modularity		
Field convertible pushbuttons—color or inscribed button caps	Yes	—
Field convertible pushbuttons—maintained to momentary	Yes	—
Field convertible selector switches—momentary to maintained	Yes	—
Field convertible key selector switches—key removal position	Yes	—
Universal voltage range LED light units ^①	Yes	—
Stackable contact blocks	Yes	—
Enclosed limit switch contacts ^②	Yes	—
Safety and Security		
ISO/EN 13850/EN 418 rated E-stops	Yes	Yes
Safety yellow E-stop enclosures	Yes	—
Secure anti-rotation mounting	Good	Good
Self-monitoring contact blocks	Yes, available 4Q 2010	No
Communications		
ASi bus network communications	Yes	—
DeviceNet network communications	—	—
PROFIBUS-DP network communications	—	—
Esthetics and Ergonomics		
Low profile design	Yes	—
Low power integrated LED illuminated devices	Yes	—
Permanent and wear-resistant markings	Yes	—
Square bezel pushbuttons and pilot lights	—	—

Notes

^① Eaton's M22 LED light units come in two convenient universal ranges: 12–30 Vac/Vdc and 85–244 Vac.

^② Eaton's M22 pushbutton, selector switch, and E-stop operators can be attached directly to Eaton's LS Series miniature limit switches.

For our complete product offering, see Volume 7—Logic Control, Operator Interface and Connectivity Solutions, CA08100008E.

Pushbuttons and Pilot Devices Selection Guide, continued



M22—22.5 mm Modular Pushbuttons



10250T—30 mm Pushbuttons

Description	M22—22.5 mm Modular Pushbuttons	10250T—30 mm Pushbuttons
Esthetics and Ergonomics		
Positive detent on selector switches	Very good	Fair
Ergonomic dome shaped E-stop and palm switches	Yes	—
Specialty Operator Types		
Acoustic indicators (buzzers)	Yes	—
Double pushbutton operators	Yes	No
Elevator E-stops (with mechanical flag indication)	Yes	—
EMO E-stops	—	No
Four-way pushbutton operators	Yes	—
Joysticks	Yes	—
Potentiometers	Yes	Yes
Reset pushbutton operators	Yes	Yes
Selector pushbutton (roto-push) operators	—	—
Selector switches with key monitoring	—	—
Toggle switches	—	—
Standards and Certifications		
China Compulsory Certification—CCC (China)	Yes	—
Conformité Européenne—CE (Europe)	Yes	Yes
Canadian Standard Association—CSA (Canada)	Yes	Yes
Gosudarstvennyy Standart Russia—GOST R (Russia)	Yes	—
Underwriter's Laboratories—UL (United States)	Yes	Yes
Marine Classification Societies		
American Bureau of Shipping—ABS (United States)	—	—
Bureau Veritas—BV (France)	Yes	—
Det Norske Veritas—DNV (Norway)	Yes	—
Germanischer Lloyd—GL (Germany)	Yes	—
Lloyd's Register—LR (United Kingdom)	Yes	—
Polski Regestre Statkow—PRS (Poland)	—	—
Registro Italiano Navale—RINA (Italy)	—	—
Russian Maritime Register of Shipping—RMRS (CIS)	—	—
Accessories		
USB socket bulkhead interface	Yes	—
RJ45 socket bulkhead interface	Yes	—
Padlock attachments for pushbuttons	—	Yes
Padlock attachments for selector switches	—	Yes
Padlock attachments for E-stops	No	—
Protective shrouds for E-stops	Yes	Yes
DIN rail mounting adapter	Yes	—

For our complete product offering, see Volume 7—Logic Control, Operator Interface and Connectivity Solutions, CA08100008E.

4.1

Operator Interface

Pushbutton and Pilot Devices

M22—22.5 mm Modular Pushbutton



4

Features

Highly modular and versatile line

- Field convertible functions (pushbuttons and selector switches), maintained to momentary
- Customizable laser engraving capabilities

LED indicators

- 100,000 hours of life in high-vibration environments
- Lenses specifically designed for LED illumination

Rugged design

- Most pushbutton operators and contact blocks exceed 5 million mechanical operations
- All components have IP66 rating, and some carry IP67 and IP69K for washdown environment; see Volume 7—Logic Control, Operator Interface and Connectivity Solutions, CA08100008E, Tab 1 for further technical data

Innovative technologies

- ASi communicating devices
- Palm switches

Standards and Certifications



Product Selection

Non-Illuminated Pushbuttons, Flush, Momentary

Complete Devices

	Bezel	Button Color	Contact Block Configuration ^①	Catalog Number
M22-D-G-K10 	Silver	Black	NO	M22-D-S-K10
			NC	M22-D-S-K01
			2NO	M22-D-S-K20
			2NC	M22-D-S-K02
			1NO-1NC	M22-D-S-K11
			Red	NO
	NC	M22-D-R-K01		
	2NO	M22-D-R-K20		
	2NC	M22-D-R-K02		
	1NO-1NC	M22-D-R-K11		
	Green	NO		M22-D-G-K10
		NC	M22-D-G-K01	
2NO		M22-D-G-K20		
2NC		M22-D-G-K02		
1NO-1NC		M22-D-G-K11		
M22S-D-G-K10 		Black	Black	NO
	NC			M22S-D-S-K01
	2NO			M22S-D-S-K20
	2NC			M22S-D-S-K02
	1NO-1NC			M22S-D-S-K11
	Red			NO
			NC	M22S-D-R-K01
			2NO	M22S-D-R-K20
			2NC	M22S-D-R-K02
			1NO-1NC	M22S-D-R-K11
			Green	NO
	NC			M22S-D-G-K01
	2NO			M22S-D-G-K20
	2NC			M22S-D-G-K02
	1NO-1NC			M22S-D-G-K11

Note

^① All NC contact blocks are positively driven contact. (⊖)

Non-Illuminated Pushbuttons, Flush

Components

M22-XD-G





Button Plates ①

Color	Inscription	Catalog Number
Black	—	M22-XD-S ②
	Custom	M22-XD-S-ETCH ③
	STOP	M22-XD-S-GB0
	START	M22-XD-S-GB1
	CLOSE	M22-XD-S-GB2
	UP	M22-XD-S-GB3
	DOWN	M22-XD-S-GB4
	OFF	M22-XD-S-GB5
	ON	M22-XD-S-GB6
	TEST	M22-XD-S-GB9
	FORWARD	M22-XD-S-GB15
	REVERSE	M22-XD-S-GB16
	RAISE	M22-XD-S-GB17
	LOWER	M22-XD-S-GB18
	⊙	M22-XD-S-X0
	①	M22-XD-S-X1
②	M22-XD-S-X2	
+	M22-XD-S-X4	
⊖	M22-XD-S-X5	
①	M22-XD-S-X7	
Red	—	M22-XD-R ②
	Custom	M22-XD-R-ETCH ③
	STOP	M22-XD-R-GB0
	OFF	M22-XD-R-GB5
	⊙	M22-XD-R-X0
Green	—	M22-XD-G ②
	Custom	M22-XD-G-ETCH ③
	START	M22-XD-G-GB1
	ON	M22-XD-G-GB6
	①	M22-XD-G-X1
Blue	—	M22-XD-B ②
	Custom	M22-XD-B-ETCH ③
	RESET	M22-XD-B-GB14
	Ⓜ	M22-XD-B-X6
White	—	M22-XD-W ②
	Custom	M22-XD-W-ETCH ③
	START	M22-XD-W-GB1
	①	M22-XD-W-X1
Yellow	—	M22-XD-Y ②
	Custom	M22-XD-Y-ETCH ③
Black, red, green	—	M22-XD-SRG
Black, white, red, green, yellow, blue	—	M22-XD-SWRGBYB

Momentary Buttonless Operator

	Bezel	Catalog Number ④
M22-D-X	Silver	M22-D-X
		
M22S-D-X	Black	M22S-D-X
		
M22-DG-X	Silver guarded	M22-DG-X
		

Maintained Buttonless Operator ⑤

	Bezel	Catalog Number ④
M22-DR-X	Silver	M22-DR-X
		
M22S-DR-X	Black	M22S-DR-X
		

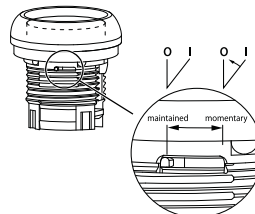

Notes

- ① For complete listing of available button plates and contact blocks, see Accessories, **Pages V9-T4-31 to V9-T4-36**.
- ② Minimum order quantity of (10).
- ③ When ordering, specify inscription per catalog number suffix from the Symbols Library (see Volume 7—Logic Control, Operator Interface and Connectivity Solutions, CA08100008E, Tab 1) into the Order Notes. For example, M22-XD-S-ETCH; Order Notes: Mark with symbol X91, Line item #_.
- ④ Includes contact block mounting adapter.
- ⑤ Maintained pushbuttons can be converted in the field to momentary operation by switching the locking ring, which is accessible through the side of the operator body.



Non-Illuminated Pushbuttons, Extended, Momentary

Complete Devices

	Bezel	Button Color	Contact Block Configuration ^①	Catalog Number
M22-DH-R-K10 	Silver	Red	NO	M22-DH-R-K10
			NC	M22-DH-R-K01
			2NO	M22-DH-R-K20
			2NC	M22-DH-R-K02
			1NO-1NC	M22-DH-R-K11
M22S-DH-R-K10 	Black	Red	NO	M22S-DH-R-K10
			NC	M22S-DH-R-K01
			2NO	M22S-DH-R-K20
			2NC	M22S-DH-R-K02
			1NO-1NC	M22S-DH-R-K11
M22-DGH-R-K10 	Silver guarded	Red	NO	M22-DGH-R-K10
			NC	M22-DGH-R-K01
			2NO	M22-DGH-R-K20
			2NC	M22-DGH-R-K02
			1NO-1NC	M22-DGH-R-K11

Note

^① All NC contact blocks are positively driven contact. ⊖

Non-Illuminated Pushbuttons, Extended

Components

M22-XDH-R



Button Plates ^①

Color	Inscription	Catalog Number
Black	—	M22-XDH-S ^②
	Custom	M22-XDH-S-ETCH ^③
	STOP	M22-XDH-S-GB0
	START	M22-XDH-S-GB1
	CLOSE	M22-XDH-S-GB2
	UP	M22-XDH-S-GB3
	DOWN	M22-XDH-S-GB4
	OFF	M22-XDH-S-GB5
	ON	M22-XDH-S-GB6
	TEST	M22-XDH-S-GB9
	FORWARD	M22-XDH-S-GB15
	REVERSE	M22-XDH-S-GB16
	RAISE	M22-XDH-S-GB17
	LOWER	M22-XDH-S-GB18
	⊙	M22-XDH-S-X0
	①	M22-XDH-S-X1
	②	M22-XDH-S-X2
+	M22-XDH-S-X4	
−	M22-XDH-S-X5	
①	M22-XDH-S-X7	
Red	—	M22-XDH-R ^②
	Custom	M22-XDH-R-ETCH ^③
	STOP	M22-XDH-R-GB0
	OFF	M22-XDH-R-GB5
	⊙	M22-XDH-R-X0
Green	—	M22-XDH-G ^②
	Custom	M22-XDH-G-ETCH ^③
	START	M22-XDH-G-GB1
	ON	M22-XDH-G-GB6
①	M22-XDH-G-X1	
Blue	—	M22-XDH-B ^②
	Custom	M22-XDH-B-ETCH ^③
	RESET	M22-XDH-B-GB14
Ⓡ	M22-XDH-B-X6	
White	—	M22-XDH-W ^②
	Custom	M22-XDH-W-ETCH ^③
	START	M22-XDH-W-GB1
①	M22-XDH-W-X1	
Yellow	—	M22-XDH-Y ^②
	Custom	M22-XDH-Y-ETCH ^③
Black, red, green	—	M22-XDH-SRG
Black, white, red, green, yellow, blue	—	M22-XDH-SWRGYB

Momentary Buttonless Operator

Bezel Catalog Number ^④

M22-D-X



Silver

M22-D-X

M22S-D-X



Black

M22S-D-X

M22-DG-X



Silver guarded

M22-DG-X

Maintained Buttonless Operator ^⑤

Bezel Catalog Number ^④

M22-DR-X



Silver

M22-DR-X

M22S-DR-X



Black

M22S-DR-X

Notes

- ① For complete listing of available button plates and contact blocks, see Accessories, Pages V9-T4-31 to V9-T4-36.
- ② Minimum order quantity of (10).
- ③ When ordering, specify inscription per catalog number suffix from the Symbols Library (see Volume 7—Logic Control, Operator Interface and Connectivity Solutions, CA08100008E, Tab 1) into the Order Notes. For example, M22-XDH-S-ETCH; Order Notes: Mark with symbol X91, Line item #_.
- ④ Includes contact block mounting adapter.
- ⑤ Maintained pushbuttons can be converted in the field to momentary operation by switching the locking ring, which is accessible through the side of the operator body.

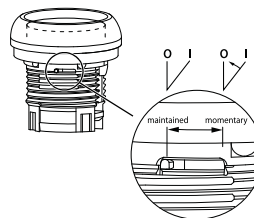

Illuminated Pushbuttons, Flush, Momentary

Complete Devices

	Bezel	Button Color	Contact Block Configuration ^①	Light Unit Voltage	Catalog Number
	Silver	Red	NC	12–30 Vac/Vdc	M22-DL-R-K01-R
			NC	85–264 Vac	M22-DL-R-K01-230R
			2NC	12–30 Vac/Vdc	M22-DL-R-K02-R
			2NC	85–264 Vac	M22-DL-R-K02-230R
			1NO/1NC	12–30 Vac/Vdc	M22-DL-R-K11-R
			1NO/1NC	85–264 Vac	M22-DL-R-K11-230R
	Green	Green	NO	12–30 Vac/Vdc	M22-DL-G-K10-G
			NO	85–264 Vac	M22-DL-G-K10-230G
			2NO	12–30 Vac/Vdc	M22-DL-G-K20-G
			2NO	85–264 Vac	M22-DL-G-K20-230G
			1NO/1NC	12–30 Vac/Vdc	M22-DL-G-K11-G
			1NO/1NC	85–264 Vac	M22-DL-G-K11-230G
	White	White	NO	12–30 Vac/Vdc	M22-DL-W-K10-W
			NO	85–264 Vac	M22-DL-W-K10-230W
			2NO	12–30 Vac/Vdc	M22-DL-W-K20-W
			2NO	85–264 Vac	M22-DL-W-K20-230W
			1NO/1NC	12–30 Vac/Vdc	M22-DL-W-K11-W
			1NO/1NC	85–264 Vac	M22-DL-W-K11-230W
	Black	Red	NC	12–30 Vac/Vdc	M22S-DL-R-K01-R
			NC	85–264 Vac	M22S-DL-R-K01-230R
			2NC	12–30 Vac/Vdc	M22S-DL-R-K02-R
			2NC	85–264 Vac	M22S-DL-R-K02-230R
			1NO/1NC	12–30 Vac/Vdc	M22S-DL-R-K11-R
			1NO/1NC	85–264 Vac	M22S-DL-R-K11-230R
	Green	Green	NO	12–30 Vac/Vdc	M22S-DL-G-K10-G
			NO	85–264 Vac	M22S-DL-G-K10-230G
			2NO	12–30 Vac/Vdc	M22S-DL-G-K20-G
			2NO	85–264 Vac	M22S-DL-G-K20-230G
			1NO/1NC	12–30 Vac/Vdc	M22S-DL-G-K11-G
			1NO/1NC	85–264 Vac	M22S-DL-G-K11-230G
	White	White	NO	12–30 Vac/Vdc	M22S-DL-W-K10-W
			NO	85–264 Vac	M22S-DL-W-K10-230W
			2NO	12–30 Vac/Vdc	M22S-DL-W-K20-W
			2NO	85–264 Vac	M22S-DL-W-K20-230W
			1NO/1NC	12–30 Vac/Vdc	M22S-DL-W-K11-W
			1NO/1NC	85–264 Vac	M22S-DL-W-K11-230W

Note

^① All NC contact blocks are positively driven contact. ⊖

Illuminated Pushbuttons, Flush

Components

M22-XDL-G



Button Lenses ^①

Color	Inscription	Catalog Number
Red	—	M22-XDL-R ^②
	Custom	M22-XDL-R-ETCH ^③
	STOP	M22-XDL-R-GB0
	OFF	M22-XDL-R-GB5
	Ⓞ	M22-XDL-R-X0
Green	—	M22-XDL-G ^②
	Custom	M22-XDL-G-ETCH ^③
	START	M22-XDL-G-GB1
	ON	M22-XDL-G-GB6
	Ⓛ	M22-XDL-G-X1
Blue	—	M22-XDL-B ^②
	Custom	M22-XDL-B-ETCH ^③
	RESET	M22-XDL-B-GB14
	Ⓜ	M22-XDL-B-X6
White	—	M22-XDL-W ^②
	Custom	M22-XDL-W-ETCH ^③
Yellow	—	M22-XDL-Y ^②
	Custom	M22-XDL-Y-ETCH ^③

Momentary Buttonless Operator

Bezel Catalog Number ^④

M22-DL-X



Silver

M22-DL-X

M22S-DL-X



Black

M22S-DL-X

M22-DGL-X



Silver guarded

M22-DGL-X

Maintained Buttonless Operator ^⑤

Bezel Catalog Number ^④

M22-DRL-X



Silver

M22-DRL-X

M22S-DRL-X



Black

M22S-DRL-X

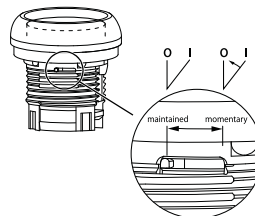

Notes

- ① For complete listing of available button plates and contact blocks, see Accessories, **Pages V9-T4-31 to V9-T4-36**.
- ② Minimum order quantity of (10).
- ③ When ordering, specify inscription per catalog number suffix from the Symbols Library (see Volume 7—Logic Control, Operator Interface and Connectivity Solutions, CA08100008E, Tab 1) into the Order Notes. For example, M22-XDL-R-ETCH; Order Notes: Mark with symbol X91, Line item #_.
- ④ Includes contact block mounting adapter.
- ⑤ Maintained pushbuttons can be converted in the field to momentary operation by switching the locking ring, which is accessible through the side of the operator body.



Illuminated Pushbuttons, Extended, Momentary

Complete Devices

	Bezel	Button Color	Contact Block Configuration ^①	Light Unit Voltage	Catalog Number
M22-DLH-R-K11-R 	Silver	Red	1NO/1NC	12–30 Vac/Vdc	M22-DLH-R-K11-R
			1NO/1NC	85–264 Vac	M22-DLH-R-K11-230R
	Black	Green	2NO	12–30 Vac/Vdc	M22-DLH-G-K20-G
			2NO	85–264 Vac	M22-DLH-G-K20-230G
		White	2NO	12–30 Vac/Vdc	M22-DLH-W-K20-W
			2NO	85–264 Vac	M22-DLH-W-K20-230W
M22S-DLH-R-K11-R 	Black	Red	1NO/1NC	12–30 Vac/Vdc	M22S-DLH-R-K11-R
			1NO/1NC	85–264 Vac	M22S-DLH-R-K11-230R
	Black	Green	2NO	12–30 Vac/Vdc	M22S-DLH-G-K20-G
			2NO	85–264 Vac	M22S-DLH-G-K20-230G
		White	2NO	12–30 Vac/Vdc	M22S-DLH-W-K20-W
			2NO	85–264 Vac	M22S-DLH-W-K20-230W

Note

^① All NC contact blocks are positively driven contact. ⊖

Illuminated Pushbuttons, Extended

Components

M22-XDH-R





Button Lenses ①

Color	Inscription	Catalog Number
Red	—	M22-XDLH-R ②
	Custom	M22-XDLH-R-ETCH ③
	STOP	M22-XDLH-R-GB0
	OFF	M22-XDLH-R-GB5
	Ⓞ	M22-XDLH-R-X0
Green	—	M22-XDLH-G ②
	Custom	M22-XDLH-G-ETCH ③
	START	M22-XDLH-G-GB1
	ON	M22-XDLH-G-GB6
	Ⓛ	M22-XDLH-G-X1
Blue	—	M22-XDLH-B ②
	Custom	M22-XDLH-B-ETCH ③
	RESET	M22-XDLH-B-GB14
	Ⓜ	M22-XDLH-B-X6
White	—	M22-XDLH-W ②
	Custom	M22-XDLH-W-ETCH ③
Yellow	—	M22-XDLH-Y ②
	Custom	M22-XDLH-Y-ETCH ③

Momentary Buttonless Operator

	Bezel	Catalog Number ④
M22-DL-X	Silver	M22-DL-X
		
M22S-DL-X	Black	M22S-DL-X
		
M22-DGL-X	Silver guarded	M22-DGL-X
		

Maintained Buttonless Operator ⑤

	Bezel	Catalog Number ④
M22-DRL-X	Silver	M22-DRL-X
		
M22S-DRL-X	Black	M22S-DRL-X
		

Notes

- ① For complete listing of available button plates and contact blocks, see Accessories, **Pages V9-T4-31 to V9-T4-36**.
- ② Minimum order quantity of (10).
- ③ When ordering, specify inscription per catalog number suffix from the Symbols Library (see Volume 7—Logic Control, Operator Interface and Connectivity Solutions, CA08100008E, Tab 1) into the Order Notes. For example, M22-XDH-S-ETCH; Order Notes: Mark with symbol X91, Line item #_.
- ④ Includes contact block mounting adapter.
- ⑤ Maintained pushbuttons can be converted in the field to momentary operation by switching the locking ring, which is accessible through the side of the operator body.

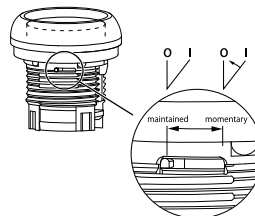

Indicating Lights, Flush

M22-L-R-R



Complete Devices

Lens Color	Light Color	Light Unit Voltage	Catalog Number
White	White	12–30 Vac/Vdc	M22-L-W-W
Red	Red		M22-L-R-R
Green	Green		M22-L-G-G
Yellow	White		M22-L-Y-W
Blue	Blue		M22-L-B-B
Amber	White		M22-L-A-W
White	White	85–264 Vac	M22-L-W-230W
Red	Red		M22-L-R-230R
Green	Green		M22-L-G-230G
Yellow	White		M22-L-Y-230W
Blue	Blue		M22-L-B-230B
Amber	White		M22-L-A-230W

M22S-DLH-R-K11-R



Complete Press-to-Test Units

Bezel	Button Color	Light Unit Voltage	Catalog Number
Silver	Red	12–30 Vac/Vdc	M22-T-R-R
	Blue		M22-T-B-B
	Yellow		M22-T-Y-W
	Green		M22-T-G-G
	White		M22-T-W-W
	Red	85–264 Vac	M22-T-R-230R
	Blue		M22-T-R-230B
	Yellow		M22-T-Y-230W
	Green		M22-T-G-230G
	White		M22-T-W-230W
Black	Red	12–30 Vac/Vdc	M22S-T-R-R
	Blue		M22S-T-B-B
	Yellow		M22S-T-Y-W
	Green		M22S-T-G-G
	White		M22S-T-W-W
	Red	85–264 Vac	M22S-T-R-230R
	Blue		M22S-T-B-230B
	Yellow		M22S-T-Y-230W
	Green		M22S-T-G-230G
	White		M22S-T-W-230W

Components

M22-XL-R

Lenses ^①

Color	Inscription	Catalog Number
Red	—	M22-XL-R ^②
	Custom	M22-XL-R-ETCH ^③
	OFF	M22-XL-R-GB5
Green	—	M22-XL-G ^②
	Custom	M22-XL-G-ETCH ^③
	ON	M22-XL-G-GB6
	REVERSE	M22-XL-G-GB16
Blue	—	M22-XL-B ^②
	Custom	M22-XL-B-ETCH ^③
	FAULT	M22-XL-B-GB8
White	—	M22-XL-W ^②
	Custom	M22-XL-W-ETCH ^③
	OFF	M22-XL-W-GB5
	ON	M22-XL-W-GB6
	FAULT	M22-XL-W-GB8
	FORWARD	M22-XL-W-GB15
Yellow	—	M22-XL-Y ^②
	Custom	M22-XL-Y-ETCH ^③
Amber	—	M22-XL-A ^②
	Custom	M22-XL-A-ETCH ^③

M22-L-X



Lensless Indicating Light

Catalog Number

M22-L-X

Notes

- ① For complete listing of available lenses and light units, see Accessories, **Pages V9-T4-31 to V9-T4-36**.
- ② Minimum order quantity of (10).
- ③ When ordering, specify inscription per catalog number suffix from the Symbols Library (see Volume 7—Logic Control, Operator Interface and Connectivity Solutions, CA08100008E, Tab 1) into the Order Notes. For example, M22-XL-R-ETCH; Order Notes: Mark with symbol X91, Line item #_.

Non-Illuminated Emergency Stops

M22-PV-K01

Complete Devices



Type	Color	Contact Block Configuration ^①	Catalog Number
Push-pull	Red	NC	M22-PV-K01
		2NC	M22-PV-K02
		1NO-2NC	M22-PV-K12
Twist-to-release	Red	NC	M22-PVT-K01
		2NC	M22-PVT-K02
		1NO-2NC	M22-PVT-K12
Key release	Red	NC	M22-PVS-K01
		2NC	M22-PVS-K02
		1NO-2NC	M22-PVS-K12

Components

Operators Only ^②

M22-PV



Type	Color	Catalog Number
Push-pull	Red	M22-PV
	Black	M22S-PV

M22S-PVT



Twist-to-release	Red	M22-PVT
	Black	M22S-PVT

Key release ^③	Red	M22-PVS ^④
		M22-PVS-MS2
		M22-PVS-MS3
		M22-PVS-MS4
		M22-PVS-MS5
		M22-PVS-MS6
		M22-PVS-MS7
		M22-PVS-MS8

Notes

- ① All NC contact blocks are positively driven contact. ↻
- ② Includes contact block mounting adapter.
- ③ Key included. For identical locks and keys, use the same key code. One key is included with actuator; additional keys are available as accessories.
- ④ Includes Key Code MS1.

Illuminated Emergency Stops

M22-PVL-K01-R

Complete Devices



Type	Button Color	LED Color	Contact Block Configuration ^①	Light Unit Voltage	Catalog Number
Push-pull	Red	Red	NC	12–30 Vac/Vdc	M22-PVL-K01-R
			2NC	12–30 Vac/Vdc	M22-PVL-K02-R
			1NO-2NC	12–30 Vac/Vdc	M22-PVL-K12-R
			NC	85–264 Vac	M22-PVL-K01-230R
			2NC	85–264 Vac	M22-PVL-K02-230R
			1NO-2NC	85–264 Vac	M22-PVL-K12-230R
Twist-to-release			NC	12–30 Vac/Vdc	M22-PVLT-K01-R
			2NC	12–30 Vac/Vdc	M22-PVLT-K02-R
			1NO-2NC	12–30 Vac/Vdc	M22-PVLT-K12-R
			NC	85–264 Vac	M22-PVLT-K01-230R
			2NC	85–264 Vac	M22-PVLT-K02-230R
			1NO-2NC	85–264 Vac	M22-PVLT-K12-230R

Components

Operators Only ^②

M22-PVL



Type	Color	Catalog Number
Push-pull	Red	M22-PVL
	Black	M22S-PVL

M22S-PVLT



Type	Color	Catalog Number
Twist-to-release	Red	M22-PVLT
	Black	M22S-PVLT



Notes

- ① All NC contact blocks are positively driven contact. ⊖
- ② Includes contact block mounting adapter.

Non-Illuminated Selector Switches

M22-WKV-K10

Complete Devices, Knob Type ^①

Type	Switching Position	Bezel	Contact Block Configuration ^②	Catalog Number
Two-position	Maintained 	Silver	NO	M22-WRK-K10
			1NO-1NC	M22-WRK-K11
			2NO-2NC	M22-WRK-K22
	Maintained V 	Silver	NO	M22-WKV-K10
			1NO-1NC	M22-WKV-K11
			2NO-2NC	M22-WKV-K22
Three-position	Maintained 	Silver	2NO	M22-WRK3-K20
			2NO-2NC	M22-WRK3-K22
			2NO	M22S-WRK3-K20
		Black	2NO	M22S-WRK3-K20
			2NO-2NC	M22S-WRK3-K22
			2NO-2NC	M22S-WRK3-K22

Notes^① Includes contact block mounting adapter.^② All NC contact blocks are positively driven contact. ⊖

Non-Illuminated Selector Switches, continued







Components

M22-WK



4

Operators Only, Knob Type ①

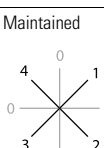
Type	Switching Position	Bezel	Catalog Number
Two-position	Momentary ② 	Silver	M22-WK
		Black	M22S-WK
	Maintained 	Silver	M22-WRK
		Black	M22S-WRK
	Maintained V 	Silver	M22-WKV
		Black	M22S-WKV
Three-position	Momentary ② 	Silver	M22-WK3
		Black	M22S-WK3
	Maintained 	Silver	M22-WRK3
		Black	M22S-WRK3
	Maintained, return from left 	Silver	M22-WRK3-2
		Black	M22S-WRK3-2
	Maintained, return from right 	Silver	M22-WRK3-1
		Black	M22S-WRK3-1
Four-position	Maintained 	Silver	M22-WRK4
		Black	M22S-WRK4

Notes

- ① Includes contact block mounting adapter.
- ② Momentary selector switches can be converted in the field to maintained operation with the removal of a color coded adapter. See Volume 7—Logic Control, Operator Interface and Connectivity Solutions, CA0810008E, Tab 1.

Non-Illuminated Selector Switches, continued

Components

M22S-WR3-X94



Operators Only, Rotary Type ^①

Type	Switching Position	Bezel	Inscription	Catalog Number
Two-position	Momentary ^②	Silver	I-O	M22-W
		Black	I-O	M22S-W
	Maintained	Silver	I-O	M22-WR
			Custom	M22-WR-ETCH ^③
			AUTO-HAND	M22-WR-X91
			II-I	M22-WR-X92
		Black	I-O	M22S-WR
			Custom	M22S-WR-ETCH ^③
			AUTO-HAND	M22S-WR-X91
			II-I	M22S-WR-X92
Three-position	Momentary ^②	Silver	I-O-II	M22-W3
		Black	I-O-II	M22S-W3
	Maintained	Silver	I-O-II	M22-WR3
			Custom	M22-WR3-ETCH ^③
			AUTO-O-MAN	M22-WR3-X94
		Black	I-O-II	M22S-WR3
			Custom	M22S-WR3-ETCH ^③
			AUTO-O-MAN	M22S-WR3-X94
Four-position	Maintained	Silver	0-1-0-2-0-3-0-4	M22-WR4
		Black	0-1-0-2-0-3-0-4	M22S-WR4

Notes

- ① Includes contact block mounting adapter.
- ② Momentary selector switches can be converted in the field to maintained operation with the removal of a color coded adapter. See Volume 7—Logic Control, Operator Interface and Connectivity Solutions, CA08100008E, Tab 1.
- ③ When ordering, specify inscription per catalog number suffix from the Symbols Library (see Volume 7—Logic Control, Operator Interface and Connectivity Solutions, CA08100008E, Tab 1) into the Order Notes. For example, M22-WR3-ETCH; Order Notes: Mark with symbol X88, Line item #_.

Illuminated Selector Switches

Components

M22-WLK-W



Operators Only, Knob Type ^①

Type	Switching Position	Bezel	Button Color	Catalog Number
Two-position	Momentary ^② 	Silver	White	M22-WLK-W
			Red	M22-WLK-R
			Green	M22-WLK-G
			Yellow	M22-WLK-Y
			Blue	M22-WLK-B
			Black	M22S-WLK-W
	Black	White	M22S-WLK-W	
		Red	M22S-WLK-R	
		Green	M22S-WLK-G	
		Yellow	M22S-WLK-Y	
		Blue	M22S-WLK-B	
		Black	M22S-WLK-B	
	Maintained 	Silver	White	M22-WRLK-W
			Red	M22-WRLK-R
			Green	M22-WRLK-G
			Yellow	M22-WRLK-Y
			Blue	M22-WRLK-B
			Black	M22S-WRLK-W
Black		White	M22S-WRLK-W	
		Red	M22S-WRLK-R	
		Green	M22S-WRLK-G	
		Yellow	M22S-WRLK-Y	
		Blue	M22S-WRLK-B	
		Black	M22S-WRLK-B	
Maintained V 	Silver	White	M22-WLKV-W	
		Red	M22-WLKV-R	
		Green	M22-WLKV-G	
		Yellow	M22-WLKV-Y	
		Blue	M22-WLKV-B	
		Black	M22S-WLKV-W	
	Black	White	M22S-WLKV-W	
		Red	M22S-WLKV-R	
		Green	M22S-WLKV-G	
		Yellow	M22S-WLKV-Y	
		Blue	M22S-WLKV-B	
		Black	M22S-WLKV-B	

Notes

- ① Includes contact block mounting adapter.
- ② Momentary selector switches can be converted in the field to maintained operation with the removal of a color coded adapter. See Volume 7—Logic Control, Operator Interface and Connectivity Solutions, CA08100008E, Tab 1.





Illuminated Selector Switches, continued

Components

M22-WLK3-W



Operators Only, Knob Type ①

Type	Switching Position	Bezel	Button Color	Catalog Number
Three-position	Momentary ② 	Silver	White	M22-WLK3-W
			Red	M22-WLK3-R
			Green	M22-WLK3-G
			Yellow	M22-WLK3-Y
			Blue	M22-WLK3-B
		Black	White	M22S-WLK3-W
			Red	M22S-WLK3-R
			Green	M22S-WLK3-G
			Yellow	M22S-WLK3-Y
			Blue	M22S-WLK3-B
Maintained		Silver	White	M22-WRLK3-W
			Red	M22-WRLK3-R
			Green	M22-WRLK3-G
			Yellow	M22-WRLK3-Y
			Blue	M22-WRLK3-B
		Black	White	M22S-WRLK3-W
			Red	M22S-WRLK3-R
			Green	M22S-WRLK3-G
			Yellow	M22S-WRLK3-Y
			Blue	M22S-WRLK3-B
Maintained, return from right		Silver	White	M22-WRLK3-1-W
			Red	M22-WRLK3-1-R
			Green	M22-WRLK3-1-G
			Yellow	M22-WRLK3-1-Y
			Blue	M22-WRLK3-1-B
		Black	White	M22S-WRLK3-1-W
			Red	M22S-WRLK3-1-R
			Green	M22S-WRLK3-1-G
			Yellow	M22S-WRLK3-1-Y
			Blue	M22S-WRLK3-1-B
Maintained, return from left		Silver	White	M22-WRLK3-2-W
			Red	M22-WRLK3-2-R
			Green	M22-WRLK3-2-G
			Yellow	M22-WRLK3-2-Y
			Blue	M22-WRLK3-2-B
		Black	White	M22S-WRLK3-2-W
			Red	M22S-WRLK3-2-R
			Green	M22S-WRLK3-2-G
			Yellow	M22S-WRLK3-2-Y
			Blue	M22S-WRLK3-2-B

Notes

① Includes contact block mounting adapter.

② Momentary selector switches can be converted in the field to maintained operation with the removal of a color coded adapter. See Volume 7—Logic Control, Operator Interface and Connectivity Solutions, CA08100008E, Tab 1.

4.1

Operator Interface







Pushbutton and Pilot Devices

Key-Operated Selector Switches ^{①②}

For additional key code options, see Volume 7—Solid-State Motor Control, CA08100008E, Tab 1.

Components

Operators Only ^③



Type	Switching Position	Key Code	Bezel	Key Removal Position	Catalog Number
M22-WS 	Two-position Momentary ^④ 	MS1	Silver	Return from right, key removable left	M22-WS
			Black	Return from right, key removable left	M22S-WS
M22S-WRS 	Two-position Maintained 	MS1	Silver	Key removable left	M22-WRS-A1
				Key removable left/right	M22-WRS
		MS1	Black	Key removable left	M22S-WRS-A1
				Key removable left/right	M22S-WRS
M22-WS3-X93 	Three-position Momentary ^④ 	MS1	Silver	Return from left/right, key removable center	M22-WS3
			Black	Return from left/right, key removable center	M22S-WS3
	Maintained 	MS1	Silver	Key removable center	M22-WRS3-A1
				Key removable center/left	M22-WRS3-A2
				Key removable center/right	M22-WRS3-A3
				Key removable left/right	M22-WRS3
				Return from left, key removable center	M22-WRS3-A7
				Return from left, key removable center/right	M22-WRS3-A6
				Return from right, key removable left/center	M22-WRS3-A4
				Return from right, key removable center	M22-WRS3-A5
	Black	MS1	Key removable center	M22S-WRS3-A1	
			Key removable center/left	M22S-WRS3-A2	
			Key removable center/right	M22S-WRS3-A3	
			Key removable left/right/center	M22S-WRS3	
			Return from left, key removable center	M22S-WRS3-A7	
			Return from left, key removable center/right	M22S-WRS3-A6	
Return from right, key removable left/center			M22S-WRS3-A4		
Return from right, key removable center			M22S-WRS3-A5		

Notes

- ① Includes one key.
- ② Key removal positions can be modified in the field using coding adapters; see Volume 7—Logic Control, Operator Interface and Connectivity Solutions, CA08100008E, Tab 1.
- ③ Includes contact block mounting adapter.
- ④ Momentary selector switches can be converted in the field to maintained operation with the removal of a color coded adapter. See Volume 7—Logic Control, Operator Interface and Connectivity Solutions CA08100008E, Tab 1.



Mushroom Head Pushbuttons ①

Momentary Complete Devices

	Bezel	Button Color	Contact Block Configuration ②	Catalog Number
 <p>M22-DP-R-K01</p>	Silver	Red	NC	M22-DP-R-K01
			2NC	M22-DP-R-K02
			1NO-2NC	M22-DP-R-K12
			1NO-1NC	M22-DP-R-K11
 <p>M22S-DP-R-K01</p>	Black	Red	NC	M22S-DP-R-K01
			2NC	M22S-DP-R-K02
			1NO-2NC	M22S-DP-R-K12
			1NO-1NC	M22S-DP-R-K11

Non-Illuminated Mushroom Head Pushbuttons, Maintained ① ③

Complete Devices

	Bezel	Button Color	Contact Block Configuration ④	Catalog Number
 <p>M22-DRP-R-K01</p>	Silver	Red	NC	M22-DRP-R-K01
			2NC	M22-DRP-R-K02
			1NO-2NC	M22-DRP-R-K12
			1NO-1NC	M22-DRP-R-K11
 <p>M22S-DRP-R-K01</p>	Black	Red	NC	M22S-DRP-R-K01
			2NC	M22S-DRP-R-K02
			1NO-2NC	M22S-DRP-R-K12
			1NO-1NC	M22S-DRP-R-K11

Notes

- ① 35 mm diameter mushroom head button.
- ② Includes contact block mounting adapter. Ⓣ
- ③ Maintained pushbuttons can be converted in the field to momentary operation by switching the locking ring, which is accessible through the side of the operator body.
- ④ All NC contact blocks are positively driven contact. Ⓣ

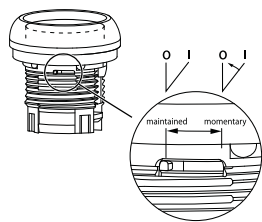

Non-Illuminated Mushroom Head Pushbuttons ①

Components

M22-XDP-G



Mushroom Head Plates

Color	Inscription	Catalog Number
Black	—	M22-XDP-S ②
	Custom	M22-XDP-S-ETCH ③
	STOP	M22-XDP-S-GB0
	START	M22-XDP-S-GB1
	FORWARD	M22-XDP-S-GB15
	REVERSE	M22-XDP-S-GB16
	UP	M22-XDP-S-GB3
	DOWN	M22-XDP-S-GB4
	OFF	M22-XDP-S-GB5
	ON	M22-XDP-S-GB6
	⊙	M22-XDP-S-X0
	⓪	M22-XDP-S-X1
	⊕	M22-XDP-S-X4
⊖	M22-XDP-S-X5	
⓪	M22-XDP-S-X7	
Red	—	M22-XDP-R ②
	Custom	M22-XDP-R-ETCH ③
	STOP	M22-XDP-R-GB0
	OFF	M22-XDP-R-GB5
	⊙	M22-XDP-R-X0
Green	—	M22-XDP-G ②
	Custom	M22-XDP-G-ETCH ③
	START	M22-XDP-G-GB1
	ON	M22-XDP-G-GB6
	⊙	M22-XDP-G-X0
White	—	M22-XDP-W ②
	Custom	M22-XDP-W-ETCH ③
Yellow	—	M22-XDP-Y ②
	Custom	M22-XDP-Y-ETCH ③

M22-DP-G-X



Momentary Insertless Mushroom Head Operators

Bezel	Color	Catalog Number
Silver	Black	M22-DP-S-X
	Red	M22-DP-R-X
	Green	M22-DP-G-X
	Yellow	M22-DP-Y-X
Black	Black	M22S-DP-S-X
	Red	M22S-DP-R-X
	Green	M22S-DP-G-X
	Yellow	M22S-DP-Y-X

M22-DRP-G-X



Maintained Insertless Mushroom Head Operators ④

Bezel	Color	Catalog Number
Silver	Black	M22-DRP-S-X
	Red	M22-DRP-R-X
	Green	M22-DRP-G-X
	Yellow	M22-DRP-Y-X
Black	Black	M22S-DRP-S-X
	Red	M22S-DRP-R-X
	Green	M22S-DRP-G-X
	Yellow	M22S-DRP-Y-X

Notes

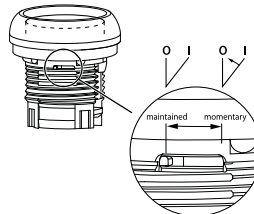

- ① 35 mm diameter mushroom head button.
- ② Minimum order quantity of (10).
- ③ When ordering, specify inscription per catalog number suffix from the Symbols Library (see Volume 7—Logic Control, Operator Interface and Connectivity Solutions, CA08100008E, Tab 1) into the Order Notes.
For example, M22-XDP-S-ETCH; Order Notes: Mark with symbol X91, Line item #_.
- ④ Maintained pushbuttons can be converted in the field to momentary operation by switching the locking ring, which is accessible through the side of the operator body.



Components

Double Pushbuttons, Extended Pushbuttons and Center Light, Momentary

Operators Only ^①

	Bezel	Color		Inscription		Catalog Number
		Top	Bottom	Top	Bottom	
 <p>M22-DDL-GR-GB1-GB0</p>	Silver	Green	Red	—	—	M22-DDL-GR
				Custom	Custom	M22-DDL-GR-ETCH ^②
				①	Ⓢ	M22-DDL-GR-X1-X0
				START	STOP	M22-DDL-GR-GB1-GB0
		White	Black	—	—	M22-DDL-WS
				Custom	Custom	M22-DDL-WS-ETCH ^②
				①	Ⓢ	M22-DDL-WS-X1-X0
				START	STOP	M22-DDL-WS-GB1-GB0
		Black	Black	—	—	M22-DDL-S
				Custom	Custom	M22-DDL-S-ETCH ^②
				—	—	M22-DDL-S-X4-X5
				①	①	M22-DDL-S-X7-X7
 <p>M22S-DDL-GR-X1-X0</p>	Black	Green	Red	—	—	M22S-DDL-GR
				Custom	Custom	M22S-DDL-GR-ETCH ^②
				①	Ⓢ	M22S-DDL-GR-X1-X0
				START	STOP	M22S-DDL-GR-GB1-GB0
		White	Black	—	—	M22S-DDL-WS
				Custom	Custom	M22S-DDL-WS-ETCH ^②
				①	Ⓢ	M22S-DDL-WS-X1-X0
				START	STOP	M22S-DDL-WS-GB1-GB0
		Black	Black	—	—	M22S-DDL-S
				Custom	Custom	M22S-DDL-S-ETCH ^②
				+	—	M22S-DDL-S-X4-X5
				①	①	M22S-DDL-S-X7-X7

Notes

- ① Includes contact block mounting adapter.
- ② When ordering, specify inscription per catalog number suffix from the Symbols Library (see Volume 7—Logic Control, Operator Interface and Connectivity Solutions, CA08100008E, Tab 1) into the Order Notes. For example, M22-DDL-S-ETCH; Order Notes: Mark with symbol X91, Line item #_.



4.1

Operator Interface

Pushbutton and Pilot Devices



Double Pushbuttons, Flush Top Pushbuttons and Center Light, Momentary

Operators Only ^①

	Bezel	Color Top	Bottom	Inscription Top	Bottom	Catalog Number
M22-DDLF-GR 	Silver	Green	Red	—	—	M22-DDLF-GR
		White	Black	—	—	M22-DDLF-GR-ETCH ^②
		Green	Red	⓪	⓪	M22-DDLF-GR-X1-X0
		White	Black	⓪	⓪	M22-DDLF-GR-X1-X0
		Green	Red	⓪	⓪	M22-DDLF-GR-X1-X0
M22S-DDLF-GR-X1-X0 	Black	Green	Red	—	—	M22S-DDLF-GR
		White	Black	—	—	M22S-DDLF-GR-ETCH ^②
		Green	Red	⓪	⓪	M22S-DDLF-GR-X1-X0
		White	Black	⓪	⓪	M22S-DDLF-GR-X1-X0
		Green	Red	⓪	⓪	M22S-DDLF-GR-X1-X0

Double Pushbuttons, Flush Top Pushbutton and Center Light, Extended Bottom Pushbutton, Momentary

Operators Only ^①

	Bezel	Color Top	Bottom	Inscription Top	Bottom	Catalog Number
M22-DDLM-GR 	Silver	Green	Red	—	—	M22-DDLM-GR
		White	Black	—	—	M22-DDLM-GR-ETCH ^②
		Green	Red	⓪	⓪	M22-DDLM-GR-X1-X0
		White	Black	⓪	⓪	M22-DDLM-GR-X1-X0
		Green	Red	⓪	⓪	M22-DDLM-GR-X1-X0
M22S-DDLM-GR-X1-X0 	Black	Green	Red	—	—	M22S-DDLM-GR
		White	Black	—	—	M22S-DDLM-GR-ETCH ^②
		Green	Red	⓪	⓪	M22S-DDLM-GR-X1-X0
		White	Black	⓪	⓪	M22S-DDLM-GR-X1-X0
		Green	Red	⓪	⓪	M22S-DDLM-GR-X1-X0

Notes

^① Includes contact block mounting adapter.

^② When ordering, specify inscription per catalog number suffix from the Symbols Library (see Volume 7—Logic Control, Operator Interface and Connectivity Solutions, CA08100008E, Tab 1) into the Order Notes. For example, M22-DDLM-GR-ETCH; Order Notes: Mark with symbol X91, Line item #_.

Four-Way Pushbuttons, Momentary

Components

M22-D4-S-X7



Operators Only ^①

Type	Bezel	Color	Inscription	Catalog Number
Non-interlocked	Silver	Black	—	M22-D4-S
			Custom	M22-D4-S-ETCH ^②
			Directional arrows	M22-D4-S-X7
	Black	Black	—	M22S-D4-S
			Custom	M22S-D4-S-ETCH ^②
			Directional arrows	M22S-D4-S-X7
Interlocked	Silver	Black	—	M22-DI4-S
			Custom	M22-DI4-S-ETCH ^②
			Directional arrows	M22-DI4-S-X7
	Black	Black	—	M22S-DI4-S
			Custom	M22S-DI4-S-ETCH ^②
			Directional arrows	M22S-DI4-S-X7

Joysticks

Components

M22-WJ2H



Operators Only ^①

Bezel	Number of Directions	Switching Position	Catalog Number	
Silver	Two-position horizontal	Momentary	M22-WJ2H	
		Two switch points	M22-WJ2H-2P	
	Two-position horizontal	Maintained	M22-WRJ2H	
		Two-position vertical	Momentary	M22-WJ2V
	Two switch points		M22-WJ2V-2P	
	Two-position vertical	Maintained	M22-WRJ2V	
		Four-position	Momentary	M22-WJ4
	Two switch points		M22-WJ4-2P	
	Four-position	Maintained	M22-WRJ4	
		Black	Two-position horizontal	Momentary
	Two switch points			M22S-WJ2H-2P
	Two-position horizontal		Maintained	M22S-WRJ2H
Two-position vertical			Momentary	M22S-WJ2V
	Two switch points		M22S-WJ2V-2P	
Two-position vertical	Maintained		M22S-WRJ2V	
	Four-position		Momentary	M22S-WJ4
Two switch points			M22S-WJ4-2P	
Four-position	Maintained		M22S-WRJ4	

Notes

- ^① Includes contact block mounting adapter.
- ^② When ordering, specify inscription per catalog number suffix from the Symbols Library (see Volume 7—Logic Control, Operator Interface and Connectivity Solutions, CA08100008E, Tab 1) into the Order Notes. For example, M22-DDLM-GR-ETCH; Order Notes: Mark with symbol X91, Line item #_

Potentiometers

M22-R10K



Complete Devices

Bezel	Resistance Rk	Catalog Number
Silver	1	M22-R1K
	4.7	M22-R4K7
	10	M22-R10K
	47	M22-R47K
	100	M22-R100K
	470	M22-R470K
Black	1	M22S-R1K
	4.7	M22S-R4K7
	10	M22S-R10K
	47	M22S-R47K
	100	M22S-R100K
	470	M22S-R470K
Oversized Knob		
Silver	1	M22-R1K-RH
	4.7	M22-R4K7-RH
	10	M22-R10K-RH
	47	M22-R47K-RH
	100	M22-R100K-RH
	470	M22-R470K-RH
Black	1	M22S-R1K-RH
	4.7	M22S-R4K7-RH
	10	M22S-R10K-RH
	47	M22S-R47K-RH
	100	M22S-R100K-RH
	470	M22S-R470K-RH

Acoustic Devices

M22-AMC-XAM



Complete Devices

Description	Decibel Rating	Catalog Number
Indicator with buzzer, black continuous tone, 18–30 Vac/Vdc	83 dB/ 10 cm	M22-AMC-XAM
Indicator with buzzer, black pulsed tone, 18–30 Vac/Vdc	83 dB/ 10 cm	M22-AMC-XAMP

M22-XAM



Components

Description	Decibel Rating	Catalog Number
Indicator without buzzer, black	83 dB/ 10 cm	M22-AMC
Buzzer only, continuous tone, 18–30 Vac/Vdc	83 dB/ 10 cm	M22-XAM
Buzzer only, pulsed tone, 18–30 Vac/Vdc	83 dB/ 10 cm	M22-XAMP

Through-the-Door Operators ^①

M22-DZ-B-X6

Complete Devices



Color	Inscription	Catalog Number
Blue	—	M22-DZ-B
	RESET	M22-DZ-B-GB14
	Ⓡ	M22-DZ-B-X6
Red	—	M22-DZ-R
	Ⓢ	M22-DZ-R-X0
	STOP	M22-DZ-R-GB0

M22-DZ-X

Buttonless Operator



Bezel	Catalog Number
Silver	M22-DZ-X

M22-XD-B

Button Plates ^②

Color	Inscription	Catalog Number
Blue	—	M22-XD-B ^③
	RESET	M22-XD-B-GB14
	Ⓡ	M22-XD-B-X6
Red	—	M22-XD-R ^③
	Ⓢ	M22-XD-R-X0
	STOP	M22-XD-R-GB0

Bulkhead Interfaces

M22-USB-SA

USB Socket ^{④⑤}

Description	Catalog Number
Used for USB connection USB 2.0 Type A plug IP65 when closed IP20 when connected	M22-USB-SA

M22-RJ45-SA

RJ45 Socket ^⑥

Description	Catalog Number
Used for RJ45 Ethernet connection IP65 when closed IP20 when connected	M22-RJ45-SA

Notes

- ① The pushrod is 3.24 in long and can be cut to length.
- ② Any combination of plate color and inscription is available.
- ③ Minimum order quantity of (10).
- ④ USB interface is complete with 2-ft-long USB cable.
- ⑤ UL and CSA pending.
- ⑥ RJ45 interface is an eight-wire connector.

ASi Adapter Modules

M22-ASI



Complete Devices

Description	Catalog Number
ASi adapter module	M22-ASI
ASi adapter module for base mounting	M22-ASI-C
ASi adapter module for E-stop	M22-ASI-S
ASi adapter module for E-stop base mounting	M22-ASI-CS

4

Complete Devices

Operator, Base and Contact Blocks ^①

FAK-S-KC11-I



Button Color	Contact Block Configuration ^②	Catalog Number
Momentary		
Black	1NO-1NC	FAK-S-KC11-I
Red	1NO-1NC	FAK-R-KC11-I
Yellow	1NO-1NC	FAK-Y-KC11-I

FAK-R-V-KC01-IY



Button Color	Contact Block Configuration ^②	Catalog Number
Maintained		
Red	NC	FAK-R-V-KC01-IY
	2NC	FAK-R-V-KC02-IY
	1NO-2NC	FAK-R-V-KC12-IY
	1NO-1NC	FAK-R-V-KC11-IY



Notes

^① For complete listing of available contact blocks, see Accessories, Pages V9-T4-31 to V9-T4-36.

^② All NC contact blocks are positively driven contact. ⊖

Accessories

Mounting Adapters

	Description	Catalog Number
M22-A	Contact block mounting adapter. ①	M22-A
		
M22-A4	Contact block mounting adapter, four-position (for use with four-way pushbuttons, joysticks and four-position selector switches only). ①	M22-A4
		
M22-LS	Allows mounting of M22 pushbuttons to LS-Titan limit switch bodies (for the full LS-Titan catalog section, see PG08301004E). ①	M22-LS
		

Contact Blocks

M22-K10;



Mounting Location	Terminal Type	Contact Configuration ②	Package Qty.	Catalog Number
Front	Screw	NO	1	M22-K10
		NO	25	M22-K10-B25
		NO	100	M22-K10-B100
		NO, early-make	1	M22-K10P
		NC	1	M22-K01
		NC	25	M22-K01-B25
		NC	100	M22-K01-B100
		NC, late-break	1	M22-K01D
Base		NO	1	M22-KC10
		NO	25	M22-KC10-B25
		NO	100	M22-KC10-B100
		NC	1	M22-KC01
		NC	25	M22-KC01-B25
		NC	100	M22-KC01-B100
Front	Spring cage	NO	1	M22-CK10
		NC	1	M22-CK01
		NC, late-break	1	M22-CK01D
		2NO ③	1	M22-CK20
		2NC ③	1	M22-CK02
		NO-NC ③	1	M22-CK11
Base		NO	1	M22-CKC10
		NC	1	M22-CKC01

Notes

- ① Included with each operator.
- ② All NC contact blocks are positively driven contact. ⊖
- ③ Not stackable.

M22-LED-W



Light Units

Terminal Type	Mounting Location	LED Color	Light Unit Voltage	Catalog Number	
Screw	Front	White	12–30 Vac/Vdc	M22-LED-W	
		Red		M22-LED-R	
		Green		M22-LED-G	
		Blue		M22-LED-B	
		White	85–264 Vac	M22-LED230-W	
		Red		M22-LED230-R	
		Green		M22-LED230-G	
		Blue		M22-LED230-B	
		White	207–264 Vac	M22-LED230H-W	
		Red		M22-LED230H-R	
		Green		M22-LED230H-G	
		Blue		M22-LED230H-B	
	Base	White	12–30 Vac/Vdc	M22-LEDC-W	
		Red		M22-LEDC-R	
		Green		M22-LEDC-G	
		Blue		M22-LEDC-B	
		White	85–264 Vac	M22-LEDC230-W	
		Red		M22-LEDC230-R	
		Green		M22-LEDC230-G	
		Blue		M22-LEDC230-B	
		White	207–264 Vac	M22-LEDC230H-W	
		Red		M22-LEDC230H-R	
		Green		M22-LEDC230H-G	
		Blue		M22-LEDC230H-B	
Spring cage	Front	White	12–30 Vac/Vdc	M22-CLED-W	
		Red		M22-CLED-R	
		Green		M22-CLED-G	
		Blue		M22-CLED-B	
		White	85–264 Vac	M22-CLED230-W	
		Red		M22-CLED230-R	
		Green		M22-CLED230-G	
		Blue		M22-CLED230-B	
		Base	White	12–30 Vac/Vdc	M22-CLEDC-W
			Red		M22-CLEDC-R
			Green		M22-CLEDC-G
			Blue		M22-CLEDC-B
	White		85–264 Vac	M22-CLEDC230-W	
	Red			M22-CLEDC230-R	
	Green			M22-CLEDC230-G	
	Blue			M22-CLEDC230-B	

M22-XLED60**LED Resistor and Test Elements**

Terminal Type	Mounting Location	Element Type	Voltage	Catalog Number
Screw	Front	Resistor ①②	42–60 Vac/Vdc	M22-XLED60
			220 Vdc	M22-XLED220
		Test	12–240 Vac/Vdc	M22-XLED-T
			85–264 Vac	M22-XLED230-T

Legend Plate Holders and Inserts, Pushbuttons and Double Pushbuttons ③**M22S-ST-X**

Description	Inscription	Catalog Number
Legend plate holder, without legend plate insert, for pushbuttons	—	M22S-ST-X
Legend plate holder, without legend plate insert, for double pushbuttons	—	M22S-STDD-X

M22-XST-GB0

Legend plate insert	—	M22-XST
	Custom	M22-XST-ETCH ④
	STOP	M22-XST-GB0
	START	M22-XST-GB1
	OFF	M22-XST-GB5
	ON	M22-XST-GB6
	RUN	M22-XST-GB7
	FAULT	M22-XST-GB8
	OFF ON	M22-XST-GB10
	MAN. AUTO	M22-XST-GB11
	MAN. O AUTO	M22-XST-GB12
	HAND AUTO	M22-XST-D11
	HAND O AUTO	M22-XST-D12
	1	M22-XST-X52
2	M22-XST-X53	
0 I	M22-XST-X88	
0 - I	M22-XST-X89	
I O II	M22-XST-X93	

Notes







- ① Resistor units to be used with 12–30V light units.
- ② Refer to **IL04716002E** for use of resistor elements in series for higher DC voltage.
- ③ Legend plates are IP66 and NEMA 4X/13.
- ④ When ordering, specify inscription per catalog number suffix from the Symbols Library (see Volume 7—Logic Control, Operator Interface and Connectivity Solutions, CA08100008E, Tab 1) into the Order Notes. For example, M22-XD-S-ETCH; Order Notes: Mark with symbol X91, Line item #__.

Example

To order a legend plate for a pushbutton with non-standard markings (FORWARD):

1. Select legend plate holder—M22S-ST-X.
2. Select legend plate insert—M22-XST-ETCH.
3. Select FORWARD from the Symbols Library, Volume 7—Logic Control, Operator Interface and Connectivity Solutions, CA08100008E, Tab 1, identified by GB15 suffix.
4. Indicate on the order form in the order notes—suffix GB15, line item # __ .

Legend Plates, Complete ①



	Description	Inscription	Catalog Number
M22S-ST-GB0 	For use with pushbuttons and indicating lights	Legend plate holder with insert	M22S-ST-GB0
		STOP	M22S-ST-GB1
		START	M22S-ST-GB5
		OFF	M22S-ST-GB6
		ON	M22S-ST-GB7
		RUN	M22S-ST-GB8
		FAULT	M22S-ST-X52
		1	M22S-ST-X53
		2	M22S-ST-GB10
		OFF ON	M22S-ST-GB11
		MAN. AUTO	M22S-ST-GB12
		MAN. O AUTO	M22S-ST-D11
HAND AUTO	M22S-ST-D12		
HAND O AUTO	M22S-ST-X88		
O I	M22S-ST-X89		
O - I	M22S-ST-X93		
I O II	M22-XZK		
M22-XZK 	Emergency-stop operators	Rectangular yellow legend plate	M22-XZK
		Custom	M22-XZK-ETCH ②
		EMERGENCY-STOP	M22-XZK-GB99
M22-XYK 	Emergency-stop operators	Square yellow legend plate	M22-XYK
		Custom	M22-XYK-ETCH ②
		EMERGENCY-STOP four-language	M22-XYK1
		EMERGENCY-STOP (top and bottom)	M22-XYK5
		Round yellow legend plate, 90 mm	M22-XAK
M22-XBK1 	Emergency-stop operators	Round yellow legend plate, 90 mm	M22-XAK
		Custom	M22-XAK-ETCH ②
		EMERGENCY-STOP four-language	M22-XAK1
		EMERGENCY-STOP (top and bottom)	M22-XAK5
		Round yellow legend plate, 60 mm	M22-XBK
M22-XBK1 	Emergency-stop operators	Round yellow legend plate, 60 mm	M22-XBK
		Custom	M22-XBK-ETCH ②
		EMERGENCY-STOP four-language	M22-XBK1
		EMERGENCY-STOP (top and bottom)	M22-XBK5
		Round yellow legend plate, 60 mm	M22-XBK
M22-XBK1 	Emergency-stop operators	Round yellow legend plate, 60 mm	M22-XBK
		Custom	M22-XBK-ETCH ②
		EMERGENCY-STOP four-language	M22-XBK1
		EMERGENCY-STOP (top and bottom)	M22-XBK5
		Round yellow legend plate, 60 mm	M22-XBK
M22-XCK1 	Four-way pushbutton, joystick and four-position selector switches	Silver square legend plate	M22-XCK
		Custom	M22-XCK-ETCH ②
		Four directional arrows	M22-XCK1
		0-1-0-2-0-3-0-4	M22-XCK2
		Two directional arrows	M22-XCK3

Notes

① Legend plates are IP66 and NEMA 4X/13.

② When ordering, specify inscription per catalog number suffix from the Symbols Library (see Volume 7—Logic Control, Operator Interface and Connectivity Solutions, CA08100008E, Tab 1) into the Order Notes. For example, M22-XD-S-ETCH; Order Notes: Mark with symbol X91, Line item #_.

Surface Mounting Enclosures ①

	Description	Catalog Number
	Yellow top, black base for emergency-stop operators	M22-IY1-PG
	One-element enclosure	M22-I1-PG
	Two-element enclosure	M22-I2-PG
	Three-element enclosure	M22-I3-PG
	Four-element enclosure	M22-I4-PG
	Six-element enclosure	M22-I6-PG
	M20 connecting screw	M22-XI
	M20 cord grip	V-M20





Flush Mounting Plates, Aluminum

	Finish	Rating	Catalog Number
	One Hole		
	Yellow paint for emergency-stop operators	—	M22-EY1
	Gray anodized	IP65	M22-E1
	Two Holes		
	Gray anodized	IP65	M22-E2
	Three Holes		
	Gray anodized	IP65	M22-E3
	Four Holes		
	Gray anodized	IP65	M22-E4
	Five Holes		
	Gray anodized	IP65	M22-E5
	Six Holes		
	Anodized	IP40	M22-E6



Shrouds, Plastic

	Description	Rating	Catalog Number
	One-element	IP55	M22-H1
	Two-element	IP55	M22-H2
	Three-element	IP55	M22-H3
	Four-element	IP40	M22-H4
	Five-element	IP40	M22-H5
	Six-element	IP40	M22-H6
	Mounting plate	—	M22-XE5
	Plaster keys for flush mounting	—	M22-UPE

Selector Switch Accessories

	Description	Catalog Number
	Plunger bridge ②	M22-XW
	Key cover	M22-XWS
	Key withdraw adapter ③	M22-XC-R
	Coding adapter	M22-XC-Y
	Guard ring	M22-XGWK

Emergency Stop Operator Accessories

	Description	Catalog Number
	Yellow guard ring	M22-XGVP
	Gray guard ring	M22G-XGPV
	Sealing shroud	M22-PL-PV

Blanking Plugs

	Color	Catalog Number
	Gray	M22-B
	Black	M22S-B

Notes

- ① Requires use of base mounted contact blocks.
- ② Plunger needed to actuate center-mounted contact blocks. Used for non-illuminated three-position selector switches only.
- ③ Enables a keyed selector switch to be set to user-selected key withdraw position.

4.1

Operator Interface

Pushbutton and Pilot Devices

4

Mounting Accessories

	Description	Catalog Number
	Telescopic clip with top-hat rail	M22-TC
	Telescopic clip	M22-TA
	Telescopic clip extension	M22-TCV
	DIN rail mounting adapter	M22-IVS
	Mounting ring	M22-GR
	Mounting ring tool	M22-MS
	Adapter ring set for 30 mm holes	M22S-R30

M22-T-D and M22-T-DD



Protective Diaphragm

For Use with ...	Catalog Number
Flush pushbuttons and indicating lights	M22-T-D
Double pushbuttons	M22-T-DD

M22-ADC4



Dust Covers

Description	Catalog Number
Contact block dust cover	M22-XKDP
Operator dust cover, max three contact blocks	M22-ADC
Operator dust cover, max four contact blocks	M22-ADC4

Kits

Description	Catalog Number
Includes one each: M22-XW, M22-XC-R, M22-XC-Y, M22S-B, M22-A, M22-XD-SWRGYB	M22-KT1

10250T—30 mm Pushbuttons



Features

- Heavy-duty zinc die-cast construction
- Enclosed silver contacts with reliability nibs
- Diaphragm seals with drainage holes
- Grounding nibs on the operator casing

Product Selection

10250T—30 mm Pushbuttons

Flush Button



Extended Button



Mushroom Button



Jumbo Mushroom



Non-Illuminated Pushbutton Units—UL (NEMA) Type 3, 3R, 4, 4X, 12, 13

Contact Type	Button Color	Catalog Number			
		Flush Button	Extended Button	Mushroom Button	Jumbo Mushroom ^①
1NO	Black	10250T23B	10250T25B	10250T26B	10250T27B
	Red	10250T23R	10250T112-53	10250T122-53	10250T172-53
	Green	10250T23G	10250T25G	10250T26G	10250T27G
	Yellow	10250T23Y	10250T25Y	10250T26Y	10250T27Y
	Red—Engraved EMERG. STOP	—	—	—	10250T17213-53
1NC	Black	10250T101-51	10250T111-51	10250T121-51	10250T171-51
	Red	10250T102-51	10250T25R	10250T26R	10250T27R
	Green	10250T103-51	10250T113-51	10250T123-51	10250T173-51
	Yellow	10250T104-51	10250T120-51	10250T124-51	10250T174-51
	Red—Engraved EMERG. STOP	—	—	—	10250T29
1NO-1NC	Black	10250T30B	10250T31B	10250T32B	10250T33B
	Red	10250T30R	10250T31R	10250T32R	10250T33R
	Green	10250T30G	10250T31G	10250T32G	10250T33G
	Yellow	10250T30Y	10250T31Y	10250T32Y	10250T33Y
	Red—Engraved EMERG. STOP	—	—	—	10250T33
2NO	Black	10250T101-2	10250T111-2	10250T121-2	10250T171-2
	Red	10250T102-2	10250T112-2	10250T122-2	10250T172-2
	Green	10250T103-2	10250T113-2	10250T123-2	10250T173-2
	Yellow	10250T104-2	10250T120-2	10250T124-2	10250T174-2
	Red—Engraved EMERG. STOP	—	—	—	10250T17213-2
2NC	Black	10250T101-3	10250T111-3	10250T121-3	10250T171-3
	Red	10250T102-3	10250T112-3	10250T122-3	10250T172-3
	Green	10250T103-3	10250T113-3	10250T123-3	10250T173-3
	Yellow	10250T104-3	10250T120-3	10250T124-3	10250T174-3
	Red—Engraved EMERG. STOP	—	—	—	10250T17213-3

Note

① Anodized aluminum head is not suitable for use in ultraviolet light applications.

24V Full Voltage Illuminated Pushbutton



4

Illuminated Pushbutton Units—UL (NEMA) Type 3, 3R, 4, 4X, 12, 13

Type	Voltage	Color	LED/Lamp Number	Catalog Number				
				Illuminated Pushbutton 1N0	1N0-1NC	1NC		
LED Lamp								
Full voltage	24 Vac/Vdc	Red	Bayonet base	10250T397LRD24-53	10250T397LRD24-1	10250T397LRD24-51		
				Green	10250T397LGD24-53	10250T397LGD24-1	10250T397LGD24-51	
				Amber	10250T397LAD24-53	10250T397LAD24-1	10250T397LAD24-51	
				Yellow	10250T397LYD24-53	10250T397LYD24-1	10250T397LYD24-51	
				Blue	10250T397LLD24-53	10250T397LLD24-1	10250T397LLD24-51	
				White	10250T397LWD24-53	10250T397LWD24-1	10250T397LWD24-51	
	120 Vac	Red		10250T397LRD2A-53	10250T397LRD2A-1	10250T397LRD2A-51		
				Green	10250T397LGD2A-53	10250T397LGD2A-1	10250T397LGD2A-51	
				Amber	10250T397LAD2A-53	10250T397LAD2A-1	10250T397LAD2A-51	
				Yellow	10250T397LYD2A-53	10250T397LYD2A-2	10250T397LYD2A-51	
				Blue	10250T397LLD2A-53	10250T397LLD2A-1	10250T397LLD2A-51	
				White	10250T397LWD2A-53	10250T397LWD2A-1	10250T397LWD2A-51	
	Transformer	120 Vac	Red		10250T411LRD06-53	10250T411LRD06-1	10250T411LRD06-51	
					Green	10250T411LGD06-53	10250T411LGD06-1	10250T411LGD06-51
					Amber	10250T411LAD06-53	10250T411LAD06-1	10250T411LAD06-51
					Yellow	10250T411LYD06-53	10250T411LYD06-1	10250T411LYD06-51
					Blue	10250T411LLD06-53	10250T411LLD06-1	10250T411LLD06-51
					White	10250T411LWD06-53	10250T411LWD06-1	10250T411LWD06-51
Incandescent Lamp								
Full voltage	24 Vac/Vdc	Red	#757	10250T476C21-53	10250T476C21-1	10250T476C21-51		
				Green	10250T476C22-53	10250T476C22-1	10250T476C22-51	
				Amber	10250T476C43-53	10250T476C43-1	10250T476C43-51	
				Yellow	10250T476C23-53	10250T476C23-1	10250T476C23-51	
				Blue	10250T476C24-53	10250T476C24-1	10250T476C24-51	
				Clear	10250T476C25-53	10250T476C25-1	10250T476C25-51	
	Resistor	120 Vac/Vdc	Red	120MB	10250T476C26-53	10250T476C26-1	10250T476C26-51	
					Green	10250T471C21-53	10250T471C21-1	10250T471C21-51
					Amber	10250T471C22-53	10250T471C22-1	10250T471C22-51
					Yellow	10250T471C43-53	10250T471C43-1	10250T471C43-51
					Blue	10250T471C23-53	10250T471C23-1	10250T471C23-51
					Clear	10250T471C24-53	10250T471C24-1	10250T471C24-51
Transformer	120 Vac	Red	#755	10250T471C25-53	10250T471C25-1	10250T471C25-51		
				Green	10250T471C26-53	10250T471C26-1	10250T471C26-51	
				Amber	10250T75R ①	10250T76R ①	10250T77R ①	
				Yellow	10250T75G ①	10250T76G ①	10250T77G ①	
				Blue	10250T75A ①	10250T76A ①	10250T77A ①	
				Clear	10250T75Y ①	10250T76Y ①	10250T77Y ①	
Transformer	120 Vac	Red	#755	10250T75B ①	10250T76B ①	10250T77B ①		
				Green	10250T75C ①	10250T76C ①	10250T77C ①	
				Amber	10250T75W ①	10250T76W ①	10250T77W ①	
				Yellow				
				Blue				
				Clear				

Note

① For flashing module catalog number 10250TFL1, add suffix code **FM** to listed catalog number. Example: 10250T75R**FM**.

Indicating Light Units

24V Full Voltage
Illuminated Light120 Vac Transformer
Pres Test

Indicating Light Units—UL (NEMA) Type 3, 3R, 4, 4X, 12, 13 ①

Type	Voltage	Color	LED/Lamp Number	Catalog Number 24V Full Voltage Indicating Light—Red Catalog Number 10250T206NC1N	Catalog Number 120V AC Transformer Pres Test—Green Catalog Number 10250T74NG		
LED Lamp							
Full voltage	24 Vac/Vdc	Red	Bayonet base	10250T197LRP24	10250T297LRP24		
				10250T197LGP24	10250T297LGP24		
				10250T197LAP24	10250T297LAP24		
				10250T197LYP24	10250T297LYP24		
				10250T197LLP24	10250T297LLP24		
				10250T197LWP24	10250T297LWP24		
		120 Vac	Red	10250T197LRP2A	10250T297LRP2A		
				10250T197LGP2A	10250T297LGP2A		
				10250T197LAP2A	10250T297LAP2A		
				10250T197LYP2A	10250T297LYP2A		
				10250T197LLP2A	10250T297LLP2A		
				10250T197LWP2A	10250T297LWP2A		
		120 VAC	Red	10250T181LRP06	10250T221LRP06		
				10250T181LGP06	10250T221LGP06		
				10250T181LAP06	10250T221LAP06		
				10250T181LYP06	10250T221LYP06		
				10250T181LLP06	10250T221LLP06		
				10250T181LWP06	10250T221LWP06		
Incandescent Lamp							
Full voltage	24 Vac/Vdc	Red	#757	10250T206NC1N	10250T235NC21		
				10250T206NC2N	10250T235NC22		
				10250T206NC19N	10250T235NC43		
				10250T206NC3N	10250T235NC23		
				10250T206NC4N	10250T235NC24		
				10250T206NC5N	10250T235NC25		
		120 Vac/Vdc		Red	120MB	10250T201NC1N	10250T231NC21
						10250T201NC2N	10250T231NC22
						10250T201NC19N	10250T231NC43
						10250T201NC3N	10250T231NC23
						10250T201NC4N	10250T231NC24
						10250T201NC5N	10250T231NC25
Transformer ②	120 VAC	Red	#755	10250T34R	10250T74NR		
				10250T34G	10250T74NG		
				10250T34A	10250T74NA		
				10250T34Y	10250T74NY		
				10250T34B	10250T74NB		
				10250T34C	10250T74NC		
				10250T34W	10250T74NW		

Notes

① Standard indicating lights are rated UL (NEMA) 3S as well.

② For flashing lamp, add letter **F** to listed catalog number. Example: 10250T34RF.

4.1













Operator Interface

Pushbutton and Pilot Devices

4

Two-Position Push-Pull Units—UL (NEMA) Type 3, 3R, 4, 4X, 12, 13

Operator Position ①







	Operator Position ①		Button Type/Color	Contact Type	Mounting Location		Catalog Number
	Pull	Push			A	B	
Two-Position Maintained Push, Maintained Pull							
10250T5B62-1X 	0	X	40 mm/red	1NO			10250T5B62-1X
	X	0		1NC			
10250T5B63-1X 	0	X	40 mm engraved EMERG. STOP/red	1NO			10250T5B63-1X
	X	0		1NC			
10250T5J63-1X 	0	X	65 mm aluminum engraved EMERG. STOP/red	1NO			10250T5J63-1X
	X	0		1NC			
10250ED1080-2 	0	X	65 mm aluminum engraved EMERG. STOP/red Special security jumbo mushroom head	1NO			10250ED1080-2
	X	0		1NC			

Three-Position Push-Pull Units—UL (NEMA) Type 3, 3R, 4, 4X, 12, 13

Operator Position ①

10250T_



	Operator Position ①			Button Type/Color	Contact Type	Mounting Location		Catalog Number
	Pull	Intermediate	Push			A	B	
Three-Position Maintained Push, Momentary Pull								
X	0	0	40 mm/black	1NC			10250T9B60-3X	
	X	0	40 mm/red	1NC				
	X	X	40 mm engraved EMERG. STOP/red					
Three-Position Momentary Push, Momentary Pull								
X	0	0	40 mm/black	1NC			10250T4B60-3X	
	X	X	40 mm/red	1NC				
0	0	X	40 mm/black	1NO			10250T10B60-1X	
	X	0	40 mm/red	1NC				

Note

① X = closed circuit, 0 = open circuit.

Two-Position Push-Pull Operator



Two-Position Illuminated Maintained Push, Maintained Pull—UL (NEMA) Type 3, 3R, 4, 4X, 12, 13

Operator Position ①

Maintained—Pull	Maintained—Push	Lamp	Type	Voltage	Contact Type	Mounting Location A B	LED/Lamp Number	Red Standard Push-Pull Catalog Number
0 X	X 0	LED	Full Voltage	24 Vac/Vdc	1NO		Bayonet base	10250T597LRD24-1X
				120 Vac/Vdc	1NC			10250T597LRD2A-1X
			Transformer	24 Vac				10250T589LRD06-1X
				120 Vac				10250T563LRD06-1X
0 X	X 0	Incandescent	Full voltage	24 Vac/Vdc	1NO		#757	10250T579C47-1X
			Resistor	120 Vac/Vdc	1NC		120MB	10250T580C47-1X
			Transformer	24 Vac			#755	10250T589C47-1X
				120 Vac				10250T563C47-1X

Three-Position Push-Pull Operator



Three-Position Illuminated Momentary Push, Momentary Pull—UL (NEMA) Type 3, 3R, 4, 4X, 12, 13

Operator Position ①

Momentary—Pull	Maintained—Intermediate	Momentary—Push	Lamp	Type	Voltage	Contact Type	Mounting Location A B	LED/Lamp Number	Red Standard Push-Pull Catalog Number
0 X	0 0	X 0	LED	Full voltage	24 Vac/Vdc	1NO		Bayonet base	10250T1097LRD24-1X
					120 Vac	1NC			10250T1097LRD2A-1X
				Transformer	24 Vac				10250T1089LRD06-1X
					120 Vac				10250T1063LRD06-1X
X X	0 X	0 0		Full voltage	24 Vac/Vdc	1NC		Bayonet base	10250T497LRD24-3X
					120 Vac	1NC			10250T497LRD2A-3X
				Transformer	24 Vac				10250T489LRD06-3X
					120 Vac				10250T463LRD06-3X
0 X	0 0	X 0	Incandescent	Full voltage	24 Vac/Vdc	1NO		#757	10250T1079C47-1X
				Resistor	120 Vac	1NC		120MB	10250T1080C47-1X
				Transformer	24 Vac			#755	10250T1089C47-1X
					120 Vac				10250T1063C47-1X
X X	0 X	0 0		Full voltage	24 Vac/Vdc	1NC		#757	10250T479C47-3X
				Resistor	120 Vac	1NC		120MB	10250T480C47-3X
				Transformer	24 Vac			#755	10250T489C47-3X
					120 Vac				10250T463C47-3X

Note

① X = closed circuit, 0 = open circuit.

4.1

Operator Interface

Pushbutton and Pilot Devices

Three-Position Push-Pull Operator



Three-Position Illuminated Maintained Push, Momentary Pull—UL (NEMA) Type 3, 3R, 4, 4X, 12, 13

Operator Position^①

Momentary— Pull	Maintained— Intermediate	Momentary— Push	Lamp	Type	Voltage	Contact Type	Mounting Location		LED/ Lamp Number	Red Standard Push-Pull Catalog Number
							A	B		
X	0	0	LED	Full voltage	24 Vac/Vdc	1NC	o o	Bayonet base	10250T997LRD24-3X	
X	X	0			120 Vac	1NC	o o		10250T997LRD2A-3X	
					Transformer	24 Vac			10250T989LRD06-3X	
					120 Vac				10250T963LRD06-3X	
X	0	0	Incan- descent	Full voltage	24 Vac/Vdc	1NC	o o	#757	10250T979C47-3X	
X	X	0			120 Vac	1NC	o o		10250T980C47-3X	
					Transformer	24 Vac			#755	10250T989C47-3X
					120 Vac				10250T963C47-3X	

4

Potentiometers

Vertical or Horizontal^② One-Hole Mounting

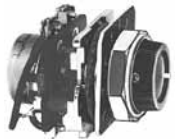

Potentiometer with Knob and Standard Dial Plate—Linear Type ±10%— UL (NEMA) Type 3, 3R, 4, 12, 13

Potentiometer Ohms	Catalog Number
2 Watt (60V Max.) Single Potentiometer with Standard Aluminum Dial Plate^{③④}	
1000	10250T331
2500	10250T332
5000	10250T338
10000	10250T333
25000	10250T334
50000	10250T335
Operator only ^⑤	10250T330
Alternative—black plastic large legend with standard markings	E34LP99

Notes

- ① X = closed circuit, 0 = open circuit.
- ② Shown with standard aluminum dial plate.
- ③ Large dial plate with space for legend is available at no charge. To order, add suffix **36** to catalog number. Example: 10250T331**36**. To order separately, see footnote ④ below.
- ④ Large dial plate has space at top for 15 letters. 3/32 in high. For custom stamped legend plates, order legend plate as separate item **10250TR30** and specify stamping.
- ⑤ For use with commercially purchased potentiometers having shaft dimensions per dimension drawing

Selector Switch Units

Two-Position Maintained Switch



Two-Position Selector Switch—UL (NEMA) Type 3, 3R, 4, 4X, 12, 13

Operator Position ①		Operator Action ②	Contact Type	Mounting Location		Non-Illuminated		Illuminated—120V Transformer	
X	O			A	B	Black Knob Catalog Number ③	Black Lever Catalog Number ③	Red Knob Catalog Number ③	Red Lever Catalog Number ③
X	O		1NC			<u>10250T20KB</u>	<u>10250T20LB</u>	<u>10250ED1117-KR</u>	<u>10250ED1117-LR</u>
O	X		1NO						

Three-Position Maintained Switch



Three-Position Selector Switch—UL (NEMA) Type 3, 3R, 4, 4X, 12, 13

Operator Position ①			Operator Action ②	Contact Type	Mounting Location		Non-Illuminated		Illuminated—120V Transformer	
X	O	O			A	B	Black Knob Catalog Number ③	Black Lever Catalog Number ③	Red Knob Catalog Number ③	Red Lever Catalog Number ③
X	O	O		1NO			<u>10250T21KB</u>	<u>10250T21LB</u>	<u>10250ED1117-2KR</u>	<u>10250ED1117-2LR</u>
O	O	X		1NO						
X	O	O		1NO			<u>10250T22KB</u>	<u>10250T22LB</u>	<u>10250ED1117-3KR</u>	<u>10250ED1117-3LR</u>
O	X	O		2NC (Series)						
O	O	X		1NO						

Four-Position Maintained Switch



Four-Position Selector Switch—UL (NEMA) Type 3, 3R, 4, 4X, 12, 13

Operator Position ①				Operator Action ②	Contact Type	Mounting Location		Non-Illuminated		Illuminated—120V Transformer	
X	O	O	O			A	B	Black Knob Catalog Number ③	Black Lever Catalog Number ③	Red Knob Catalog Number ③	Red Lever Catalog Number ③
X	O	O	O		1NC			<u>10250T46KB</u>	<u>10250T46LB</u>	<u>10250ED1117-4KR</u>	<u>10250ED1117-4LR</u>
O	X	O	O		1NO						
O	O	X	O		1NO						
O	O	O	X		1NC						

Color Selection

Illuminated						Non-Illuminated					
Color	Code Letter	Color	Code Letter	Color	Code Letter	Color	Code Letter	Color	Code Letter	Color	Code Letter
Red	R	White	W	Amber	A	Black	B	Green	G	Blue	L
Green	G	Blue	B	Clear	C	Red	R	White	W	Orange	O

Notes

① X = closed circuit, O = open circuit.

② M = Maintained.

③ To order different type or color selector switch, substitute the underlined character with appropriate suffix code from the Color Selection table. Example: 10250T20KG.

Legend Plates

Square Legend Plate



1/2 Round Legend Plate



4

For Pushbutton Operators and Indicating Lights—Standard

Legend	Color of Field	Square ^① Catalog Number	1/2 Round Catalog Number	Legend	Color of Field	Square ^① Catalog Number	1/2 Round Catalog Number
Blank—see table on Page V9-T4-46.							
Letters on Legend Plates Below are 3/16 in High							
CLAMP	Black	10250TS90	10250TM90	OFF	Red	10250TS24	10250TM24
CLOSE		10250TS73	10250TM11	ON	Black	10250TS25	10250TM25
DOWN		10250TS74	10250TM12	OPEN		10250TS26	10250TM26
EMERG. STOP	Red	10250TS13	10250TM13	OUT		10250TS27	10250TM27
FAST	Black	10250TS75	10250TM14	POWER ON		10250TS80	10250TM80
FASTER		10250TS87	10250TM87	RAISE		10250TS28	10250TM28
FEEDER ON		10250TS94	10250TM94	READY		10250TS86	10250TM86
FEEDER OFF		10250TS95	10250TM95	RESET		10250TS29	10250TM29
FORWARD		10250TS15	10250TM15	REVERSE		10250TS30	10250TM30
HIGH		10250TS16	10250TM16	RUN		10250TS31	10250TM31
IN		10250TS17	10250TM17	SAFE		10250TS85	10250TM85
INCH		10250TS18	10250TM18	SLOW		10250TS32	10250TM32
JOG		10250TS19	10250TM19	SLOWER		10250TS88	10250TM88
JOG FOR.		10250TS20	10250TM20	START		10250TS33	10250TM33
JOG REV.		10250TS21	10250TM21	STOP	Red	10250TS34	10250TM34
LOW		10250TS22	10250TM22	TEST	Black	10250TS83	10250TM83
LOWER		10250TS23	10250TM23	TRANSFER		10250TS93	10250TM93
LUBE-FAIL		10250TS92	10250TM92	TRIP		10250TS84	10250TM84
MOTOR RUN		10250TS81	10250TM81	UNCLAMP		10250TS91	10250TM91
MOTOR STOP		10250TS82	10250TM82	UP		10250TS35	10250TM35

Blank Plastic Legend Plates—Square

Color Lettering	Field	Standard Catalog Number	Jumbo ^② Catalog Number	Extra Large Catalog Number
Black	White or silver ^③	10250TSP76	10250TLP76	10250TEP76
White	Red or black ^③	10250TSP77	10250TLP77	10250TEP77

Notes

- ① Square legend plates have a satin aluminum field. Color is on lower portion.
- ② Cannot be used on cast enclosures except for top row. Suitable for most sheet metal enclosures.
- ③ If legend plate is to be engraved, specify field color required.

Square Legend Plate



1/2 Round Legend Plate



For Selector Switch and Roto-Push Operators—Standard Size

Legend	Color of Field	Square ^① Catalog Number	1/2 Round Catalog Number	Legend	Color of Field	Square ^① Catalog Number	1/2 Round Catalog Number
Blank—see table on Page V9-T4-46.							
Two-Position—5/32 in High Lettering				Three-Position—1/8 in High Lettering			
FOR. REV.	Black	10250TS38	10250TM38	AUTO OFF HAND	Black	10250TS49	10250TM49
HAND AUTO		10250TS39	10250TM39	FOR. OFF REV.		10250TS50	10250TM50
HIGH LOW		10250TS40	10250TM40	FOR. SAFE REV.		10250TS69	10250TM69
JOG RUN		10250TS41	10250TM41	HAND OFF AUTO		10250TS51	10250TM51
MAN. AUTO		10250TS67	10250TM67	MAN. OFF AUTO		10250TS68	10250TM68
OFF ON		10250TS42	10250TM42	OPEN OFF CLOSE		10250TS53	10250TM53
OPEN CLOSE		10250TS43	10250TM43	RUN SAFE JOG		10250TS70	10250TM70
RUN JOG		10250TS44	10250TM44	UP OFF DOWN		10250TS54	10250TM54
SAFE RUN		10250TS45	10250TM45	ON STOP SAFE	Red	10250TS71	10250TM71
START JOG		10250TS46	10250TM46				
START STOP		10250TS47	10250TM47				
UP DOWN		10250TS48	10250TM48				

70 mm Round—Plastic Legend Plate



45 mm and 70 mm Plastic—Round

Color	Lettering	Field	Catalog Number
45 mm			
Blank		Yellow or red ^②	10250TRP78
70 mm			
Blank		Yellow or red ^②	10250TRP76
Red EMERG. STOP		Yellow	10250TRP79

For Push-Pull Units ^③

Legend	Color of Field	Square ^① Catalog Number	1/2 Round Catalog Number
Standard Size—Letters on Legend Plates Below are 3/32 in High			
PULL START/PUSH STOP	Green/red	10250TPP2	10250TR2
PUSH ON/PULL OFF	Black	10250TPP5	10250TR5
PULL OPEN/PUSH CLOSE	Black	10250TPP8	10250TR8
PULL UP/PUSH DOWN	Black	10250TPP11	10250TR11
Jumbo Size—Letters on Legend Plates Below are 1/8 in High			
PULL START/PUSH STOP	Green/red	10250TPP3	10250TR3
PULL ON/PUSH OFF	Black	10250TPP6	10250TR6
PULL OPEN/PUSH CLOSE	Black	10250TPP9	10250TR9
PULL UP/PUSH DOWN	Black	10250TPP12	10250TR12

Notes

- ^① Square legend plates have a satin aluminum field. Color is on lower portion.
^② If legend plate is to be engraved, specify field color required.
^③ All push-pull legend plates include the symbols ≠ ∅ in the center of the plate.

Blank and Custom Engraved Legend Plates



Style	Color					Four-Position Selector Switch		Push-Pull with Symbols ^④	
		Small Catalog Number	Standard Catalog Number	Jumbo ^① Catalog Number	Extra Large ^② Catalog Number	Custom ^③ Catalog Number	Standard Catalog Number	Standard Catalog Number	Jumbo ^① Catalog Number
Square ^⑤	Black	10250TMS36	10250TS36	10250TL36	—	10250TS76	10250TS72	10250TPP17	10250TPP18
	Red	10250TMS37	10250TS37	10250TL37	—	—	—	—	—
	Green/red	—	—	—	—	—	—	10250TPP20	10250TPP21
	Satin alum.	—	—	—	10250TNP99	—	—	—	—
1/2 Round	Black	10250TP36	10250TM36	10250TJ36	—	—	10250TM72	10250TR17	10250TR18
	Red	10250TP37	10250TM37	10250TJ37	—	—	—	—	—
	Green/red	—	—	—	—	—	—	10250TR20	10250TR21
	Satin alum.	—	10250TM89	10250TJ89	—	—	—	—	—

Notes

- ① Cannot be used on cast enclosures except for top row. Suitable for most sheet metal enclosures.
- ② When used to meet Ford Motor Co. specifications, specify engraved legend. Cannot be used on standard cast or sheet metal enclosures.
- ③ Slightly larger than standard size for legends requiring more space—fits cast enclosures.
- ④ All push-pull legend plates include the symbols ≠ ∅ in the center of the plate.
- ⑤ Square legend plates have a satin aluminum field. Color is on lower portion.

Accessories

Accessories









	Description	Catalog Number
Padlock Attachments		
	Padlocking Attachment for Flush Pushbutton Operators Permits locking NC contacts in open position with 1/4 in padlock. Will not lock NO contact.	10250TA2
	Padlocking Attachment for Use with Extended Pushbutton Permits locking NC contacts in open position with 1/4 in padlock.	10250TA26
	Padlocking Cover Guard Cover locked over flush button makes it inaccessible or on extended button locks NC contacts open. Takes 1/4 in shank size padlock.	10250TA36
	Padlock Hasp or Flip-Up Guard When used with a 1/4 in padlock, makes flush and long button and knob selector switch inaccessible, but not locked down. Without the padlock, it is a flip-up guard. Padlock hasp can be removed before assembly.	10250TA38
	Padlocking Attachment for Use with Flexible Weather Resistant Boot Used on long button operators. Stainless steel. Use only for locking NC contacts open.	10250TA63
	Padlock Attachment For use with illuminated pushbuttons and maintained push-pull operators having standard button or lens only. Use 1/4 in padlock. Locks in down position only.	10250TA64
	Padlocking Attachment for Non-Illuminated Knob Selector Switches Provision for up to 5, 1/4 in padlocks.	10250TA11
Shrouds and Guards		
	Shroud for Mushroom Head Operator Prevents accidental operation. (Not for push-pull operators.)	10250TA6
	Extended Retaining Nut Replaces standard nut and provides guard for flush head pushbutton operators.	10250TA12
	Guard for Illuminated Pushbutton	10250TA15
	Shroud For jumbo mushroom head operator. Gray	10250TA56
	Yellow	10250TA56Y
	Half Shroud—Yellow For jumbo mushroom head operator.	10250ED1241
	Fingerproof Shroud 10 per package Fits new style contact blocks and light units.	10250TA101











	Description	Catalog Number
Boots		
	Flexible Weather Resistant Boot For use with button operators (extended buttons preferred). Temperature to -25°F (-32°C). (See Page V9-T4-48 for 10250TA96 Tightening Tool.) Black	10250TA3
	Red	10250TA4 ①
	Green	10250TA10
	Transparent Boot For regular illuminated pushbutton operators and PresTest—Temperature to -38°F (-39°C). ②	10250TA25
	Boot for Flush Pushbutton Clear	10250TA46
	Black	10250TA47
	Red	10250TA48
	Green	10250TA49
Hardware and Kits		
	Thrust Washers To meet Ford Motor Co. mounting specifications.	10250TK3
	Contact Block Tape Seal Seals plunger openings on last contact block. Order in multiples of 10 pieces.	10250TK5
	Selector Switch Operator Gasket Seals out dust from getting in between the cam and contact block plungers. Supplied as standard with all selector switches.	56-9337
	Special Retaining Nut To accommodate thick panel: Indicating lights	10250TA30
	PresTest, pushbuttons and selector switches	10250TA31
	Terminal Block Two terminals, each will accommodate two wire terminations.	10250TA62
	Spacer Ring Used when legend plate is not required.	10250TA8
	Stacking Screw Replaces transformer mounting screws on indicating light so terminal block 10250TA62 can be mounted to light to support and connect a series resistor. This screw also fits all contact blocks. Order in multiples of 10.	10250TA79

Notes

- ① Should not be used on flush button for STOP function.
- ② Not suitable for single contact block depth cast enclosure. Cover is too thick.

Accessories, continued

Description	Catalog Number
Hardware and Kits, continued	
10250TA2_ 	Base Mounting Spacers ① Equivalent to contact block in depth—complete with screws, washers, etc. 1 block deep 10250TA22 2 block deep 10250TA23
10250TKG_ 	Grounding Kits Kits consist of a ring connector and a #6 screw for mounting connector to rear of contact block mounting screw. All components except standard indicating lights and PresTest indicating lights. 10250TKG1 Standard indicating lights 10250TKG2 ② PresTest indicating lights 10250TKG3 ②
10250TA7_ 	Contact Block Terminal Jumpers Available in multiples of 100 only. Terminal to terminal—within block (short) 100 per pkg. 10250TA70 1000 per pkg. 10250TA70-2 Terminal to terminal—block to block (long) 100 per pkg. 10250TA71 1000 per pkg. 10250TA71-2
Special Operators and Attachments	
10250TA5 	Wobble Stick 10250TA5 Complete with retaining nut—fits standard button.
10250TA14 	Lever Operator 10250TA14 For use with two vertically mounted flush pushbuttons.
10250TA_ 	Maintained Contact Attachment Release Button Assembly ① Mechanically interlocks with another pushbutton and contact block (not included). Provides mode indication. Minimum hole centers 1.62 in (41.1 mm), maximum 2.31 in (58.8 mm). Black 10250TA17 Red 10250TA18 Green 10250TA19 Yellow 10250TA20 Same with long button—black 10250TA39
10250TA1 	Maintained Contact Attachment ① 10250TA1 Mechanically interlocks two buttons and provides position indication for one. Use with two pushbutton operators and one or more contact blocks.
10250TA13 	Roto-Push Lever Operator 10250TA13 Used to provide lever operation for Roto-Push operators.

Description	Catalog Number
Special Light Modules	
10250TA79 	Master Test (Dual Input) Module Internal Form C relay suitable for either AC or DC applications. Total electrical isolation between monitored and test circuit. Fits all illuminated 10250T, E22, E30 and E34 devices. 48 Vdc 10250TMT8
10250TFL_ 	Flasher Module Changes any AC illuminated device to a controlled flashing light. Fits 10250T, E30 and E34 devices. 24V 10250TFL2 120V 10250TFL1
10250ED986-4 	Flashing Incandescent Lamp 10250ED986-4 For use with 120V transformer type or 6V full voltage type indicating lights including PresTest and most E29 devices.
Hole Plugs	
10250TA7 	Plug 10250TA7 For unused holes—steel, painted gray (stainless steel, use E30KT5)
Tools	
10250TA95 	Octagonal 10250T (notched to fit over selector switch lever), E29 and E30 10250TA95
E22CW 	E22, E30, E34 and octagonal 10250T (will not fit over selector switch levers) E22CW
10250TA96 	Tool for Tightening Boots 10250TA96 Used to install boot Catalog Numbers 10250TA3, A4, A10 and A25.
10250TA102 	10250T, E34 Allen Wrench 10250TA102 Used for removal of jumbo mushroom head.
10250TA74 	Lamp Removal Tools 10250TA74 For transformer type illuminated pushbuttons, push-pull and selector switches. Fits #12 lamp.
E30KV1 	For full voltage and resistor type illuminated pushbuttons, push-pull and selector switches and E30. E30KV1
E29KLT 	Standard indicating lights. Fits #44, #755, #6S6 and #10S6. E29KLT

Notes

- ① Component only. Not to be used for custom built (factory assembled) stations.
- ② Not suitable for single contact block depth cast enclosure. Cover is too thick.

Product Overview

Product Selection Guide



Description	E26
	Page V9-T4-50
Standards and Certifications	
	CE 60947-5-1 UL 508—File #E131568 cUL C22.2 No. 14—File #E131568
Ingress protection	Stacklight base and light units: IP65, Type 4, 4X and 13 Alarm units: IP20, Type 1
Electrical shock protection	Stacklight base and light unit: IP2X Alarm units: IPOX
Technical Data and Specifications	
Mechanical ratings	Shock (IEC 68-2-27): 11 ms, 15g Vibration (IEC 68-2-6): 10 sweeps 10–150 Hz, 2g Bump (IEC 68-2-29): 1000 pulses, 6 ms, 15g
Climate conditions	Operating: maximum 104°F (40°C) at 95% RH, Temperature –4° to 140°F (–20° to 60°C) Storage: temperature –40° to 176°F (–40° to 80°C)
Materials	Cover: polycarbonate Lenses: polycarbonate Stacklight base: nylon Extension tubes: aluminum Mounting base: zinc die cast
Terminals	14–30 AWG (2.5–0.05 mm ²) for single conductors and 18–26 AWG (0.75–0.14 mm ²) for two conductors of the same size. Do not mix solid and stranded wire in the same terminal. Recommended tightening torque is 4.4–5.3 lb-in (0.5–0.6 Nm)
Electrical ratings	Insulation voltage (U _i): 690V Operational voltage (U _o): 250V Impulse withstand voltage (U _{imp}): 1.5 kV
Bulb specifications	Incandescent lamp type: BA15d Maximum lamp wattage: 6W Bulbs—average life: Incandescent: 7,000–12,000 hrs. (based on voltage) Xenon flasher: 20,000 hrs. LED: 60,000–100,000 hrs. (based on colors)
LED/Incandescent comparison	Incandescent lamps Average operating life of 7,000 hours Each lamp can be used with any color lens Low cost results in short-term savings LED lamps Average operating life of 60,000–100,000 hours Low power consumption Extended life results in long-term savings

For our complete product offering, see Volume 7—Logic Control, Operator Interface and Connectivity Solutions, CA08100008E.

E26 Stacklights



4

Features

- Modular construction
- Six lens colors
- Variety of lamp types and voltages
- Mono-tonal, bi-tonal and intermittent audible alarms
- Combination of visible and audible alarms
- Modular components reduce inventory requirements, increase flexibility
- Steady and flashing modes allow one light to signal multiple conditions
- No-tools assembly permits easy lamp replacement

One, two and three-Light assembled stacklights:

- Base mountable
- Incandescent or LED versions
- 24V and 120V versions

Catalog Number Selection

E26 Stacklights

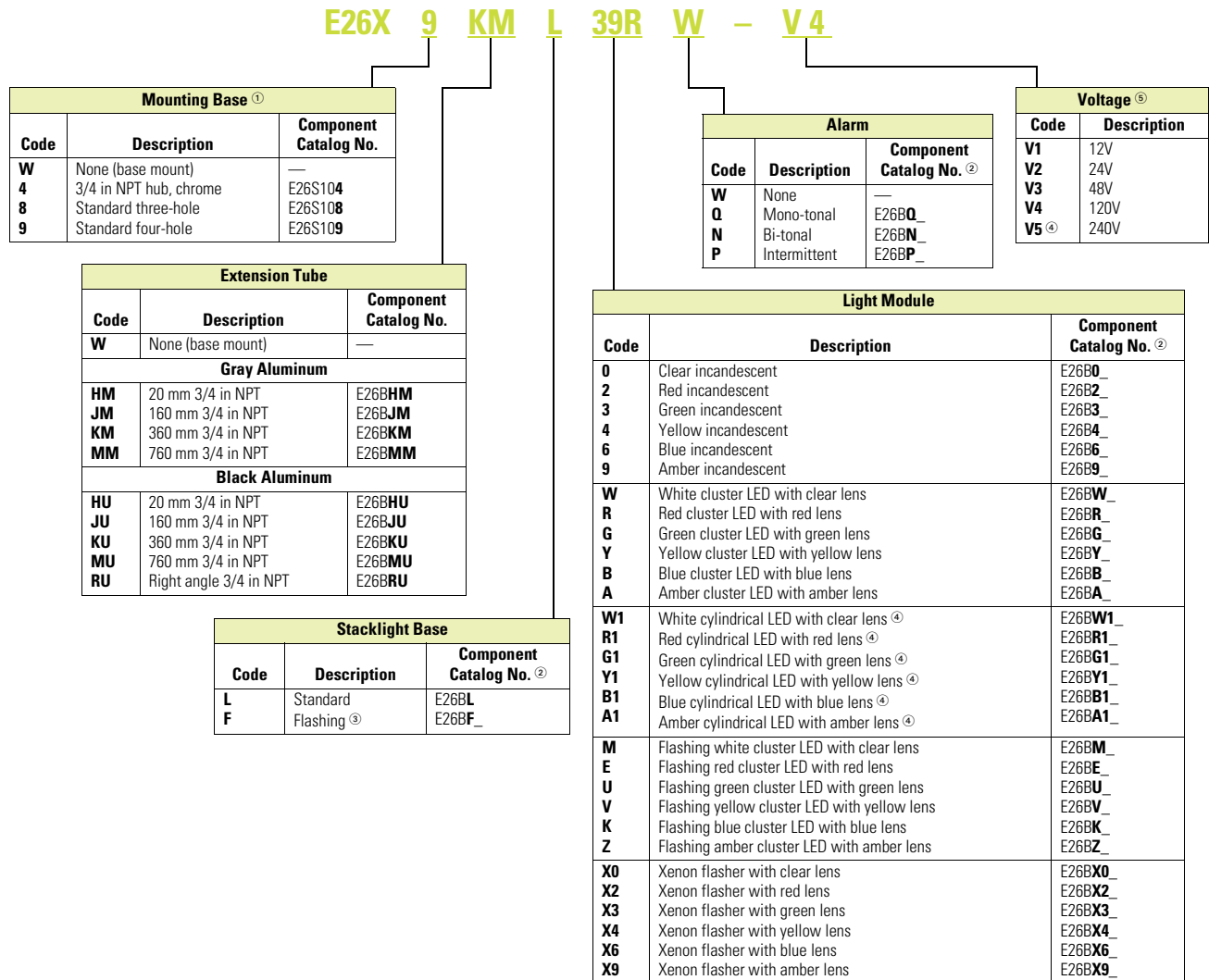

Voltage Codes

Voltage Code	Incandescent Lamp	Cluster LED	Cylindrical LED	Xenon Flasher	Flasher Base/Alarm
(Blank)	No lamp supplied	No LED supplied	No LED supplied	—	—
V1	12 Vac/Vdc	12 Vac/Vdc	12 Vac/Vdc	12 Vac/Vdc	12 Vac/Vdc
V2	24 Vac/Vdc	24 Vac/Vdc	24 Vac/Vdc	24 Vac/Vdc	24 Vac/Vdc
V3	48 Vac/Vdc	48 Vac/Vdc	48 Vac/Vdc	48 Vac/Vdc	48 Vac/Vdc
V4	120 Vac/Vdc	120 Vac	120 Vac	120 Vac	120 Vac/Vdc
V5	240 Vac/Vdc	240 Vac	—	240 Vac	240 Vac/Vdc

Notes

- ① Unless base mount is specified, an extension tube must be selected for a complete unit.
- ② Component catalog numbers for flashing bases, alarm units and light modules are incomplete and require the addition of a suffix code to specify the required voltage rating. See table above.
- ③ Flashing base is for use with incandescent lamps.
- ④ 240V not available for cylindrical LEDs.
- ⑤ If no voltage is specified, assembled stacklight will be supplied without lamps or LEDs.

Product Selection

Assembled Units

One-Light Unit Stacklight

Volts AC/DC	Alarm	First Level Color	Illumination Type	Catalog Number
24V	None	Red	Incandescent—steady	E26XWWL2W-V2
24V	None	Red	Cylindrical LED—steady	E26XWWL1W-V2
24V	None	Green	Incandescent—steady	E26XWWL3W-V2
24V	None	Green	Cylindrical LED—steady	E26XWWL1W-V2
24V	None	Amber	Incandescent—steady	E26XWWL9W-V2
24V	None	Amber	Cylindrical LED—steady	E26XWWL1W-V2
120V	None	Red	Incandescent—steady	E26XWWL2W-V4
120V ^①	None	Red	Cylindrical LED—steady	E26XWWL1W-V4
120V	None	Green	Incandescent—steady	E26XWWL3W-V4
120V ^①	None	Green	Cylindrical LED—steady	E26XWWL1W-V4
120V	None	Amber	Incandescent—steady	E26XWWL9W-V4
120V ^①	None	Amber	Cylindrical LED—steady	E26XWWL1W-V4

Two-Light Unit Stacklight

Volts AC/DC	Alarm	First Level Color	Illumination Type	Second Level Color	Illumination Type	Catalog Number
24V	None	Green	Incandescent—steady	Red	Incandescent—steady	E26XWWL32W-V2
24V	None	Green	Cylindrical LED—steady	Red	Cylindrical LED—steady	E26XWWL1R1W-V2
120V	None	Green	Incandescent—steady	Red	Incandescent—steady	E26XWWL32W-V4
120V ^①	None	Green	Cylindrical LED—steady	Red	Cylindrical LED—steady	E26XWWL1R1W-V4

Three-Light Unit Stacklight

Volts AC/DC	Alarm	First Level Color	Illumination Type	Second Level Color	Illumination Type	Third Level Color	Illumination Type	Catalog Number
24V	None	Green	Incandescent—steady	Amber	Incandescent—steady	Red	Incandescent—steady	E26XWWL392W-V2
24V	None	Green	Cylindrical LED—steady	Amber	Cylindrical LED—steady	Red	Cylindrical LED—steady	E26XWWL1A1R1W-V2
120V	None	Green	Incandescent—steady	Amber	Incandescent—steady	Red	Incandescent—steady	E26XWWL392W-V4
120V ^①	None	Green	Cylindrical LED—steady	Amber	Cylindrical LED—steady	Red	Cylindrical LED—steady	E26XWWL1A1R1W-V4

Note

^① LED modules have very low current draw and should not be used with triac output devices like PLC triac output modules. It is recommended that dry contact outputs be used to switch 120 Vac modules.

Replacement Parts

Stacklight Replacement Parts

Description	Notes	Diagram	Catalog Number
Replacement cover	Normally included with stacklight base	1	E26S68
Replacement lens O-ring	Normally included with light modules	2	E26S106 ①
Replacement lenses	Clear	3	E26S38
	Red		E26S39
	Green		E26S40
	Yellow		E26S41
	Blue		E26S42
	Amber		E26S43
Replacement Xenon strobe dual high (does not include lenses)	12 Vac/Vdc	4	E26S33
	24 Vac/Vdc		E26S34
	48 Vac/Vdc		E26S35
	120 Vac		E26S36
	240 Vac		E26S37
Replacement diffusers	White—normally supplied with incandescent light modules	4	E26S31
	Clear—normally supplied with LED light modules		E26S32
Replacement lamps	12V	5	E26S8
	24V		E26S9
	48V		E26S10
	120V		E26S11
	240V		E26S12
Replacement extension tube O-rings	Normally included with extension tubes	6	E26S107 ②
Replacement mounting gasket ③	Normally included with stacklight base	7	E26S105
Lamp removal tool	For E26 and E22 incandescent lamps		E22BA3

Typical Stacklight Assemblies

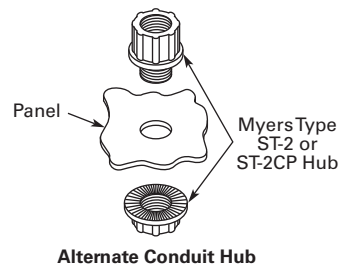
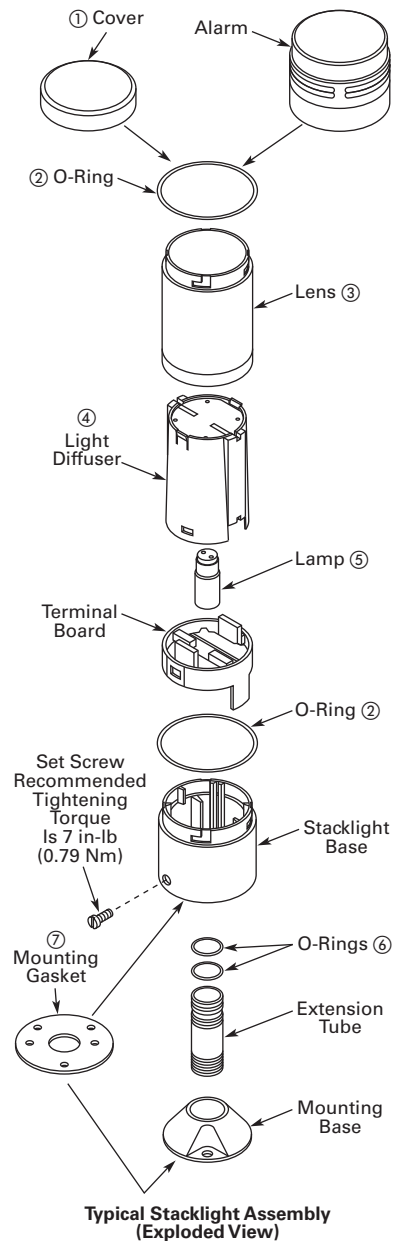

Notes

- ① Sold in packages of 5 pieces.
- ② Sold in packages of 10 pieces.
- ③ Mounting gaskets have two sets of mounting holes—one set with center-to-center spacing of 1.75 in (44.5 mm) and another set with center-to-center spacing of 1.65 in (42 mm).

Product Overview

Product Selection Guide



E5 Panel Meters



Eclipse Series Panel Meters

Description	E5 Panel Meters Page V9-T4-55	Eclipse Series Panel Meters Page V9-T4-55
Number of digits	5	4
Display technology	7-segment LED	7-segment LED
Display character height	8 mm	14 mm
Panel cut-out size	1/32 DIN (25 x 50 mm)	1/8 DIN (45 x 92 mm)
Available outputs	None	Dual relay, analog, RS-485
Available inputs	0–10V/2–10V/0–20 mA/4–20 mA	DC volt, AC volt, DC amp, AC amp, 5A AC, Temperature (J, K, T, PT100 RTD), 4–20 mA/0–10V/1–5V
Front panel protection	IP65	NEMA 4X
Connection method	Screw terminal	Depluggable screw terminals
Scaling	Programmable end points, linear interpolation	Programmable end points, linear interpolation
Input power options	10–30 Vdc	9–30 Vdc or 85–264 Vac
Update time	500 ms	400 ms
Automatic min/max capture	Yes	Yes
Input for display-hold	Yes	—

For our complete product offering, see Volume 7—Logic Control, Operator Interface and Connectivity Solutions, CA08100008E.

Digital Panel Meters



Features

E5-324-E digital panel meters

- Galvanic isolation with protection against incorrect polarity
- Automatic min/max value detection
- Freely programmable characteristic curve end points
- Input range:
 - Single current measuring input (0/4–20 mA)
 - Single voltage measuring input (0/2–10V)

Eclipse Series digital panel meters

- Four full digits
- 1/8 DIN size
- Red, LED display
- Scalable display
- Flashing alarms
- Min/max data hold
- Optional analog, relay and RS-485 outputs
- Type 4X

Catalog Number Selection

Digital Panel Meters

Eclipse Series

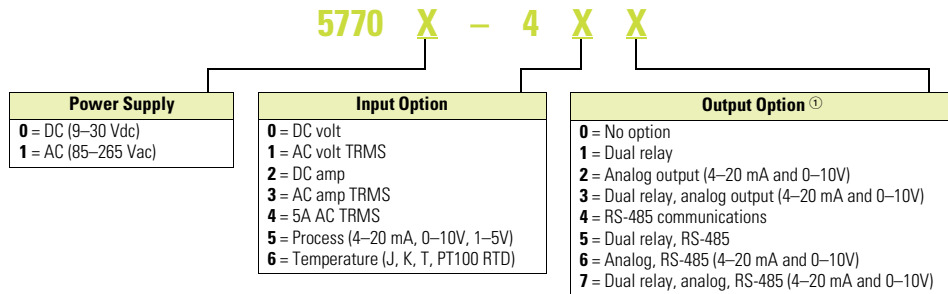

Product Selection

E5-324-E0402



E5-324-E0402

Description	Catalog Number
LED digital panel meter, 24 x 48 mm	E5-324-E0402

Eclipse Series



Eclipse Series

Description	Catalog Number
Digital ammeter—5A AC, 85–264 Vac power	57701440
Digital ammeter—5A AC, 85–264 Vac power, 2 relay outputs	57701441
Digital process meter—4–20 mA/0–10V, 85–264 Vac power	57701450
Digital process meter—4–20 mA/0–10V, 85–264 Vac power, 2 relay outputs	57701451
Digital process meter—4–20 mA/0–10V, 85–264 Vac power, 2 relay outputs and analog retransmission	57701453
Digital temperature meter, 85–264 Vac power	57701460
Digital temperature meter, 85–264 Vac power, 2 relay outputs	57701461

Note

① Output options 0, 2, 4 are not available for models -41X and -43X.

Product Overview

Operator Interfaces and Programming Software Selection Guide



4

Description	ELC-GP Graphics Panel	HM/I Operator Interface
	Page V9-T4-59	Page V9-T4-60
Screen size	Two-line and four-line	3.5 in, 5.7 in, 8.0 in and 10.4 in
Screen options	Monochrome	Blue mode, grey scale, 256 color STN or 65k color TFT
Interface	Keypad only	Resistive touchscreen only or touchscreen and keypad
Communication ports	2 serial	3 serial; 1 or 2 USB; Expansion port for Ethernet Modbus TCP or Local I/O
Simultaneous protocols	1	3 or 4
Ethernet drivers	—	Yes
Upload/download	Serial cable	Serial, Ethernet, and/or USB
Operating system	Proprietary	Proprietary
Third-party software support	—	—
Screen saver	—	Yes

Operator Interfaces and Programming Software Selection Guide, continued



Description	XV Operator Interface	XP Operator Interface
	Page V9-T4-62	Page V9-T4-65
Screen size	3.5 in, 5.7 in, 7.0 in, 8.4 in and 10.4 in	8.4 in, 10.4 in, 12.1 in, 15.0 in and blind node (no screen)
Screen options	Color TFT, 64k colors; resolutions from QVGA (320 x 240) to WVGA (800 x 480)	Color TFT, 16 million colors; resolutions from SVGA (800 x 600) to UVGA (1600 x 1200)
Interface	Resistive touchscreen	Infrared, non-reflective safety glass
Communication ports	Ethernet, RS-232 and/or RS-485, USB	2 serial; 2 Ethernet; removable CompactFlash; 4 USB; VGA
Simultaneous protocols	3	5 or 8
Ethernet drivers	Yes	Yes
Upload/download	Serial, Ethernet, USB	Serial, Ethernet, USB
Operating system	Windows CE 5.0 Professional	Windows XP Embedded (protected)
Third-party software support	—	Yes
Screen saver	Yes	Yes

For our complete product offering, see Volume 7—Logic Control, Operator Interface and Connectivity Solutions, CA08100008E.

Software Product Selection Guide



Description	Visual Designer	Galileo	HMIsoft	ELCSoftGP
Overview	Feature-rich software package with SCADA functionality and web serving capabilities that can be run on XV, XP, ePro PS operator interfaces or personal computers	Intuitive visualization tool. Use Galileo on XV-102-H_ units or on XV units running CoDeSys when a stronger visualization package is needed	Use HMIsoft to create, edit, upload and download applications to the HMI family of operator interfaces	Use ELCSoftGP to create, edit, upload and download applications to ELC Graphics Panels
Catalog ID				
Development software seat license	VISUALDCE (CE hardware) VISUALDXP5 (5-pack of VISUALDXP) VISUALDCE5 (5-pack of VISUALDCE) VISUALDXP (PCs, XPe, and CE hardware)	SW-GALILEO-S SW-GALILEO-M	HMISOFT	ELCSOFTGP
Runtime software for a PC	VISUALRTPC	•	N/A	N/A
Time-Saving Editor Features				
Online and offline simulation	•	•	•	—
Macro capability	•	•	•	—
VB scripting	•	—	—	—
Math and Logic	•	•	•	—
Multi-language	•	•	•	—
System/internal variables	•	•	•	—
Auto-scale application to different resolution/screen size	•	•	•	—
Scripting (IF, THEN, ELSE, GOTO)	•	•	•	—
Symbol factory/library	•	•	•	—
Master pages	• Screen groups	• Screen groups	•	—
User-created controls	•	•	—	—
Customizable application symbols	•	•	—	—
Action lists/math worksheets	•	• With macros	• With macros	—
Reusable controls, images and pages	• Via indirect tag and/or PLC assignments	•	—	—
Advanced search and replace	•	•	—	—
Advanced context sensitive help	•	•	—	—
Conversion of legacy PanelMate™ configurations	•	—	—	—
Optional PanelBuilder™ conversion utility	•	—	—	—
Online configuration/editing	•	—	—	—

Software Product Selection Guide, continued



4

Description	Visual Designer	Galileo	HMSoft	ELCSoftGP
Runtime Features				
Clock synchronization	•	•	•	•
Sound actions or control	•	•	•	•
Security	• Advanced multi-level	•	• Multi-level	•
Pop-up screens	• And group screens	•	•	—
Animated graphics	•	•	•	—
Real-time trending	•	•	•	—
Recipes	•	•	•	—
Report generation	•	•	—	—
Timer scheduling	•	•	•	—
Calendar scheduling	•	—	—	—
Notification of data and events via e-mail/text messaging	•	—	—	—
Data archiving	•	•	•	—
Archive to shared network drive	•	No (-)	—	—
Alarm and event archiving	•	•	—	—
Historical trending	•	•	•	—
Import/export from XML	•	•	—	—
Database interface	• ADO.net compliant	—	—	—
Vision system interfaces	•	•	—	—
Secure document and Web network browser	•	—	—	—
Remote access and control without having to install software on the remote PC	• Web Thin Client with Internet Explorer	—	—	—
Automatic scaling of Web clients	•	—	—	—
Remote desktop	• With UltraVNC and RemoteClient	• VNC and RemoteClient	—	—
Launch/control third-party applications	•	—	—	—
2-touch controls for safety	•	—	—	—
Embedded PLC logic	—	—	•	—

ELC-GP Graphics Panel



Features

- Simple to program and easily connects to ELC products
- Protocols—include Modbus ASCII/RTU, ASCII Slave and vendor-specific protocols from Allen-Bradley®, Siemens®, Mitsubishi®, Koyo® and many more

Catalog Number Selection

ELC-GP Graphics Panel

ELC-GP

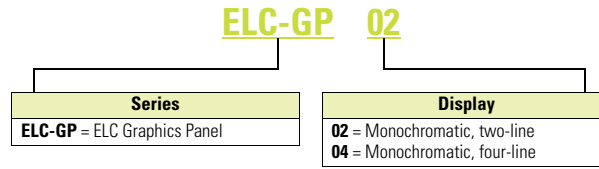

Product Selection

Graphics Panels

Description	Catalog Number
160 x 32 pixels, 10 function keys, monochrome	ELC-GP02
128 x 64 pixels, 10 function keys, monochrome	ELC-GP04

Accessories

Software and Accessories

Description	Catalog Number
Programming software for GP units	ELCSOFTGP
Program transfer module	ELC-GPXFERMOD
Cable, PC to ELC-GPxx, 9.8 ft (3m)	ELC-CBPCGP3
Power supply, 24 watt, 1 amp	ELC-PS01
Power supply, 48 watt, 2 amp	ELC-PS02

4.4

Operator Interface

Operator Interfaces and Programming Software

4

HMI Operator Interface



Features

- All units offer RS-232, RS-485 and RS-422 communications
- 6-, 8- and 10-inch models offer Ethernet communication options
- Retentive internal data storage

Catalog Number Selection

HMI Operator Interface

HMI

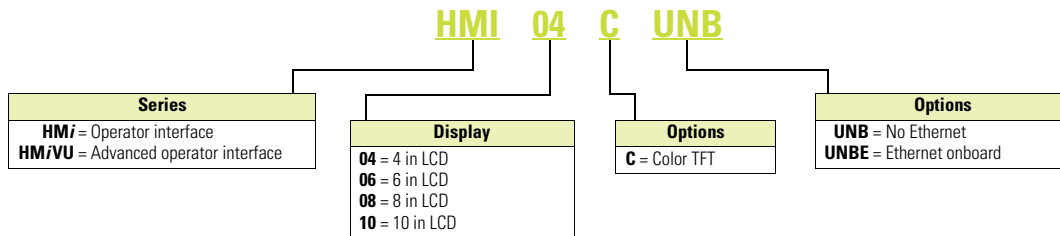

Product Selection

HMI Operator Interface

Description	Catalog Number
4-inch color TFT without expansion slot	HMI04CU
6-inch color TFT, no Ethernet	HMIVU06CUNB
8-inch color TFT, with Ethernet	HMIVU08CUNBE
10-inch color TFT, with Ethernet	HMIVU10CUNBE

Accessories

Software and Accessories

Description	Catalog Number
Programming software	HMISOFT

Kits

Description	Catalog Number
HMI spare parts kits (includes several power connectors, battery doors, gaskets, mounting clips, etc.)	HMI-SPKIT

Cable

Description	Catalog Number
1 meter cable to connect between the HMI and Eaton Logic Controller (ELC)	ELC-CBPCELC1
3 meter cable to connect between the HMI and Eaton Logic Controller (ELC)	ELC-CBPCELC3

Power Supply

Description	Catalog Number
1 amp 24 Vdc power supply	ELC-PS01
2 amp 24 Vdc power supply	ELC-PS02

XV Operator Interface



Features

- All XV models have a Microsoft Windows CE operating system
- Pre-licensed with Visual Designer runtime for up to 1500 tags, three simultaneous communication drivers, and one Web session
- Field upgrades are available for up to 4000 tags, three drivers, and two, four or eight simultaneous Web sessions

Catalog Number Selection

XV Operator Interface

XV

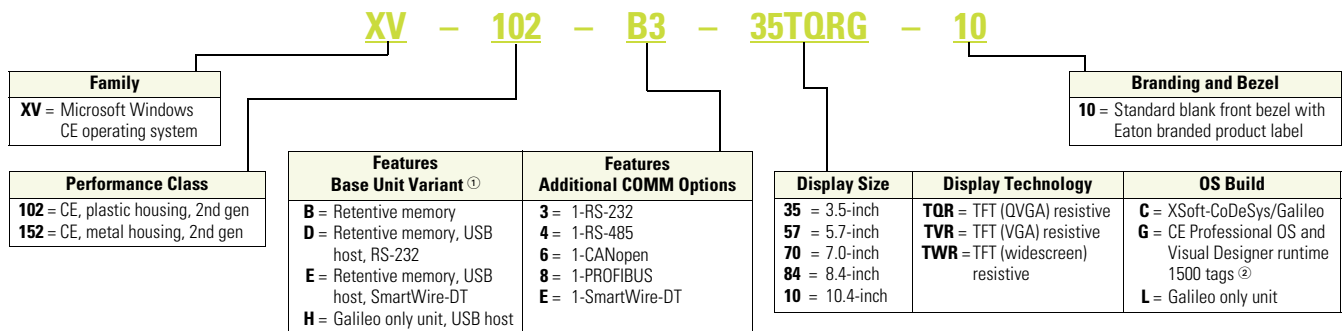

Product Selection

XV Operator Interface



XV Operator Interface with Visual Designer

Description	Catalog Number
XV 3.5-inch TFT, plastic housing, resistive touch, Ethernet and RS-232	XV-102-B3-35TQRG-10
XV 3.5-inch TFT, plastic housing, resistive touch, Ethernet and RS-485	XV-102-B4-35TQRG-10
XV 5.7-inch TFT, plastic housing, resistive touch, Ethernet, RS-232, RS-485	XV-102-D4-57TVRG-10
XV 7.0-inch TFT wide screen, plastic housing, resistive touch, Ethernet, RS-232, RS-485	XV-102-D4-70TWVRG-10
XV 5.7-inch TFT, metal housing, resistive touch, Ethernet, RS-232, RS-485	XV-152-D4-57TVRG-10
XV 8.4-inch TFT, metal housing, resistive touch, Ethernet, RS-232, RS-485	XV-152-D4-84TVRG-10
XV 10.4-inch TFT, metal housing, resistive touch, Ethernet, RS-232, RS-485	XV-152-D4-10TVRG-10

Notes

- ① All 1xx performance class units have 400 MHz processor, 64 MB DRAM, 1 x 10/100 Ethernet, and 1 x USB device.
- ② Standard software on embedded hardware. These XV models have a Microsoft Windows CE 5.0 Professional operating system and are pre-licensed with Visual Designer runtime for up to 1500 tags, 3 simultaneous communication drivers, and 1 Web session. Field upgrades are available for up to 4000 tags, 3 drivers, and 2, 4 or 8 simultaneous Web sessions.

XV Operator Interface with XSoft-CoDeSys

Description	Catalog Number
XV 3.5-inch TFT plastic housing, resistive touch, CANopen	XV-102-B6-35TQRC-10
XV 3.5-inch TFT plastic housing, resistive touch, PROFIBUS	XV-102-B8-35TQRC-10
XV 3.5-inch TFT plastic housing, resistive touch, SmartWire-DT	XV-102-BE-35TQRC-10
XV 5.7-inch TFT plastic housing, resistive touch, CANopen	XV-102-D6-57TVRC-10
XV 5.7-inch TFT plastic housing, resistive touch, PROFIBUS	XV-102-D8-57TVRC-10
XV 5.7-inch TFT plastic housing, resistive touch, CANopen, SmartWire-DT	XV-102-E6-57TVRC-10
XV 5.7-inch TFT plastic housing, resistive touch, PROFIBUS, SmartWire-DT	XV-102-E8-57TVRC-10
XV 7.0-inch TFT plastic housing, resistive touch, CANopen	XV-102-D6-70TWRC-10
XV 7.0-inch TFT plastic housing, resistive touch, PROFIBUS	XV-102-D8-70TWRC-10
XV 7.0-inch TFT plastic housing, resistive touch, CANopen, SmartWire-DT	XV-102-E6-70TWRC-10
XV 7.0-inch TFT plastic housing, resistive touch, PROFIBUS, SmartWire-DT	XV-102-E8-70TWRC-10
XV 5.7-inch TFT metal housing, resistive touch, CANopen	XV-152-D6-57TVRC-10
XV 5.7-inch TFT metal housing, resistive touch, PROFIBUS	XV-152-D8-57TVRC-10
XV 5.7-inch TFT metal housing, resistive touch, CANopen, SmartWire-DT	XV-152-E6-57TVRC-10
XV 5.7-inch TFT metal housing, resistive touch, PROFIBUS, SmartWire-DT	XV-152-E8-57TVRC-10
XV 8.4-inch TFT metal housing, resistive touch, CANopen	XV-152-D6-84TVRC-10
XV 8.4-inch TFT metal housing, resistive touch, PROFIBUS	XV-152-D8-84TVRC-10
XV 8.4-inch TFT metal housing, resistive touch, CANopen, SmartWire-DT	XV-152-E6-84TVRC-10
XV 8.4-inch TFT metal housing, resistive touch, PROFIBUS, SmartWire-DT	XV-152-E8-84TVRC-10
XV 10.4-inch TFT metal housing, resistive touch, CANopen	XV-152-D6-10TVRC-10
XV 10.4-inch TFT metal housing, resistive touch, PROFIBUS	XV-152-D8-10TVRC-10
XV 10.4-inch TFT metal housing, resistive touch, CANopen, SmartWire-DT	XV-152-E6-10TVRC-10
XV 10.4-inch TFT metal housing, resistive touch, PROFIBUS, SmartWire-DT	XV-152-E8-10TVRC-10

XV Operator Interface with Galileo Only

Description	Catalog Number
XV 3.5-inch TFT plastic housing, resistive touch, Ethernet RS-232	XV-102-H3-35TQRL-10
XV 3.5-inch TFT plastic housing, resistive touch, Ethernet RS-485	XV-102-H4-35TQRL-10
XV 5.7-inch TFT plastic housing, resistive touch, Ethernet RS-232	XV-102-H3-57TVRL-10
XV 5.7-inch TFT plastic housing, resistive touch, Ethernet RS-485	XV-102-H4-57TVRL-10
XV 7.0-inch TFT plastic housing, resistive touch, Ethernet RS-232	XV-102-H3-70TWRL-10
XV 7.0-inch TFT plastic housing, resistive touch, Ethernet RS-485	XV-102-H4-70TWRL-10

Visual Designer**Visual Designer Software**

Description	Catalog Number
Visual Designer Development Software License Key	
For CE hardware	VISUALDCE
For PCs, XPe and CE hardware	VISUALDXP
For CE hardware, 5-pack of VISUALDCE	VISUALDCE5
For PCs, XPe hardware, 5-pack of VISUALDXP	VISUALDXP5

4

Galileo Software**Galileo Development Software**

Description	Catalog Number
Single-seat license	SW-GALILEO-S
Multiple-seat license	SW-GALILEO-M

XSoft-CoDeSys-2**XSoft-CoDeSys-2 Software**

Description	Catalog Number
Single Seat License	SW-XSOFT-CODESYS-2-S
Multiple Seat License (3)	SW-XSOFT-CODESYS-2-M

Accessories**XV Family Accessories**

Description	Catalog Number
SD memory card for all XV models	MEMORY-SD-A1-S
Spare part kit for XV-102 models—1 power connector, 8 mounting brackets, 1 sealing strip, 1 touch pen	ACC-TP-57-KG-1 XV-102
Spare part kit for XV-152 models—1 power connector, 8 mounting brackets, 1 sealing strip, 1 touch pen	ACC-TP-10-12-RES-1

XP Operator Interface



Features

- All XP models have a Microsoft Windows XP embedded operating system
- Pre-licensed with Visual Designer runtime
- Standard models are licensed for 4000 tags, five simultaneous communication drivers, and one Web session
- Enterprise models are licensed for 64,000 tags, eight simultaneous communication drivers, and one Web session
- Field upgrades are available for up to 64,000 tags, eight drivers, and 2, 4, 8, 16, 32, 64, 128, or 256 simultaneous Web sessions

Catalog Number Selection

XP Operator Interface

XP

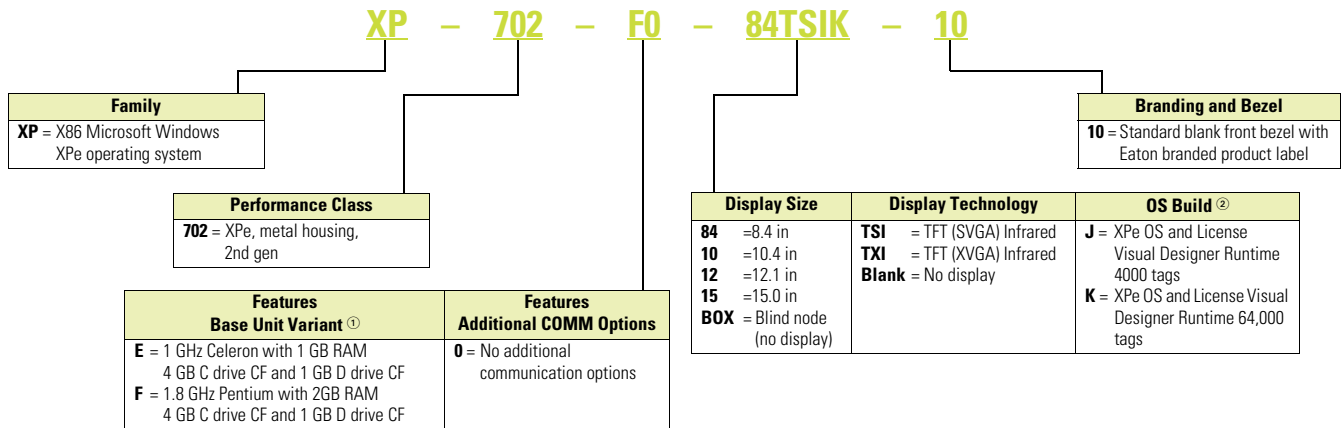

Notes

- ① All 7xx Performance Class units have 1 x 10/100, 1 x 10/100/1000 Ethernet, 4 x USB Host V2.0, 2 x RS-232.
- ② Standard software on embedded hardware.

Product Selection

XP Operator Interface

XP Operator Interface



Description	Catalog Number
XP 8.4 in TFT, 1 GHz Celeron, 1 GB RAM, 4 GB C drive, 1 GB D drive, 4000 tags, 5 drivers, 1 Web session	XP-702-E0-84TSIJ-10
XP 10.4 in TFT, 1 GHz Celeron, 1 GB RAM, 4 GB C drive, 1 GB D drive, 4000 tags, 5 drivers, 1 Web session	XP-702-E0-10TSIJ-10
XP 12.1 in TFT, 1 GHz Celeron, 1 GB RAM, 4 GB C drive, 1 GB D drive, 4000 tags, 5 drivers, 1 Web session	XP-702-E0-12TXIJ-10
XP 15.0 in TFT, 1 GHz Celeron, 1 GB RAM, 4 GB C drive, 1 GB D drive, 4000 tags, 5 drivers, 1 Web session	XP-702-E0-15TXIJ-10
XP blind node (no display), 1 GHz Celeron, 1 GB RAM, 4 GB C drive, 1 GB D drive, 4000 tags, 5 drivers, 1 Web session	XP-702-E0-BOXJ-10
XP 8.4 in TFT, 1.8 GHz Pentium, 2 GB RAM, 4 GB C drive, 1 GB D drive, 64k tags, 8 drivers, 1 Web session	XP-702-F0-84TSIK-10
XP 10.4 in TFT, 1.8 GHz Pentium, 2 GB RAM, 4 GB C drive, 1 GB D drive, 64k tags, 8 drivers, 1 Web session	XP-702-F0-10TSIK-10
XP 12.1 in TFT, 1.8 GHz Pentium, 2 GB RAM, 4 GB C drive, 1 GB D drive, 64k tags, 8 drivers, 1 Web session	XP-702-F0-12TXIK-10
XP 15.0 in TFT, 1.8 GHz Pentium, 2 GB RAM, 4 GB C drive, 1 GB D drive, 64k tags, 8 drivers, 1 Web session	XP-702-F0-15TXIK-10
XP blind node (no display), 1.8 GHz Pentium, 2 GB RAM, 4 GB C drive, 1 GB D drive, 64k tags, 8 drivers, 1 Web session	XP-702-F0-BOXK-10

Visual Designer

Visual Designer Software



Description	Catalog Number
Visual Designer Development Software License Key	
For PCs, XPe and CE hardware	VISUALDXP
For PCs, XPe hardware, 5-pack of VISUALDXP	VISUALDXP5
For a PC Runtime software license with a maximum of 64k tags, 8 drivers, 1 Web session	VISUALRTPC
Visual Designer development software and PC runtime software licenses for a max of 64k tags, 8 drivers, 1 Web session	VISUALRTDEVP

Galileo Software

Galileo Development Software



Description	Catalog Number
Single-seat license	SW-GALILEO-S
Multiple-seat license	SW-GALILEO-M

XSoft-CoDeSys-2

XSoft-CoDeSys-2 Software



Description	Catalog Number
Single Seat License	SW-XSOFT-CODESYS-2-S
Multiple Seat License (3)	SW-XSOFT-CODESYS-2-M

X-ON Electronics

Largest Supplier of Electrical and Electronic Components

Click to view similar products for [eaton](#) manufacturer:

Other Similar products are found below :

[BK-MDL-3-R](#) [BK1-S506-500-R](#) [BK1-S506-6-3-R](#) [BK1-S506-2-R](#) [MPI4040R4-1R5-R](#) [TDC600-10A](#) [89096-015](#) [8946K153](#) [8961K155](#)
[M22-DL-W-X0](#) [M22-D-R-GB0/K11](#) [M22-L-R/R](#) [M22S-ST-GB12](#) [630NHG3B](#) [63ET](#) [6422](#) [6580](#) [CTX20-16-52LP-R](#) [CWL530FI](#)
[CXM/CO/GP/R/BB](#) [6HD36](#) [714125](#) [MBO-2](#) [ESR5-NO-41-24VAC-DC](#) [7314K36](#) [7321K2](#) [F02A-1-1/2A](#) [F02A-1-1/2AS](#) [F02A-1AS](#) [F02A-2AS](#) [F02A-3/4A](#) [F03A250V12A](#) [F03B125V4A](#) [MCR-4](#) [MDA-2-8/10-R](#) [MDA-30A](#) [MDA-V-1/16](#) [F60C500V10AS](#) [F60C500V15AS](#)
[7563K84](#) [7634K36](#) [MDQ-3/16](#) [MDQ-7/10](#) [MDQ-V-1/10](#) [MDQ-V-1-1/4](#) [MDQ-V-1/16](#) [MDQ-V-1/2](#) [MDQ-V-1/4](#) [MDQ-V-3/16](#) [MDQ-V-3/8](#)