



1 μ A, μ DFN/SC70, Lithium-Ion Battery, Precision Current-Sense Amplifier

General Description

The MAX9610 high-side current-sense amplifier offers precision accuracy specifications of V_{OS} less than 500 μ V (max) and gain error less than 0.5% (max). This device features an ultra-low 1 μ A quiescent supply current. The MAX9610 fits in a tiny, 1mm x 1.5mm μ DFN package or a 5-pin SC70 package, making this part ideal for applications in notebook computers, cell phones, cameras, PDAs, and all lithium-ion (Li+) battery-operated portable devices where accuracy, low quiescent current, and small size are critical.

The MAX9610 features an input voltage range (common mode) from 1.6V to 5.5V. This input range is excellent for monitoring the current of a single-cell, lithium-ion battery, which at full charge is 4.2V, typically 3.6V in normal use, and less than 2.9V when ready to be recharged. These current-sense amplifiers have a voltage output and are offered in three gain versions: 25V/V (MAX9610T), 50V/V (MAX9610F), and 100V/V (MAX9610H).

The three gain versions offer flexibility in the choice of the external current-sense resistor. The very low 500 μ V (max) input offset voltage allows small 25mV to 50mV full-scale V_{SENSE} voltage for very low voltage drop at full-load current measurement.

The MAX9610 is offered in tiny 6-pin μ DFN, (1mm x 1.5mm x 0.8mm footprint) and 5-pin SC70 packages, specified for operation over the -40°C to +85°C temperature range.

For a very similar 1.6V to 28V input voltage device in a 4-bump UCSP™ package (1mm x 1mm x 0.6mm), refer to the MAX9938 data sheet.

Applications

- Cell Phones
- Cameras
- Portable Li+ Battery Powered Systems
- 3.3V and 5V Power Management Systems
- PDAs
- USB Ports

Pin Configurations appear at end of data sheet.

UCSP is a trademark of Maxim Integrated Products, Inc.

Features

- ◆ Ultra-Low Supply Current of 1 μ A (max)
- ◆ Low 500 μ V (max) Input Offset Voltage
- ◆ Low < 0.5% (max) Gain Error
- ◆ Input Common Mode: +1.6V to +5.5V
- ◆ Voltage Output
- ◆ Three Gain Versions Available
 - 25V/V (MAX9610T)
 - 50V/V (MAX9610F)
 - 100V/V (MAX9610H)
- ◆ Tiny μ DFN (1mm x 1.5mm x 0.8mm) and SC70 Packages

Ordering Information

PART*	PIN-PACKAGE	GAIN (V/V)	TOP MARK
MAX9610TELT+T	6 μ DFN	25	OU
MAX9610FELT+T	6 μ DFN	50	OS
MAX9610HELT+T	6 μ DFN	100	OT
MAX9610TEXK+T	5 SC70	25	ATG
MAX9610FEXK+T	5 SC70	50	ATE
MAX9610HEXK+T	5 SC70	100	ATF

*All devices are specified over the -40°C to +85°C extended temperature range.

+Denotes a lead-free/RoHS-compliant package.

T = Tape and reel.

Typical Operating Circuit

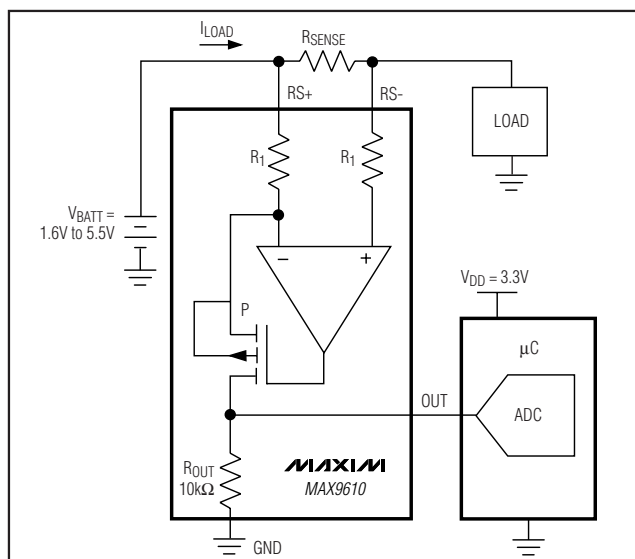

1 μ A, μ DFN/SC70, Lithium-Ion Battery, Precision Current-Sense Amplifier

ABSOLUTE MAXIMUM RATINGS

RS+, RS- to GND	-0.3V to +6V
OUT to GND	-0.3V to +6V
RS+ to RS-	\pm 6V
Short-Circuit Duration: OUT to GND or RS+	Continuous
Continuous Input Current (Any Pin)	\pm 20mA
Continuous Power Dissipation ($T_A = +70^\circ\text{C}$)	
5-Pin SC70 (derate 3.1mW/ $^\circ\text{C}$ above $+70^\circ\text{C}$)	247mW
6-Pin μ DFN (derate 2.1mW/ $^\circ\text{C}$ above $+70^\circ\text{C}$)	168mW

Operating Temperature Range	-40 $^\circ\text{C}$ to +85 $^\circ\text{C}$
Junction Temperature	+150 $^\circ\text{C}$
Storage Temperature Range	-65 $^\circ\text{C}$ to +150 $^\circ\text{C}$
Lead Temperature (soldering, 10s)	+300 $^\circ\text{C}$
Package Reflow Soldering Temperature	+260 $^\circ\text{C}$

Stresses beyond those listed under "Absolute Maximum Ratings" may cause permanent damage to the device. These are stress ratings only, and functional operation of the device at these or any other conditions beyond those indicated in the operational sections of the specifications is not implied. Exposure to absolute maximum rating conditions for extended periods may affect device reliability.

ELECTRICAL CHARACTERISTICS

($V_{RS+} = V_{RS-} = 3.6\text{V}$, $V_{SENSE} = (V_{RS+} - V_{RS-}) = 0$, $T_A = -40^\circ\text{C}$ to $+85^\circ\text{C}$, unless otherwise noted. Typical values are at $T_A = +25^\circ\text{C}$.) (Note 1)

PARAMETER	SYMBOL	CONDITIONS	MIN	TYP	MAX	UNITS
Supply Current (Note 2)	I _{CC}	$V_{RS+} = 3.6\text{V}$, $T_A = +25^\circ\text{C}$		0.6	1.0	μA
		$V_{RS+} = 3.6\text{V}$, $-40^\circ\text{C} < T_A < +85^\circ\text{C}$			1.4	
		$V_{RS+} = 5.5\text{V}$, $T_A = +25^\circ\text{C}$		0.75	1.2	
		$V_{RS+} = 5.5\text{V}$, $-40^\circ\text{C} < T_A < +85^\circ\text{C}$			1.6	
Common-Mode Input Range	V _{CM}	Guaranteed by CMRR, $-40^\circ\text{C} < T_A < +85^\circ\text{C}$	1.6		5.5	V
Common-Mode Rejection Ratio	CMRR	$1.6\text{V} < V_{RS+} < 5.5\text{V}$, $-40^\circ\text{C} < T_A < +85^\circ\text{C}$	80	104		dB
Input Offset Voltage	V _{OS}	$T_A = +25^\circ\text{C}$, gain = 25, 50, 100 (Note 3)		\pm 100	\pm 500	μV
		$-40^\circ\text{C} < T_A < +85^\circ\text{C}$	Gain = 25, 50		\pm 600	
			Gain = 100		\pm 700	
Gain	G	MAX9610T		25		V/V
		MAX9610F		50		
		MAX9610H		100		
Gain Error	GE	$T_A = +25^\circ\text{C}$, gain = 25, 50, 100 (Note 4)		\pm 0.1	\pm 0.5	%
		$-40^\circ\text{C} < T_A < +85^\circ\text{C}$	Gain = 25, 50		\pm 0.8	
			Gain = 100		\pm 1	
Output Resistance	R _{OUT}	$T_A = +25^\circ\text{C}$ (Note 5)	7.0	10	13.2	k Ω
OUT Low Voltage	V _{OL}	G = 25		2.5	15	mV
		G = 50		5	30	
		G = 100		10	70	
OUT High Voltage	V _{OH}	$V_{OH} = V_{RS-} - V_{OUT}$ (Note 6)		0.1	0.2	V

1μA, μDFN/SC70, Lithium-Ion Battery, Precision Current-Sense Amplifier

ELECTRICAL CHARACTERISTICS (continued)

($V_{RS+} = V_{RS-} = 3.6V$, $V_{SENSE} = (V_{RS+} - V_{RS-}) = 0$, $T_A = -40^{\circ}C$ to $+85^{\circ}C$, unless otherwise noted. Typical values are at $T_A = +25^{\circ}C$.)
(Note 1)

PARAMETER	SYMBOL	CONDITIONS	MIN	TYP	MAX	UNITS
Small-Signal Bandwidth	BW	$V_{SENSE} = 50mV$, $G = 25$		170		kHz
		$V_{SENSE} = 50mV$, $G = 50$		110		
		$V_{SENSE} = 50mV$, $G = 100$		60		
Output Settling Time	t_S	1% final value, $V_{SENSE} = 25mV$		35		μs
Power-Up Time	t_{ON}	1% final value, $V_{SENSE} = 25mV$		100		μs

Note 1: All devices are 100% production tested at $T_A = +25^{\circ}C$. All temperature limits are guaranteed by design.

Note 2: $V_{OUT} = 0V$. I_{CC} is the total current into $RS+$ plus $RS-$.

Note 3: V_{OS} is extrapolated from measurements for the Gain Error test.

Note 4: Gain Error is calculated by applying two values of V_{SENSE} and calculating the error of the slope, vs. the ideal:

$G = 25$: V_{SENSE} 20mV and 120mV

$G = 50$: V_{SENSE} 10mV and 60mV

$G = 100$: V_{SENSE} 5mV and 30mV

Note 5: The device is stable for any external capacitance value.

Note 6: V_{OH} is the voltage from V_{RS-} to V_{OUT} with $V_{SENSE} = 3.6V/Gain$.

Typical Operating Characteristics

($V_{RS+} = V_{RS-} = 3.6V$, $T_A = +25^{\circ}C$.)

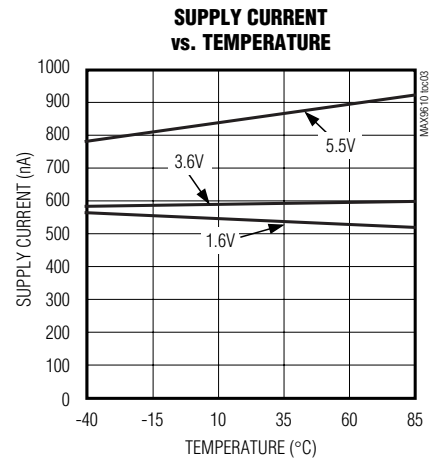
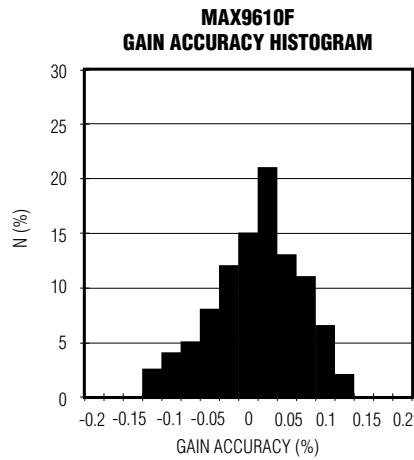
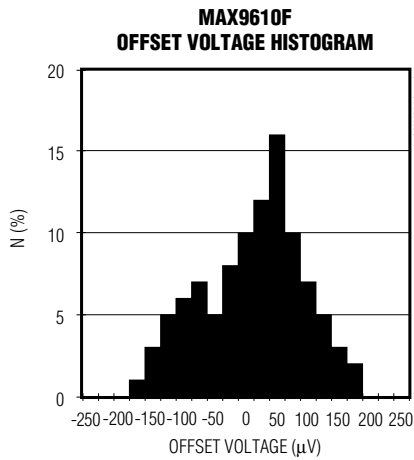

1 μ A, μ DFN/SC70, Lithium-Ion Battery, Precision Current-Sense Amplifier

Typical Operating Characteristics (continued)

($V_{RS+} = V_{RS-} = 3.6V$, $T_A = +25^\circ C$.)

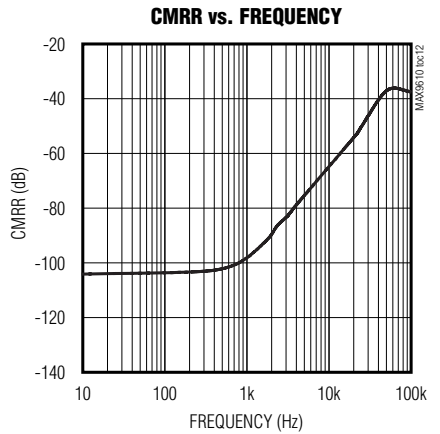
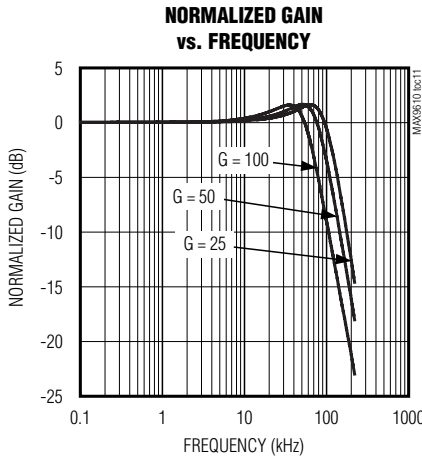
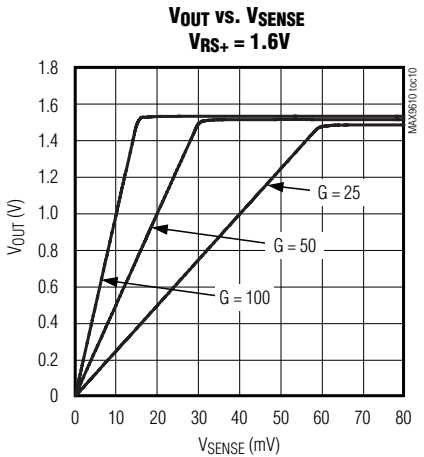
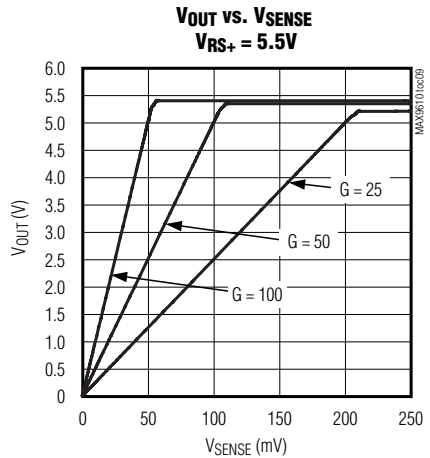
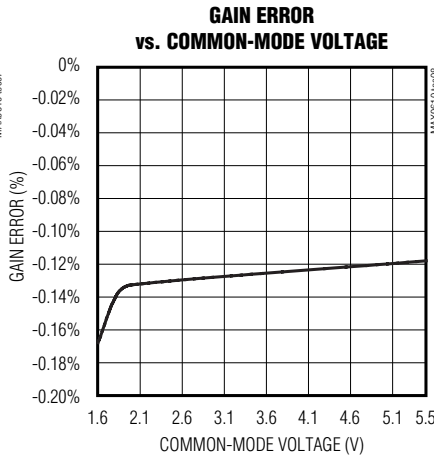
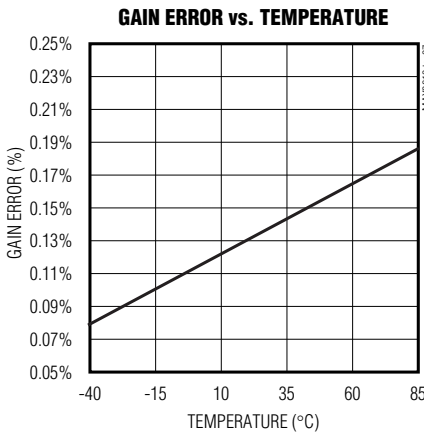
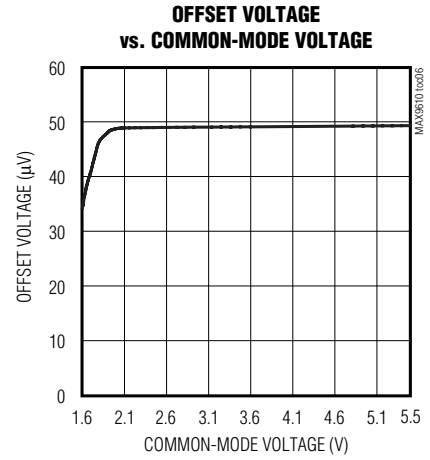
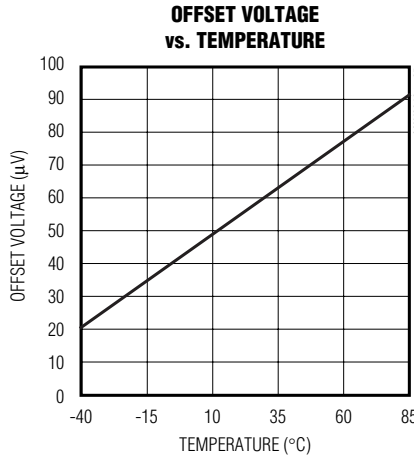
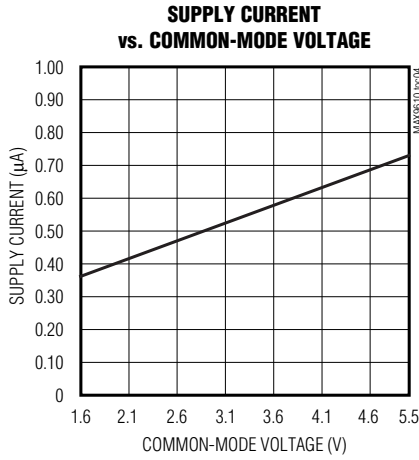

1μA, μDFN/SC70, Lithium-Ion Battery, Precision Current-Sense Amplifier

Typical Operating Characteristics (continued)

($V_{RS+} = V_{RS-} = 3.6V$, $T_A = +25^{\circ}C$.)

MAX9610

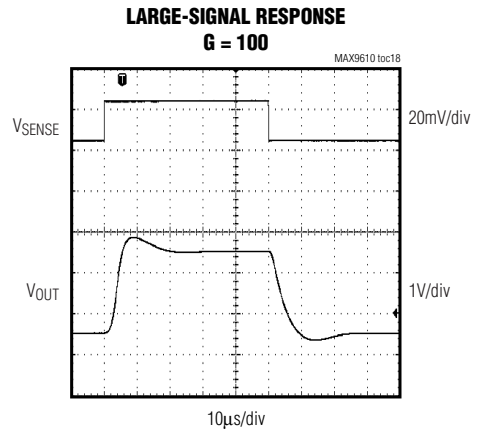
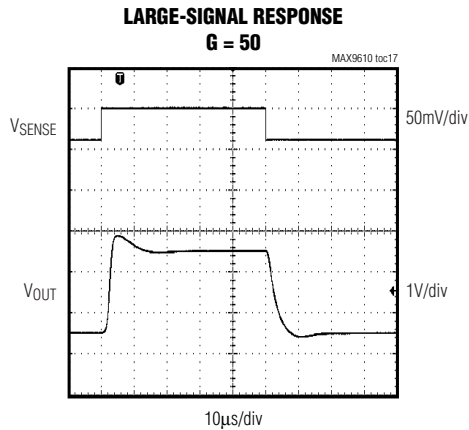
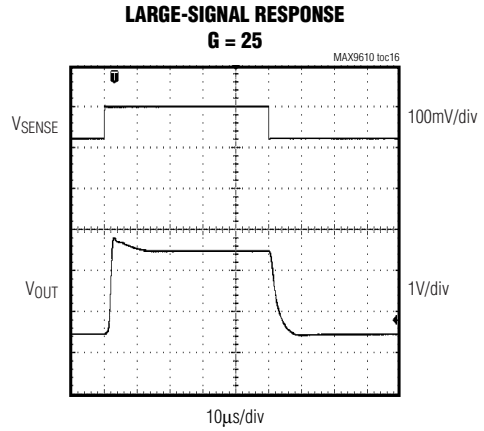
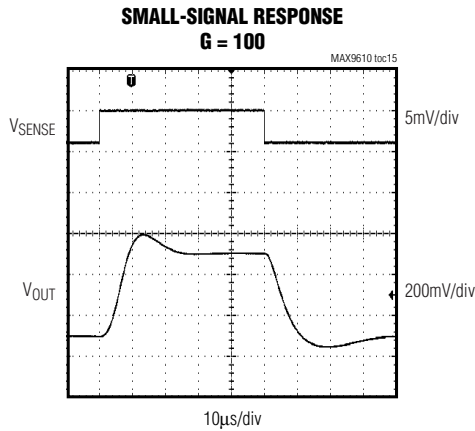
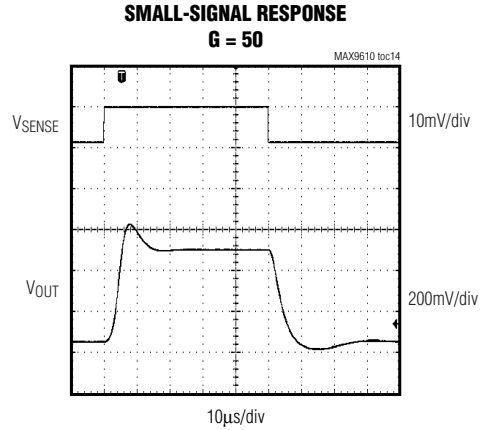
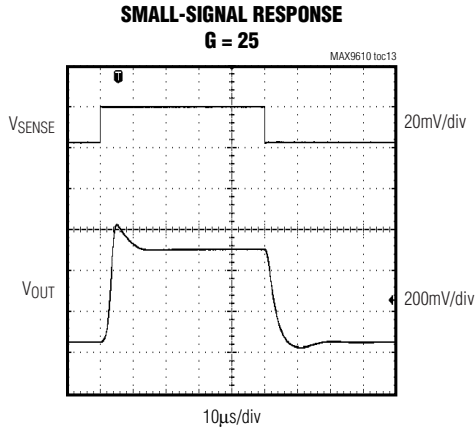

1 μ A, μ DFN/SC70, Lithium-Ion Battery, Precision Current-Sense Amplifier

Pin Description

PIN		NAME	FUNCTION
μ DFN	SC70		
1	1, 2	GND	Ground
2, 5	—	N.C.	No Connection. Not internally connected.
3	3	OUT	Output
4	4	RS-	Load-Side Connection to External Sense Resistor
6	5	RS+	Power-Side Connection to External Sense Resistor

Detailed Description

The MAX9610 family of unidirectional high-side, current-sense amplifiers features a 1.6V to 5.5V input common-mode range. The input range is excellent for monitoring the current of a single-cell lithium-ion battery (Li+), which at full charge is 4.2V, typically 3.6V in normal use, and less than 2.9V when ready to be recharged. The MAX9610 is ideal for many battery-powered, handheld devices because it uses only 1 μ A quiescent supply current to extend battery life. The MAX9610 monitors current through a current-sense resistor and amplifies the voltage across that resistor. See the *Typical Operating Circuit* on page 1.

The MAX9610 is a unidirectional current-sense amplifier that has a well-established history. An op amp is used to force the current through an internal gain resistor at RS+ that has a value of R₁, such that its voltage drop equals the voltage drop across an external sense resistor, R_{SENSE}. There is an internal resistor at RS- with the same value as R₁ to minimize offset voltage. The current through R₁ is sourced by a pFET. Its drain current is the same as its source current that flows through a second gain resistor, R_{OUT}. This produces an output voltage, V_{OUT}, whose magnitude is I_{LOAD} x R_{SENSE} x R_{OUT}/R₁. The gain accuracy is based on the matching of the two gain resistors R₁ and R_{OUT} (see Table 1). Total gain = 25V/V for the MAX9610T, 50V/V for the MAX9610F, and 100V/V for the MAX9610H.

Applications Information

Choosing the Sense Resistor

Choose R_{SENSE} based on the following criteria.

Voltage Loss

A high R_{SENSE} value causes the power-source voltage to drop due to IR loss. For minimal voltage loss, use the lowest R_{SENSE} value.

OUT Swing vs. V_{RS+} and V_{SENSE}

The MAX9610 is unique since the supply voltage is the input common-mode voltage (the average voltage at RS+ and RS-). There is no separate V_{CC} supply voltage input. Therefore, the OUT voltage swing is limited by the minimum voltage at RS+.

$$V_{OUT(MAX)} = V_{RS+(MAX)} - V_{SENSE(MAX)} - V_{OH}$$

and

$$R_{SENSE} = \frac{V_{OUT}}{G \times I_{LOAD(MAX)}}$$

V_{SENSE} full scale should be less than V_{OUT}/gain at the minimum RS+ voltage. For best performance with a 3.6V supply voltage, select R_{SENSE} to provide approximately 120mV (gain of 25V/V), 60mV (gain of 50V/V), or 30mV (gain of 100V/V) of sense voltage for the full-scale current in each application. These can be increased by use of a higher minimum input voltage.

Accuracy

In the linear region (V_{OUT} < V_{OUT(MAX)}), there are two components to accuracy: input offset voltage (V_{OS}) and Gain Error (GE). The MAX9610 has V_{OS} = 500 μ V (max) and Gain Error of 0.5% (max). Use the following linear equation to calculate total error.

$$V_{OUT} = (\text{Gain} \pm \text{GE}) \times V_{SENSE} \pm (\text{Gain} \times V_{OS})$$

A high R_{SENSE} value allows lower currents to be measured more accurately because offsets are less significant when the sense voltage is larger.

Efficiency and Power Dissipation

At high current levels, the I²R loss in R_{SENSE} can be significant. Take this into consideration when choosing the resistor value and its power dissipation (wattage) rating. Also, the sense resistor's value might drift if it is allowed to heat up excessively. The precision V_{OS} of the MAX9610 allows the use of small sense resistors to reduce power dissipation and reduce hot spots.

Table 1. MAX9610, Internal Gain Setting Resistors (Typical Values)

GAIN (V/V)	R ₁ (Ω)	R _{OUT} (Ω)
100	100	10k
50	200	10k
25	400	10k

1 μ A, μ DFN/SC70, Lithium-Ion Battery, Precision Current-Sense Amplifier

MAX9610

Kelvin Connections

Because of the high currents that flow through R_{SENSE} , take care to eliminate parasitic trace resistance from causing errors in the sense voltage. Either use a four terminal current-sense resistor or use Kelvin (force and sense) PCB layout techniques.

Optional Output Filter Capacitor

When designing a system that uses a sample and hold stage in the analog-to-digital converter, the sampling capacitor momentarily loads OUT and causes a drop in the output voltage. If sampling time is very short (less than a microsecond), consider using a ceramic capacitor across OUT and GND to hold V_{OUT} constant during sampling. This also decreases the small-signal bandwidth of the current-sense amplifier and reduces noise at OUT.

Typical Application Circuit

Bidirectional Application

Battery-powered systems may require a precise bidirectional current-sense amplifier to accurately monitor the battery's charge and discharge currents. Measurements of the two separate outputs with respect to GND yield an accurate measure of the charge and discharge currents, respectively (Figure 1).

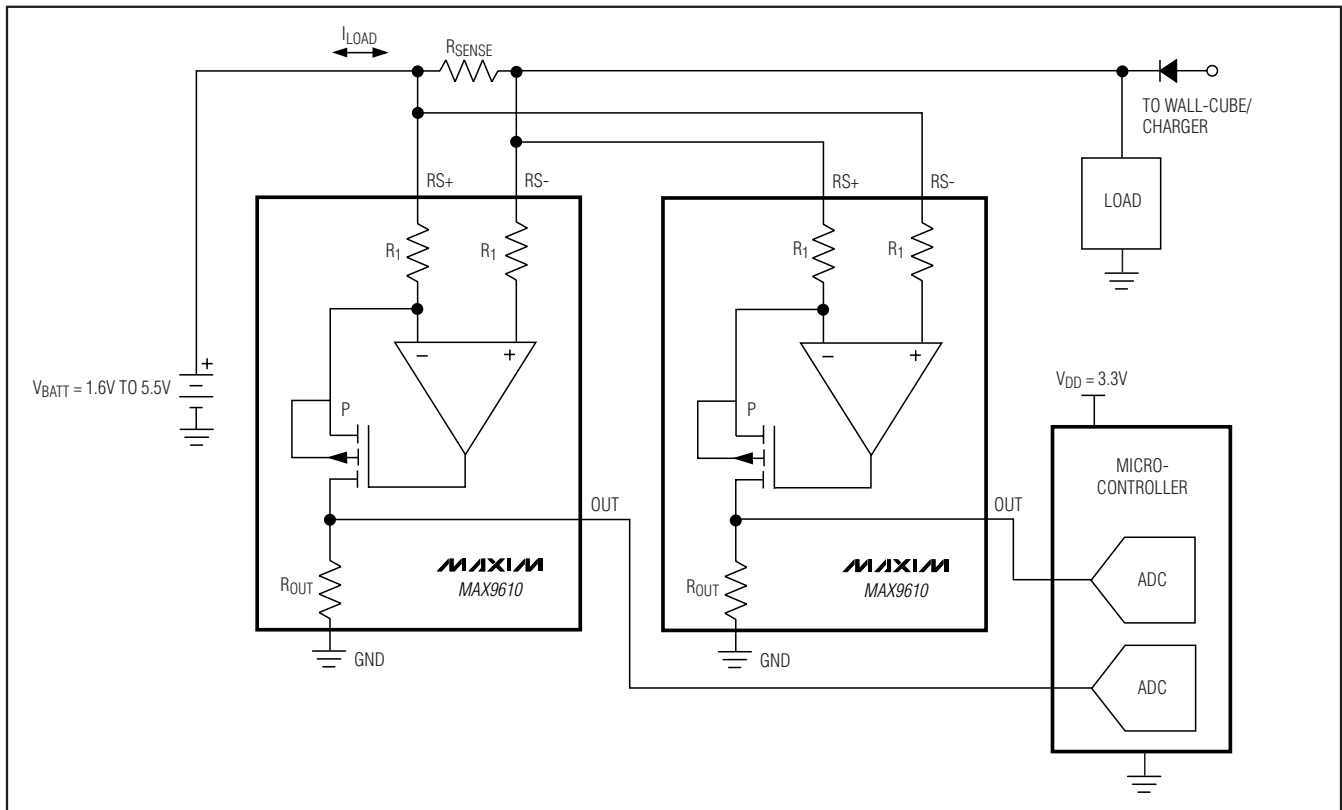

Figure 1. Bidirectional Application

1 μ A, μ DFN/SC70, Lithium-Ion Battery, Precision Current-Sense Amplifier

Pin Configurations

Chip Information

PROCESS: BiCMOS

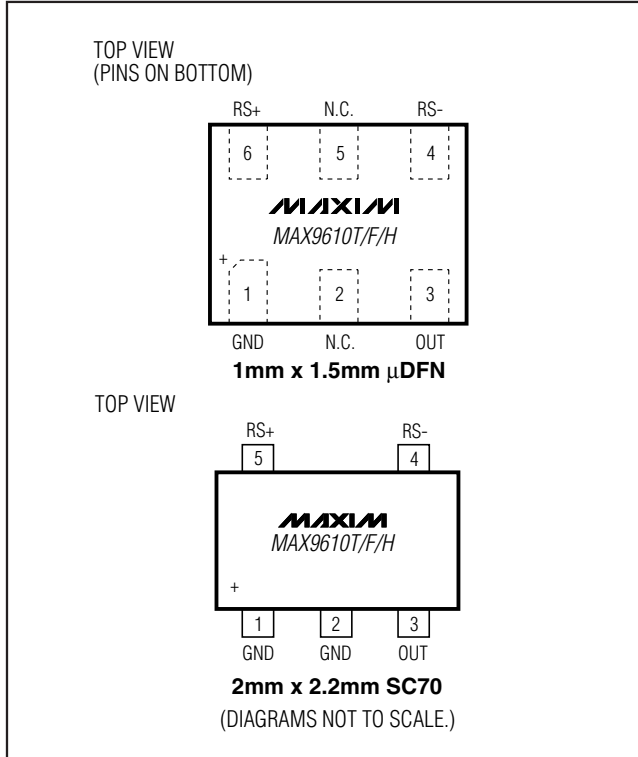

1 μ A, μ DFN/SC70, Lithium-Ion Battery, Precision Current-Sense Amplifier

Package Information

For the latest package outline information and land patterns, go to www.maxim-ic.com/packages.

PACKAGE TYPE	PACKAGE CODE	DOCUMENT NO.
6 μ DFN	L611+1	21-0147
5 SC70	X5+1	21-0076

MAX9610

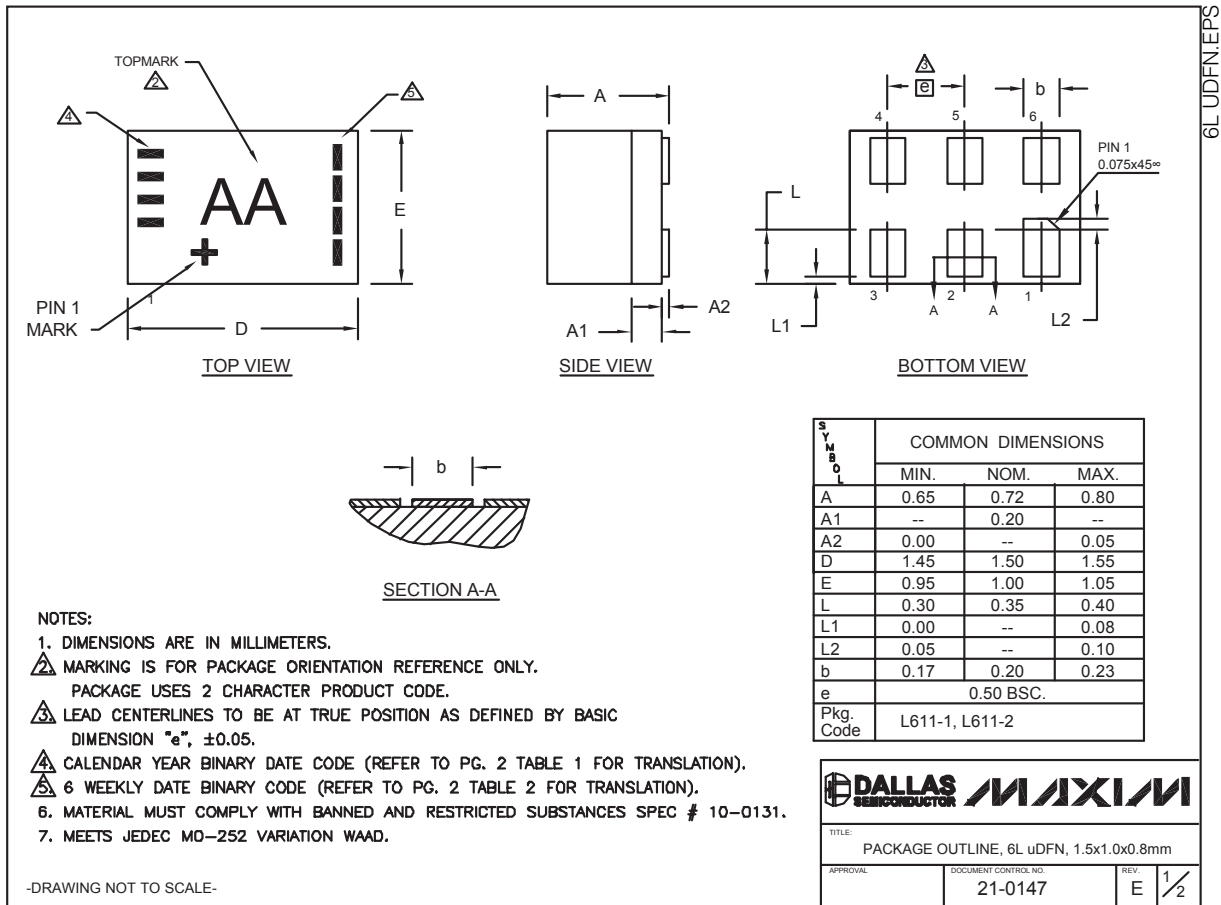

6L uDFN LEPS

1μA, μDFN/SC70, Lithium-Ion Battery, Precision Current-Sense Amplifier

Package Information (continued)

For the latest package outline information and land patterns, go to www.maxim-ic.com/packages.

TABLE 1 Translation Table for Calendar Year Code

Calendar Year	2005	2006	2007	2008	2009	2010	2011	2012	2013	2014

Legend: Marked with bar Blank space - no bar required

TABLE 2 Translation Table for Payweek Binary Coding

Payweek	06-11	12-17	18-23	24-29	30-35	36-41	42-47	48-51	52-05

Legend: Marked with bar Blank space - no bar required

TITLE: PACKAGE OUTLINE, 6L μDFN, 1.5x1.0x0.8mm	
APPROVAL	DOCUMENT CONTROL NO. 21-0147
REV. E	2/2

-DRAWING NOT TO SCALE-

1 μ A, μ DFN/SC70, Lithium-Ion Battery, Precision Current-Sense Amplifier

Package Information (continued)

For the latest package outline information and land patterns, go to www.maxim-ic.com/packages.

MAX9610

SC70, 5L.EPS

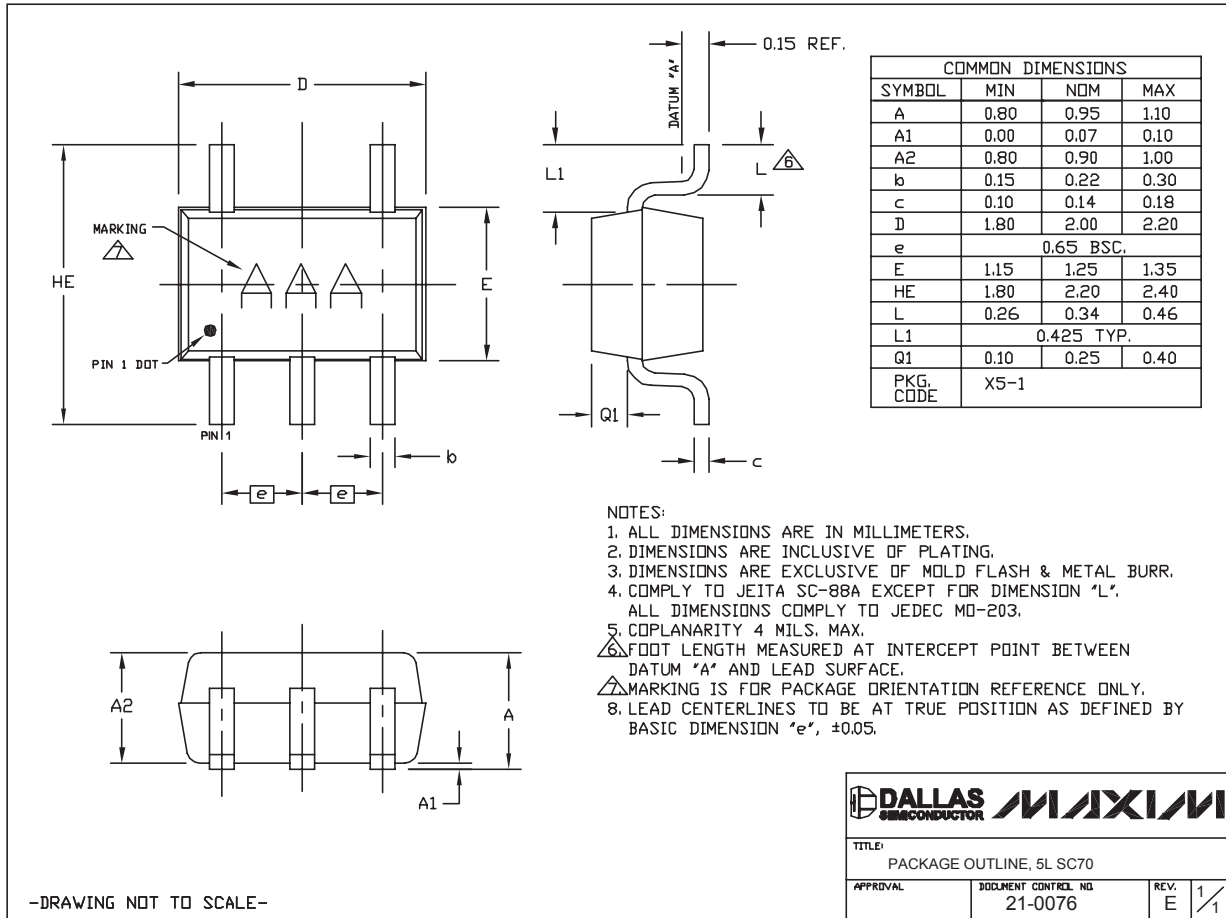

Maxim cannot assume responsibility for use of any circuitry other than circuitry entirely embodied in a Maxim product. No circuit patent licenses are implied. Maxim reserves the right to change the circuitry and specifications without notice at any time.

Maxim Integrated Products, 120 San Gabriel Drive, Sunnyvale, CA 94086 408-737-7600 _____ 11

X-ON Electronics

Largest Supplier of Electrical and Electronic Components

Click to view similar products for [maxim](#) manufacturer:

Other Similar products are found below :

[MAX9709EVKIT](#) [MAX6705ATKA+](#) [MAX6710JUT+](#) [MAX6314US46D3+](#) [MAX6324BUT29+](#) [MAX4613EUE+](#) [MAX4451EKA+](#)
[MAX6817EUT+](#) [MAX6390XS29D4+](#) [LM4040BIM3-2.5+](#) [MAX6323CUT29+](#) [MAX6035AAUR25+](#) [MAX4165EUK+](#) [DS2432P+](#)
[MAX5401EKA+](#) [MAX6831SFUT+](#) [MAX6455UT26S+](#) [MAX14527ETA+](#) [MAX6642ATT90+](#) [MAX4516CUK+](#) [MAX4599EXT+](#)
[MAX6605MXK+](#) [MAX1697TEUT+](#) [MAX3283EAUT+](#) [MAX3370EXK+](#) [MAX4627EUK+](#) [GROUP A 5962-8877003PA](#) [MAX4684EBC+](#)
[MAX5385EUT+](#) [MAX6719UTSVD3+](#) [MAX4124EUK+](#) [MAX17049G+](#) [DG202AK](#) [DS26514GN+](#) [MAX6863UK29+](#) [MAX824REUK+](#)
[MAX9110EKA+](#) [MAX5161NEZT+](#) [MAX3202EETT+](#) [MAX1558HETB+](#) [MAX3280EAUK+](#) [MAX44280AYT+](#) [MAX6315US26D3+](#)
[MAX6315US29D1+](#) [MAX6423XS16+](#) [MAX1338ETN+](#) [MAX5860FUXH+](#) [MAX6747KA23+](#) [MAX6719UTSHD3+](#) [MAX5969AETB+](#)