

# Description and Handling PCB Terminal Strips with CAGE CLAMP® Series 233 and 234

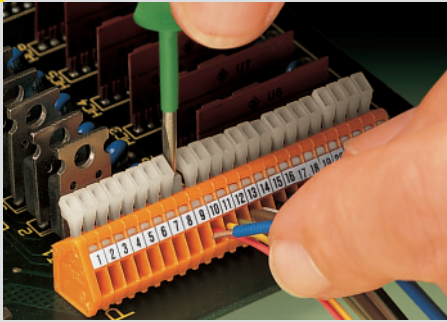

Connection/removal of conductors

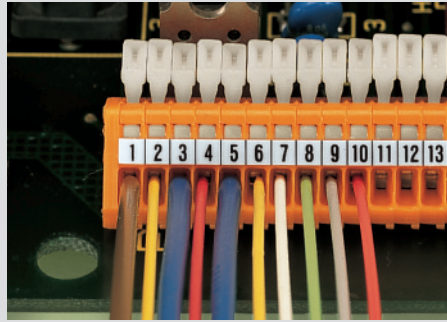

Rated cross section 0.5 mm<sup>2</sup>/AWG 20,  
in adjacent positions 0.75 mm<sup>2</sup>/AWG 18



Marking with self-adhesive marker strips  
or with customized direct printing

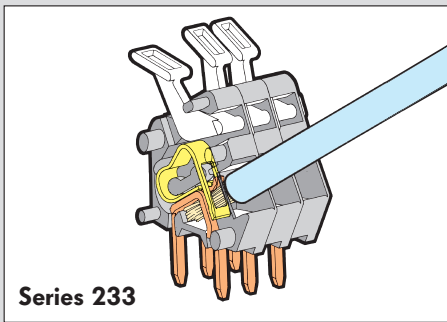

Series 233

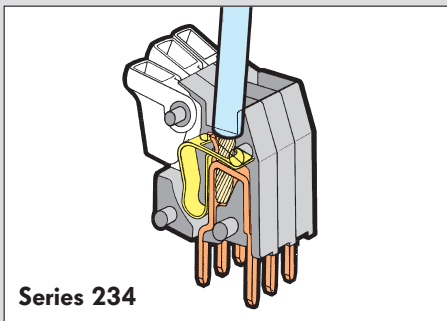

Series 234

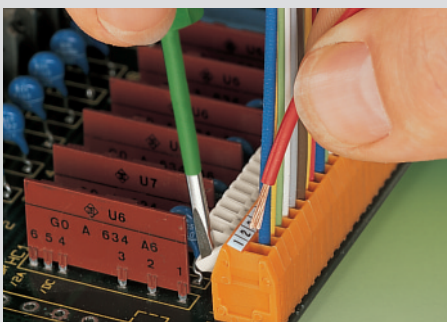
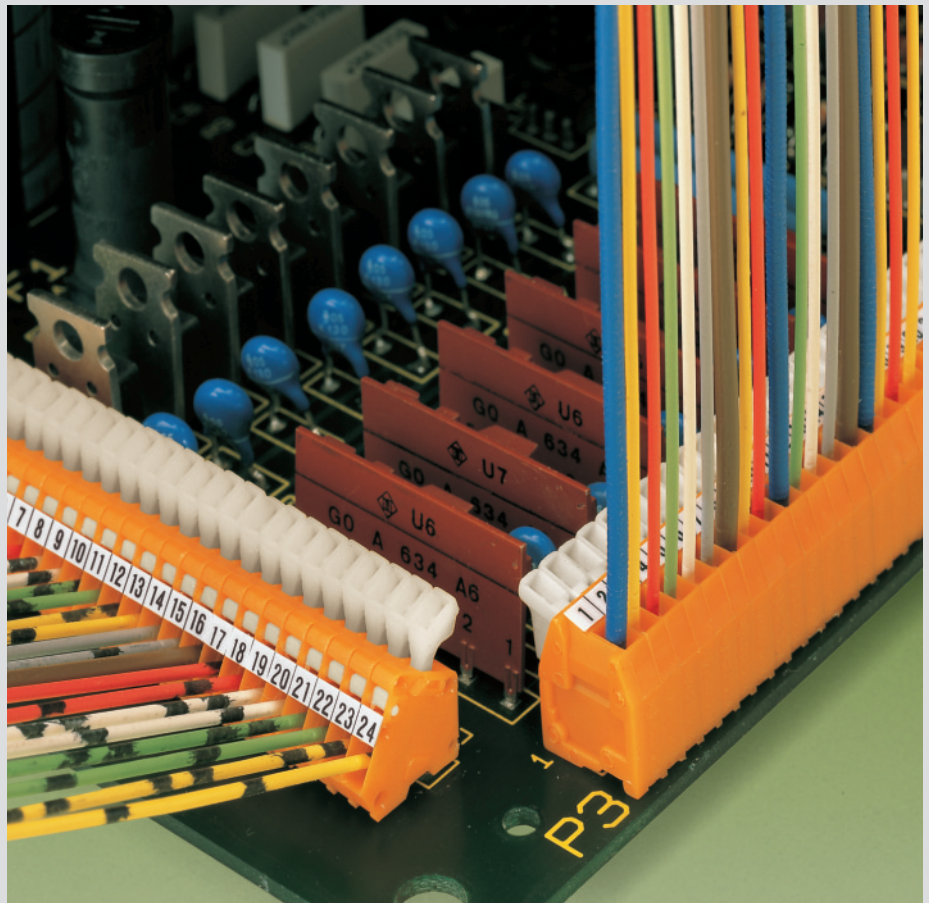

Connection/removal of conductors



Rated cross section 0.5 mm<sup>2</sup>/AWG 20,  
in adjacent positions 0.75 mm<sup>2</sup>/AWG 18

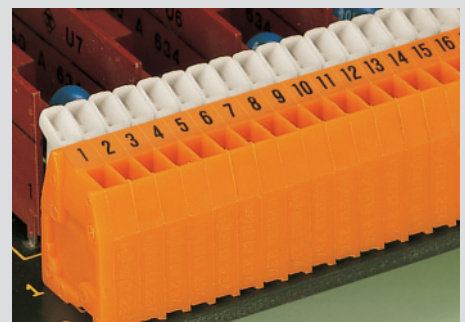

Marking with self-adhesive marker strips  
or with customized direct printing

CAGE CLAMP®  
connects the following  
copper wires:\*

solid

stranded

fine-stranded,  
also with tinned  
single strands



fine-stranded wire –  
tip bonded

\* For aluminum wires see notes in section 12!

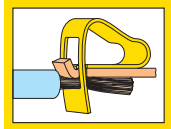
# PCB Terminal Strips 0.5 mm<sup>2</sup>/AWG 20 Pin Spacings 2.5 mm / 0.098 in and 2.54 mm / 0.1 in; Series 234

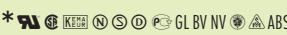

1  
11

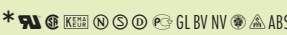
<p><b>Pin spacing 2.5 mm/0.098 in</b> 0.08 – 0.5 mm<sup>2</sup> ①   AWG 28 – 20 ① 250 V/2.5 kV/2   150 V, 4 A ② ③ 6 A</p> <p> 5 – 6 mm / 0.22 in</p> <p>* </p>	<p><b>Pin spacing 2.54 mm/0.1 in</b> 0.08 – 0.5 mm<sup>2</sup> ①   AWG 28 – 20 ① 250 V/2.5 kV/2   150 V, 4 A ② ③ 6 A</p> <p> 5 – 6 mm / 0.22 in</p> <p>* </p>	<p><b>Accessories</b></p>
--	---	---------------------------

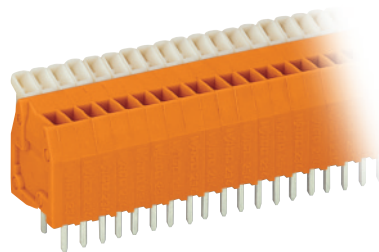
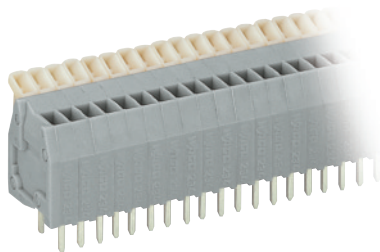

No. of poles	Item No.	Pack.-unit pcs	No. of poles	Item No.	Pack.-unit pcs	Item No.	Pack.-unit pcs	
Terminal strips with push buttons, standard lengths, other lengths contact factory, 2 solder pins/pole, grey			Terminal strips with push buttons, standard lengths, other lengths contact factory, 2 solder pins/pole, orange			Marker cards, 100 self-adhesive strips per card		
2	234-202	600 (6 x 100)	2	234-502	600 (6 x 100)	Marking - pin spacing 2.5 mm/0.098 in 	1 card	
3	234-203	520 (4 x 130)	3	234-503	520 (4 x 130)			1-16 (400 x) <b>210-331/0250-0202</b>
4	234-204	400 (4 x 100)	4	234-504	400 (4 x 100)			17-32 (400 x) <b>210-331/0250-0204</b>
5	234-205	340 (4 x 85)	5	234-505	340 (4 x 85)	33-48 (400 x) <b>210-331/0250-0206</b>	1 card	
6	234-206	280 (4 x 70)	6	234-506	280 (4 x 70)	Marking - pin spacing 2.54 mm/0.1 in	1 card	
7	234-207	240 (4 x 60)	7	234-507	240 (4 x 60)			1-16 (400 x) <b>210-331/0254-0202</b>
8	234-208	220 (4 x 55)	8	234-508	220 (4 x 55)			17-32 (400 x) <b>210-331/0254-0204</b>
9	234-209	200 (4 x 50)	9	234-509	200 (4 x 50)	33-48 (400 x) <b>210-331/0254-0206</b>	1 card	
10	234-210	180 (4 x 45)	10	234-510	180 (4 x 45)	For direct printing, please contact factory		
12	234-212	140 (4 x 35)	12	234-512	140 (4 x 35)			
16	234-216	100 (4 x 25)	16	234-516	100 (4 x 25)			
24	234-224	80 (4 x 20)	24	234-524	80 (4 x 20)			
For other colors, please contact factory			For other colors, please contact factory					

## Dimensions (in mm)

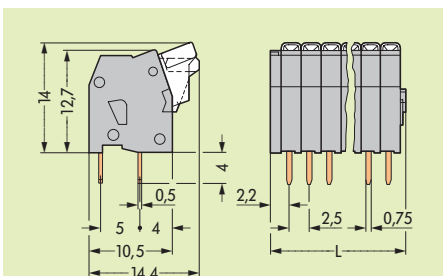

Diameter of drilled hole: 1.1<sup>+0.1</sup> mm  
L = (No. of poles x pin spacing) + 2.2 mm

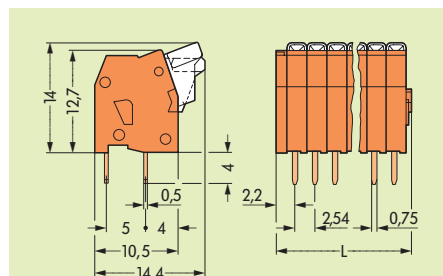

Diameter of drilled hole: 1.1<sup>+0.1</sup> mm  
L = (No. of poles x pin spacing) + 2.2 mm

① in adjacent positions 0.75 mm<sup>2</sup>/AWG 18

\* Approvals with corresponding ratings see pages 12.3 ff.

## X-ON Electronics

Largest Supplier of Electrical and Electronic Components

*Click to view similar products for [wago manufacturer](#):*

Other Similar products are found below :

[750-460](#) [231-118/026-000](#) [231-303/026-000](#) [231-620/019-000](#) [257-403](#) [280-438](#) [280-831](#) [284-624](#) [210-111](#) [231-303/037-000](#) [231-446/001-000\\_NR](#) [232-216/026-000](#) [234-510](#) [264-726](#) [280-339](#) [0283-0671](#) [830-800/000-305](#) [750-512](#) [750-455](#) [51251782](#) [286-312](#) [713-1428/107-000](#) [731-138/048-000](#) [750-459](#) [750-517](#) [793-3505](#) [826-172](#) [859-304](#) [280-335](#) [231-535/001-000](#) [2604-1106](#) [2604-1504](#) [2606-1103/020-000](#) [2624-1103](#) [2626-3103/020-000](#) [821-104](#) [713-1107](#) [852-1411](#) [2106-1307](#) [2116-5307](#) [832-1205](#) [832-3604](#) [2009-110](#) [281-512/281-501](#) [286-336](#) [750-421](#) [750-838](#) [753-559](#) [750-1505](#) [787-732](#)