

THE INFORMATION CONTAINED IN THIS DOCUMENT IS THE PROPERTY OF LUMEX INC. EXCEPT AS SPECIFICALLY AUTHORIZED IN WRITING BY LUMEX INC., THE HOLDER OF THIS DOCUMENT SHALL KEEP ALL INFORMATION CONTAINED HEREIN CONFIDENTIAL AND SHALL PROTECT SAME IN WHOLE OR IN PART FROM DISCLOSURE AND DISSEMINATION TO ALL THIRD PARTIES.  
CONFIDENTIAL INFORMATION

\*\*THE SPECIFICATIONS MAY CHANGE AT ANY TIME WITHOUT NOTICE DUE TO NEW MATERIALS OR PRODUCT IMPROVEMENT.\*\*

12mm x 12mm SURFACE MOUNT LED, WARM WHITE.

DATE:	02.04.11	UNIT:	mm [INCH]
DRAWN BY:	AB	SCALE:	APRVD BY: BC
CHKD BY:	KF	PAGE:	1 OF 4

\*UNLESS OTHERWISE SPECIFIED TOLERANCES PER DECIMAL PRECISION ARE: X=±1 (±0.039), XX=±0.5 (±0.020), XXX=±0.25 (±0.010), XXXX=±0.127 (±0.005), LEAD SIZE=±0.05 (±0.002), LEAD LENGTH=±0.75 (±0.030), MIN=-0.00, DECIMAL PRECISION MAX=-0.00, PRECISION UNCONTROLLED DOCUMENT

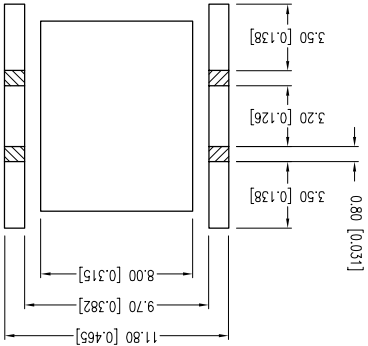

RECOMMENDED SOLDER PAD LAYOUT

CAUTION: MOISTURE SENSITIVE DEVICE  
PER JEDEC LEVEL 2 STANDARDS

CAUTION: STATIC SENSITIVE DEVICE  
FOLLOW PROPER E.S.D. HANDLING PROCEDURES  
WHEN WORKING WITH THIS PART.

PARAMETER	UNITS	MAX
JUNCTION TEMPERATURE	°C	110
THERMAL RESISTANCE (JUNCTION/SOLDER)	°C/W	3.5
TEMPERATURE COEFFICIENT OF $V_f$	mV/°C	-5.6

PARAMETER	UNITS	MAX
PEAK FORWARD CURRENT	mA	1200
STEADY CURRENT	mA	1000
POWER DISSIPATION	mW	11.5
OPERATING TEMP.	°C	-40 TO +90
STORAGE TEMP.	°C	-40 TO +100

LIMITS OF SAFE OPERATION AT 25°C

PARAMETER	SYMBOL	MIN	TYP	MAX	UNITS	TEST COND
FORWARD VOLTAGE	$V_f$	9.3	10.4	11.5	V	$I_f=1000\text{mA}$
REVERSE VOLTAGE	$V_r$	15			V	$I_r=10\mu\text{A}$
LUMINOUS FLUX	$I_v$	430	530		lm	$I_f=1000\text{mA}$
COLOR TEMPERATURE		2870	3000	3220	K	
VIEWING ANGLE			120		2x theta	
EMITTED COLOR:						WARM WHITE
EPOXY LENS FINISH:						WATER CLEAR LENS

ELECTRO-OPTICAL CHARACTERISTICS  $T_A=25^\circ\text{C}$ ,  $I_f=1000\text{mA}$

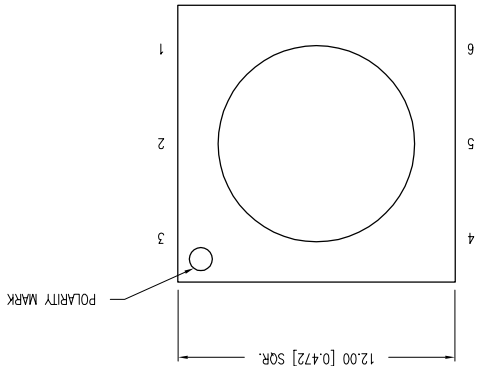
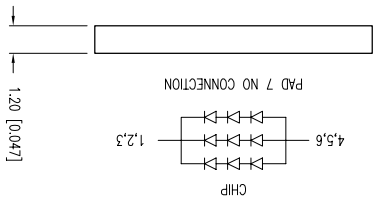
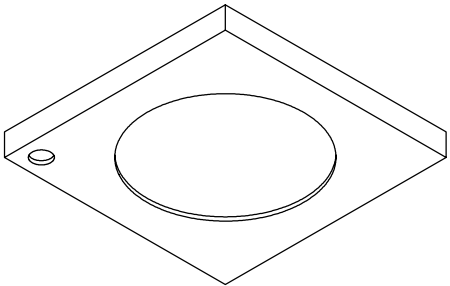

CONFIDENTIAL INFORMATION  
 THE INFORMATION CONTAINED IN THIS DOCUMENT IS THE PROPERTY OF LUMEX INC. EXCEPT AS SPECIFICALLY AUTHORIZED IN WRITING BY LUMEX INC., THE HOLDER OF THIS DOCUMENT SHALL  
 KEEP ALL INFORMATION CONTAINED HEREIN CONFIDENTIAL AND SHALL PROTECT SAME IN WHOLE OR IN PART FROM DISCLOSURE AND DISSEMINATION TO ALL THIRD PARTIES.

\*\*THE SPECIFICATIONS MAY CHANGE AT ANY TIME WITHOUT NOTICE DUE TO NEW MATERIALS OR PRODUCT IMPROVEMENT.\*\*

DATE: 02.04.11	DRAWN BY: AB
PAGE: 3 OF 4	CHKD BY: KF
SCALE:	APRD BY: BC
UNIT: mm [INCH]	

\*UNLESS OTHERWISE SPECIFIED TOLERANCES PER DECIMAL PRECISION ARE: X=±1 (±0.039), Y=±0.5 (±0.020), Z=±0.25 (±0.010), X.XXX=±0.127 (±0.005), LEAD SIZE=±0.05 (±0.002), LEAD LENGTH=±0.75 (±0.030), MIN=-0.00, +DECIMAL PRECISION MAX=+0.00, -DECIMAL PRECISION MIN=-0.00

5	0.4465 0.4071	0.4562 0.4260	0.4430 0.4212	0.4342 0.4028	0.4017 0.3751	0.4147 0.3814	0.3825 0.3798	0.3568 0.3495	0.3265 0.3371
4	0.4483 0.3919	0.4582 0.4099	0.4465 0.4071	0.4373 0.3893	0.4080 0.3916	0.4146 0.4089	0.3783 0.3646	0.3592 0.3641	0.3260 0.3512
3	0.4582 0.4099	0.4687 0.4289	0.4465 0.4071	0.4582 0.4099	0.4221 0.3984	0.4342 0.4028	0.4006 0.4044	0.3568 0.3495	0.3265 0.3371
2	0.4593 0.3944	0.4700 0.4126	0.4430 0.4212	0.4593 0.3944	0.4342 0.4028	0.4430 0.4212	0.4017 0.3751	0.3703 0.3726	0.3466 0.3411
1	0.4582 0.4099	0.4700 0.4126	0.4430 0.4212	0.4582 0.4099	0.4221 0.3984	0.4342 0.4028	0.4080 0.3916	0.3783 0.3646	0.3592 0.3641

COLOR	GROUP	CHROMATICITY REGIONS	MIN. TYP. MAX.
COOL WHITE	C1	23,24,25,26,27,28	5310 6000 7040
WARM WHITE	N2	17,18,19,20,21,22	4260 4700 5310
WARM WHITE	N1	13,14,15,16	3710 4000 4260
WARM WHITE	W3	9,10,11,12	3220 3500 3710
WARM WHITE	W2	5,6,7,8	2870 3000 3220
WARM WHITE	W1	1,2,3,4	2580 2700 2870

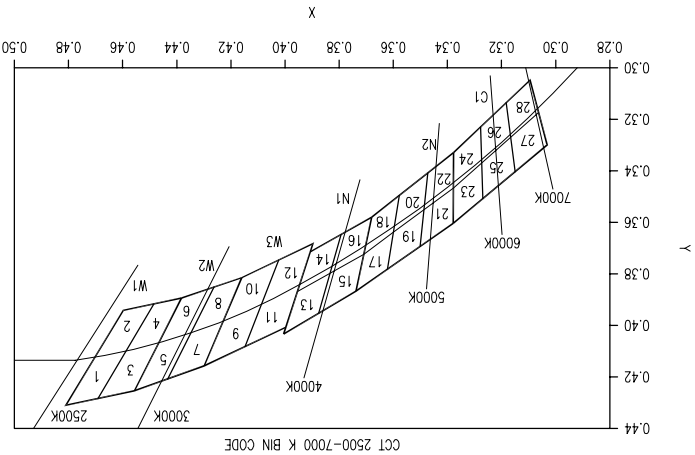

CONFIDENTIAL INFORMATION  
 THE INFORMATION CONTAINED IN THIS DOCUMENT IS THE PROPERTY OF LUMEX INC. EXCEPT AS SPECIFICALLY AUTHORIZED IN WRITING BY LUMEX INC., THE HOLDER OF THIS DOCUMENT SHALL KEEP ALL INFORMATION CONTAINED HEREIN CONFIDENTIAL AND SHALL PROTECT SAME IN WHOLE OR IN PART FROM DISCLOSURE AND DISSEMINATION TO ALL THIRD PARTIES.

\*\*THE SPECIFICATIONS MAY CHANGE AT ANY TIME WITHOUT NOTICE DUE TO NEW MATERIALS OR PRODUCT IMPROVEMENT.\*\*

12mm x 12mm SURFACE MOUNT LED, WARM WHITE.

DATE: 02.04.11	DRAWN BY: AB
PAGE: 2 OF 4	CHKD BY: KF
SCALE:	APRVD BY: BC
UNIT: mm [INCH]	

\*UNLESS OTHERWISE SPECIFIED TOLERANCES PER DECIMAL PRECISION ARE: X=±1 (±0.039), XX=±0.5 (±0.020), XXX=±0.25 (±0.010), XXXX=±0.127 (±0.005). LEAD SIZE=±0.05 (±0.002), LEAD LENGTH=±0.75 (±0.030), MIN=-0.00 -DECIMAL PRECISION MAX=+0.00 -DECIMAL PRECISION UNCONTROLLED DOCUMENT

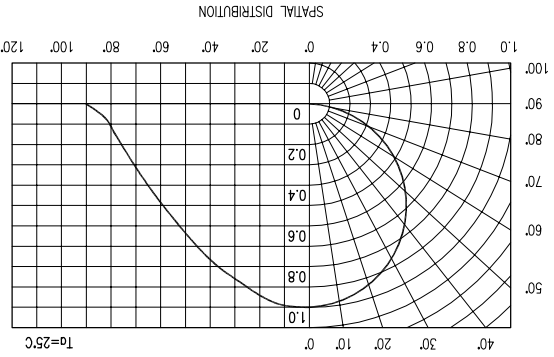
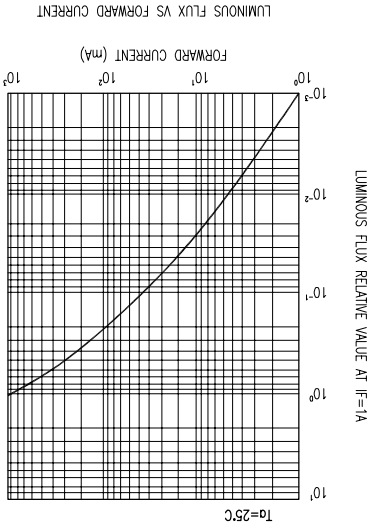
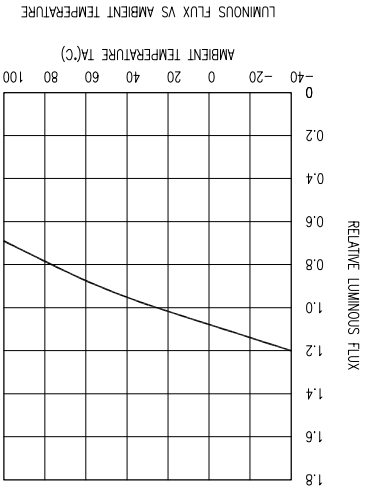
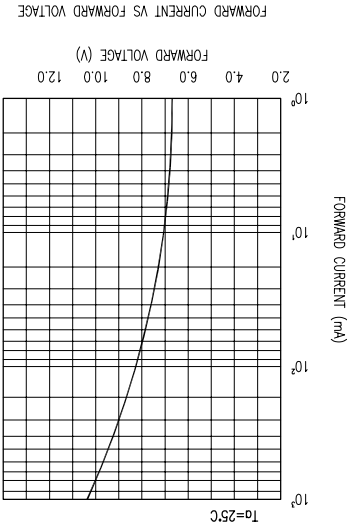
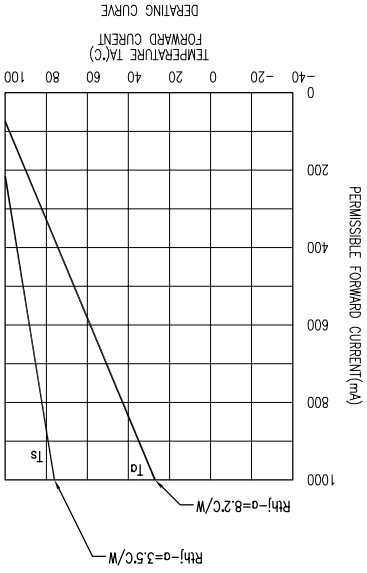

12mm x 12mm SURFACE MOUNT LED, WARM WHITE.  
 \*\*THE SPECIFICATIONS MAY CHANGE AT ANY TIME WITHOUT NOTICE DUE TO NEW MATERIALS OR PRODUCT IMPROVEMENT.\*\*  
 CONFIDENTIAL INFORMATION  
 THE INFORMATION CONTAINED IN THIS DOCUMENT IS THE PROPERTY OF LUMEX INC. EXCEPT AS SPECIFICALLY AUTHORIZED IN WRITING BY LUMEX INC., THE HOLDER OF THIS DOCUMENT SHALL KEEP ALL INFORMATION CONTAINED HEREIN CONFIDENTIAL AND SHALL PROTECT SAME IN WHOLE OR IN PART FROM DISCLOSURE AND DISSEMINATION TO ALL THIRD PARTIES.

DATE: 02.04.11	DRAWN BY: AB
PAGE: 4 OF 4	CHKD BY: KF
SCALE:	APRVD BY: BC
UNIT: mm [INCH]	

\*UNLESS OTHERWISE SPECIFIED TOLERANCES PER DECIMAL PRECISION ARE: X=±1 (±0.039), XX=±0.5 (±0.020), XXX=±0.25 (±0.010), XXXX=±0.127 (±0.005), LEAD SIZE=±0.05 (±0.002), LEAD LENGTH=±0.75 (±0.030), MIN=-0.00, +DECIMAL PRECISION MAX.=+0.00, -DECIMAL PRECISION MIN=-0.00

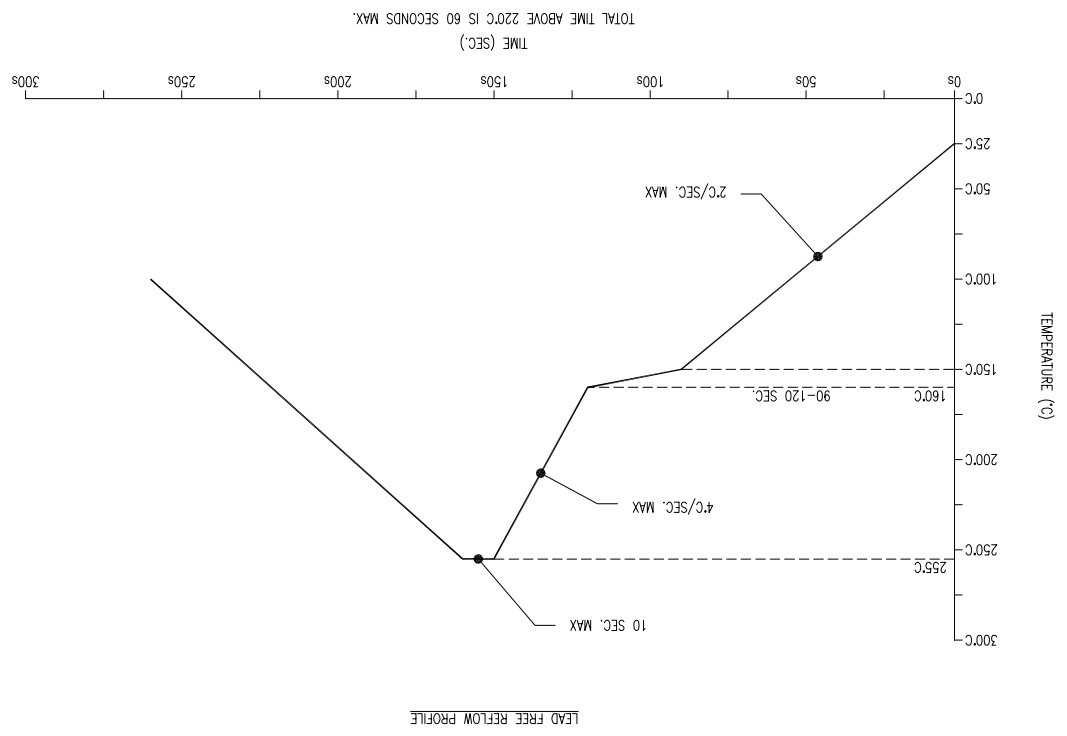
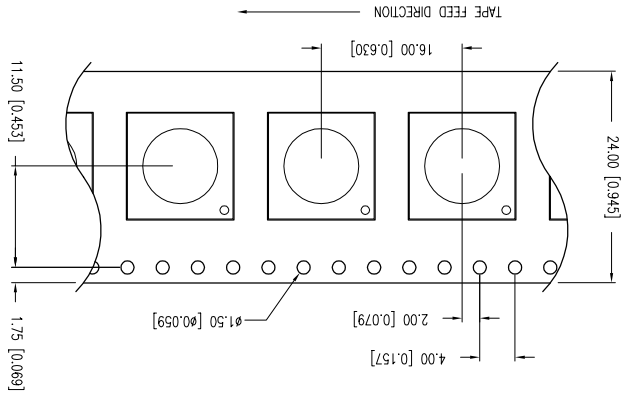

## X-ON Electronics

Largest Supplier of Electrical and Electronic Components

*Click to view similar products for [High Power LEDs - White category](#):*

*Click to view products by [Lumex manufacturer](#):*

Other Similar products are found below :

[G42180-08](#) [B42180-08](#) [STW8Q2PA-R5-HA](#) [SZ5-M1-W0-00-V3/W2-AA](#) [LTPL-P00DWS57](#) [LZP-D0WW00-0000](#) [CLM-9-30-90-36-AC32-F4-3](#) [SZ5-M1-WW-C8-V1/V3-FA](#) [BXRC-27E2000-D-73](#) [BXRC-27G2000-D-73](#) [BXRC-30E1000-D-73](#) [BXRC-30G2000-D-73](#) [BXRC-40E1000-D-73](#) [BXRE-30G2000-B-73](#) [BXRE-30G2000-C-73](#) [BXRE-50C2001-C-74](#) [CXM-22-27-80-54-AC30-F4-3](#) [XHP50B-00-0000-0D0UH245G](#) [XHP50B-00-0000-0D0UH240G](#) [XHP50B-00-0000-0D0UG227H](#) [XHP50B-00-0000-0D0HJ245G](#) [MP-5050-8100-27-80](#) [MP-5050-6100-65-80](#) [MP-5050-6100-50-80](#) [MP-5050-6100-40-80](#) [MP-5050-6100-30-80](#) [CXM-22-30-80-54-AC30-F4-3](#) [LTW-2835SZK57](#) [BXEM-50C0000-0-000](#) [WW-WNA30TS-U1\(M1\)](#) [KW CSLPM2.CC-8L8M-4L8N](#) [KW CSLPM2.CC-8L8M-4O9Q](#) [KW DPLS32.SB-6H6J-E5P7-EG-Z264](#) [L1V1-507003V500000](#) [CXM-22-35-80-36-AC10-F3-3](#) [KW3 CGLNM1.TG-Z6QF6-EBVFFCBB46-DFGA](#) [JB5630AWT-H-H65EA0000-NZ000001](#) [XHP50B-00-0000-0D0UG430H](#) [CXM-22-35-90-54-AC40-F5-3](#) [CXM-22-35-80-54-AC40-F5-3](#) [OSM51206E1N-0.8T](#) [OSW43020C1C](#) [MP161611032290](#) [MP-1616-2103-50-90](#) [KW CULPM1.TG-Z6RF7-ebvFfcbB46-65G5](#) [KW DMLS33.SG-Z6M7-EBVFFCBB46-8E8G-700-S](#) [XPGDWT-B1-0000-00EEA](#) [XHP70B-00-0000-0D0BP450E](#) [KW DMLN33.SG-7J7K-EBVFFCBB46-8E8G-200-S](#) [ASMT-MW05-NMNS1](#)