

OEM22 and OEM24L (backlit) 3.5 digit LCD digital voltmeters

features

- 3.5 Digit 12.7mm character height LCD
- 200mV full scale sensitivity
- Automatic zeroing and polarity indication
- Low battery indication (For 9V option only)
- 10 selectable annunciators
- Easy to use decimal point selection
- Display Hold as standard

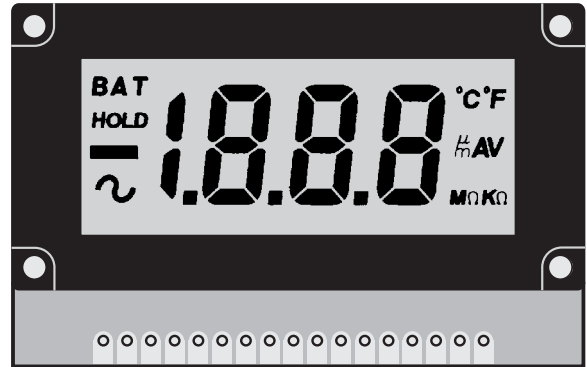

DESCRIPTION

The OEM22 is a neat "flat pack" voltmeter module that can either be sub-panel mounted or used with the optional MB11 fixing bezel. The module is set up for 9 volt operation but can be adjusted for 5V use. A low BAT annunciator is provided as standard (9V only). The OEM24L version comes complete with a green LED backlight. All versions now come with display hold feature.

DIMENSIONS

mm

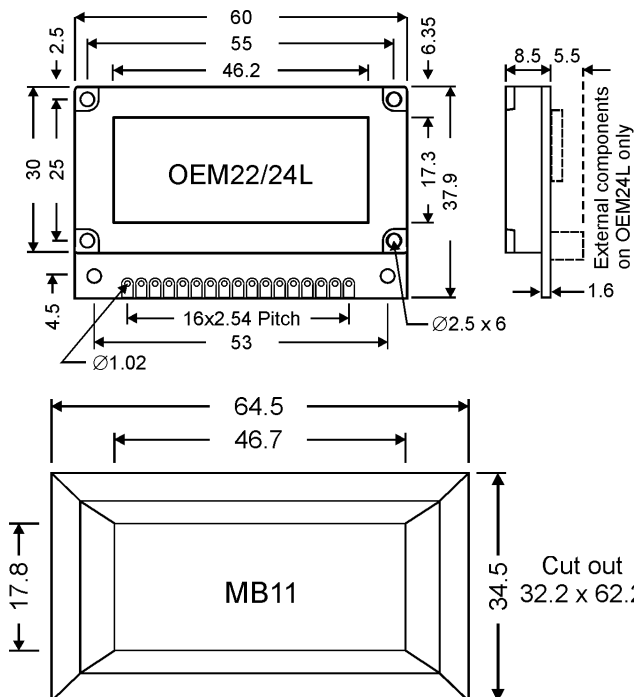

ELECTRICAL CHARACTERISTICS T_A = 25°C

CHARACTERISTIC	CONDITION	MIN	TYP	MAX	UNITS
Supply voltage (VDD)	9 volts	7	9	10	Volts
	5 volts	4.8	5	6	Volts
Supply Current (IDD)	9 Volts		500	900	μA
	5 Volts		5		mA
Full scale				199.9	mV
Input impedance		100			MΩ
Ref voltage ROH	9 Volts		100		mV
Overload voltage				20	Volts
Zero I/P Reading			0	±1	Count
Accuracy at FSD	9 volts		±1	±2	Counts
	5 volts		±1	±4	Counts
Resolution			100		μV
CMRR			70		dB
Temp Coefficient			100	150	ppm/°C
Low Battery Ind.	9 Volts only	6.75	7.25	7.75	V
Backlight Volts	OEM24L		5		V
Backlight Current	at 5V	-	40	60	mA

PIN FUNCTIONS

PIN	DESCRIPTION
VDD	Positive supply terminal
VSS	Negative supply terminal for 9 Volt mode only
INHI	Positive input terminal
INLO	Negative input terminal
RFH	Reference input high terminal
RFL	Reference input low terminal
ROH	Reference output high terminal
ROL	Reference output low terminal
HOLD	Con. to VDD for display hold, to TST for normal.
COM	Analogue common
TST	Connect to VDD to test all segments (except annunciators), for a few seconds only. (9V mode) Also negative supply terminal for 5V supply.
XBP	For driving annunciators
BP	LCD back plane.
D1, D2, D3	Decimal point select. The decimal point will energize when these pins are tied to VDD.
AB,B3,E3,G3,	For use with external auto-ranging circuit.
BAT, °C, °F, ~, m, μ, M, Ω, KΩ, V, A, HOLD	Annunciators. See user instructions. BAT is auto turn on. Turn it off in 5V mode by adjusting V2.
LMP +	Backlight positive terminal (+5V DC) OEM24L
LMP -	Backlight negative terminal (0V DC) OEM24L

OPERATING SPECIFICATION

Operating temperature	0 to 50°C
Storage temperature	-20 to 70°C
Operating relative humidity	80%

ORDERING INFORMATION

OEM22	3.5 digit, 200mV LCD Voltmeter
OEM24L	3.5 digit, 200mV LCD Voltmeter with backlight
MB11	Optional mounting bezel

USER INSTRUCTIONS

The OEM22/24L is designed for 9/5V supply. Incorrect supply polarity will destroy the module immediately. It is ready for general use when connected as in figure 1, for 9V supply. For 5V supply, the module must be calibrated before use as follows. Connect as in figure 2, apply 100mV to the inputs, from a calibrated source and adjust VR1 until the display reads 1000.

The input range is 0-200mV. Over-range is indicated by blanking the three least significant digits and displaying a "1" in the most significant digit.

For 9V operation it is recommended to power from a 9V battery. The inputs are intended to float with respect to the supply but if they do not float they must be no closer than 1.5V from either VDD or VSS (VDD-1.5V and VSS+1.5V). See the circuits for non-floating inputs below.

The low BAT voltage can be set adjusting VR2 but it is not recommended to operate with a supply voltage below 7V.

APPLICATION CIRCUITS

DC VOLTAGE MEASUREMENT

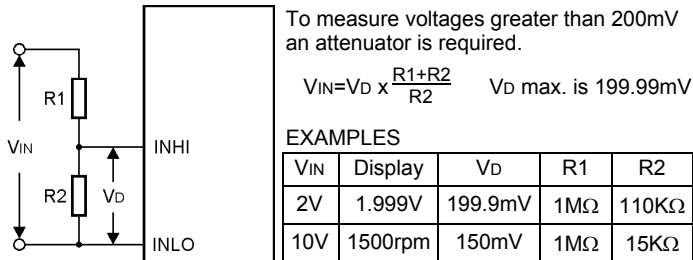

The input impedance becomes R1+R2. Choose accurate stable resistors. Typically, R1=1MΩ. 9MΩ is a practical upper limit.

DC CURRENT MEASUREMENT

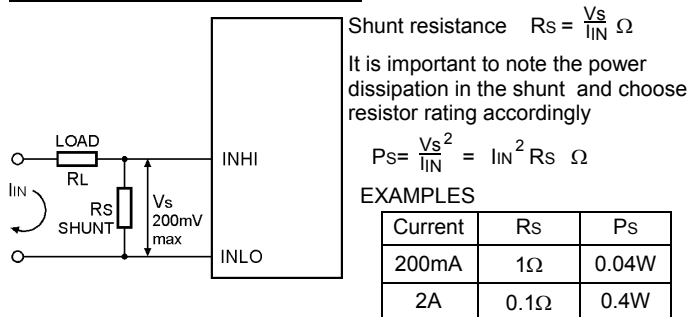

DC VOLTAGE OFFSET

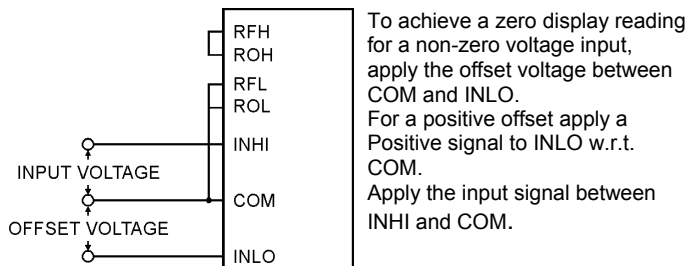

NON FLOATING INPUTS (a)

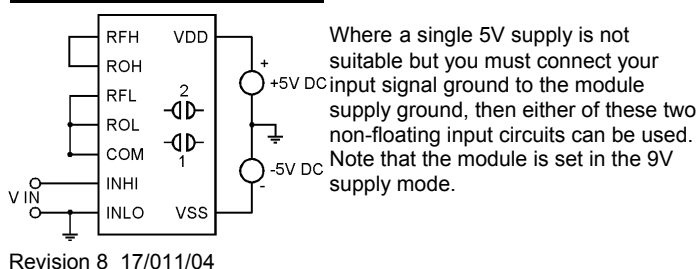

Revision 8 17/01/04

CONNECTION DIAGRAM BASIC CONFIGURATION

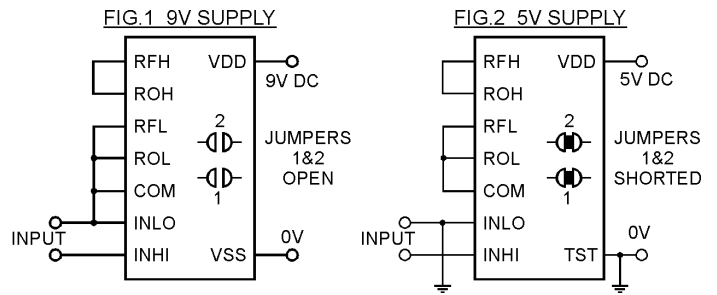

All annunciators are connected to BP for suppression purposes. To light up, cut the trace between the selected annunciator pad and BP track and then link with solder the annunciator pad to the XBP pad next to it.

For 5V operation, INLO must be connected to TST for non-floating inputs (as fig. 2) and to the analogue common pin COM for floating inputs. The low BAT annunciator needs to be turned off by adjusting VR2.

MULTI-RANGE DC VOLTAGE MEASUREMENT

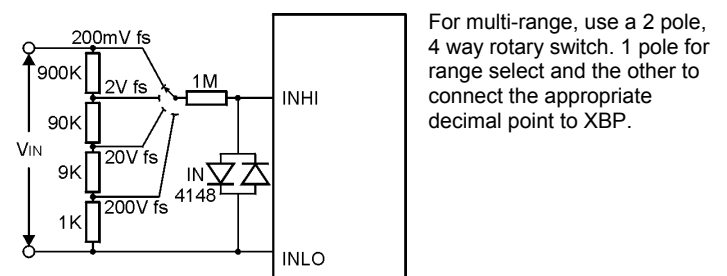

MULTI-RANGE DC CURRENT MEASUREMENT

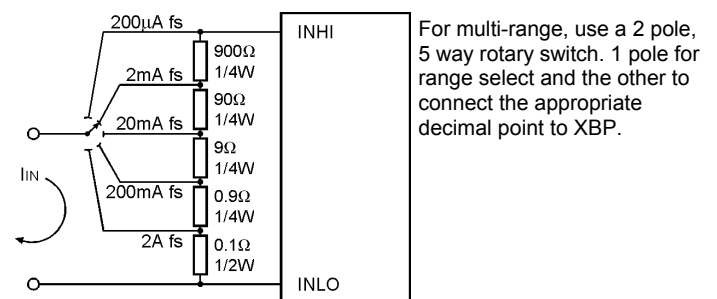

DC VOLTAGE RATIO MEASUREMENT

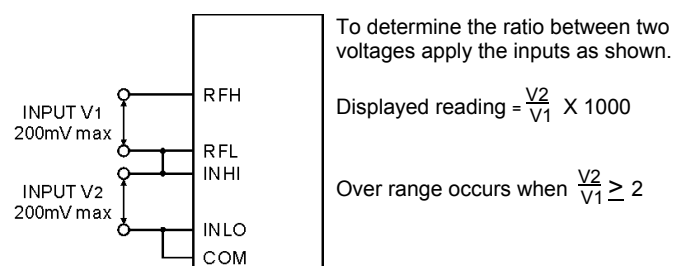

NON FLOATING INPUTS (b)

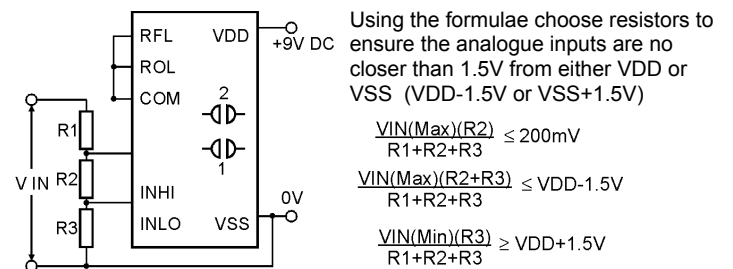

X-ON Electronics

Largest Supplier of Electrical and Electronic Components

Click to view similar products for [anderson power](#) manufacturer:

Other Similar products are found below :

[Anderson Power](#)