

Definition of Terms

Connector according to IEC 61076-4-101

The hardmetric connector system ept-hm 2.0 was developed according to the international standard IEC 61076-4-101. As a result, a worldwide standard for the combination of PCBs is safeguarded by multicontact plug-and-socket connectors for customers.

PCBs can be exchanged without problems from system to system. Important parameters like fixing, shielding and coding remain compatible to all applications.

The spacing

The ept-hm 2.0 connectors have been developed with a spacing of 2 mm between contacts. These connectors are modular and therefore can be stacked together without interrupting the continuity of the 2 mm design. No space is wasted within a row of connectors.

Module stacking

To improve stacking and to avoid accidental reversal of connectors the end of the housings engage the adjacent connector to insure exact positioning onto the PCB board and give the modules the necessary support.

Coding

In order to avoid accidental plug in among PC boards the IEC 61076-4-101 standard provides protection through coding. Coding keys are easily hand inserted into the multifunction block of the connector module A, L and M. The pins are color coded for fast visual recognition.

Multifunction block

The modules A, L, M and compact PCI are equipped with a multifunction block. The coding devices, according to the IEC standard, can be added to the multifunction block. The guides guaranty the correct mating and prohibit accidental reversal of the male and female connectors.

That coding devices may be assembled by a single plug and pulling tool and/or again removed.

Contact length of the rear and front mating area

ept offers 3 different lengths for the front mating area and 4 lengths for the rear mating area for the hm 2.0 male connectors. Different contact lengths are required for signal and ground contacts to establish first make and last break features.

The long contacts with 11,25 mm are predominantly used for the shielding rows z and f.

Thru hole specification of the PCB

Throughplated holes for signal contacts and shieldings in press-fit techniques.

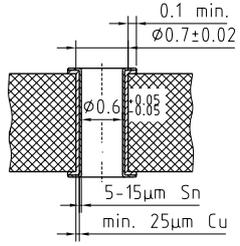
Hole Ø	0,6 mm	
Drillhole	0,68 - 0,72 mm	
Cu	min. 25 µm	
Sn	5 - 15 µm	
Plated through hole	0,55 - 0,65 mm	

Derating Diagram

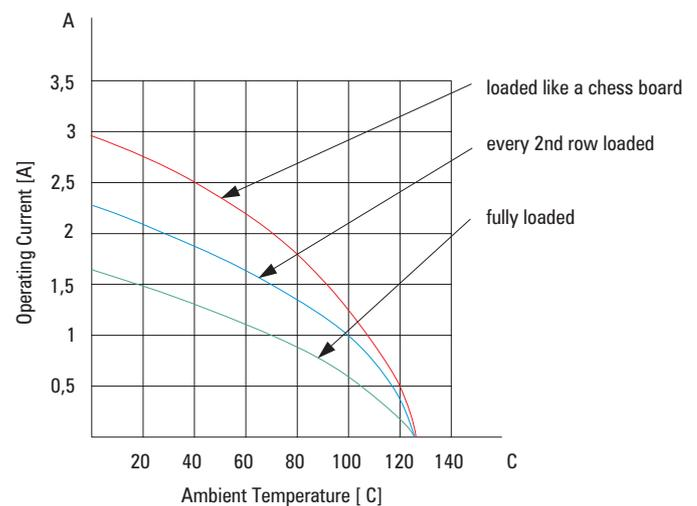

Technical Notes

Electrical and mechanical data

Spacing		2 mm
Temperature range		- 55°C bis +125°C
Mechanical durability		> 250 Mating Cycles
Housing		Polyester Glass filled acc. UL 94V-0
Contact resistance acc. to IEC 512-5		max. 20mΩ
Contact material	Male contact	Bronze
	Female contact	Bronze
Male and female contact surface		Au over PdNi over Ni
Insulation resistance acc. IEC 512-5	Contact/Contact	min. 10 ⁴ MΩ
	Contact/Shield	min. 10 ⁴ MΩ
Insertion force per pin	Contact	max. 0,75 N
	Shield	max. 1 N
Extraction force per pin	Contact	min. 0,15 N
	Shield	min. 0,15 N

Test voltage

		fully loaded	every 2nd position	Chessboard
Row a, c, e Row b, d	within row	750 V _{eff}	1500 V _{eff}	--
	between rows	1500 V _{eff}	1500 V _{eff}	--
Row a, b, c Row a, b, c, d Row a, b, c, d, e	within row	750 V _{eff}	1500 V _{eff}	1500 V _{eff}
	between rows	750 V _{eff}	750 V _{eff}	1200 V _{eff}

Creepage- and air gaps

		fully loaded		every 2nd position		Chessboard	
		Male connector	Modules Female connector	Backplane Male connector	Modules Female connector	Backplane Male connector	Modules Female connector
Row a, c, e Row b, d	within row	0,8 mm	0,6 mm	2,5 mm	2,5 mm	--	--
	between rows	2,5 mm	2,5 mm	2,5 mm	2,5 mm	--	--
Row a, b, c Row a, b, c, d Row a, b, c, d, e	within row	0,8 mm	0,6 mm	2,5 mm	2,5 mm	2,5 mm	2,5 mm
	between rows	0,8 mm	0,6 mm	0,8 mm	0,6 mm	1,5 mm	1,2 mm

Electrical Characteristics

The connector system ept hm 2.0 was specially designed for high data rates. Below are a few examples of the HF characteristics.

A spice model is available for simulations during system design. The simulation model was verified with TDR measurements.

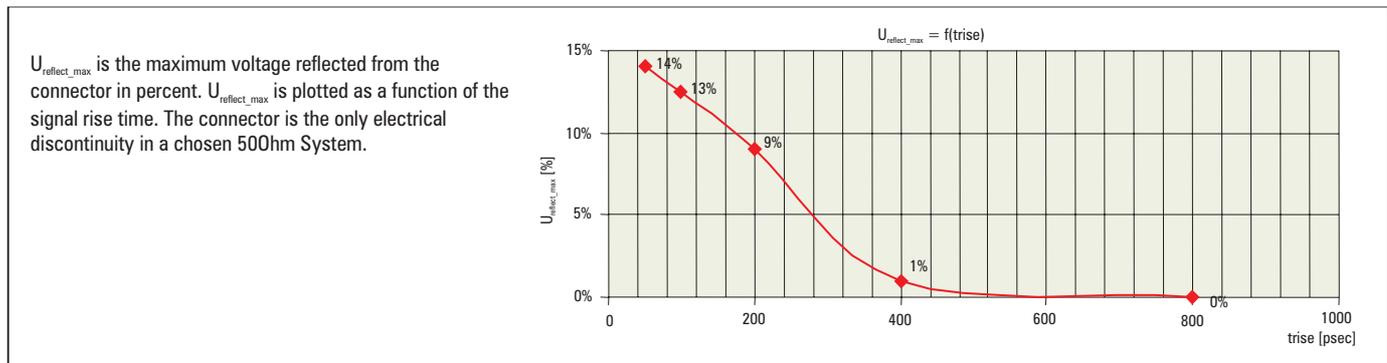
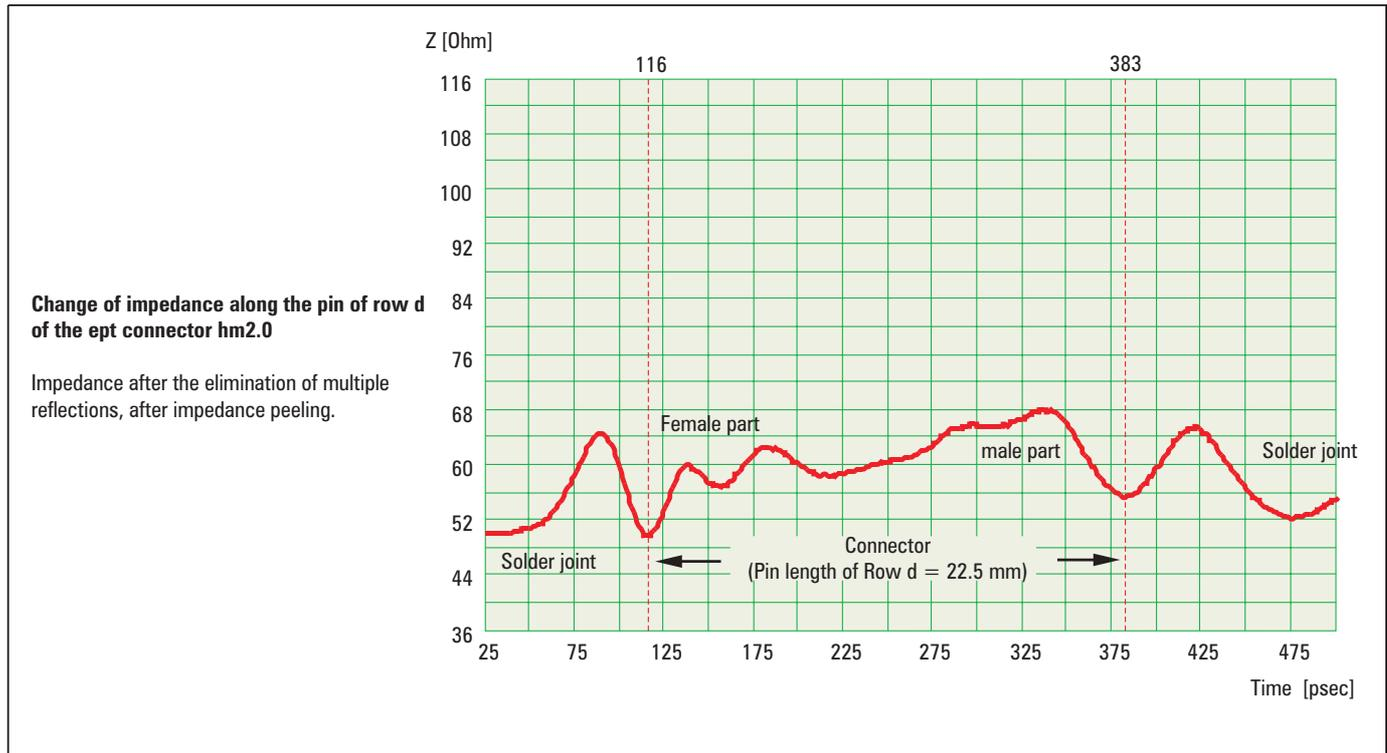

Coupling (Cross talk)

The near end and far end coupling was measured and simulated for different arrangements. A 200 mV signal with a rise time of 25 psec was used.

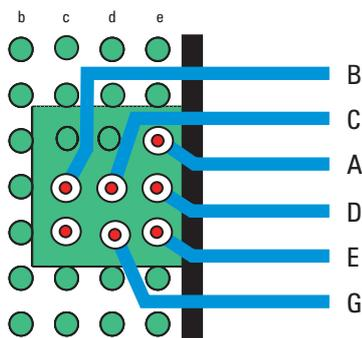
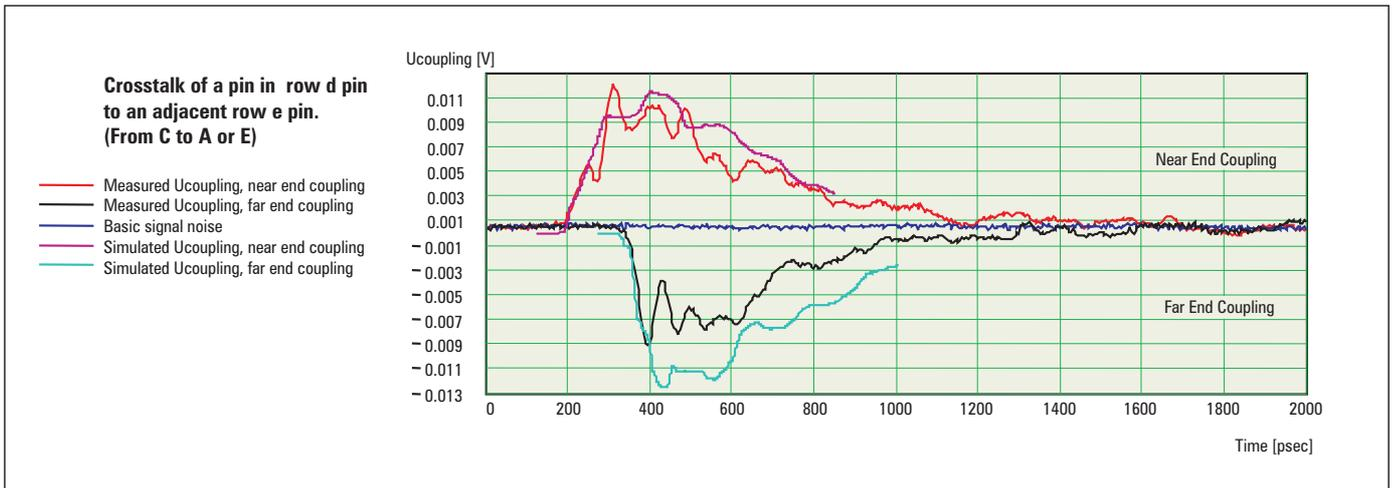
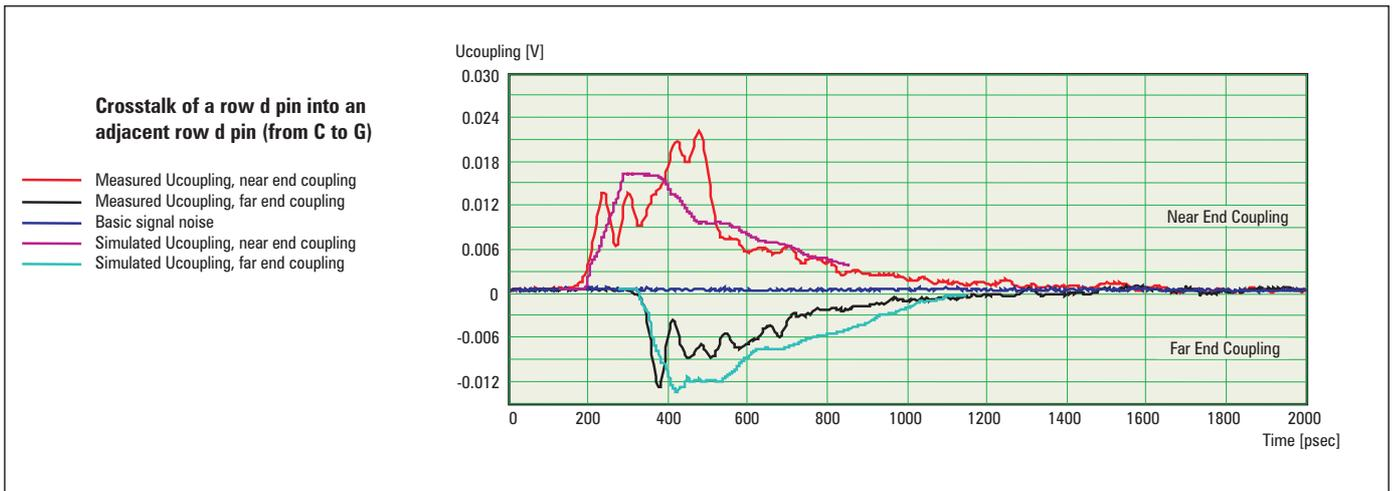

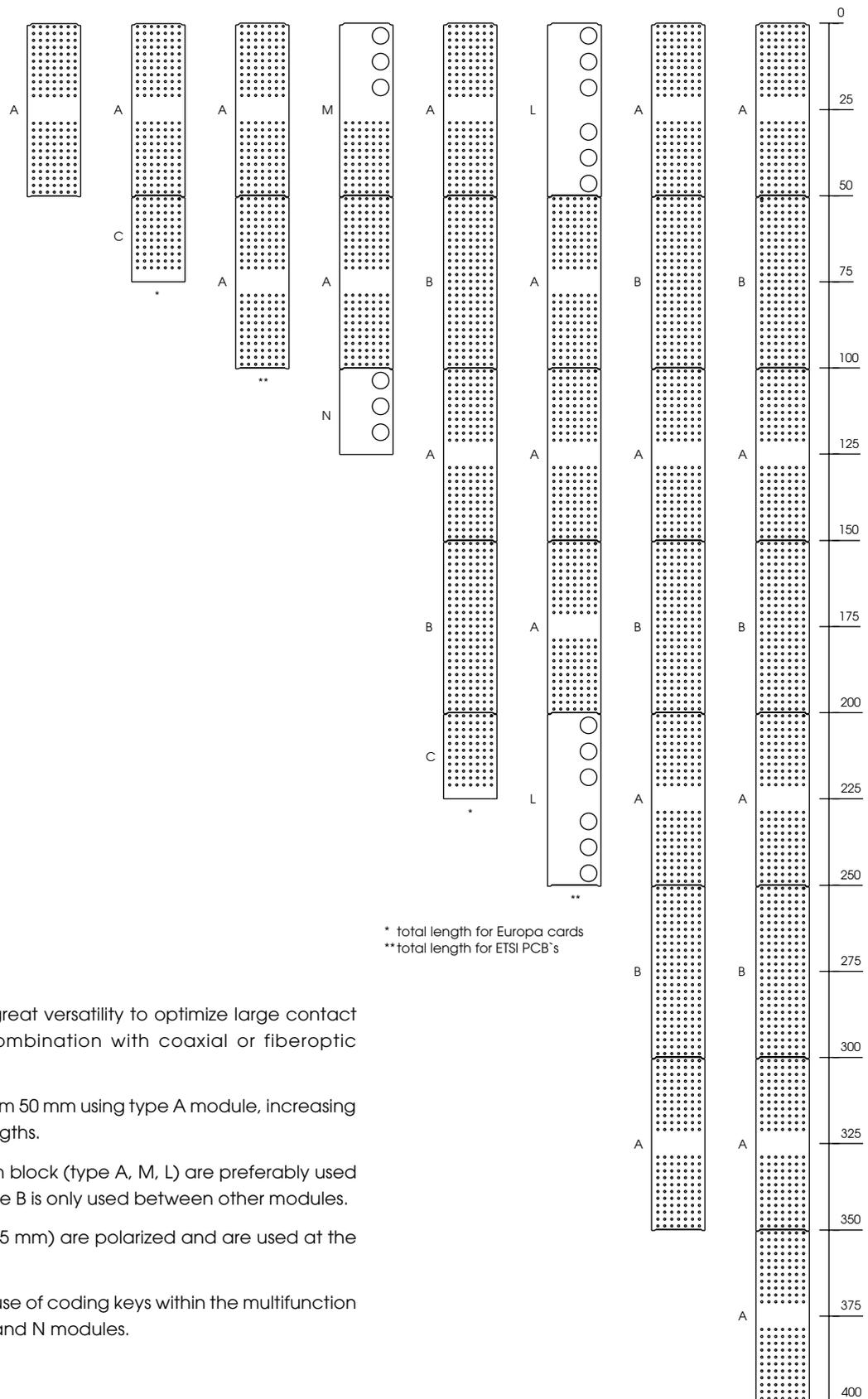

* total length for Europa cards
** total length for ETSI PCB's

System modularity

ept-hm 2.0 modules offer a great versatility to optimize large contact densities. Especially the combination with coaxial or fiberoptic connections.

Stacking can be arranged from 50 mm using type A module, increasing in 25 mm steps to required lengths.

Connectors with multifunction block (type A, M, L) are preferably used at the top of any column. Type B is only used between other modules.

The modules type C and N (25 mm) are polarized and are used at the bottom end of the columns.

Correct mating is assured by use of coding keys within the multifunction block and by use of type C and N modules.

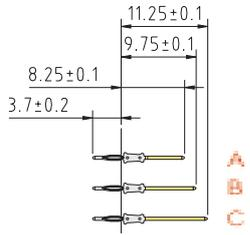
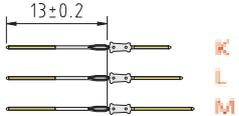
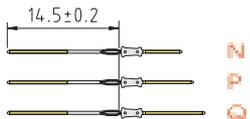
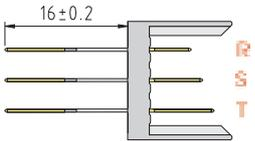
Dimensions of Contacts	Contact	Options	Front mating	Used for
	A	without mating area	8,25-0,1	signal contact
	B		9,75-0,1	signal contact
	C		11,25-0,1	shielding
	K	with mating area 13 mm	8,25-0,1	signal contact
	L		9,75-0,1	signal contact
	M		11,25-0,1	shielding
	N	with mating area 14,5 mm	8,25-0,1	signal contact
	P		9,75-0,1	signal contact
	Q		11,25-0,1	shielding
	R	with mating area 16 mm	8,25-0,1	signal contact
	S		9,75-0,1	signal contact
	T		11,25-0,1	shielding



Male Connectors Type A

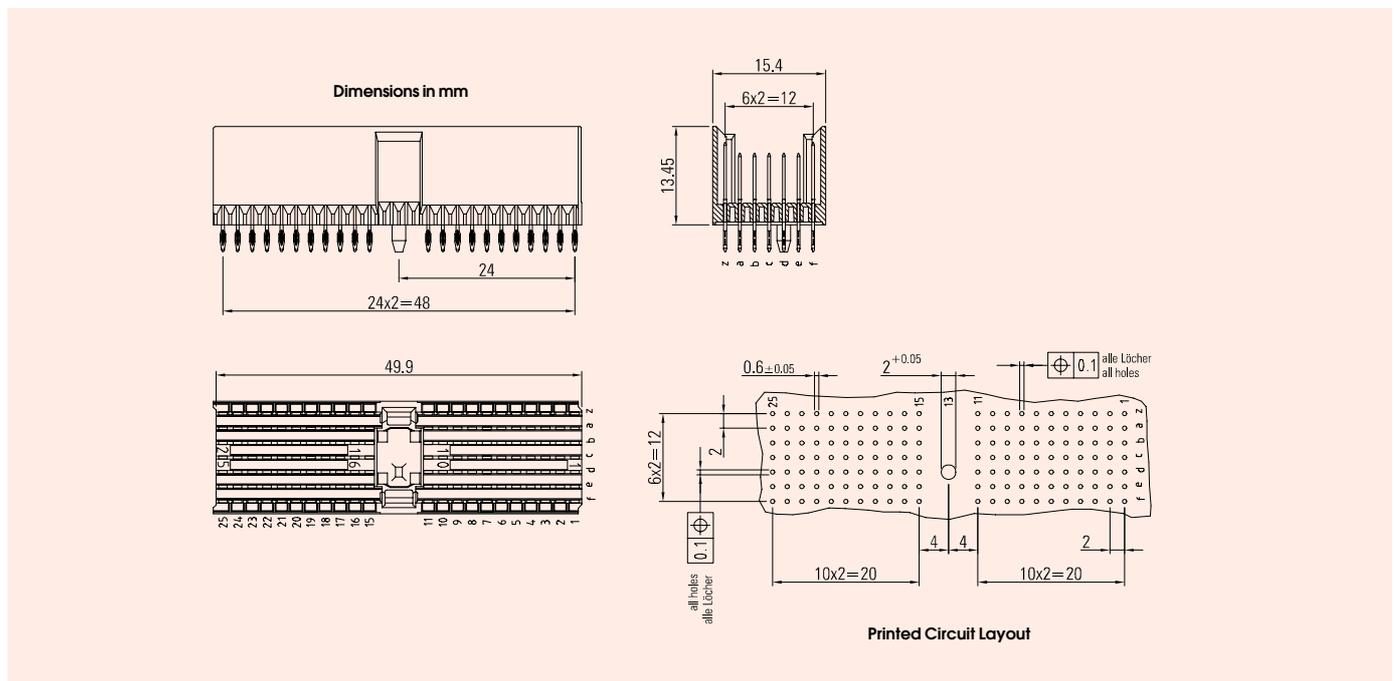

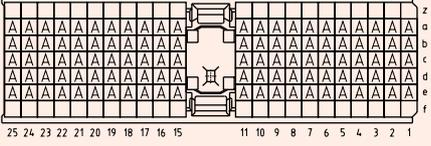
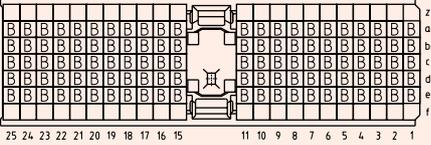
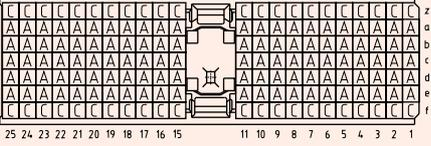
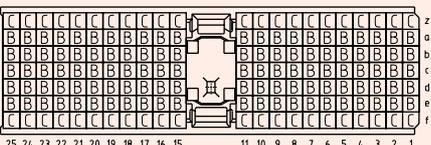
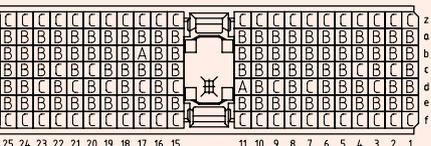
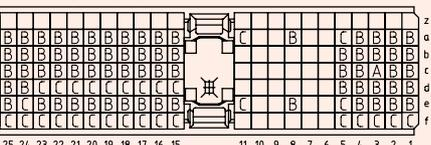
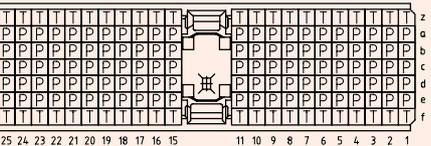
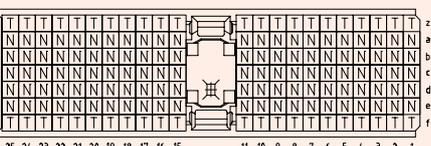
Assembly Drawing	No. of Positions	Row	Type	Pin length	Part Numbers
	110	z a b c d e f	- A A A A A -	-/ 8,25/3,7 8,25/3,7 8,25/3,7 8,25/3,7 8,25/3,7 -/-	243-11010-15
	110	z a b c d e f	- B B B B B -	-/ 9,75/3,7 9,75/3,7 9,75/3,7 9,75/3,7 9,75/3,7 -/-	243-11020-15
	154	z a b c d e f	C A A A A A C	11,25/3,7 8,25/3,7 8,25/3,7 8,25/3,7 8,25/3,7 8,25/3,7 11,25/3,7	243-11310-15
	154	z a b c d e f	C B B B B B C	11,25/3,7 9,75/3,7 9,75/3,7 9,75/3,7 9,75/3,7 9,75/3,7 11,25/3,7	243-11320-15
cPCI Hot Swap 	154	z a b c d e f	C B * * * B C	11,25/3,7 9,75/3,7 * * * 9,75/3,7 11,25/3,7	243-11322-15
cPCI Telephony Spec. 	100	z a b c d e f	- * * * * * *	- * * * * * *	243-11323-15
	154	z a b c d e f	T P P P P P T	11,25/16,0 9,75/14,5 9,75/14,5 9,75/14,5 9,75/14,5 9,75/14,5 11,25/16,0	243-11360-15
	154	z a b c d e f	T N N N N N T	11,25/16,0 8,25/14,5 8,25/14,5 8,25/14,5 8,25/14,5 8,25/14,5 11,25/16,0	243-11735-15

* Attention: Please consider the different pin length in the assembly drawing.

Note: PCB thickness 1,6 - 2,8 mm Part No. XXX-XXXX-05

Insertion Tool: Part No. 884-700-W25

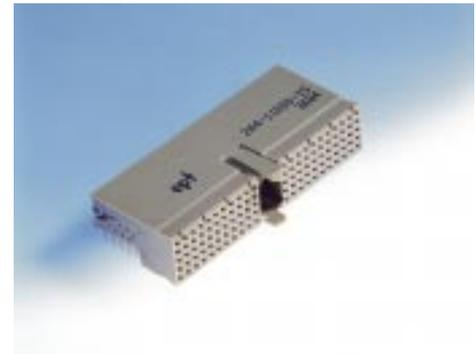

Female Connectors Type A

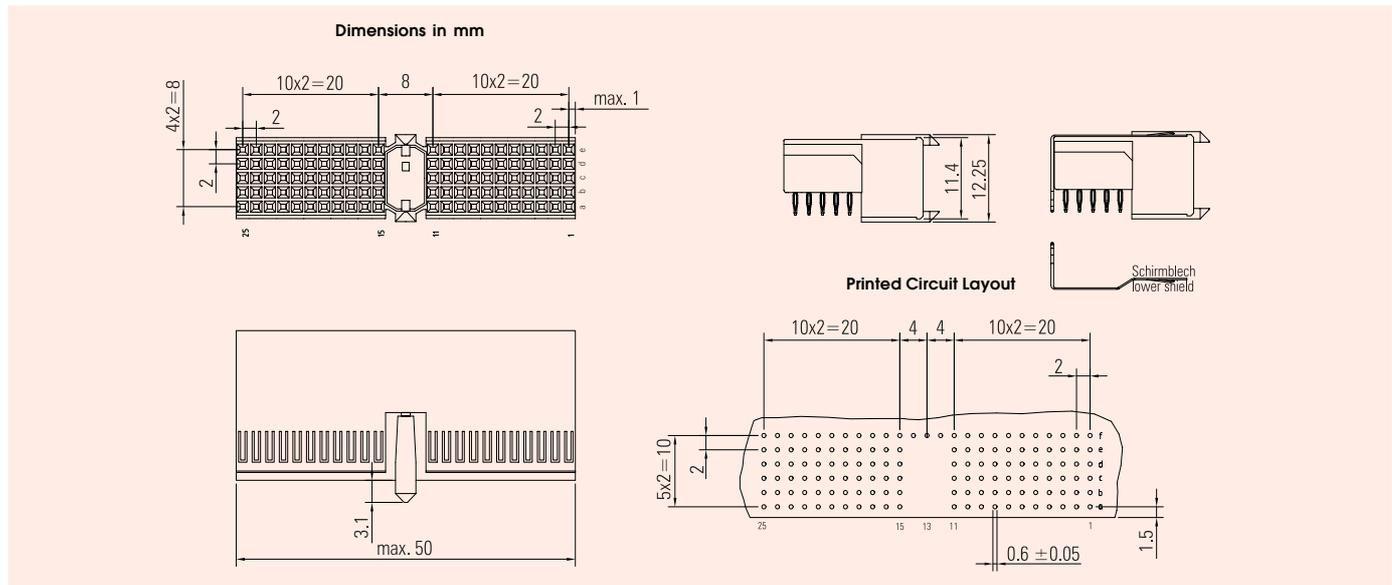

Type	No. of Positions	Quality Class	Part Numbers
connector without shielding	110	I	244-11000-18
		II	244-11000-15
connector with shielding	110	I	244-11300-18
		II	244-11300-15
connector with shielding cPCI Telephony Spec.	90	I	244-11305-18
		II	244-11305-15
lower shield			244-11600-1

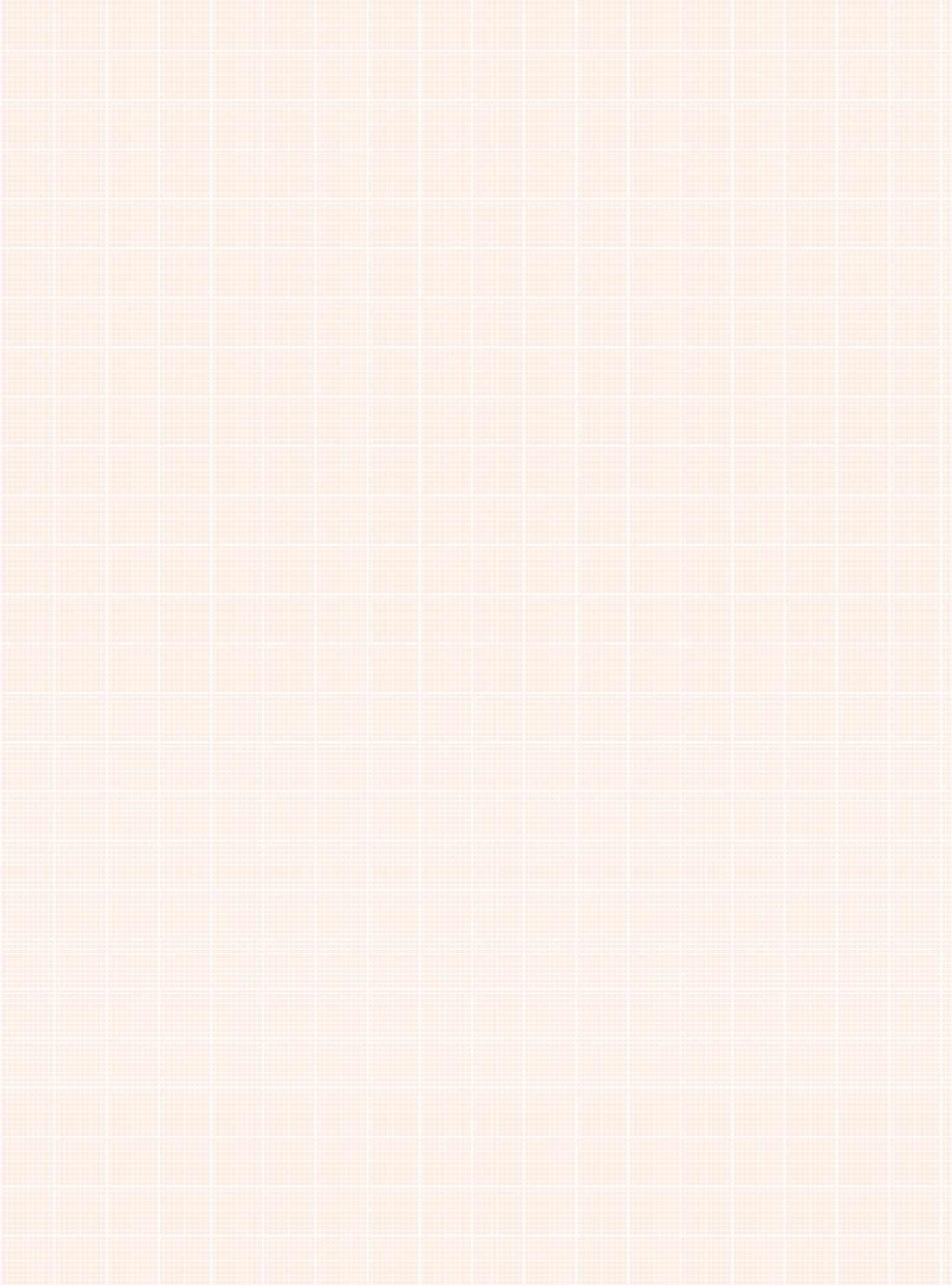



Male Connectors Type B

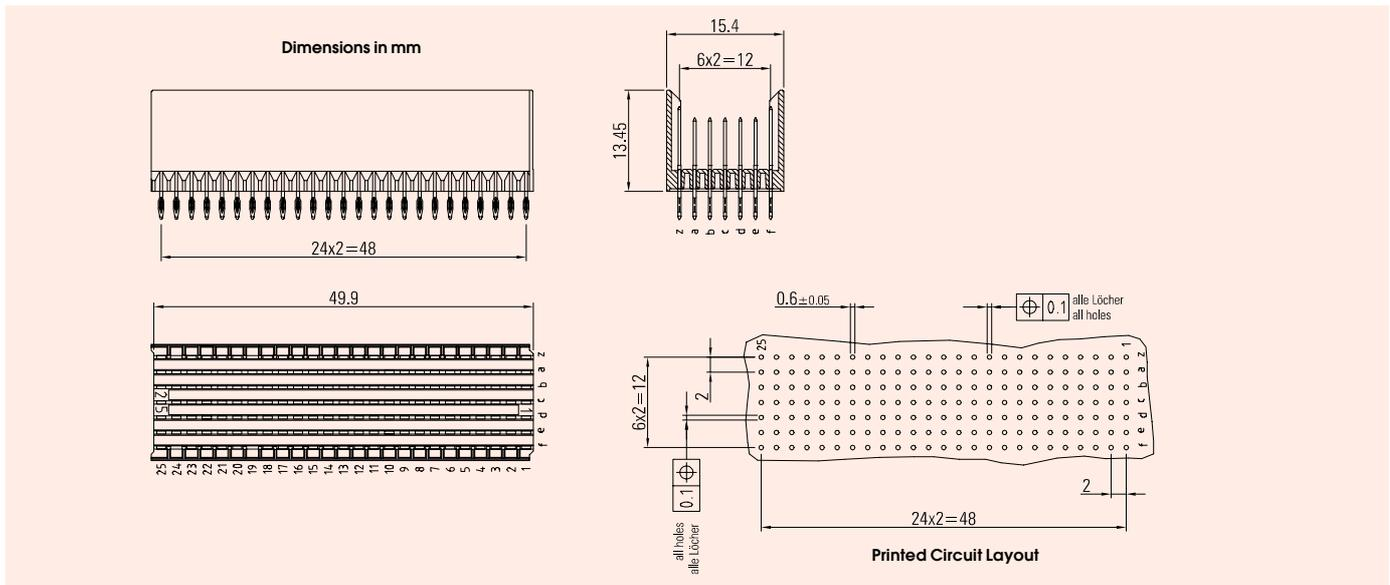

Note: PCB thickness 1,6 - 2,8 mm Part No. XXX-XXXX-05
Insertion Tool: Part No. 884-701-W25

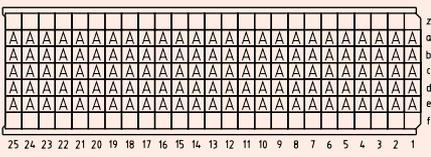
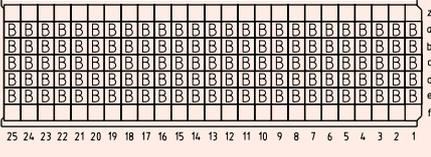
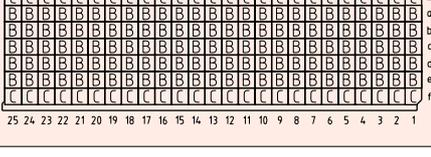
Assembly Drawing	No. of Positions	Row	Type	Pin length	Part Numbers
	125	z a b c d e f	- A A A A A -	-/- 8,25/3,7 8,25/3,7 8,25/3,7 8,25/3,7 8,25/3,7 -/-	243-21010-15
	125	z a b c d e f	- B B B B B -	-/- 9,75/3,7 9,75/3,7 9,75/3,7 9,75/3,7 9,75/3,7 -/-	243-21020-15
	175	z a b c d e f	C A A A A A C	11,25/3,7 8,25/3,7 8,25/3,7 8,25/3,7 8,25/3,7 8,25/3,7 11,25/3,7	243-21310-15
	175	z a b c d e f	C B B B B B C	11,25/3,7 9,75/3,7 9,75/3,7 9,75/3,7 9,75/3,7 9,75/3,7 11,25/3,7	243-21320-15



Female Connectors Type B

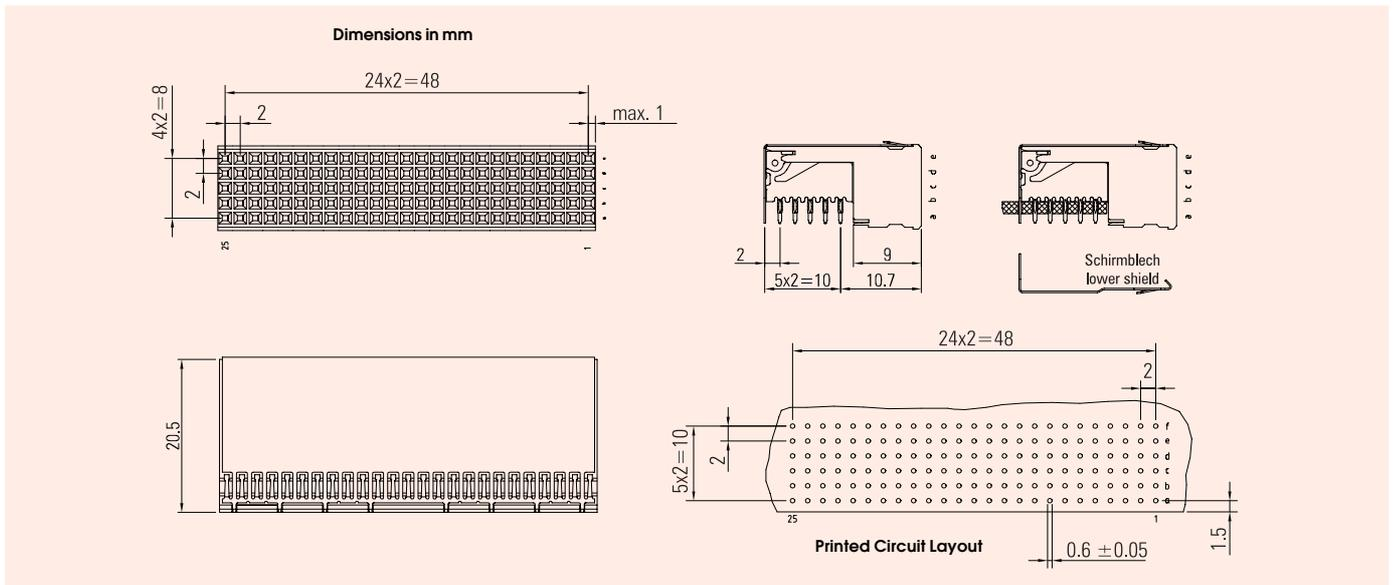

Type	No. of Positions	Part Numbers
without shielding	125	244-21000-15
with shielding	125	244-21300-15
lower shield		244-21600-1



Male Connectors Type B-22 (Compact PCI P2/P5)

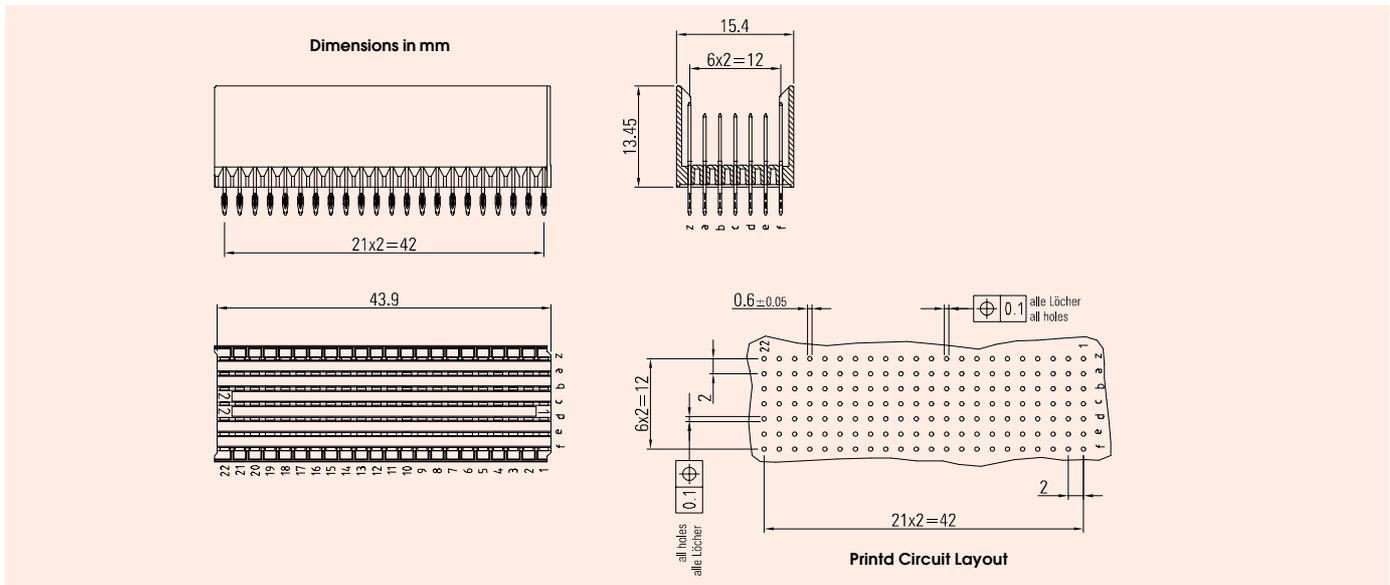

Note: PCB thickness 1,6 - 2,8 mm Part No. XXX-XXXX-05
Insertion Tool: Part No. 884-701-W22

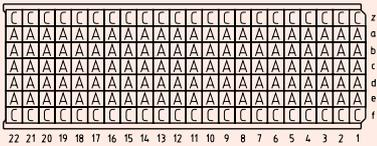
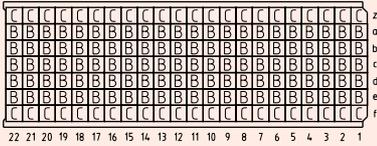
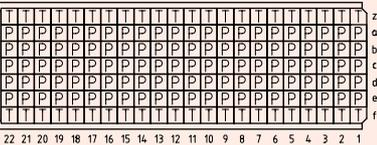
Assembly Drawing	No. of Positions	Row	Type	Pin length	Part Numbers
	154	z a b c d e f	C A A A A A C	11,25/3,7 8,25/3,7 8,25/3,7 8,25/3,7 8,25/3,7 8,25/3,7 11,25/3,7	243-22310-15
cPCI Telephony Spec. 	154	z a b c d e f	* * * * * C	11,25/3,7 * * * * 11,25/3,7	243-22311-15
	154	z a b c d e f	C B B B B B C	11,25/3,7 9,75/3,7 9,75/3,7 9,75/3,7 9,75/3,7 9,75/3,7 11,25/3,7	243-22320-15
	154	z a b c d e f	T P P P P P T	11,25/16,0 9,75/14,5 9,75/14,5 9,75/14,5 9,75/14,5 9,75/14,5 11,25/16,0	243-22360-15



Female Connectors Type B-22 (Compact PCI J2/J5)

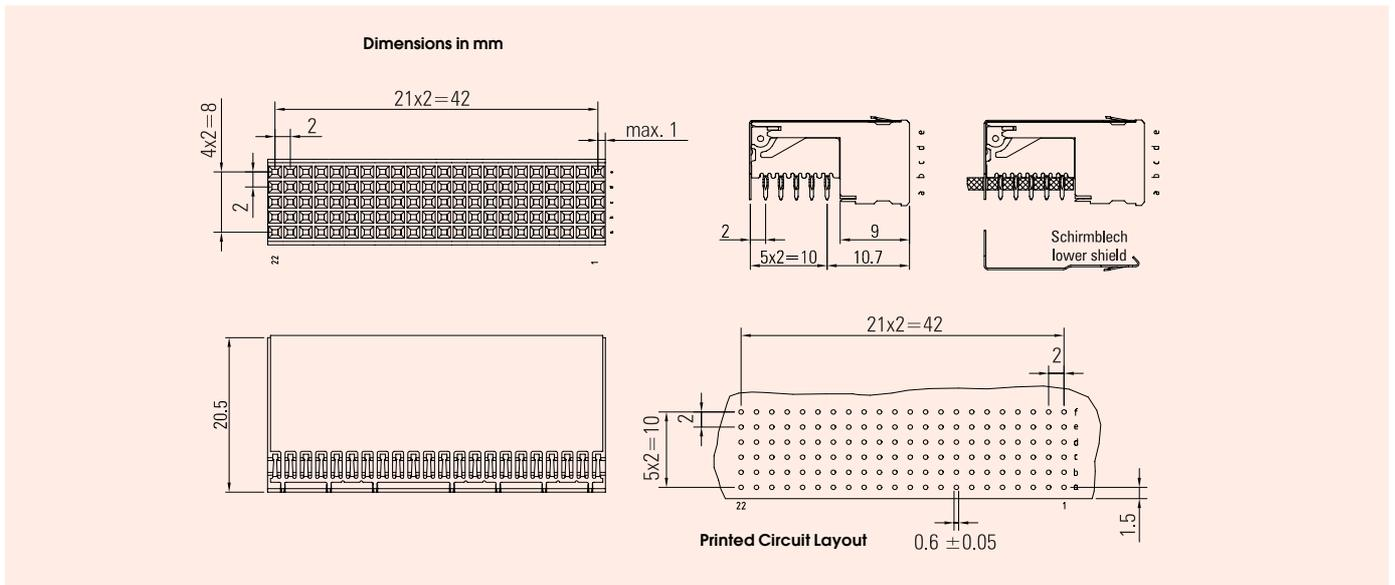

Type	No. of Positions	Part Numbers
without shielding	110	244-22000-15
with shielding	110	244-22300-15
lower shield		244-22600-1

Male Connectors Type B-19 (VME J0 and C-PCI P3)

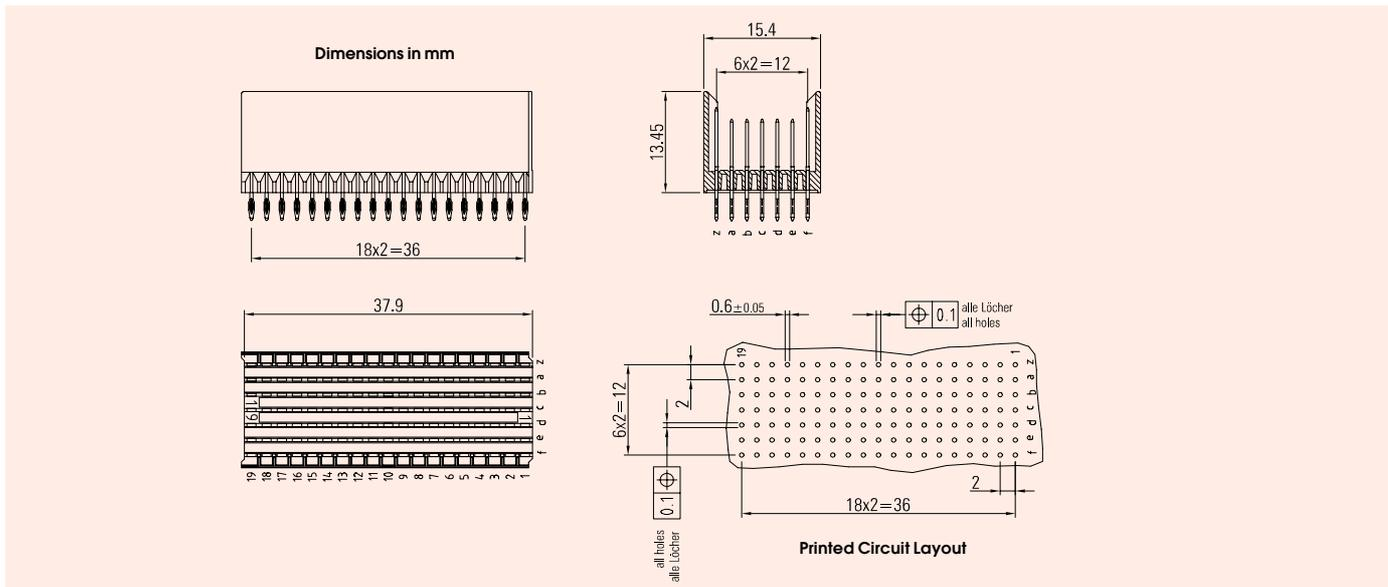

Note: PCB thickness 1,6 - 2,8 mm Part No. XXX-XXXX-05
Insertion Tool: Part No. 884-701-W19

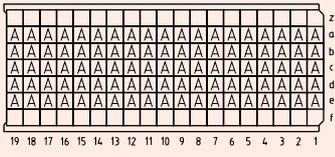
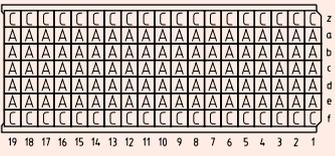
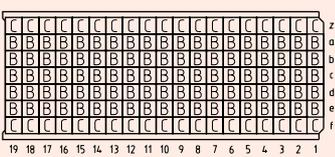
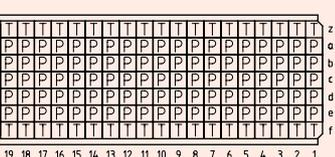
Assembly Drawing	No. of Positions	Row	Type	Pin length	Part Numbers
	95	z a b c d e f	- A A A A A -	-/- 8,25/3,7 8,25/3,7 8,25/3,7 8,25/3,7 8,25/3,7 -/-	243-23010-15
	133	z a b c d e f	C A A A A A C	11,25/3,7 8,25/3,7 8,25/3,7 8,25/3,7 8,25/3,7 8,25/3,7 11,25/3,7	243-23310-15
	133	z a b c d e f	C B B B B B C	11,25/3,7 9,75/3,7 9,75/3,7 9,75/3,7 9,75/3,7 9,75/3,7 11,25/3,7	243-23320-15
	133	z a b c d e f	T P P P P P T	11,25/16,0 9,75/14,5 9,75/14,5 9,75/14,5 9,75/14,5 9,75/14,5 11,25/16,0	243-23360-15

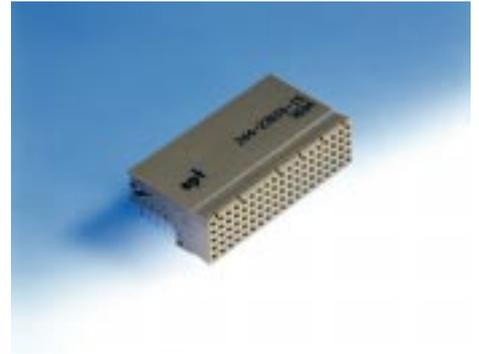

Female Connectors Type B-19 (VME P0 and C-PCI J3)

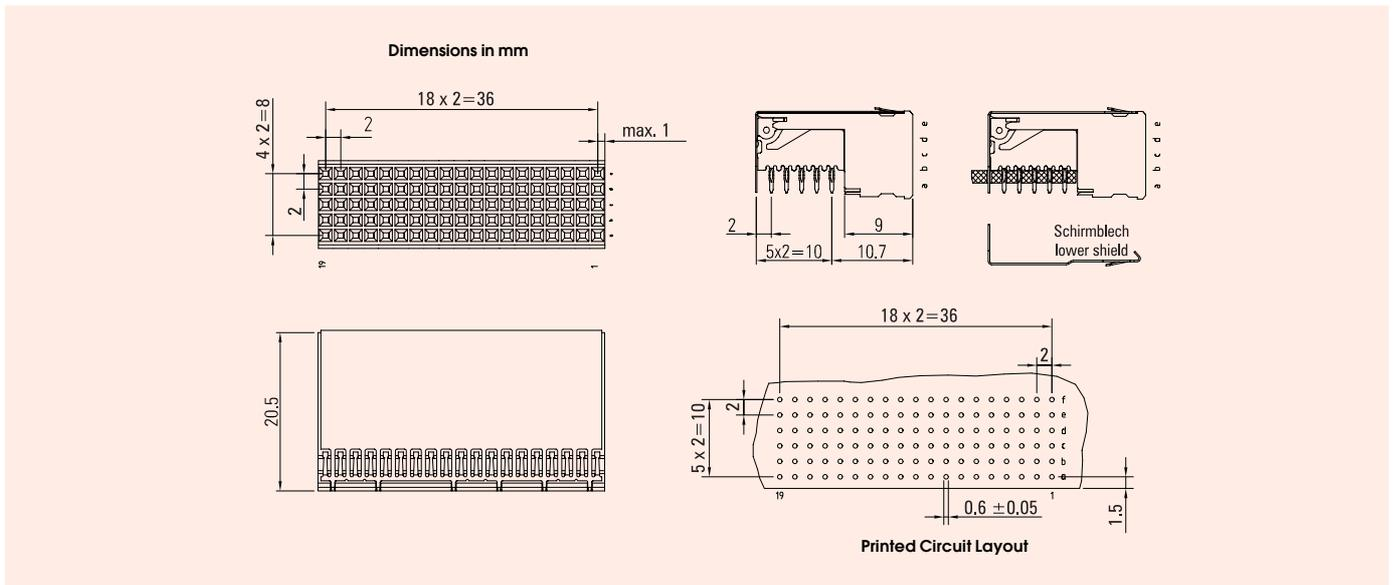

Type	No. of Positions	Part Numbers
without shielding	95	244-23000-15
with shielding	95	244-23300-15
lower shield		244-23600-1

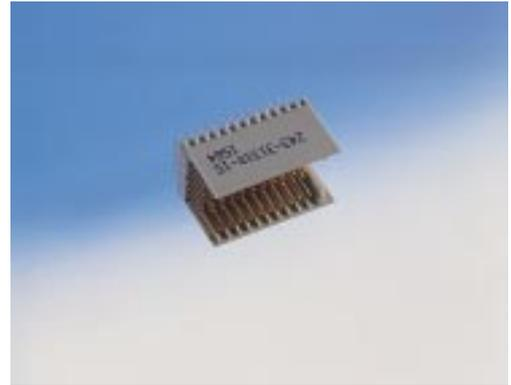

Male Connectors Type C

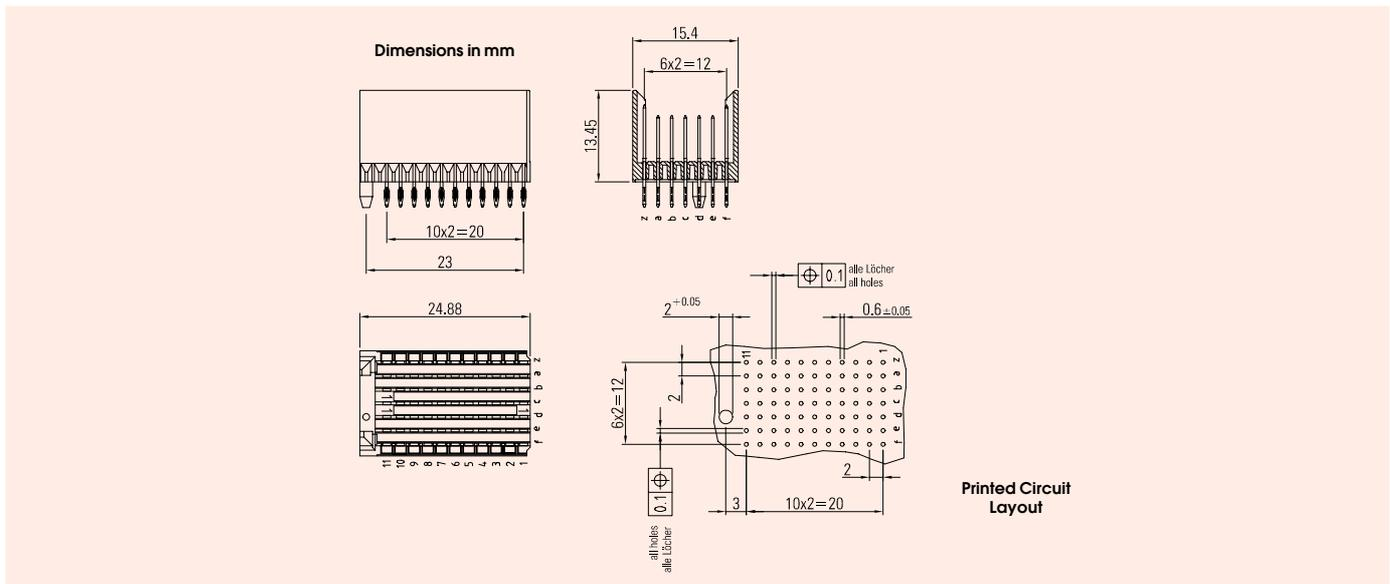

Note: PCB thickness 1,6 - 2,8 mm Part No. XXX-XXXX-05
Insertion Tool: Part No. 884-702-W11

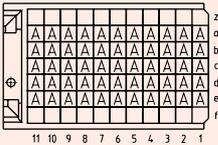
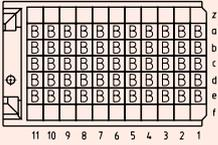
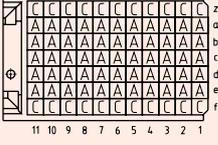
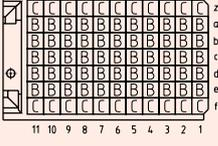
Assembly Drawing	No. of Positions	Row	Type	Pin length	Part Numbers
	55	z a b c d e f	- A A A A A -	-/- 8,25/3,7 8,25/3,7 8,25/3,7 8,25/3,7 8,25/3,7 -/-	243-31010-15
	55	z a b c d e f	- B B B B B -	-/- 9,75/3,7 9,75/3,7 9,75/3,7 9,75/3,7 9,75/3,7 -/-	243-31020-15
	77	z a b c d e f	C A A A A A C	11,25/3,7 8,25/3,7 8,25/3,7 8,25/3,7 8,25/3,7 8,25/3,7 11,25/3,7	243-31310-15
	77	z a b c d e f	C B B B B B C	11,25/3,7 9,75/3,7 9,75/3,7 9,75/3,7 9,75/3,7 9,75/3,7 11,25/3,7	243-31320-15



Female Connectors Type C

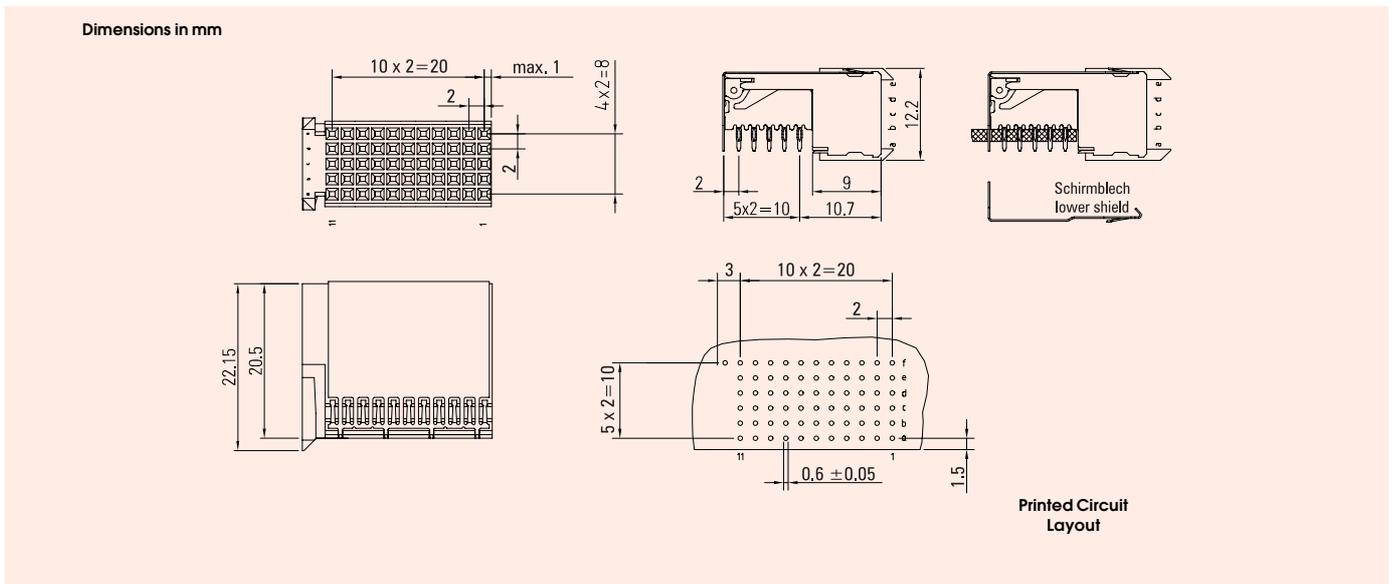

Type	No. of Positions	Part Numbers
without shielding	55	244-31000-15
with shielding	55	244-31300-15
lower shield		244-31600-1

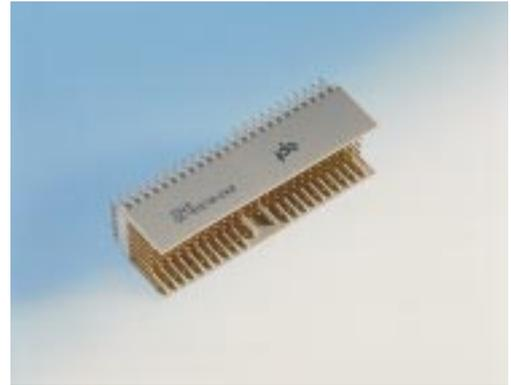

Male Connectors Type AB-25

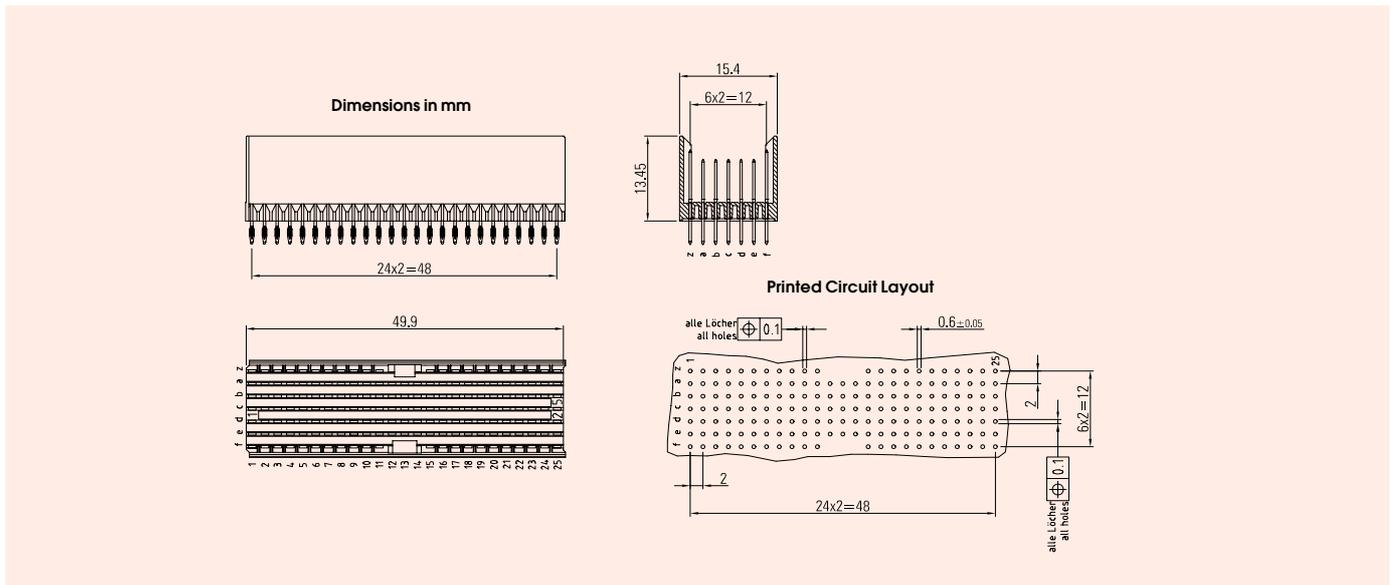

Note: PCB thickness 1,6 - 2,8 mm Part No. XXX-XXXX-05
Insertion Tool: Part No. 884-701-W25

Assembly Drawing	No. of Positions	Row	Type	Pin length	Part Numbers
	125	z a b c d e f	- A A A A A -	-/- 8,25/3,7 8,25/3,7 8,25/3,7 8,25/3,7 8,25/3,7 -/-	243-61010-15
	169	z a b c d e f	C A A A A A C	11,25/3,7 8,25/3,7 8,25/3,7 8,25/3,7 8,25/3,7 8,25/3,7 11,25/3,7	243-61310-15
	169	z a b c d e f	C B B B B B C	11,25/3,7 9,75/3,7 9,75/3,7 9,75/3,7 9,75/3,7 9,75/3,7 11,25/3,7	243-61320-15
	169	z a b c d e f	T P P P P P T	11,25/16,0 9,75/14,5 9,75/14,5 9,75/14,5 9,75/14,5 9,75/14,5 11,25/16,0	243-61360-15



Female Connectors Type AB-25

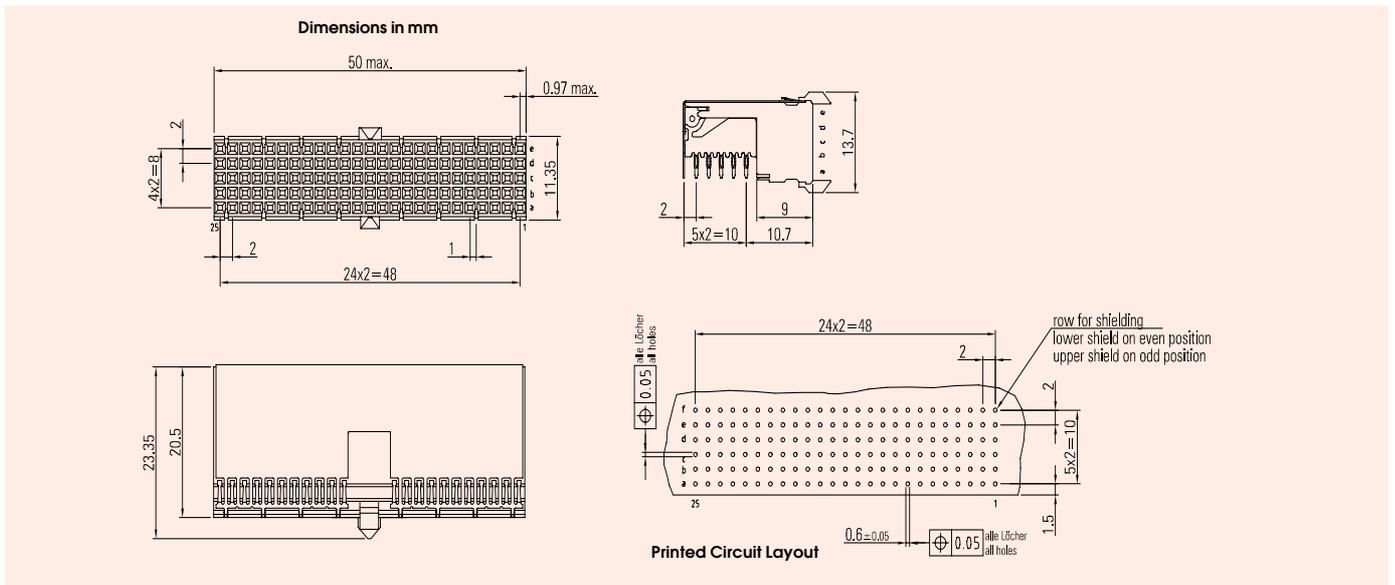

Type	No. of Positions	Part Numbers
connectors without shielding	125	244-61000-15
connectors with shielding	125	244-61300-15
lower shield		244-11600-1

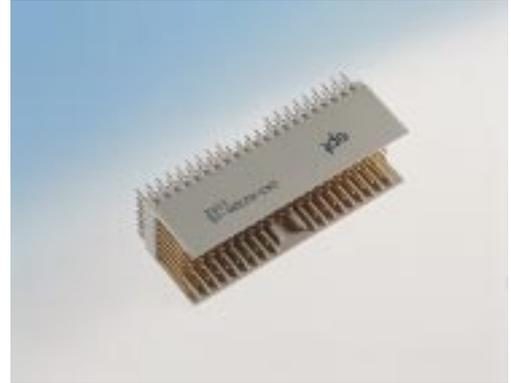

Male Connectors Type AB-22

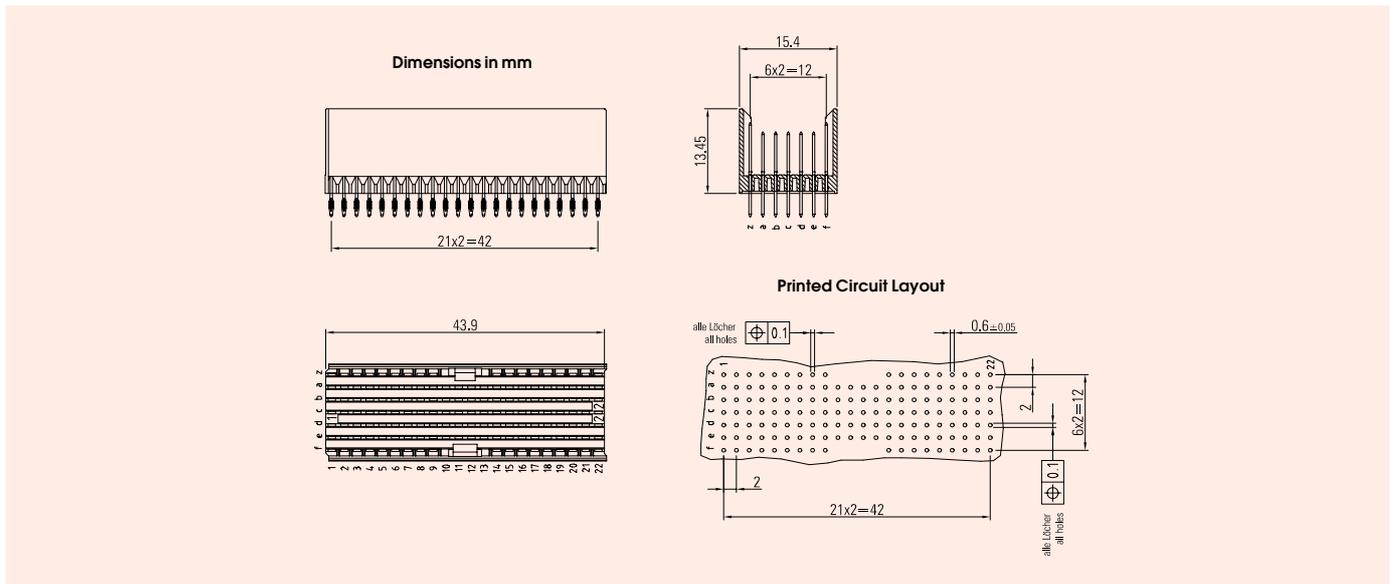

Note: PCB thickness 1,6 - 2,8 mm Part No. XXX-XXXX-05
Insertion Tool: Part No. 884-701-W22

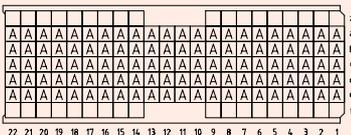
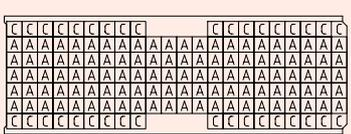
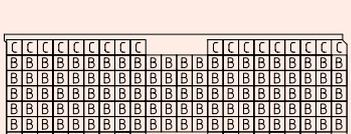
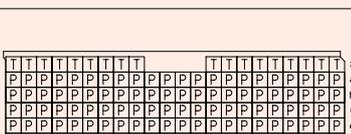
Assembly Drawing	No. of Positions	Row	Type	Pin length	Part Numbers
	110	z a b c d e f	- A A A A A -	-/- 8,25/3,7 8,25/3,7 8,25/3,7 8,25/3,7 8,25/3,7 -/-	243-62010-15
	146	z a b c d e f	C A A A A A C	11,25/3,7 8,25/3,7 8,25/3,7 8,25/3,7 8,25/3,7 8,25/3,7 11,25/3,7	243-62310-15
	146	z a b c d e f	C B B B B B C	11,25/3,7 9,75/3,7 9,75/3,7 9,75/3,7 9,75/3,7 9,75/3,7 11,25/3,7	243-62320-15
	146	z a b c d e f	T P P P P P T	11,25/16,0 9,75/14,5 9,75/14,5 9,75/14,5 9,75/14,5 9,75/14,5 11,25/16,0	243-62360-15



Female Connectors Type AB-22

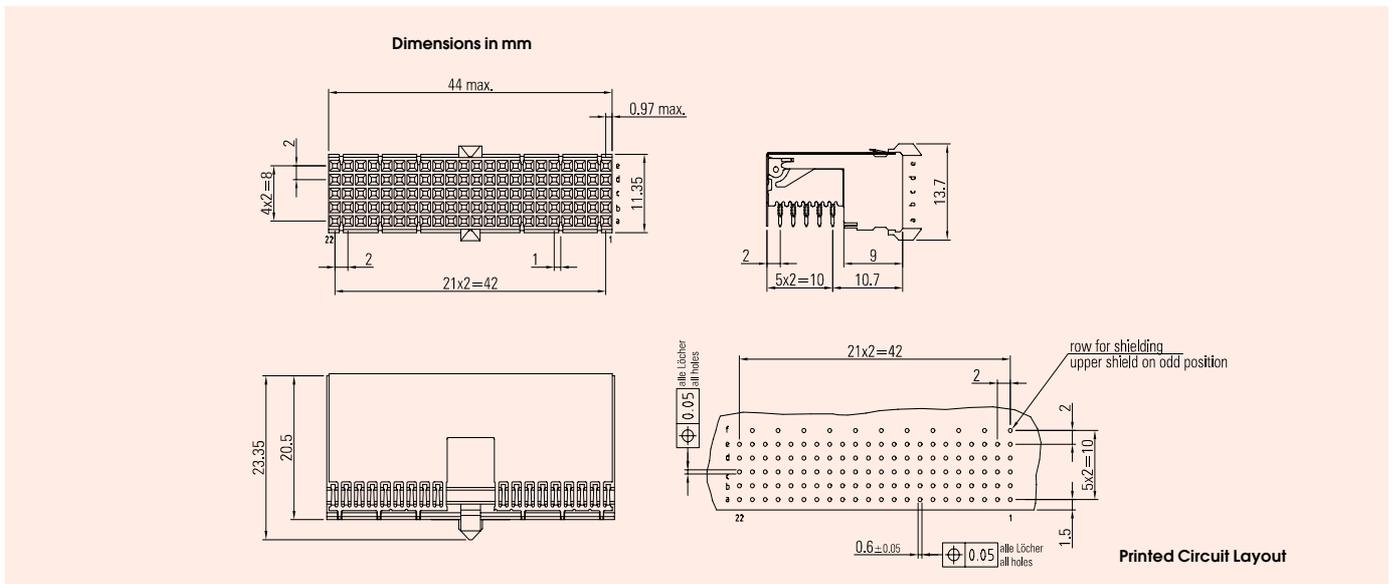

Type	No. of Positions	Part Numbers
connectors without shielding	110	244-62000-15
connectors with shielding	110	244-62300-15



Male Connectors Type AB-19

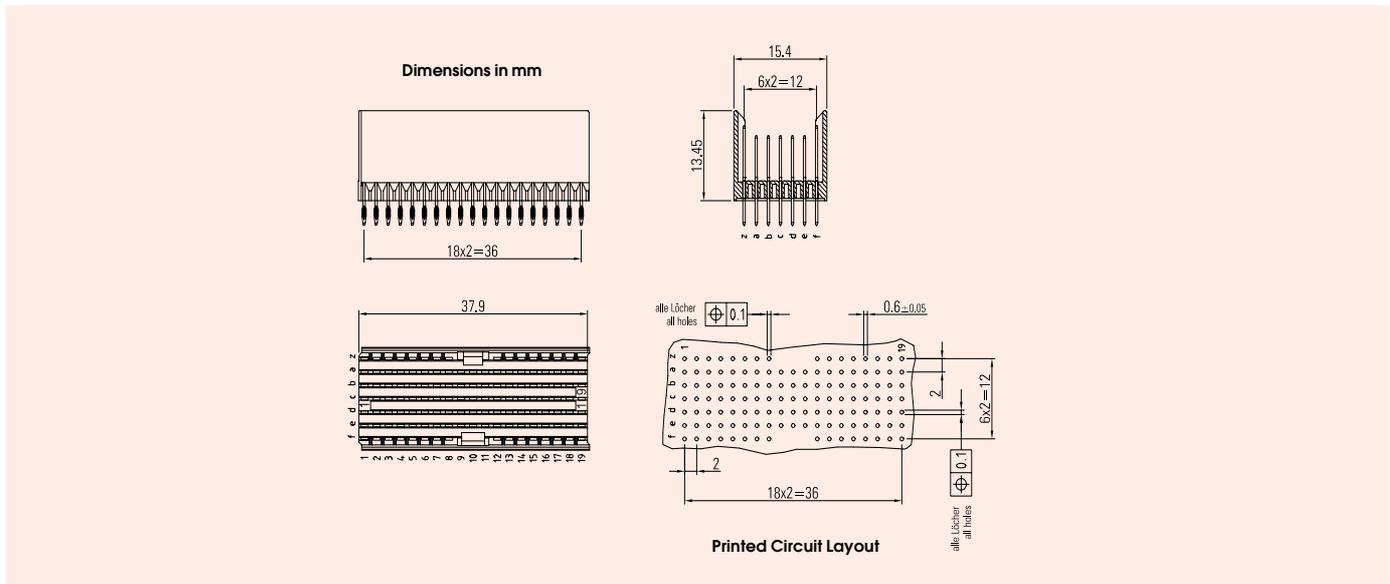

Note: PCB thickness 1,6 - 2,8 mm Part No. XXX-XXXX-05
 Insertion Tool: Part No. 884-701-W19

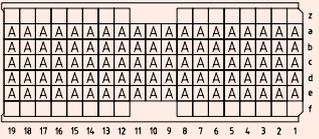
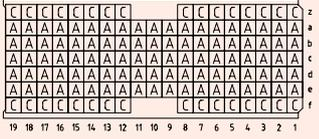
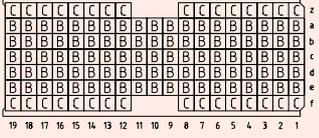
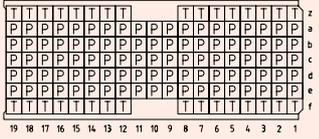
Assembly Drawing	No. of Positions	Row	Type	Pin length	Part Numbers
	95	z a b c d e f	- A A A A A -	-/- 8,25/3,7 8,25/3,7 8,25/3,7 8,25/3,7 8,25/3,7 -/-	243-63010-15
	127	z a b c d e f	C A A A A A C	11,25/3,7 8,25/3,7 8,25/3,7 8,25/3,7 8,25/3,7 8,25/3,7 11,25/3,7	243-63310-15
	127	z a b c d e f	C B B B B B C	11,25/3,7 9,75/3,7 9,75/3,7 9,75/3,7 9,75/3,7 9,75/3,7 11,25/3,7	243-63320-15
	127	z a b c d e f	T P P P P P T	11,25/16,0 9,75/14,5 9,75/14,5 9,75/14,5 9,75/14,5 9,75/14,5 11,25/16,0	243-63360-15



Female Connectors Type AB-19

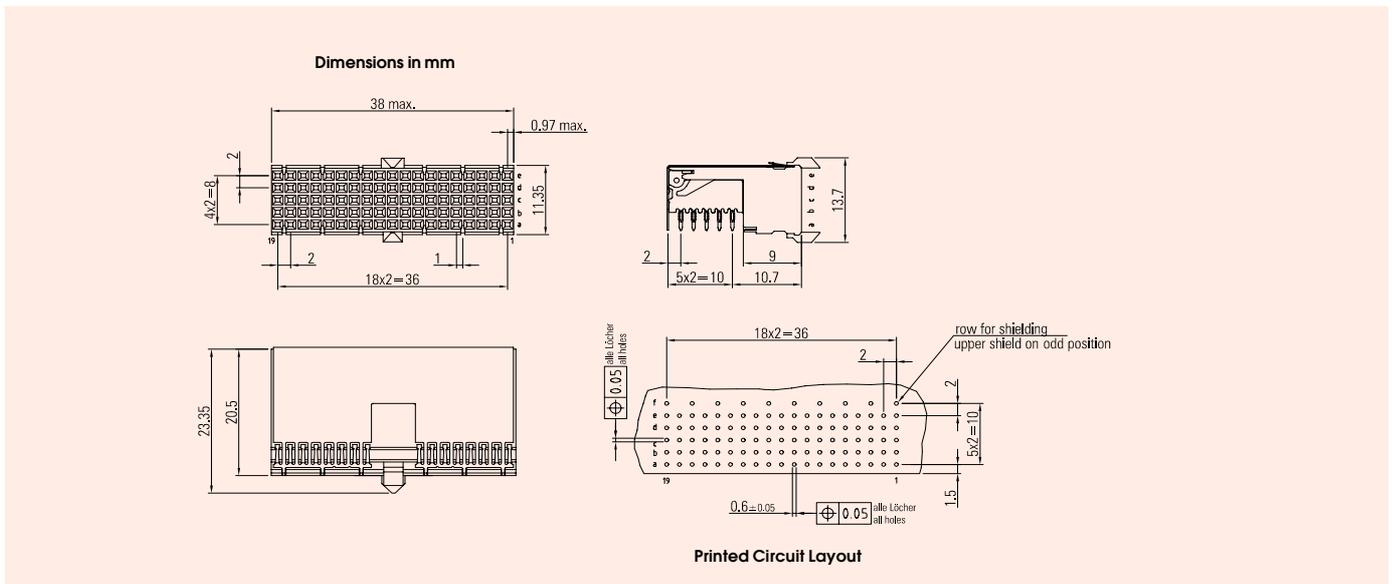

Type	No. of Positions	Part Numbers
connectors without shielding	95	244-63000-15
connectors with shielding	95	244-63300-15



Male Connectors Type Compact PCI (P1+P2/P4+P5)

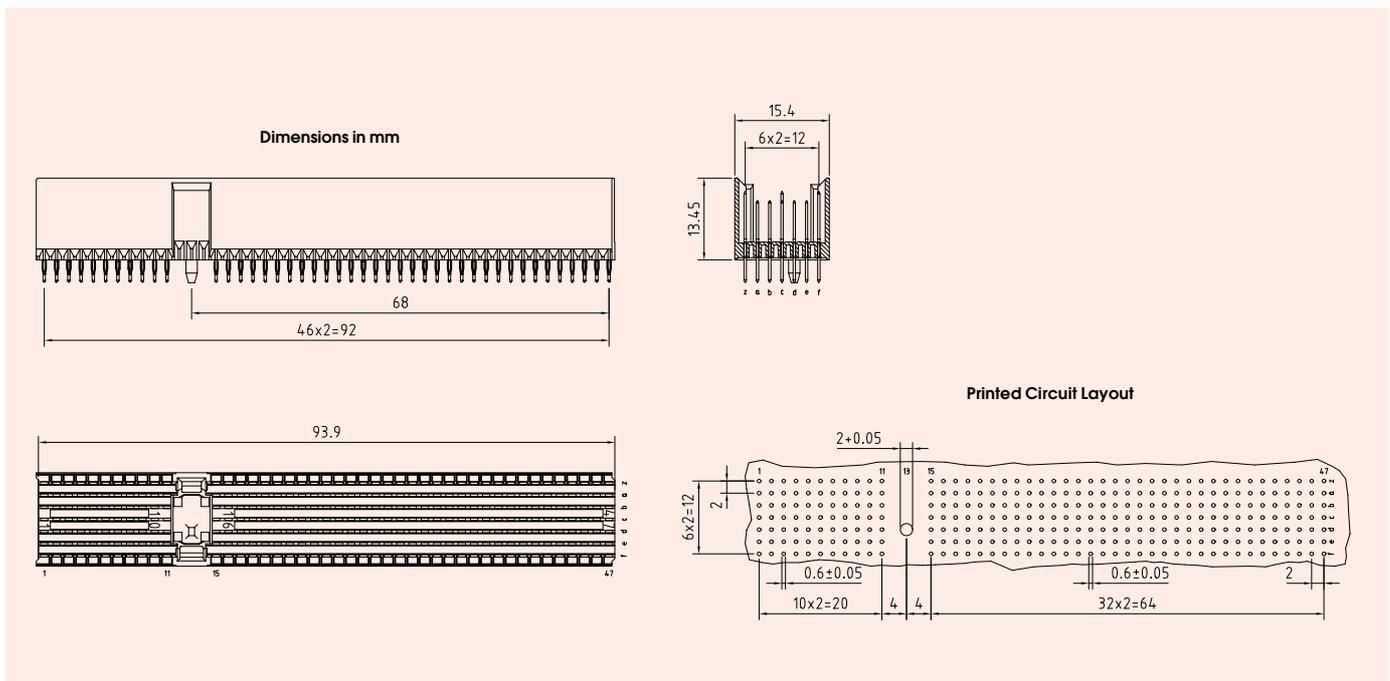

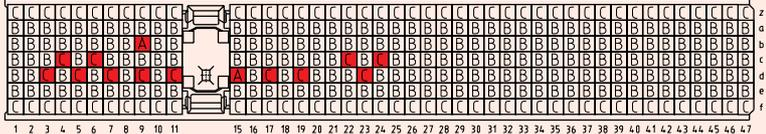
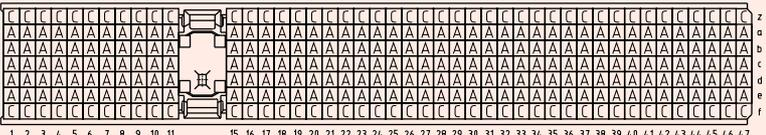
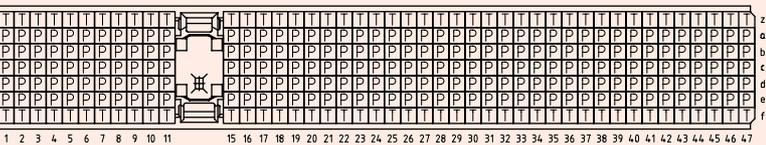
Assembly Drawing	No. of Pos.	Row	Type	Pin length	Part Numbers
	308	z a b c d e f	C B * * * B C	11,25/3,7 9,75/3,7 * /3,7 * /3,7 * /3,7 9,75/3,7 11,25/3,7	243-12322-15
	308	z a b c d e f	C A A A A A C	11,25/3,7 8,25/3,7 8,25/3,7 8,25/3,7 8,25/3,7 8,25/3,7 11,25/3,7	243-12310-15
	308	z a b c d e f	T P P P P P T	11,25/16,0 9,75/14,5 9,75/14,5 9,75/14,5 9,75/14,5 9,75/14,5 11,25/16,0	243-12360-15

* Attention: Please consider the different pin length in the assembly drawing. Is used for Compact PCI

Insertion Tool: Part No. 884-703-W47

On Request: Telephony Spec./Hot Swap

Note: PCB thickness 1,6 - 2,8 mm Part No. XXX-XXXX-05

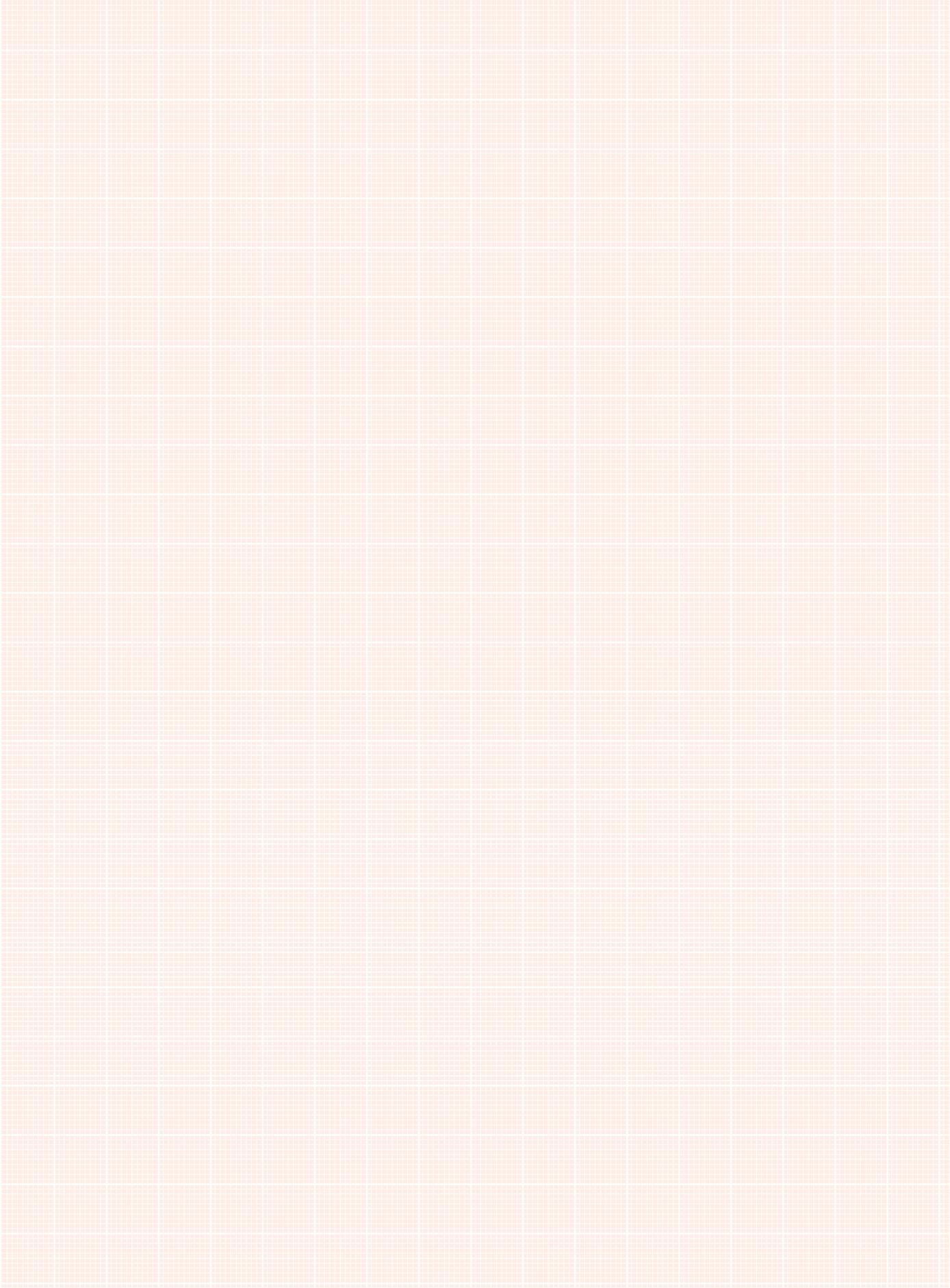

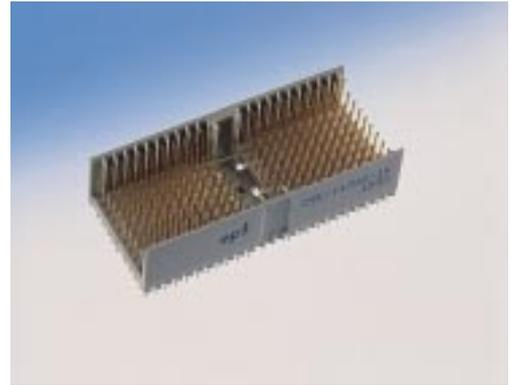

Male Connectors Type D

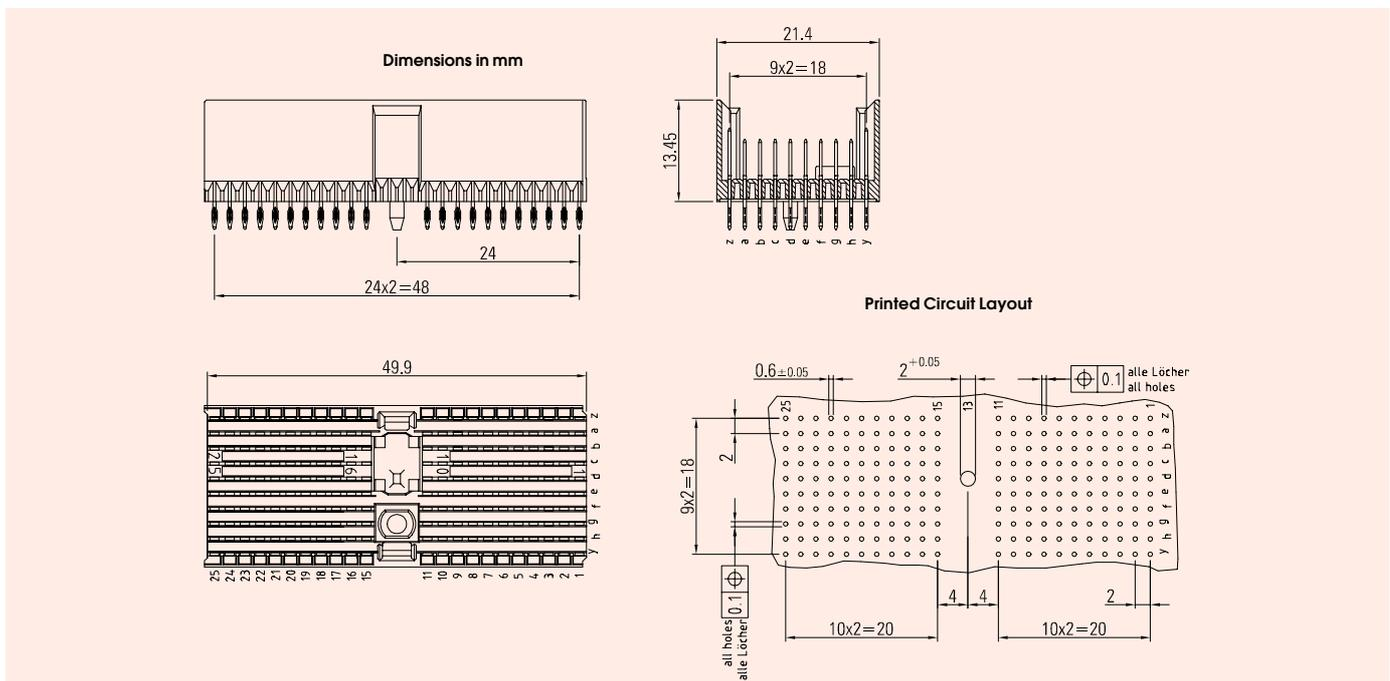

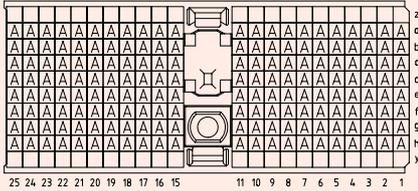
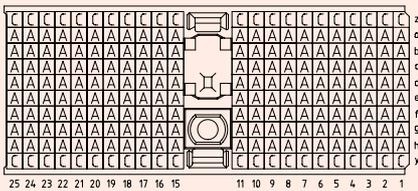
Assembly Drawing	No. of Positions	Row	Type	Pin length	Part Numbers
	176	z a b c d e f g h y	- A A A A A A A A -	-/- 8,25/3,7 8,25/3,7 8,25/3,7 8,25/3,7 8,25/3,7 8,25/3,7 8,25/3,7 -	245-11010-15
	220	z a b c d e f g h y	C A A A A A A A A A C	11,25/3,7 8,75/3,7 8,75/3,7 8,75/3,7 8,75/3,7 8,75/3,7 8,75/3,7 8,75/3,7 8,75/3,7 11,25/3,7	245-11310-15

Note: PCB thickness 1,6 - 2,8 mm Part No. XXX-XXXX-05

Insertion Tool: Part Number 884-710-W25



Female Connectors Type D

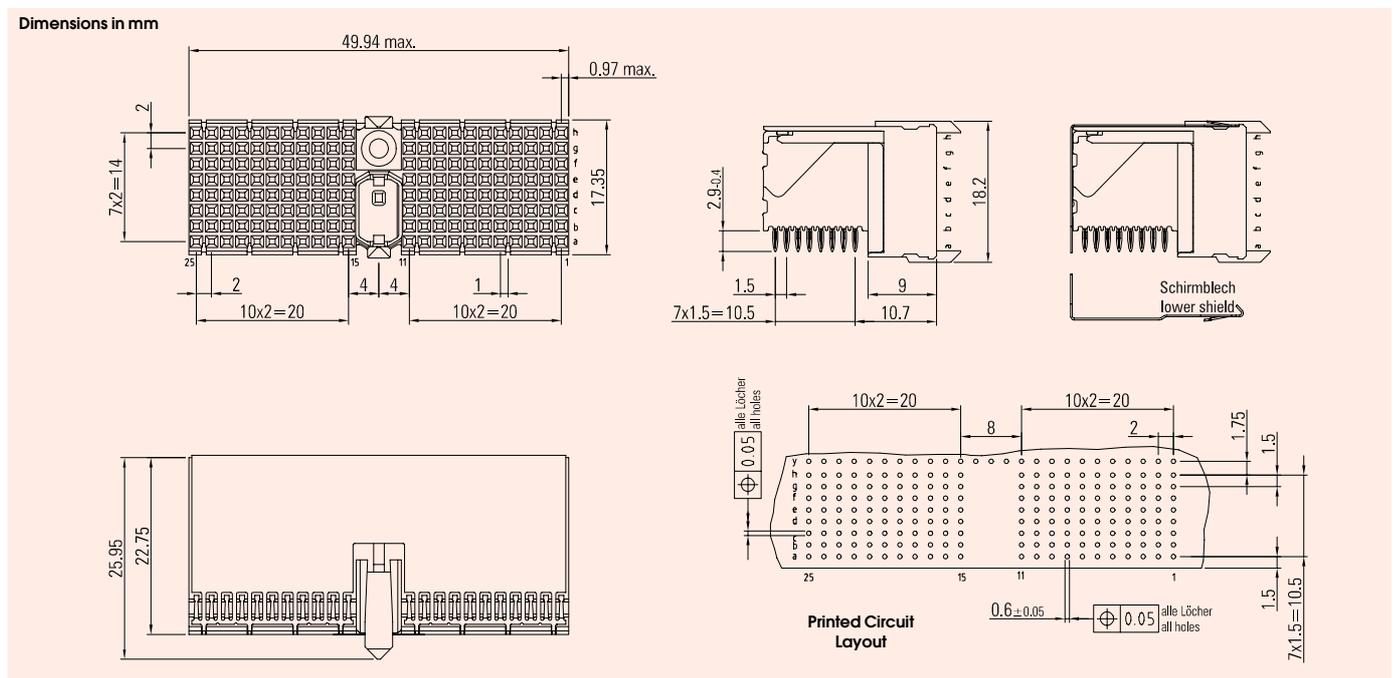

Type	No. of Positions	Part Numbers
connector without shielding	176	246-11000-15
connector with shielding	176	246-11300-15
lower shield		246-11600-1

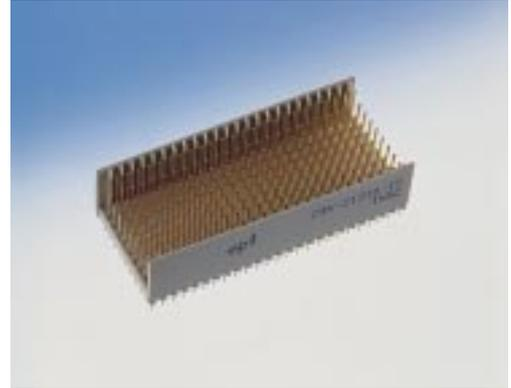

Male Connectors Type E

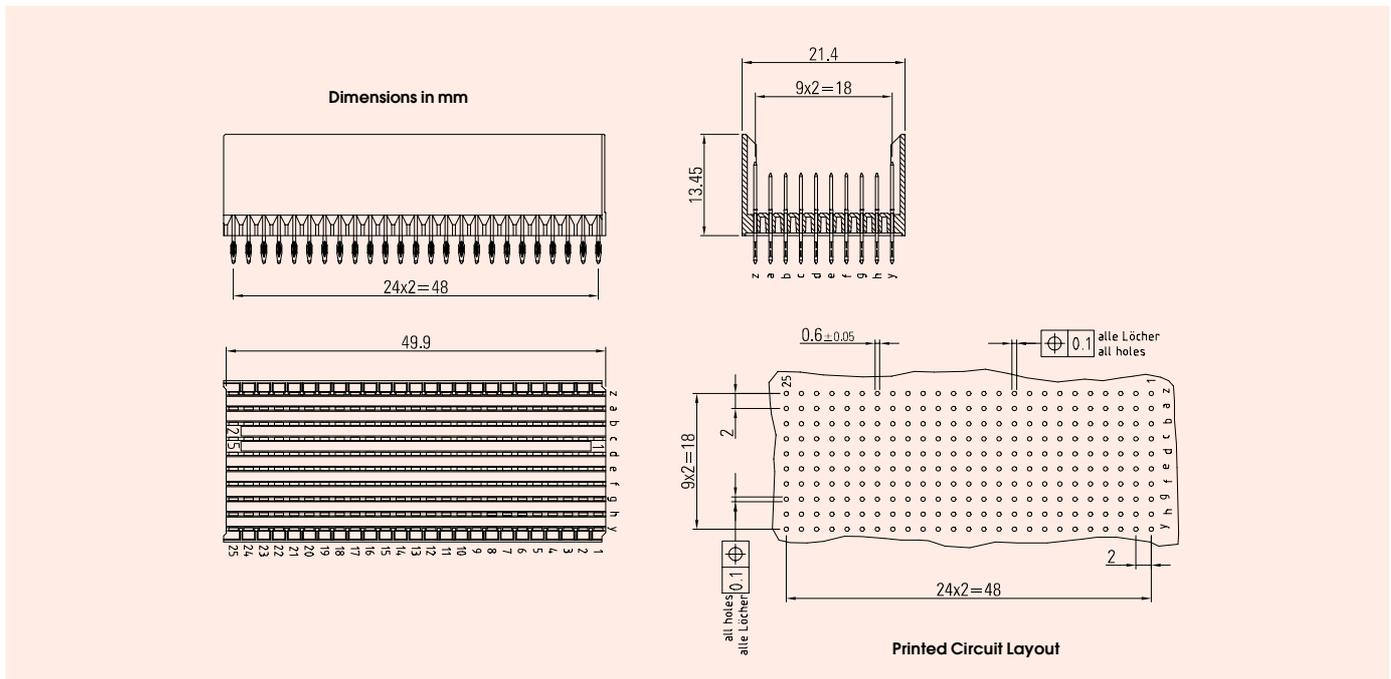

Assembly Drawing	No. of Positions	Row	Type	Pin length	Part Numbers
	200	z a b c d e f g h y	- A A A A A A A A -	-/ 8,25/3,7 8,25/3,7 8,25/3,7 8,25/3,7 8,25/3,7 8,25/3,7 8,25/3,7 8,25/3,7 -/-	245-21010-15
	250	z a b c d e f g h y	C A A A A A A A A A C	11,25/3,7 8,25/3,7 8,25/3,7 8,25/3,7 8,25/3,7 8,25/3,7 8,25/3,7 8,25/3,7 8,25/3,7 8,25/3,7 11,25/3,7	245-21310-15

Note: PCB thickness 1,6 - 2,8 mm Part No. XXX-XXXX-05

Insertion Tool: Part Number 884-711-W25



Female Connectors Type E

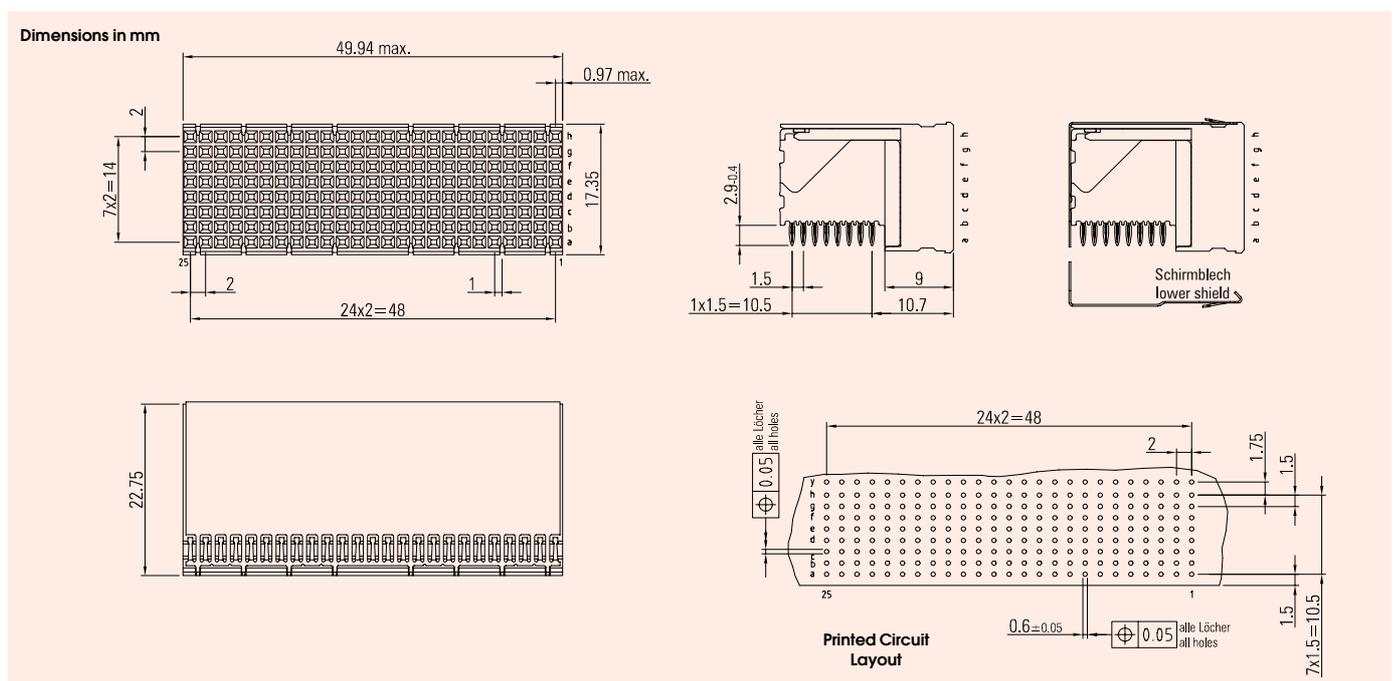

Type	No. of Positions	Part Numbers
connector without shielding	200	246-21000-15
connector with shielding	200	246-21300-15
lower shield		246-21600-1

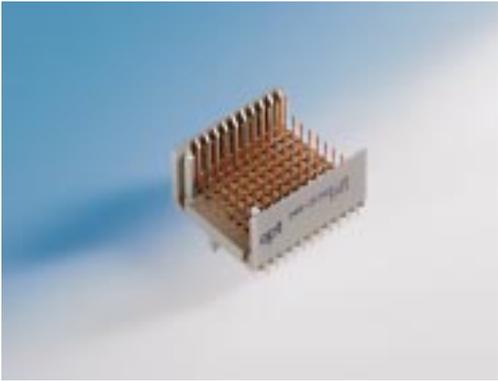

Male Connectors Type F

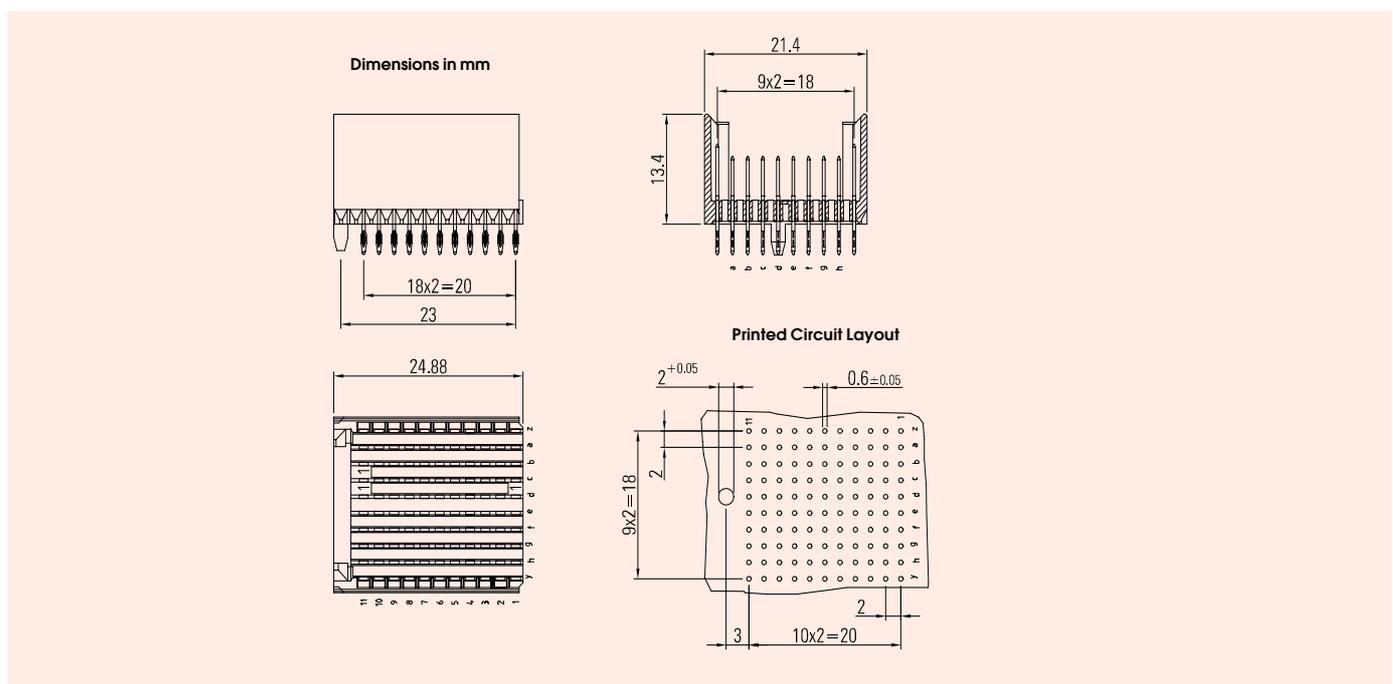

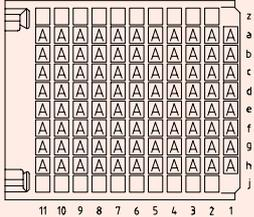
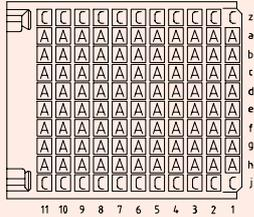
Assembly Drawing	No. of Positions	Row	Type	Pin length	Part Numbers
	88	z a b c d e f g h y	- A A A A A A A A -	-/- 8,25/3,7 8,25/3,7 8,25/3,7 8,25/3,7 8,25/3,7 8,25/3,7 8,25/3,7 8,25/3,7 -/-	245-31010-15
	110	z a b c d e f g h y	C A A A A A A A A C	11,25/3,7 8,75/3,7 8,75/3,7 8,75/3,7 8,75/3,7 8,75/3,7 8,75/3,7 8,75/3,7 8,75/3,7 11,25/3,7	245-31310-15

Note: PCB thickness 1,6 - 2,8 mm Part No. XXX-XXXX-05

Insertion Tool: Part Number 884-713-W11



Female Connectors Type F

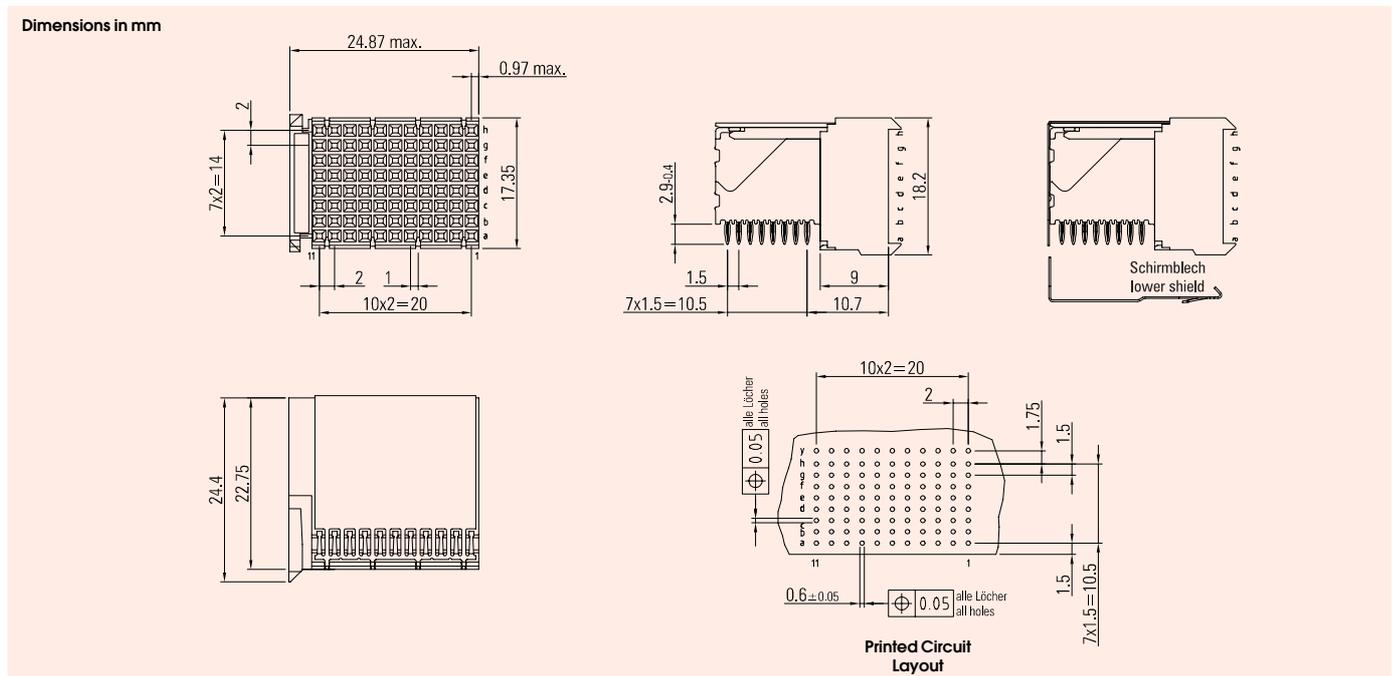

Type	No. of Positions	Part Numbers
connector without shielding	88	246-31000-15
connector with shielding	88	246-31300-15
lower shield		246-31600-1



Female Connectors Type DE

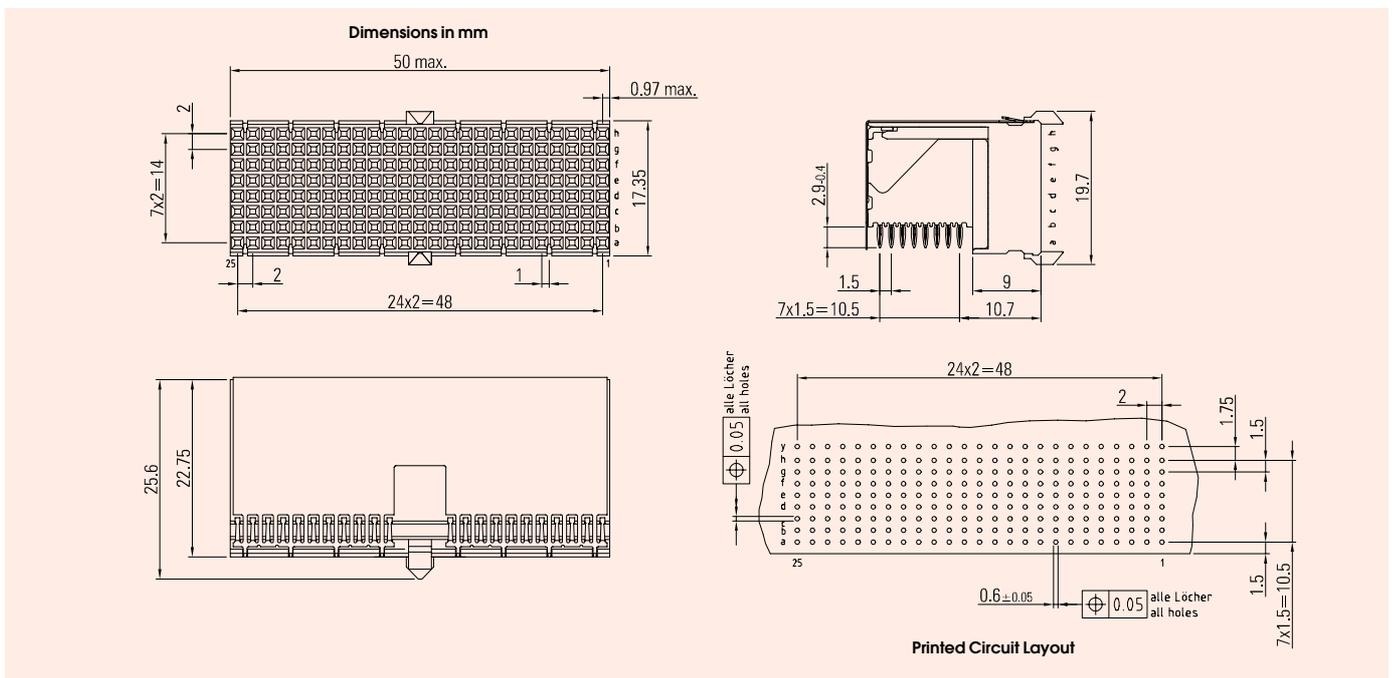

Type	No. of Positions	Part Numbers
connector without shielding	200	246-61000-15
connector with shielding	200	246-61300-15
lower shield		246-11600-1

Insertion tool: Part Number

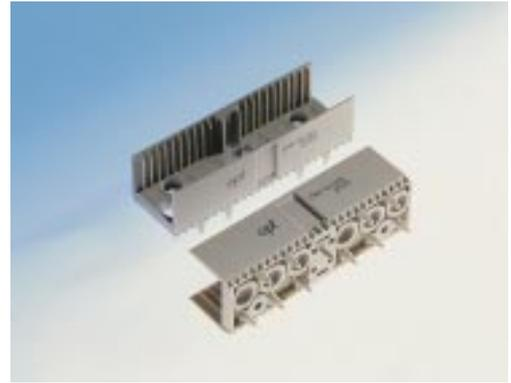

Male Connectors Type L

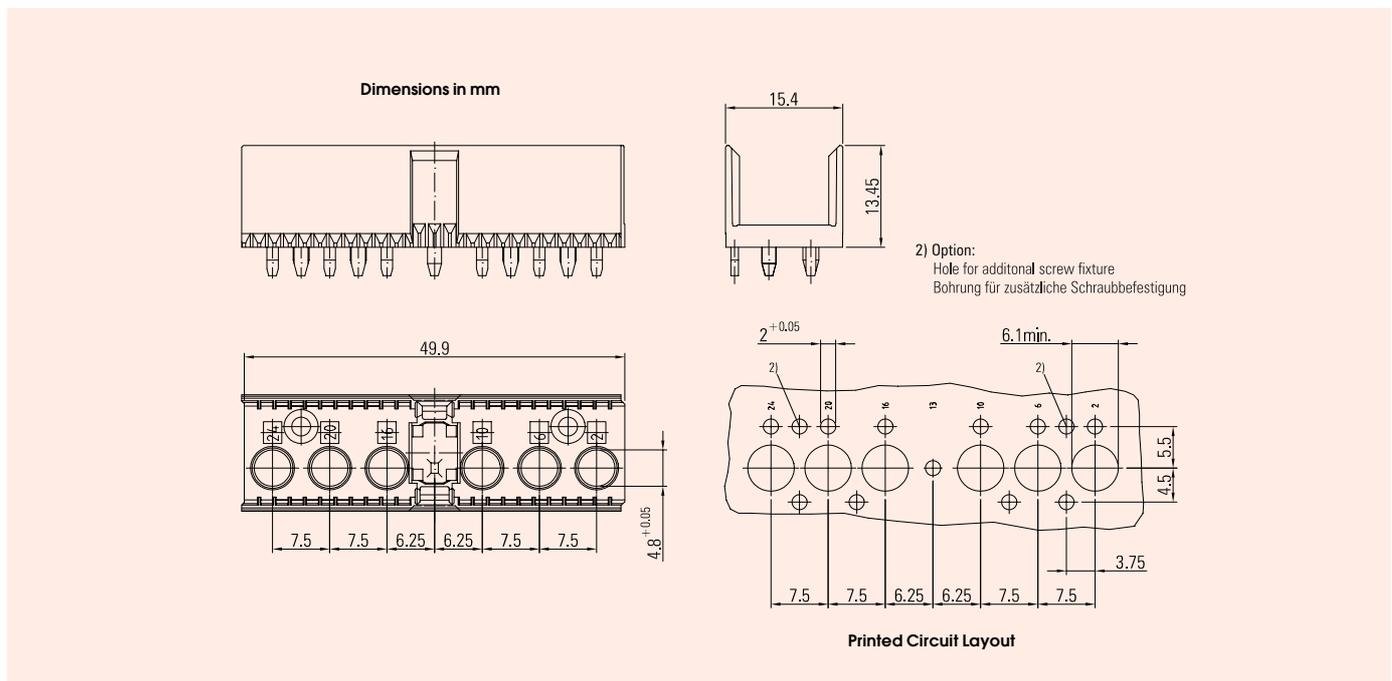

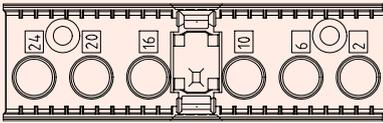
Assembly Drawing	No. of Positions	Row	special contact	Part Number
	6	-	power / cable contacts	243-51000
			pressfit coax	243-53000

Insertion Tool: Part Number 884-707-W1



Female Connectors Type L

Dimensions in mm

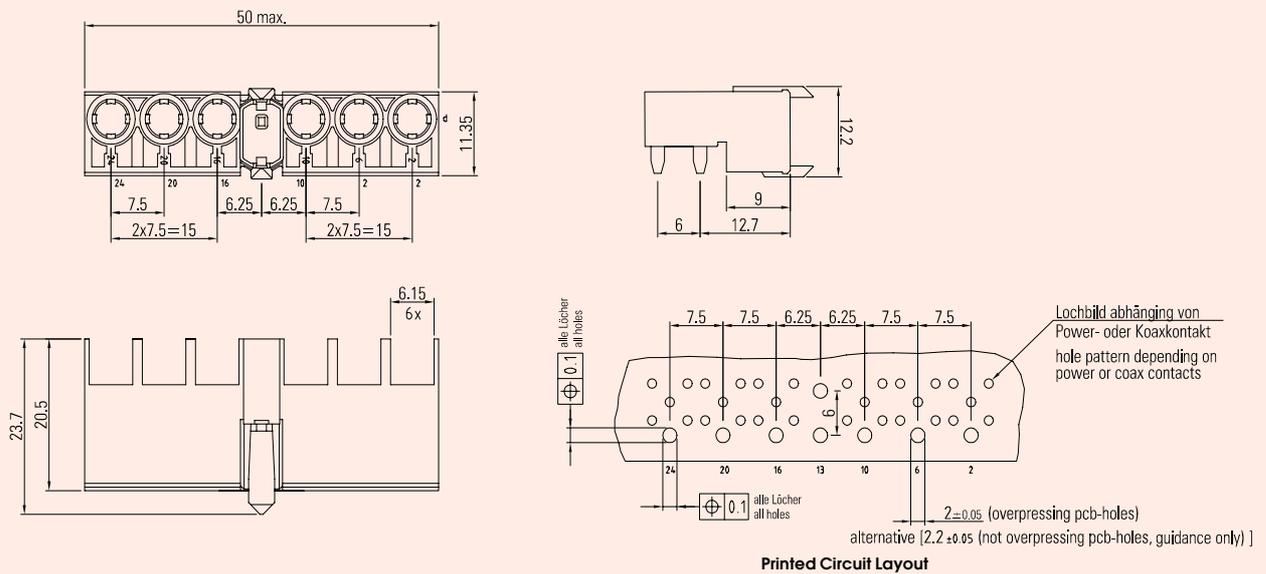

Type	No. of Positions	Part Number
connector without shielding	6	244-51000

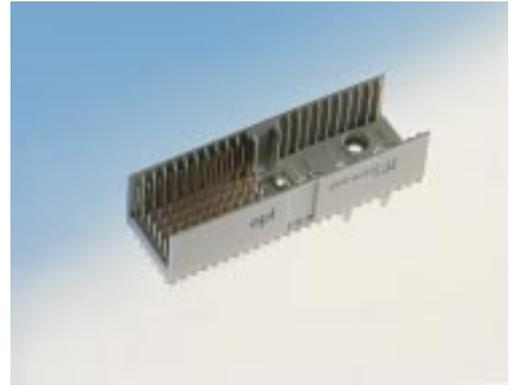

Male Connectors Type M

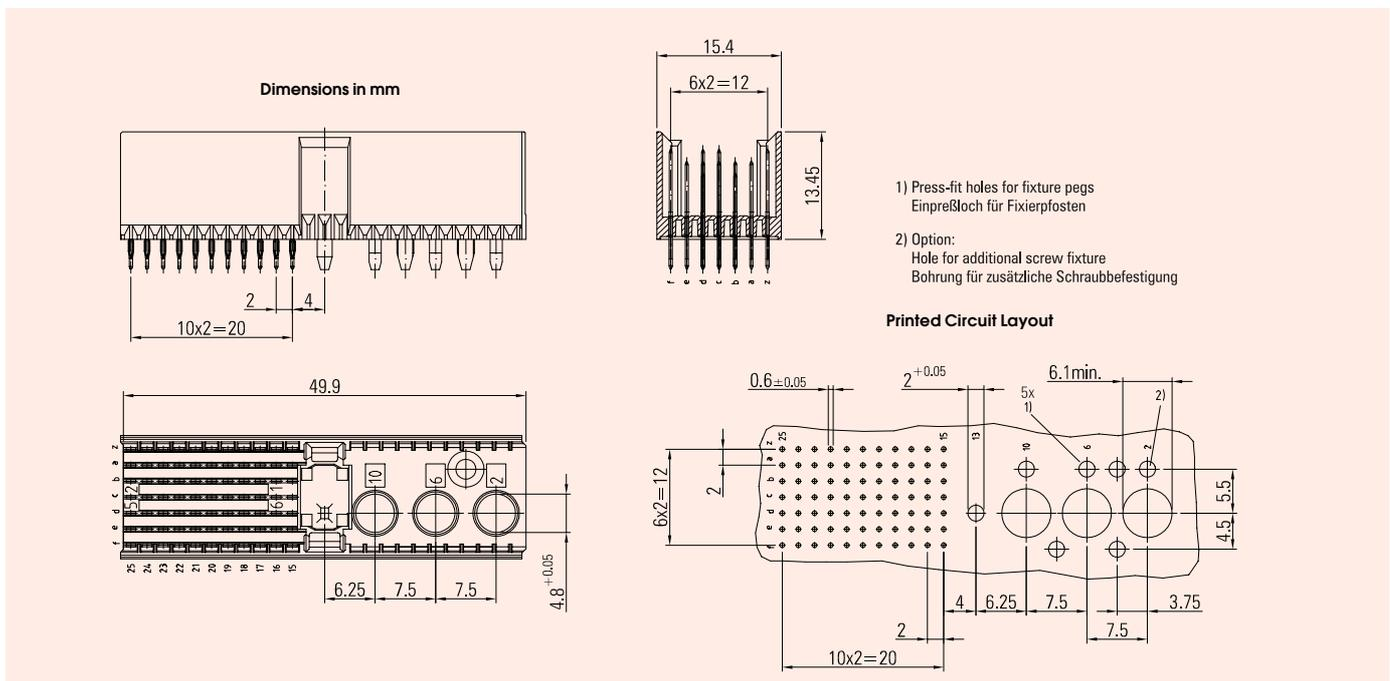

Assembly Drawing	No. of Positions	Row	Type	Pin length	special contacts	Part Numbers
	55+3	z	-	-/-	power / cable contacts	243-41010-15
		a	A	8,25/3,7		
		b	A	8,25/3,7		
		c	A	8,25/3,7	pressfit coax	243-42010-15
		d	A	8,25/3,7		
		e	A	8,25/3,7		
f	-	-/-				
	77+3	z	C	11,25/3,7	power / cable contacts	243-41310-15
		a	A	8,25/3,7		
		b	A	8,25/3,7		
		c	A	8,25/3,7	pressfit coax	243-42310-15
		d	A	8,25/3,7		
		e	A	8,25/3,7		
f	C	11,25/3,7				

Insertion Tool: Part Number 884-707-W2



Female Connectors Type M

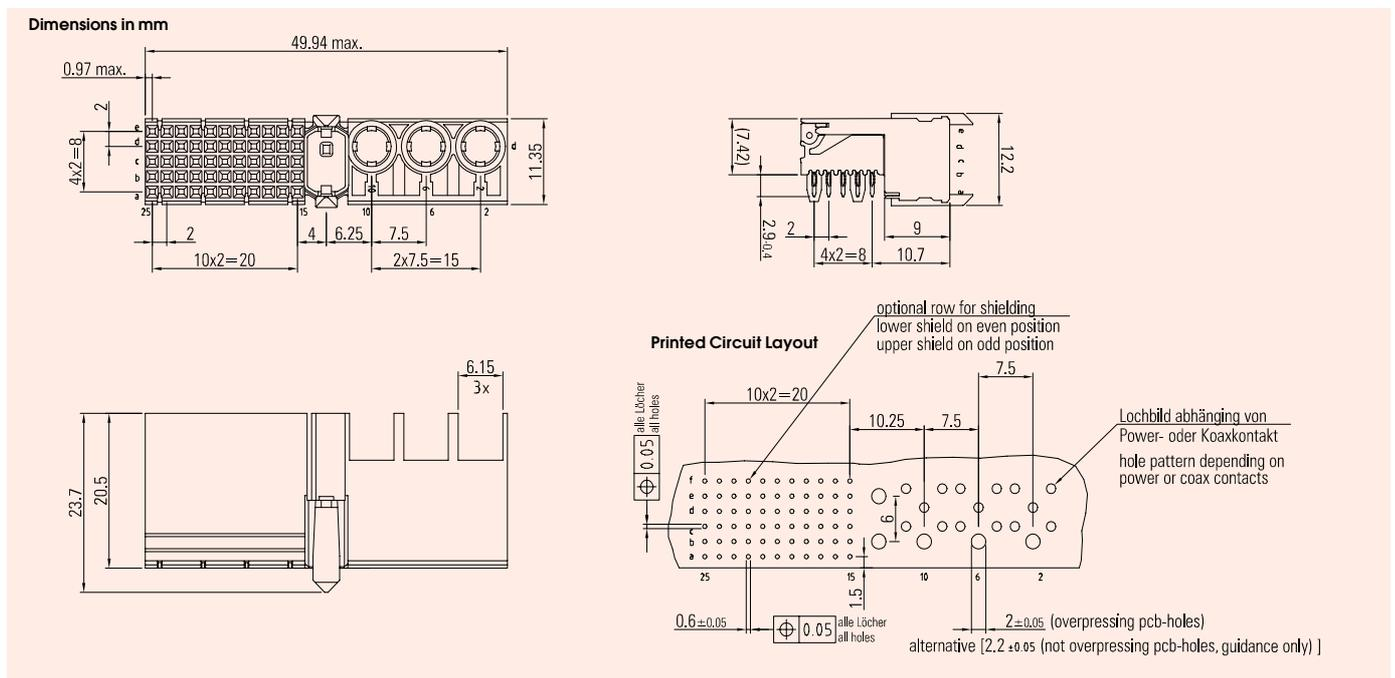

Type	No. of Positions	Part Numbers
connector without shielding	55+3	244-41000-15
connector with shielding	55+3	244-41300-15
lower shield		244-31600-1

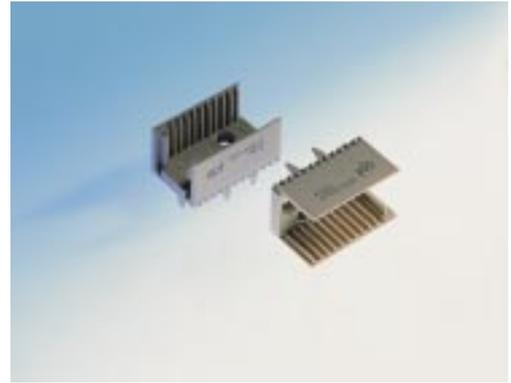

Male Connectors Type N

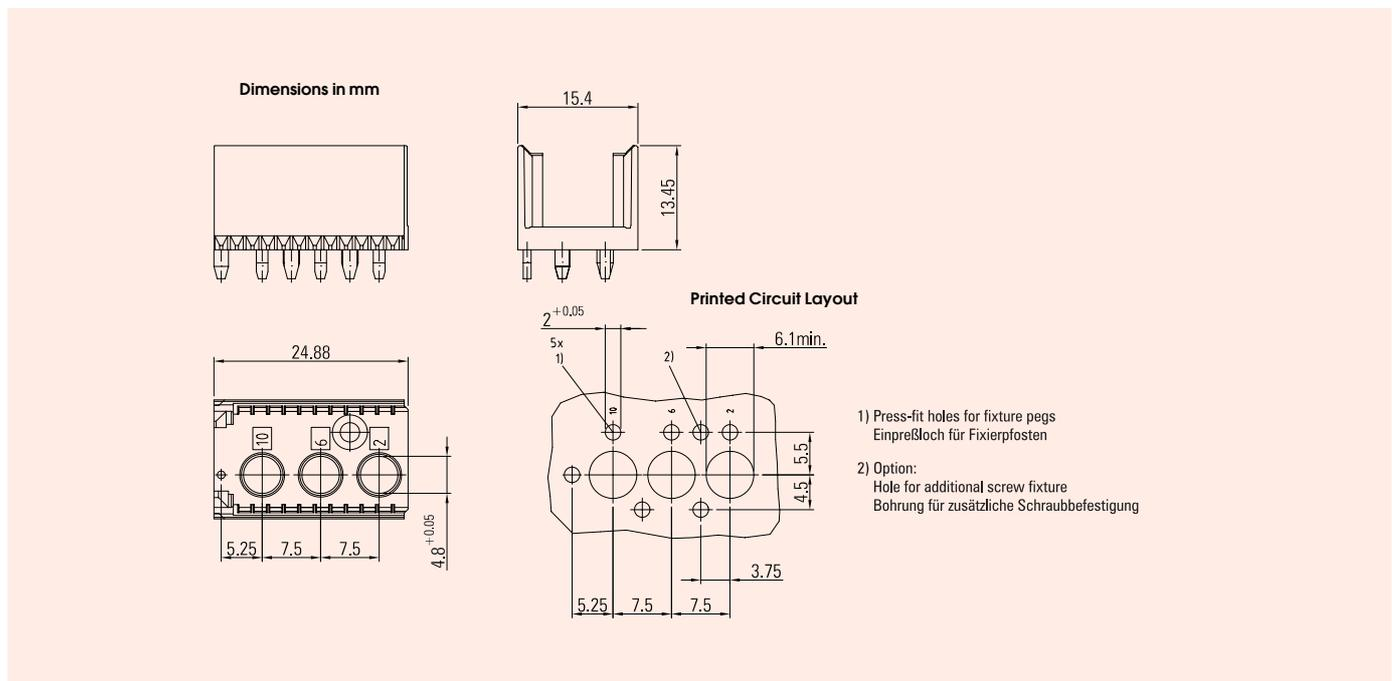

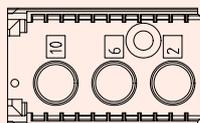
Assembly Drawing	No. of Positions	Row	special contact	Part Number
	3	-	power / cable contacts	243-52000
			pressfit coax	243-54000

Insertion Tool: Part Number **884-707-W3**



Female Connectors Type N

Dimensions in mm

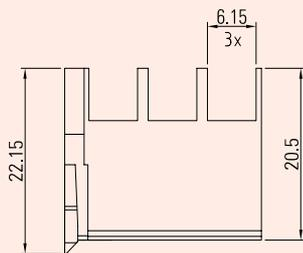
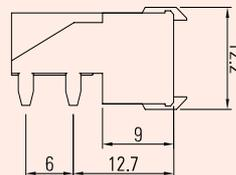
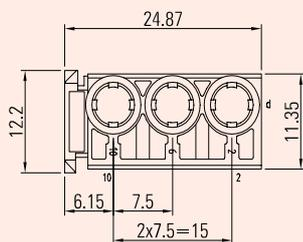

Printed Circuit Layout

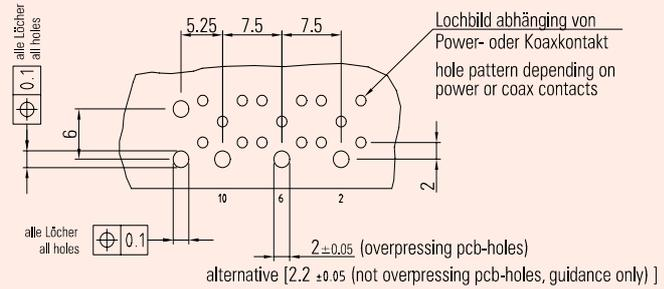

Type	No. of Positions	Part Number
connector without shielding	3	244-52000



High Current Contacts for use with Type L, M and N

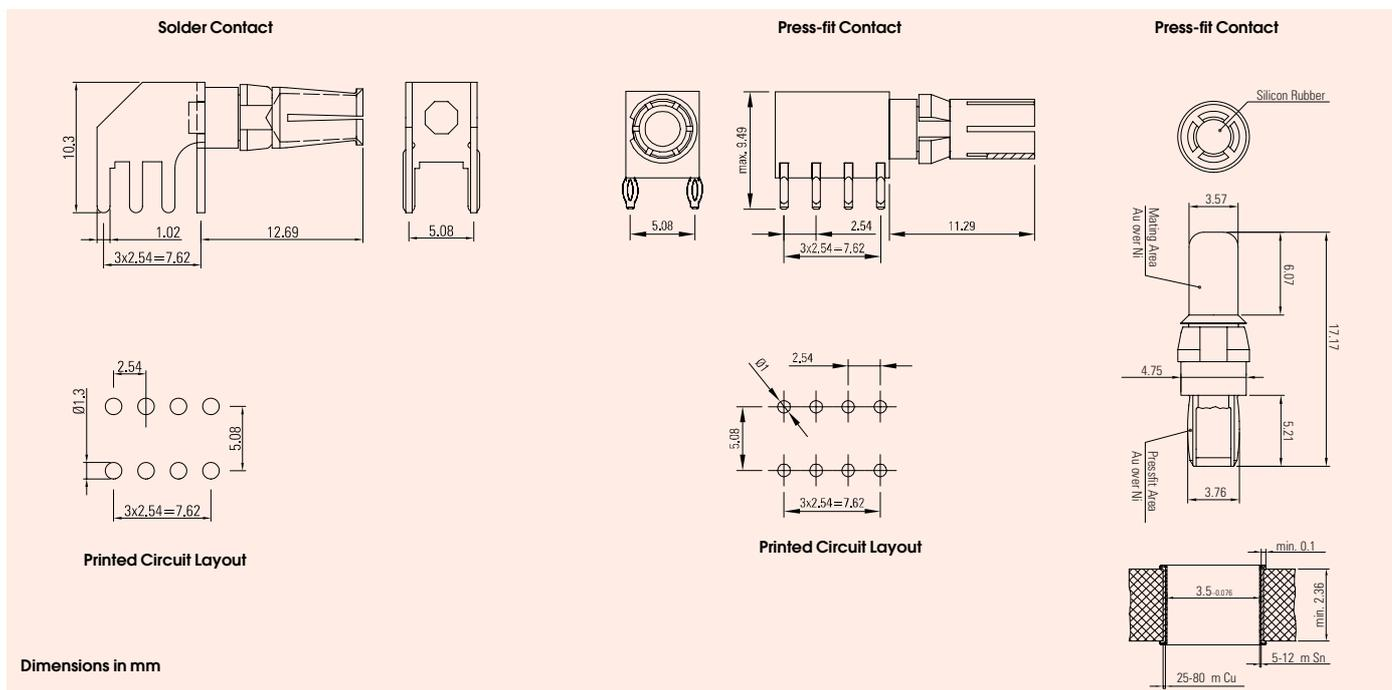

Termination Methods	Operating Current	Part Numbers
Solder Female Contact	30 A	916-42002
Press-fit Female Contact	40 A	916-62002
Press-fit Male Contact	40 A	915-61002



Coaxial Contacts for use with Type L, M and N

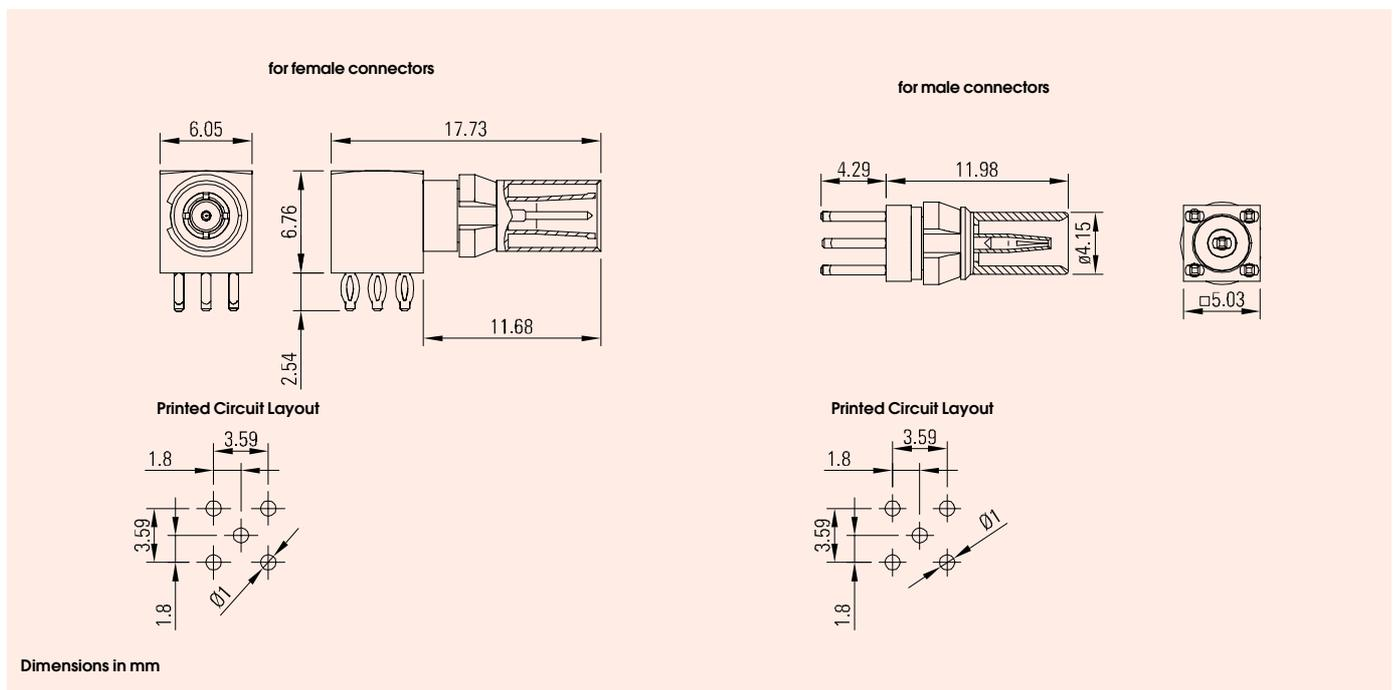

Termination Methods	Impedance	Part Numbers
for male connectors 243-42... / 243-53... / 243-54...	50 Ω	916-63002
for female connectors	50 Ω	915-64002

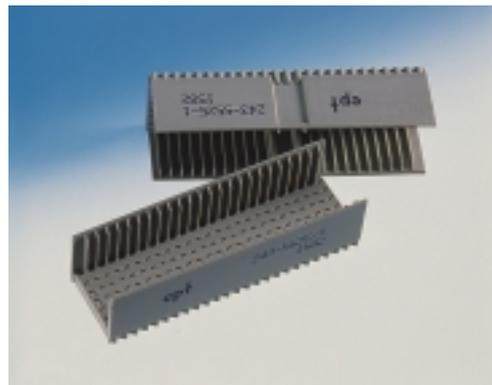

Shrouds for Male Connectors Type A, B, B-22, B-19 and C

Dimensions in mm

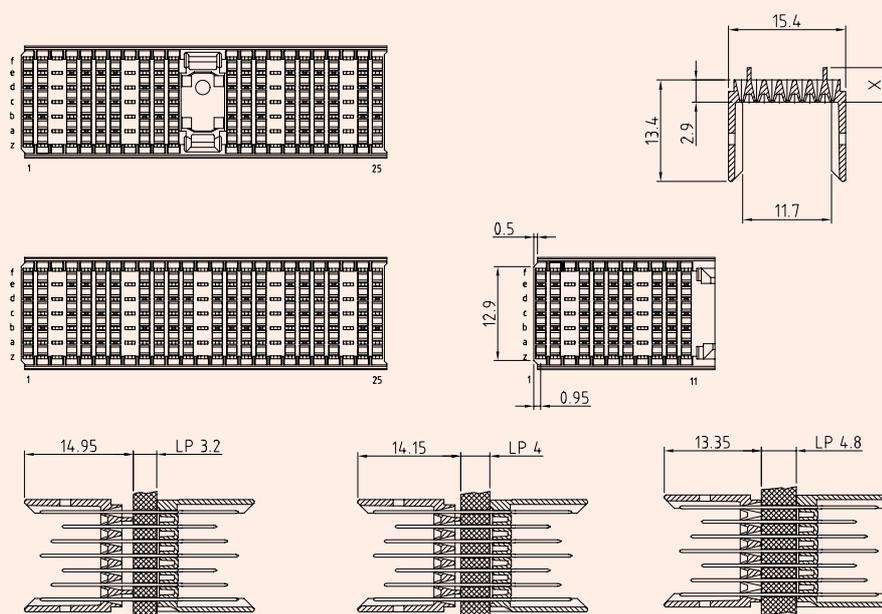

PCB thickness	<	<3,2 mm	3,2 - 4 mm	4,0 - 4,8 mm	> 4,8 mm
X	6,3 mm	4,9 mm	4,5 mm	3,7 mm	2,9 mm
Shroud	16,75 mm	15,35 mm	14,95 mm	14,15 mm	13,35 mm
Connector Type	Part Numbers				
A	243-5525-5	243-5525-4	243-5525-1	243-5525-2	243-5525-3
B	-	-	243-5625-1	243-5625-2	243-5625-3
B-22	243-5622-5	243-5622-4	243-5622-1	243-5622-2	243-5622-3
B-19	243-5619-5	243-5619-4	243-5619-1	243-5619-2	243-5619-3
C	-	-	243-5511-1	243-5511-2	243-5511-3

On request: other heights and special shrouds

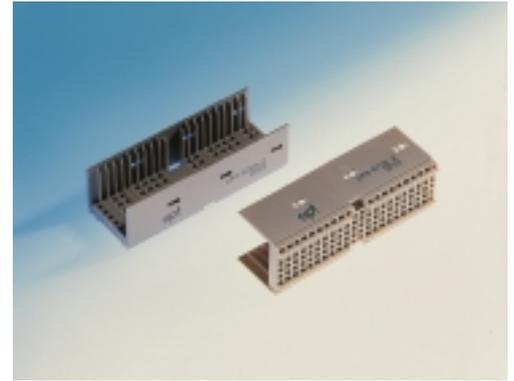

Shrouds for Male Connectors Type AB

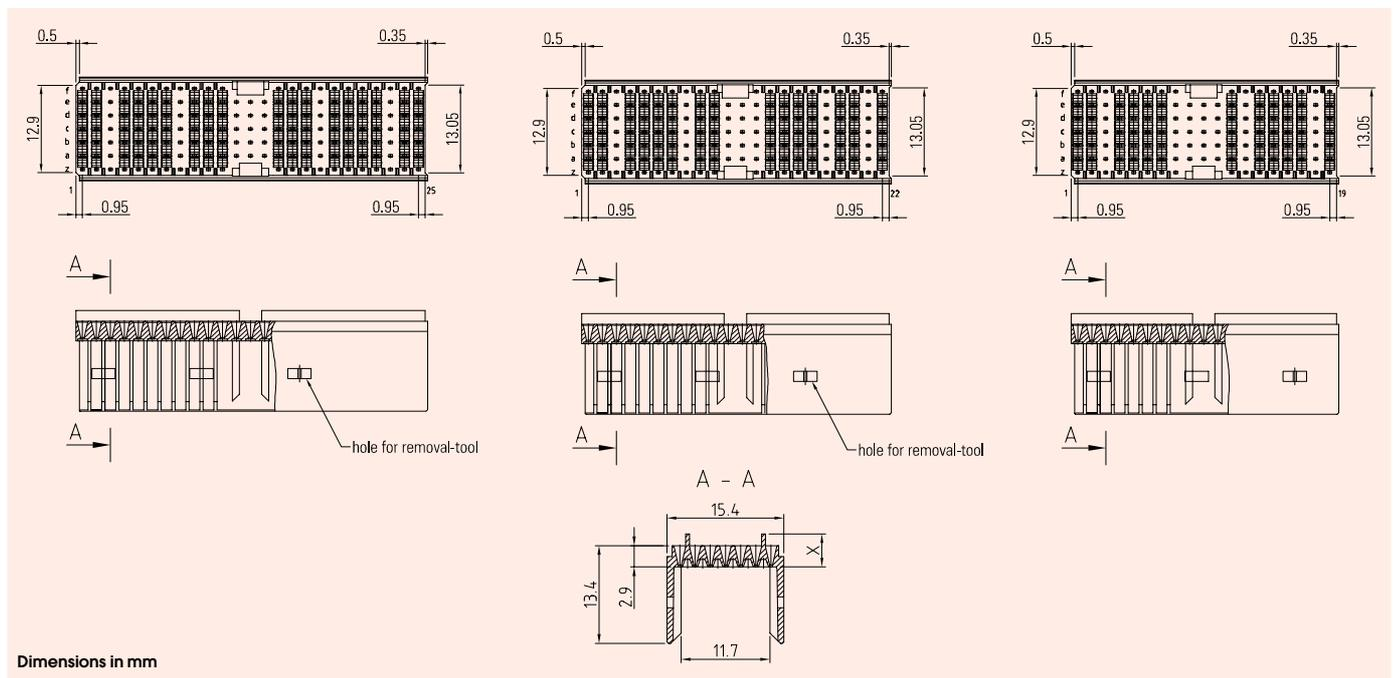

PCB thickness	<	< 3,2 mm	3,2 - 4 mm	4,0 - 4,8 mm	> 4,8 mm
x	6,3 mm	4,9 mm	4,5 mm	3,7 mm	2,9 mm
Shroud height	16,75 mm	15,35 mm	14,95 mm	14,15 mm	13,35 mm
Connector Type	Part Numbers				
AB-25	-	-	243-5725-1	243-5725-2	243-5725-3
AB-22	243-5722-5	243-5722-4	243-5722-1	243-5722-2	243-5722-3
AB-19	243-5719-5	243-5719-4	243-5719-1	243-5719-2	243-5719-3

On request: other heights and special shrouds

Overview compactPCI Connectors

Female connector for daughter card	Location	Shielding	ept Part Number
Type A	J1 / rJ1 / J4 / rJ4	With upper shield	244-11300-15
Type B22	J2 / J5	With upper shield	244-22300-15
Type AB22*	rJ2 / rJ5	With upper shield	244-62300-15
Type B19	J3	With upper shield	244-23300-15
Type AB19*	rJ3	With upper shield	244-63300-15
Type A for telephony	J4	With split shield	244-11305-15
Type A for telephony (mirrored)	rJ4	With split shield	244-11306-15

* AB connector are used for rear transition cards if AB shrouds are used
all connectors are also available without upper shield

Male connector for Backplane	Location	Contact loading *	ept Part Number
Type A Hot Swap	P1	CB***BC	243-11322-15
Type A Hot Swap for Midplane	P1	TP***PT	243-11710-15
Type monoblock Hot Swap	P1+P2	TP***PT	243-12322-15
Type B22	P2	CB***BC	243-22320-15
Type B22 AB compatible	P2 / P5	*PPPPP*	243-22361-15
Type B22 AB compatible	P2 / P5	*NNNNN*	243-22734-15
Type B22 AB compatible	P2 / P5	*SSSSS*	243-22371-15
Type B19	P3	CB***BC	243-23320-15
Type B19 AB compatible	P3	*PPPPP*	243-23361-15
Type B19 AB compatible	P3	*NNNNN*	243-23712-15
Type B19 AB compatible	P3	*SSSSS*	243-23371-15
Type A for telephony	P4	-*****	243-11323-15
Type A for telephony Midplane	P4	-*****	243-11709-15
Type A	P4	TP***PT	243-11360-15
Type A	P4	TNNNNNT	243-11734-15
Type A	P4	TSSSSST	243-11715-15
Type B22 for telephony	P5	C*****C	243-22311-15
Type B22 for telephony, Z row not loaded	P5	-*****C	243-22312-15
Type B22 for telephony, Z row not loaded	P5	-*****	243-22351-15

*different pins in that row / - not loaded
all connectors are also without Z row loaded available / for other pin arrangements consult ept

Coding keys	Color	application	ept Part Number
Male Backplane	Brilliant Blue	5V – P1	243-8014
Male Backplane	Cadmium Yellow	3,3V – P1	243-8031
Male Backplane	Strawberry red	Telephony – P4	243-8012
Female Daughtercard	Brilliant Blue	5V – J1	244-8014
Female Daughtercard	Cadmium Yellow	3,3V – J1	244-8031
Female Daughtercard Strawberry red		Telephony – J4	244-8012

Shrouds	Location	height	Base thickness	ept Part Number
Type A	P1 / P4	16,75 mm	6,3 mm	243-5525-5
Type A	P1 / P4	15,35 mm	4,9 mm	243-5525-4
Type A	P1 / P4	14,95 mm	4,5 mm	243-5525-1
Type A	P1 / P4	14,15 mm	3,7 mm	243-5525-2
Type A	P1 / P4	13,35 mm	2,9 mm	243-5525-3
Type AB22	P2 / P5	16,75 mm	6,3 mm	243-5722-5
Type AB22	P2 / P5	15,35 mm	4,9 mm	243-5722-4
Type AB22	P2 / P5	14,95 mm	4,5 mm	243-5722-1
Type AB22	P2 / P5	14,15 mm	3,7 mm	243-5722-2
Type AB22	P2 / P5	13,35 mm	2,9 mm	243-5722-3
Type AB19	P3	16,75 mm	6,3 mm	243-5719-5
Type AB19	P3	15,35 mm	4,9 mm	243-5719-4
Type AB19	P3	14,95 mm	4,5 mm	243-5719-1
Type AB19	P3	14,15 mm	3,7 mm	243-5719-2
Type AB19	P3	13,35 mm	2,9 mm	243-5719-3

The height / base thickness of the shrouds depend on the thickness of the Backplane

Coding Devices

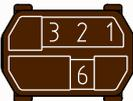
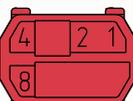
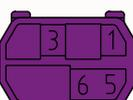
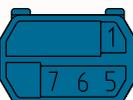
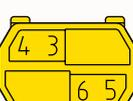

Male connectors

Coding key	Code No.	Colour	Part Numbers
	1236	Nut brown RAL 8011	243-8011
	1248	Strawberry red RAL 3018 Telephony Spec.	243-8012
	1356	Blue lilac RAL 4005	243-8013
	1567	Brilliant blue RAL 5007 5,0 V C-PCI	243-8014
	2578	Reseda green RAL 6011	243-8021
	3456	Cadmium yellow RAL 1021 3,3 V C-PCI	243-8031
	3467	Slate grey RAL 7015	243-8032
	3478	Steel blue RAL 5011	243-8033
	3568	Pastel orange RAL 2003	243-8034
	4678	Ocher yellow RAL 1024	243-8041

Female connectors

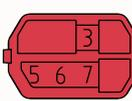
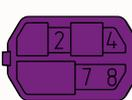
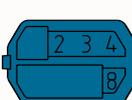
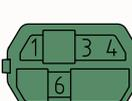
Coding key	Code No.	Colour	Part Numbers
	4578	Nut brown RAL 8011	244-8011
	3567	Strawberry red RAL 3018 Telephony Spec.	244-8012
	2478	Blue lilac RAL 4005	244-8013
	2348	Brilliant blue RAL 5007 5,0 V C-PCI	244-8014
	1346	Reseda green RAL 6011	244-8021
	1278	Cadmium yellow RAL 1021 3,3 V C-PCI	244-8031
	1258	Slate grey RAL 7015	244-8032
	1256	Steel blue RAL 5011	244-8033
	1247	Pastel orange RAL 2003	244-8034
	1235	Ocher yellow RAL 1024	244-8041

Fax request (5+2)

Company	Phone Number	
First Name	Last Name	Fax Number
Adress		E-Mail
Adress		Signature

Please quote me for _____ pieces.

Please send me _____ sample pieces.

Front view

Modul A

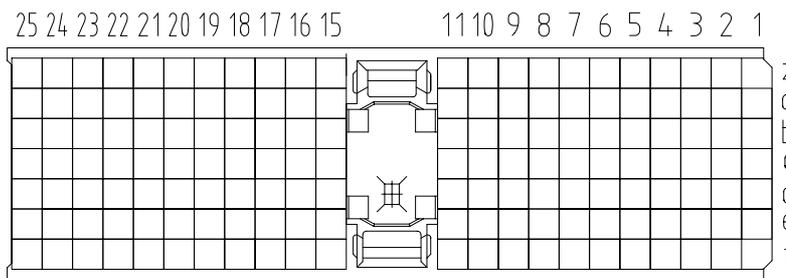

B25 B22 B19 Please mark by cross

Modul B

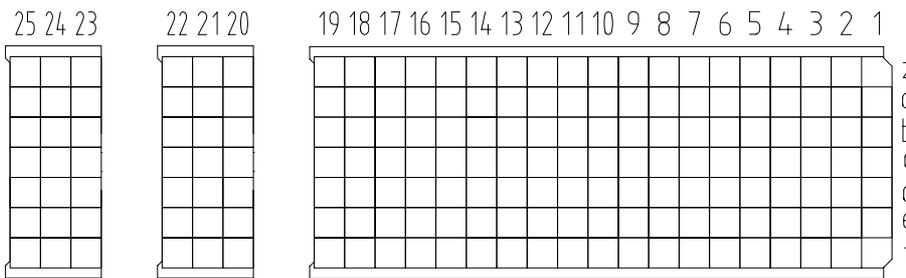

Modul C

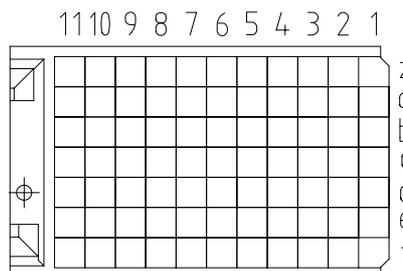

Assembly reference:

In order to be able to load the connectors economically we recommend a serial determination of the contact length. If only position 1 of a line is indicated, the entire line is loaded with this contact length. Exceptions can be registered at the respective position.

Surface:

Quality level 2 acc. to IEC 61076-4-101.
Au over PdNi over Ni.

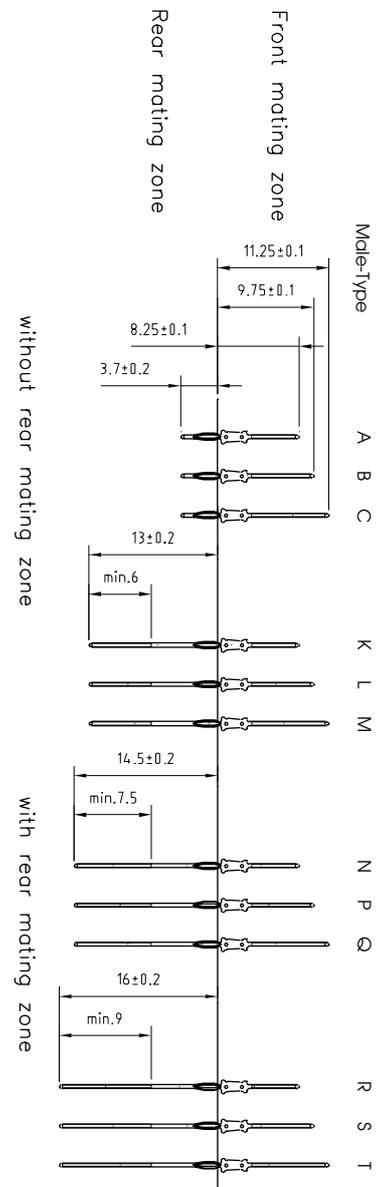

Fax request (8+2)

Company	Phone Number
First Name	Fax Number
Last Name	E-Mail
Adress	Signature
Adress	

Please quote me for _____ pieces.

Please send me _____ sample pieces.

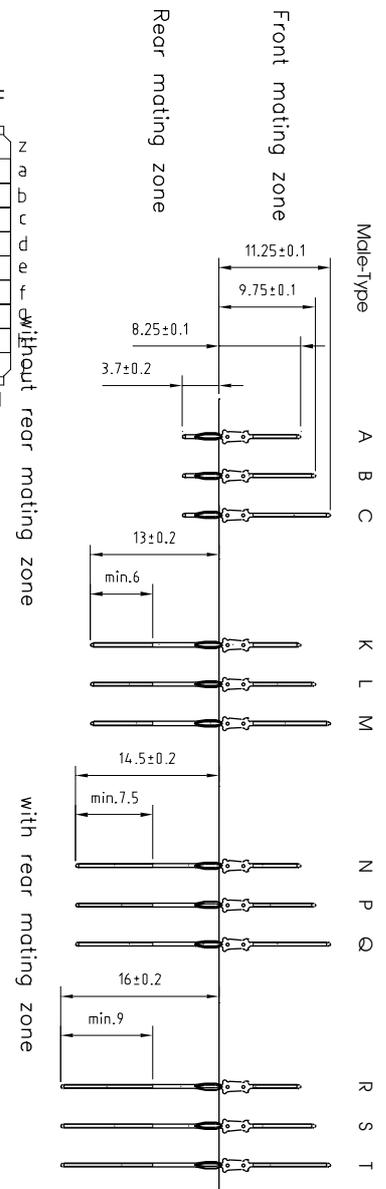
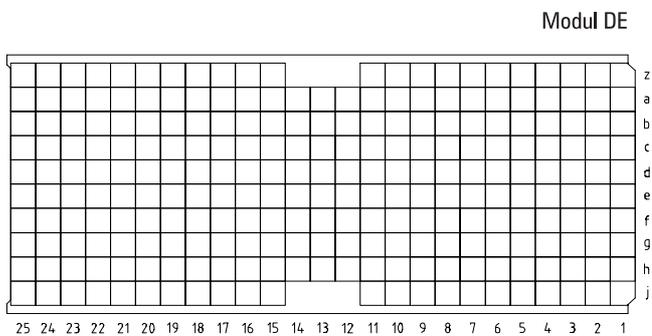
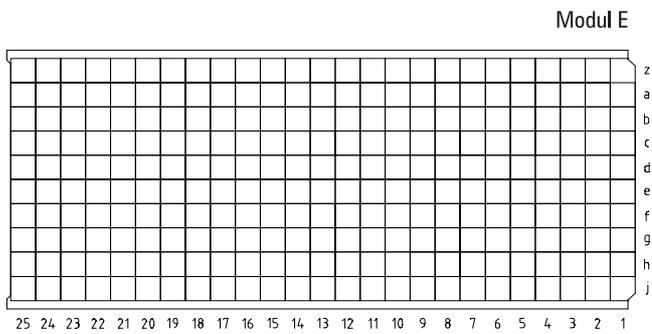
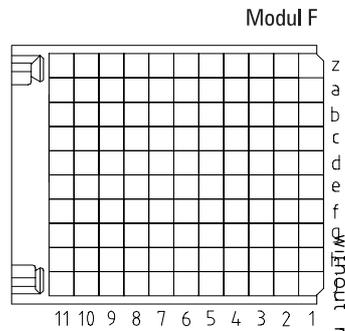
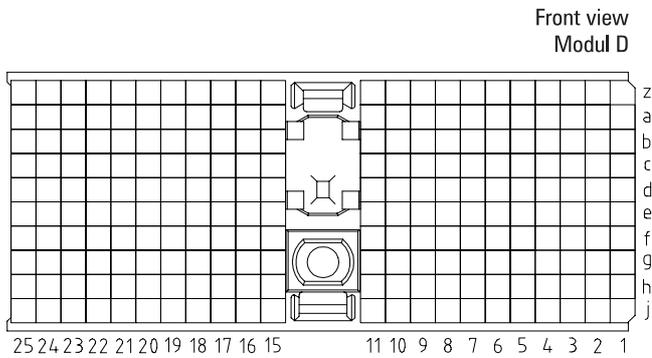

Assembly reference:

In order to be able to load the connectors economically we recommend a serial determination of the contact length. If only position 1 of a line is indicated, the entire line is loaded with this contact length. Exceptions can be registered at the respective position.

Surface:

Quality level 2 acc. to IEC 61076-4-101.
Au over PdNi over Ni.

Fax request AB

Company	Phone Number
First Name	Last Name
Adress	Fax Number
Adress	E-Mail
	Signature

Please quote me for _____ pieces.

Please send me _____ sample pieces.

Front view
Modul AB-19

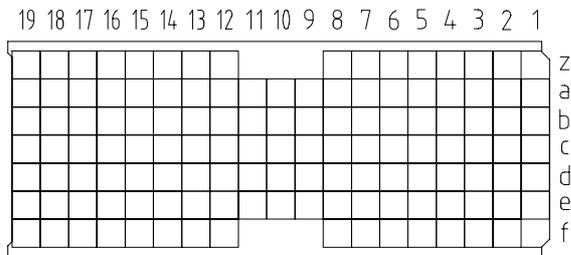

Modul AB-22

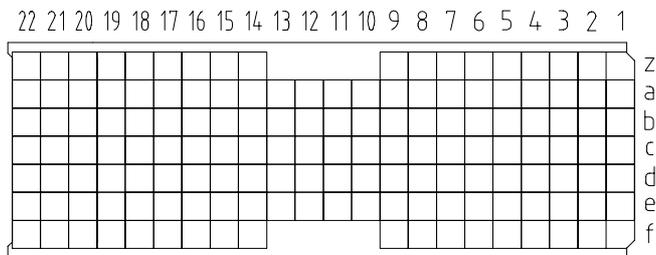

Modul AB-25

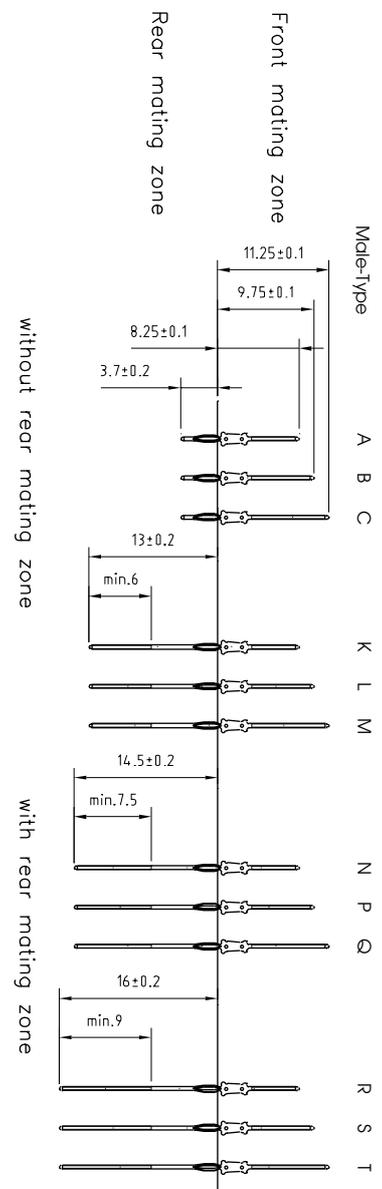
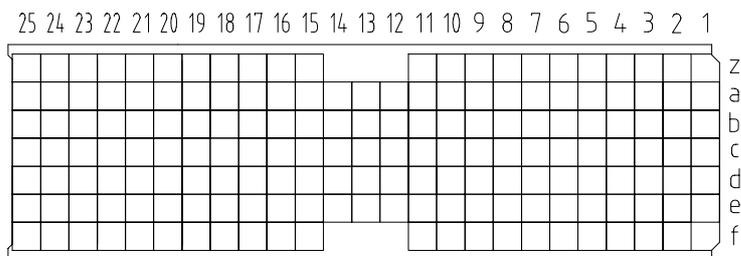

Assembly reference:

In order to be able to load the connectors economically we recommend a serial determination of the contact length. If only position 1 of a line is indicated, the entire line is loaded with this contact length. Exceptions can be registered at the respective position.

Surface:

Quality level 2 acc. to IEC 61076-4-101.
Au over PdNi over Ni.

X-ON Electronics

Largest Supplier of Electrical and Electronic Components

Click to view similar products for [FFC & FPC Connectors](#) category:

Click to view products by [EPT manufacturer](#):

Other Similar products are found below :

[HFW11R-1STE1H1LF](#) [FH29B-100S-0.2SHW\(99\)](#) [FA5S008HP1](#) [FH29B-120S-0.2SHW\(99\)](#) [FH29B-80S-0.2SHW\(99\)](#) [FHS-16](#) [FPH-2022G](#)
[52610-1075](#) [52610-1275](#) [52610-1934](#) [XF3M\(1\)-1415-1B-R100](#) [501864-3091-TR225](#) [0525594033](#) [086210010340800](#) [086222026001800](#)
[52271-2869-CUT-TAPE](#) [62674-201121DLF](#) [62684-36210E9ALF](#) [52610-1675](#) [52746-1671-TR250](#) [10051922-2810EHLF](#) [6-520415-9](#)
[BD021-09A-A1-0350-0200-0550-LD](#) [SFV6R-1STE9HLF](#) [XF3M-2915-1B-R100](#) [1658549-1](#) [62674-221121ALF](#) [46214008010800](#)
[046298003000883](#) [151660622](#) [842-816-2630-035](#) [AYF530665TA](#) [AYF351525](#) [046296011930846+](#) [AYF352325A](#) [046254020000800+](#)
[FH19C-13S-0.5SH\(99\)](#) [FH39J-51S-0.3SHW\(99\)](#) [AYF355125A](#) [AYF530365TA](#) [FH29B-44S-0.2SHW\(99\)](#) [SFW5R-2STAE9LF](#) [AYF351125A](#)
[AYF350725A](#) [62684-502100AHLF](#) [FH39-61S-0.3SHW\(99\)](#) [AYF414035A](#) [10064555-172520HLF](#) [AYF212335A](#) [504754-2500](#)