



Monitoring relays - GAMMA series

Multifunction

16.6 to 400Hz

Fault latch

Zoom voltage 24 to 240V AC/DC

2 change-over contacts

Width 22.5mm

Industrial design



## Technical data

### 1. Functions

AC/DC voltage monitoring in 1-phase mains with adjustable thresholds, timing for start-up suppression and tripping delay separately adjustable and the following functions (selectable by means of rotary switch)

|             |  |
|-------------|--|
| OVER        | Oversvoltage monitoring                                    |
| OVER+LATCH  | Oversvoltage monitoring with fault latch                   |
| UNDER       | Undersvoltage monitoring                                   |
| UNDER+LATCH | Undersvoltage monitoring with fault latch                  |
| WIN         | Monitoring the window between Min and Max                  |
| WIN+LATCH   | Monitoring the window between Min and Max with fault latch |

### 2. Time ranges

|                            |                  |
|----------------------------|------------------|
|                            | Adjustment range |
| Start-up suppression time: | 0s 10s           |
| Tripping delay:            | 0.1s 10s         |

### 3. Indicators

|                    |   |
|--------------------|---|
| Green LED ON:      | indication of supply voltage                                |
| Green LED flashes: | indication of start-up suppression time                     |
| Yellow LED ON/OFF: | indication of relay output                                  |
| Red LED ON/OFF:    | indication of failure of the corresponding threshold        |
| Red LED flashes:   | indication of tripping delay of the corresponding threshold |

### 4. Mechanical design

Self-extinguishing plastic housing, IP rating IP40  
 Mounted on DIN-Rail TS 35 according to EN 60715  
 Mounting position: any  
 Shockproof terminal connection according to VBG 4 (PZ1 required), IP rating IP20  
 Tightening torque: max. 1Nm  
 Terminal capacity:  
 1 x 0.5 to 2.5mm<sup>2</sup> with/without multicore cable end  
 1 x 4mm<sup>2</sup> without multicore cable end  
 2 x 0.5 to 1.5mm<sup>2</sup> with/without multicore cable end  
 2 x 2.5mm<sup>2</sup> flexible without multicore cable end

### 5. Input circuit

|                         |                  |  |
|-------------------------|------------------|--|
| Supply voltage:         | 24 to 240V AC/DC | terminals A1-A2 (galvanically separated) |
| Tolerance:              | 24 to 240V DC    | -20% to +25%                             |
|                         | 24 to 240V AC    | -15% to +10%                             |
| Rated frequency:        | 24 to 240V AC    | 48 to 400Hz                              |
|                         | 48 to 240V AC    | 16 to 48Hz                               |
| Rated consumption:      |                  | 4.5VA (1W)                               |
| Duration of operation:  |                  | 100%                                     |
| Reset time:             |                  | 500ms                                    |
| Wave form for AC:       |                  | Sinus                                    |
| Residual ripple for DC: |                  | 10%                                      |
| Drop-out voltage:       |                  | >15% of the supply voltage               |
| Oversvoltage category:  |                  | III (in accordance with IEC 60664-1)     |
| Rated surge voltage:    |                  | 4kV                                      |

### 6. Output circuit

|  |   |
|--|---|
| 2 potential free change-over contacts                    |   |
| Rated voltage:   | 250V AC   |
| Switching capacity:                                      | 750VA (3A / 250V AC)                                    |
| If the distance between the devices is less than 5mm!    |   |
| Switching capacity:                                      | 1250VA (5A / 250V AC)                                   |
| If the distance between the devices is greater than 5mm! |   |
| Fusing:  | 5A fast acting  |
| Mechanical life:   | 20 x 10 <sup>6</sup> operations                         |
| Electrical life:   | 2 x 10 <sup>5</sup> operations at 1000VA resistive load |
| Switching frequency:                                     | max. 60/min at 100VA resistive load                     |
|  | max. 6/min at 1000VA resistive load                     |
|  | (in accordance with IEC 60947-5-1)                      |
| Oversvoltage category:                                   | III (in accordance with IEC 60664-1)                    |
| Rated surge voltage:                                     | 4kV   |

### 7. Measuring circuit

|                        |                                      |
|------------------------|--------------------------------------|
| Fusing:                | max. 20A (in accordance with UL 508) |
| Measured variable:     | DC or AC Sinus (16.6 to 400Hz)       |
| Input:                 |                                      |
| 30V AC/DC              | terminals E-F1(+)                    |
| 60V AC/DC              | terminals E-F2(+)                    |
| 300V AC/DC             | terminals E-F3(+)                    |
| Overload capacity:     |                                      |
| 30V AC/DC              | 100Veff                              |
| 60V AC/DC              | 150Veff                              |
| 300V AC/DC             | 440Veff                              |
| Input resistance:      |                                      |
| 30V AC/DC              | 47kΩ                                 |
| 60V AC/DC              | 100kΩ                                |
| 300V AC/DC             | 470kΩ                                |
| Switching threshold    |                                      |
| Max:                   | 10% to 100% of U <sub>N</sub>        |
| Min:                   | 5% to 95% of U <sub>N</sub>          |
| Oversvoltage category: | III (in accordance with IEC 60664-1) |
| Rated surge voltage:   | 4kV                                  |

### 8. Accuracy

|                        |                                |
|------------------------|--------------------------------|
| Base accuracy:         | ≤5% (of maximum scale value)   |
| Frequency response:    | -10% to +5% (at 16.6 to 400Hz) |
| Adjustment accuracy:   | ≤5% (of maximum scale value)   |
| Repetition accuracy:   | ≤2%                            |
| Voltage influence:     | -                              |
| Temperature influence: | ≤0.05% / °C                    |

### 9. Ambient conditions

|                        |  |
|------------------------|--|
| Ambient temperature:   | -25 to +55°C<br>(in accordance with IEC 60068-1)<br>-25 to +40°C (in accordance with UL 508) |
| Storage temperature:   | -25 to +70°C   |
| Transport temperature: | -25 to +70°C   |
| Relative humidity:     | 15% to 85%<br>(in accordance with IEC 60721-3-3 class 3K3)                                   |
| Pollution degree:      | 3 (in accordance with IEC 60664-1)   |
| Vibration resistance:  | 10 to 55Hz 0.35mm<br>(in accordance with IEC 60068-2-6)                                      |
| Shock resistance:      | 15g 11ms (in accordance with IEC 60068-2-27)   |

## Functions

When the supply voltage U is applied, the output relays switch into on-position (yellow LED illuminated) and the set interval of the start-up suppression (START) begins (green LED U flashes). Changes of the measured voltage during this period do not affect the state of the output relay. After the interval has expired the green LED is illuminated steadily. For all the functions the LEDs MIN and MAX are flashing alternating, when the minimum value for the measured voltage was chosen to be greater than the maximum value.

### Overvoltage monitoring (OVER, OVER+LATCH)

When the measured voltage exceeds the value adjusted at the MAX-regulator, the set interval of the tripping delay (DELAY) begins (red LED MAX flashes). After the interval has expired (red LED MAX illuminated), the output relays switch into off-position (yellow LED not illuminated). The output relays again switch into on-position (yellow LED illuminated), when the measured voltage falls below the value adjusted at the MIN-regulator (red LED MAX not illuminated). If the fault latch is activated (OVER+LATCH) and the measured voltage remains above the MAX-value longer than the set interval of the tripping delay, the output relays remain in the off-position even if the measured voltage falls below the value adjusted at the MIN-regulator. After resetting the failure (interrupting and re-applying the supply voltage), the output relays switch into on-position and a new measuring cycle begins with the set interval of the start-up suppression (START).

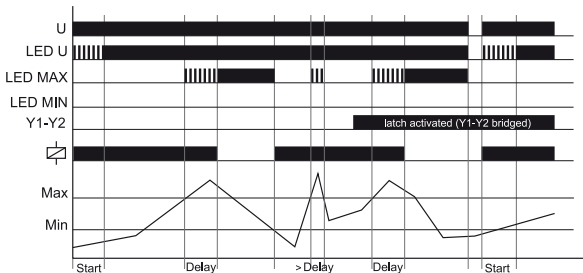

### Window function (WIN, WIN+LATCH)

The output relays switch into on-position (yellow LED illuminated) when the measured voltage exceeds the value adjusted at the MIN-regulator. When the measured voltage exceeds the value adjusted at the MAX-regulator, the set interval of the tripping delay (DELAY) begins (red LED MAX flashes). After the interval has expired (red LED MAX illuminated), the output relays switch into off-position (yellow LED not illuminated). The output relays again switch into on-position (yellow LED illuminated) when the measured voltage falls below the value adjusted at the MAX-regulator (red LED MAX not illuminated). When the measured voltage falls below the value adjusted at the MIN-regulator, the set interval of the tripping delay (DELAY) begins again (red LED MIN flashes). After the interval has expired (red LED MIN illuminated), the output relays switch into off-position (yellow LED not illuminated).

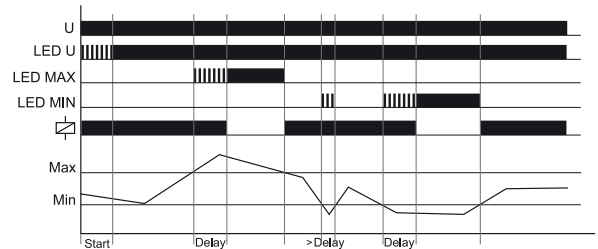

If the fault latch is activated (WIN+LATCH) and the measured voltage remains below the MIN-value longer than the set interval of the tripping delay, the output relays remain in the off-position even if the measured voltage exceeds the value adjusted at the MIN-regulator. If the measured voltage remains above the MAX-value longer than the set interval of the tripping delay, the output relays remain in the off-position even if the measured voltage falls below the value adjusted at the MAX-regulator. After resetting the failure (interrupting and re-applying the supply voltage), the output relays switch into on-position and a new measuring cycle begins with the set interval of the start-up suppression (START).

### Undervoltage monitoring (UNDER, UNDER+LATCH)

When the measured voltage falls below the value adjusted at the MIN-regulator, the set interval of the tripping delay (DELAY) begins (red LED MIN flashes). After the interval has expired (red LED MIN illuminated), the output relays switch into off-position (yellow LED not illuminated). The output relays again switch into on-position (yellow LED illuminated), when the measured voltage exceeds the value adjusted at the MAX-regulator. If the fault latch is activated (UNDER+LATCH) and the measured voltage remains below the MIN-value longer than the set interval of the tripping delay, the output relays remain in the off-position even if the measured voltage exceeds the value adjusted at the MAX-regulator. After resetting the failure (interrupting and re-applying the supply voltage), the output relays switch into on-position and a new measuring cycle begins with the set interval of the start-up suppression (START).

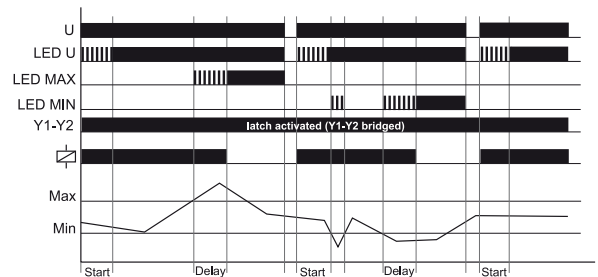
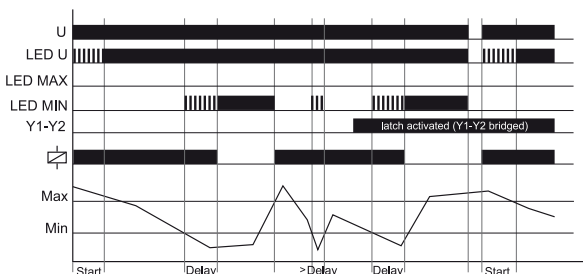

# G2UM300VL20 24-240V

## Connections

Range 300V, supply voltage 24V AC/DC and fault latch

Range 30V, supply voltage 24V AC/DC and fault latch

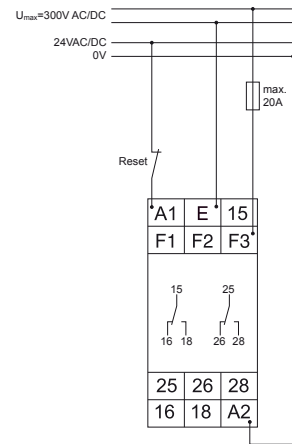
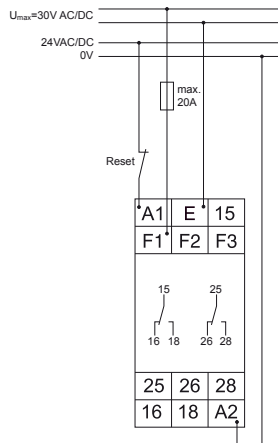

Range 60V, supply voltage 230V AC and fault latch

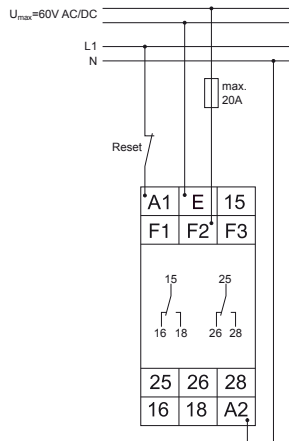

## Dimensions

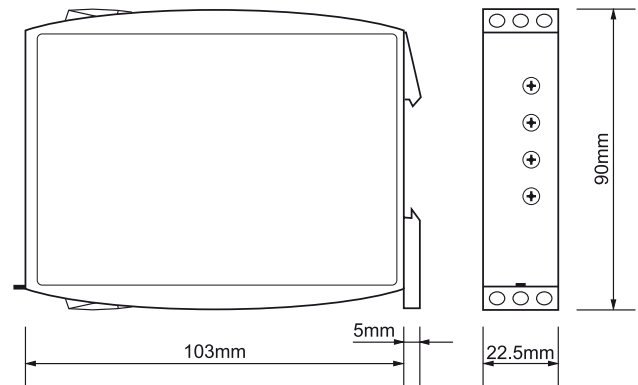

RELEASE 2009/07

Subject to alterations and errors

## **X-ON Electronics**

Largest Supplier of Electrical and Electronic Components

*Click to view similar products for [tele manufacturer](#):*

Other Similar products are found below :

[G2PF400VS02](#) [G2PM400VSY20 24-240VAC/DC](#) [E1ZM10 12-240VAC/DC](#)