

CONNECTORS SERIES 100

Series 100 Sub-miniature EHT connectors offer versatile interchangeable designs. Series 200 coaxial EHT connectors complement the Series 100 by offering similar interchangeable designs but with greatly increased voltage.

Cable entries are available for any particular cable required up to 0.285inch (7.44mm) diameter for Series 100 and 0.5inch (12.25mm) diameter Series 200. They are suitable for standard coaxial cables to BS 2316 and will also accept semi-air spaced, non-microphonic and other cables.

Included in the Series 200 range are 2 and 3 pole connectors and triaxial connectors. Protective caps and adaptors are included in both ranges.

GENERAL INFORMATION

1. Demountable connectors

Each connector has a discrete part number defining style, cable entry size and material. The middle three digits are determined by the cable to be used and the code obtained from the chart on page 4.

Wherever possible use one of the preferred cable entry sizes indicated.

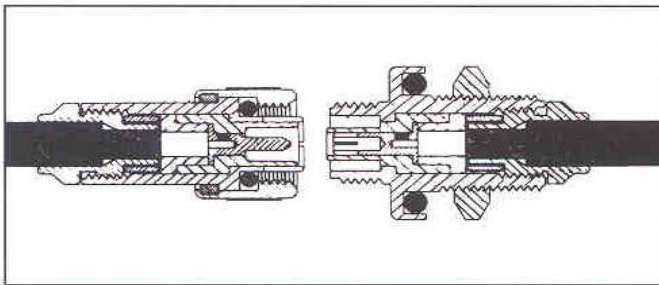

MECHANICAL DATA

Standard Materials

Shell	Series 100 – High tensile brass with nickel plate finish. Series 200 – Standard versions – corrosion resistant aluminium. (Brass versions with nickel plate available to special order).
Insulation	Demountable connectors: PTFE.
Centre Contacts	Female contacts: Copper alloy with silver plate finish. Male contacts: High tensile brass with silver plate finish.
Seals	Polythene insulation – nitrile rubber. PTFE insulation – silicone rubber.

Sealing

Series 100 connectors are interface sealed when mated, and bulkhead types are supplied with panel seals. Where appropriate, sealing conforms to the requirements of BS 9210 i.e. leakage rate of 1 cm³/hr max with a pressure differential of 100KN/m² (at ambient temperature.)

Working Temperature

Moulded Polythene insulation	-40° to +70°C.
PTFE insulation	-55° to +150°C.

ELECTRICAL DATA

Impedance Matching

The Series 100 and 200 range of coaxial connectors are both designed to match a 50 ohm system and at 1,500 MHz the VSWR does not exceed 1.3.

Working Voltage

The actual working voltage depends to a great extent upon the application, but as an indication for high voltage usage the following figures are typical:

	Series 100		Series 200	
	DC	AC	DC	AC
Demountable connectors	3kV	3kV pk	9kV	6kV pk
Demountable 'High Volt' connectors	—	—	30kV	20kV pk
Multiple and Triaxial connectors	—	—	3kV	3kV pk

Flashover Voltage

The maximum dc flashover voltage between inner conductor and outer shell at 760mm Hg. 20°C is:

	Series 100	Series 200
Mated coaxial demountable connectors	9kV	13kV
Coaxial unmated	5kV	13kV

Current Rating

Series 100 – Coaxial connectors	–2.5 Amps RMS
Series 200 – Coaxial connectors	–15 Amps RMS
Series 200 – Multipole connectors	–5.0 Amps RMS

Contact Resistance

The overall contact resistance does not exceed 3 milliohms for the inner and outer conductor circuits.

Insulation Resistance

The insulation resistance is better than 100,000 Megohms measured at 5kV.

Capacitance

The capacitance of a mated pair of Series 100 connectors is 2.8 pF and of Series 200 is 4.6 pF.

CONNECTORS SERIES 100

CABLE ENTRY CODES (xxx)

Part No Code xxx	Maximum Diameter						Typical Cables (Coaxial)
	Sheath	Inches Braid	Diel.	Sheath	Millimetres Braid	Diel.	
01A	.080	.060	.050	2.03	1.52	1.27	UR.94 RG.178/U
02A	.100	.070	.050	2.54	1.78	1.27	GO.1130
03A*	.115	.080	.070	2.92	2.04	1.78	URM.95 RG.174/U T.3204
04A	.115	.093	.070	2.92	2.36	1.78	T.3262
05A	.160	.105	.090	4.06	2.67	2.29	T.3252
05B	.160	.105	.070	4.06	2.67	1.70	T.3292
06A*	.175	.125	.100	4.45	3.17	2.54	T.(M)3188 RG.122/U
06B	.175	.125	.090	4.45	3.17	2.29	JO.2230
07A*†	.200	.145	.120	5.08	3.68	3.05	URM.43 URM.72 URM.76 URM.108 RG.58C/U
07C	.200	.145	.090	5.08	3.68	2.29	T.3250
08A	.210	.160	.130	5.33	4.06	3.30	T.(M)3172 T.(M)3020
09A*†	.233	.170	.130	5.92	4.32	3.30	UR.41 UR.56 URM.70 T.3242
09B	.233	.170	.155	5.92	4.32	3.94	UR.104 T.3237
09C	.233	.170	.120	5.92	4.32	3.05	
11A*†	.255	.178	.155	6.48	4.52	3.94	URM.90 UR.96 RG.598/U
12A	.237	.184	.155	6.02	4.67	3.94	T.3174
13B*	.285	.210	.180	7.24	5.33	4.57	T.3231
14A	.310	.230	.200	7.87	5.84	5.08	T.3169
15A*†	.325	.250	.200	8.27	6.35	5.08	UR.39 T.3205
16A	.365	.285	.200	9.27	7.24	5.08	T.3118
16B	.365	.285	.250	9.27	7.24	6.35	T.3040 T.3282
17A†	.415	.330	.285	10.54	8.39	7.37	URM.67 URM.102 UR.73 RG.8A/U
17B†	.415	.330	.285	10.54	8.39	7.37	URM.57 URM.65 UR.103 T.(M)3191
17C	.415	.330	.285	10.54	8.39	7.37	UR.31 UMR.64 UR.78 T.3236
18A	.460	.365	.290	11.68	9.28	7.37	URM.91 T.3281
18B	.460	.365	.330	11.68	9.28	8.38	UR.1 URM.21 T.3026
18C	.460	.365	.290	11.68	9.28	7.37	URM.60 UR.82
19A	.490	.390	.305	12.45	9.91	7.75	SRC.186
20A	.430	.345	.290	10.92	8.76	7.37	URM.112
21A	.245	.192	.155	6.22	4.87	3.94	RG.59B/UHT
23B	.155	.135	.100	3.81	3.43	2.54	RG.195A/U BELDEN 8218
24A	.255	.184	.155	6.48	4.67	3.94	T.(M)3174
26A†	.335	.280	.100	8.51	7.11	2.54	PET 2/1/P 3/1/P
13A†	.285	.210	.075	7.24	5.34	1.78	DRM.68 MPC.3416

Typical Cables (Triaxial)												
Code	Maximum Diameter Inches					Code	Maximum Diameter Millimetres					
	Sheath	1st Braid	2nd Braid	1st Diel.	2nd Diel.		Sheath	1st Braid	2nd Braid	1st Diel.	2nd Diel.	
25A	.280	.240	.165	.215	.130	DS/1/P DS/2/P	25A	7.11	6.09	4.19	5.46	3.30
27A	.330	.265	.172	.250	.130	T.3329	27A	8.38	6.73	4.37	6.35	3.30

Preferred Cable Ranges

*Series 100 †Series 200

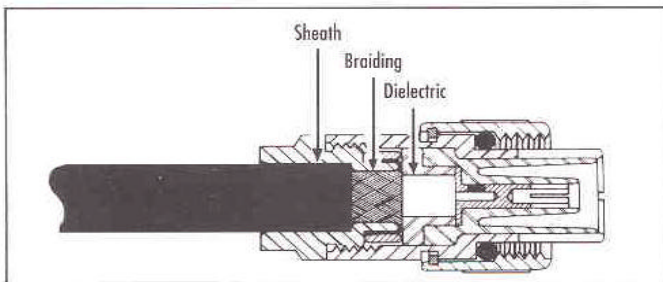

FOR CABLE SIZES NOT LISTED ABOVE PLEASE CONSULT OUR TECHNICAL SALES DEPT.

When considering the suitability of coaxial cables, the three dimensions illustrated show their relative importance from electrical and mechanical aspects.

The cable dielectric must be a good fit inside the rear insulator of the connector to ensure correct matching and good insulation.

Cable braiding requires to be as tight as is practical in the front portion of the body nut for efficient cable retention and electrical contact.

A good dust and dirt seal is ensured by making the cable sheath a tight fit in the rear portion of the body nut.

When considering these dimensions, account must be taken of cable manufacturers tolerances. Sizes shown in the table above indicate maximum diameters acceptable.

CONNECTORS SERIES 100

COAXIAL CABLE OUTLET



TYPE 101 CONNECTOR FREE, STRAIGHT ENTRY, MALE PIN

Part Number	Description	Weight
Preferred Cables: 551101-xxx-111	Non-Preferred Cables: 501101-xxx-01	101/BNP/PTFE/Demountable
		11.0 gm 0.39 oz

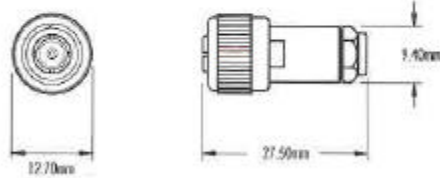

TYPE 102 CONNECTOR FREE, 90° ANGLE ENTRY, MALE PIN

Part Number	Description	Weight
Preferred Cables: 551102-xxx-111	Non-Preferred Cables: 501102-xxx-01	102/BNP/PTFE/Demountable
		17.0 gm 0.63 oz

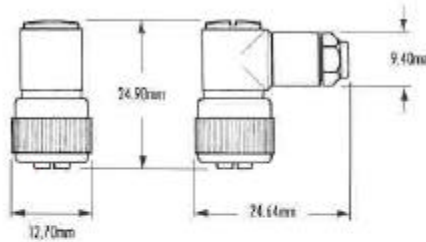

TYPE 111 CONNECTOR FIXED/FREE, STRAIGHT ENTRY, FEMALE CONTACT

Part Number	Description	Weight
Preferred Cables: 551111-xxx-111	Non-Preferred Cables: 501111-xxx-01	111/BNP/PTFE/Demountable
		11.9 gm 0.39 oz

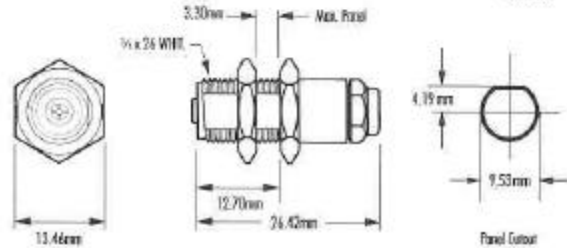

TYPE 121 CONNECTOR FIXED (FRONT), STRAIGHT ENTRY, FEMALE CONTACT

Part Number	Description	Weight
Preferred Cables: 551121-xxx-111	Non-Preferred Cables: 501121-xxx-01	121/BNP/PTFE/Demountable
		11.0 gm 0.39 oz

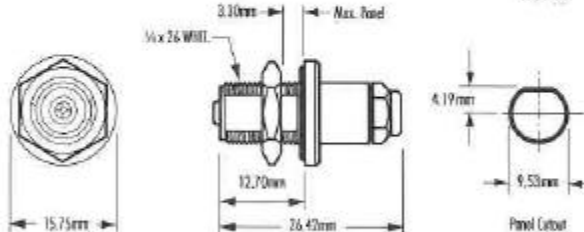

CONNECTORS SERIES 100



COAXIAL CABLE OUTLET

TYPE 122 CONNECTOR FIXED (REAR), STRAIGHT ENTRY, FEMALE CONTACT

Part Number		Description	Weight
Preferred Cables	Non-Preferred Cables		
551122-xxx-111	501122-xxx-01	122/BNP/PTFE/Demountable	16.5 gm 0.58 oz

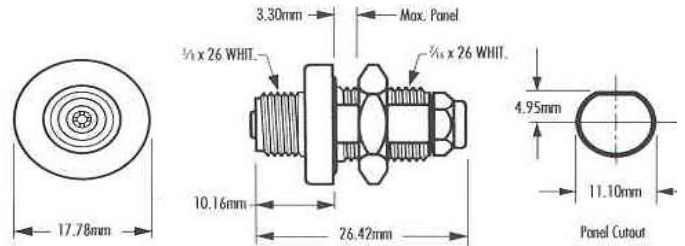

ASSEMBLY INSTRUCTIONS

Type 101 111 121 & 122

- (a) Body assembly
- (b) Front insulator
- (c) Inner contact
- (d) Rear insulator
- (e) Braid ring
- (f) Body nut

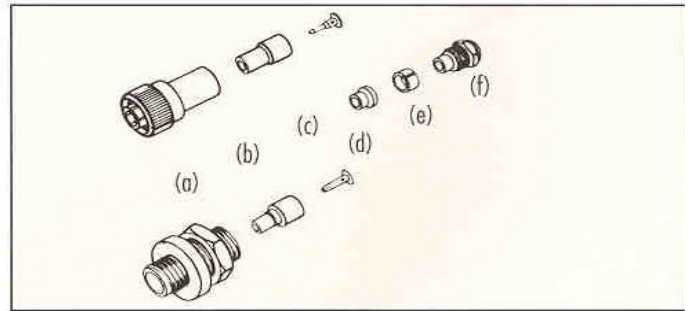

Fig. 1

Lightly coat all 'O' rings with silicone grease (MS 44) or approved equivalent. Lightly coat all threads with rocol grease RTD compound or approved equivalent. All dimensions given in inches.

Type 102

- (a) Front sub assembly
- (b) Cable entry

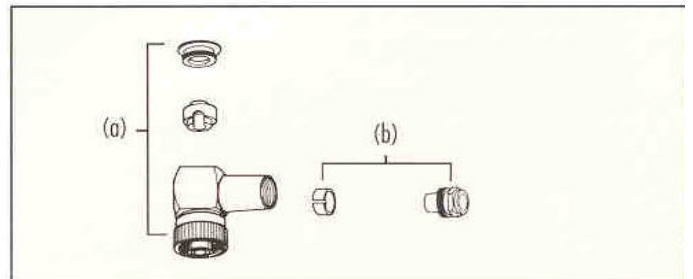

Fig. 2

All dimensions given in inches. Lightly coat all threads with rocol grease RTD compound or approved equivalent.

1
Cut face of cable square

2
Cut back sheath to expose braided screen
1 1/4 *

3
Push back braid and cut through dielectric and inner conductor
1/4

4
Pull braid forward and twist to provide easy lead into body nut

5
Slide body nut over braid until sheath reaches internal shoulder

6
Comb back braid over body nut spigot and cut off surplus, push braid ring over to retain braid

7
Slide rear insulator over dielectric. Cut back dielectric flush with front face of insulator to expose inner conductor

8
Cut back inner conductor to leave exposed length of 0.08 inches and solder contact in position
Final assembly can now be made by referring to fig. 1.

1
Cut face of cable square

2
Cut back sheath to expose braided screen
3/4 *
*on 13B cable entry this dim. to be 7/8"

3
Push back braid and cut through dielectric and inner conductor
1/4

4
Pull braid forward and twist to provide easy lead into body nut

5
Slide body nut over braid until sheath reaches internal shoulder

6
Comb back braid over body nut spigot and cut off surplus, push braid ring over to retain braid.

7
Cut back dielectric core to expose inner conductor 1/8"

8
SOLDER
Screw cable assembly into front sub assembly 'a' and solder inner conductor into slot provided on contact.
Final assembly can now be made by referring to fig. 2.

CONNECTORS **SERIES 100**



COAXIAL INSULATED FLYLEAD

TYPE 131 CONNECTOR FIXED (FRONT), STRAIGHT ENTRY, FEMALE CONTACT

Part Number	Description	Weight	
551131-000-211	131/BNP/POLY	10.5 gm	0.37 oz

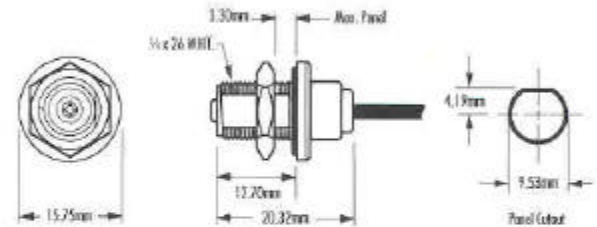

TYPE 132 CONNECTOR FIXED (REAR), STRAIGHT ENTRY, FEMALE CONTACT

Part Number	Description	Weight	
551132-000-211	132/BNP/POLY	16.5 gm	0.58 oz

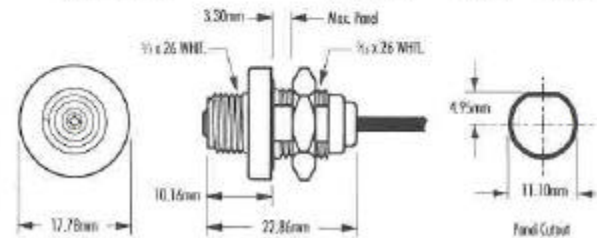

Flylead connectors are supplied with 24 inches (610 mm) exposed length of type 4 Polythene equipment wire. The Flylead forms an integral part of the moulded polythene insulator assembly.

COAXIAL SOLDER SPILL



TYPE 141 CONNECTOR FIXED (FRONT), STRAIGHT ENTRY, FEMALE CONTACT

Part Number	Description	Weight	
551141-000-111	141/BNP/PYFE	8.5 gm	0.30 oz

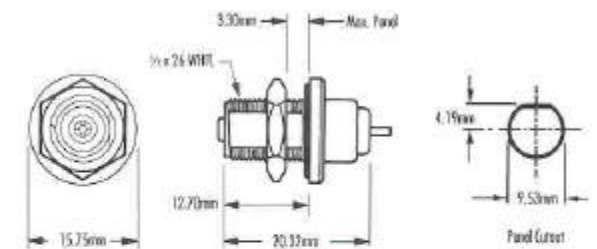

TYPE 142 CONNECTOR FIXED (REAR), STRAIGHT ENTRY, FEMALE CONTACT

Part Number	Description	Weight	
551142-000-111	142/BNP/PYFE	14.5 gm	0.51 oz

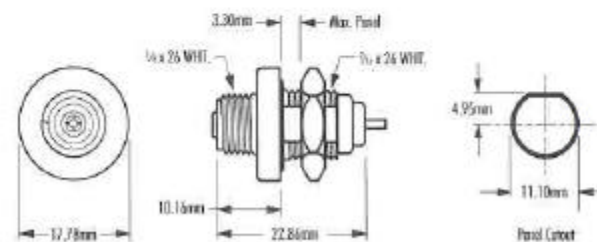

Solder spill connectors are supplied ready tinned

CONNECTORS **SERIES 100**



COAXIAL ADAPTORS

TYPE 151 ADAPTOR FIXED/FREE, STRAIGHT, FEMALE/FEMALE CONTACTS

Part Number	Description	Weight
551152-000-111	152/BNP/PTFE	10.0 gm 0.35 oz

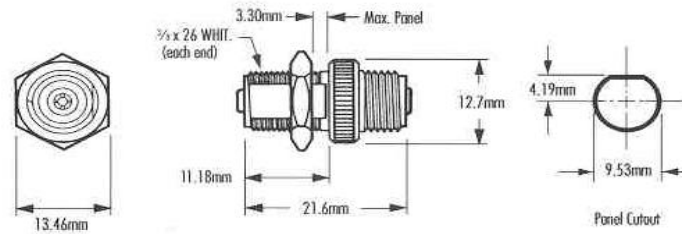

TYPE 152 ADAPTOR FIXED, STRAIGHT, FEMALE/FEMALE CONTACTS

Part Number	Description	Weight
551152-000-111	152/BNP/PTFE	9.5 gm 0.34 oz

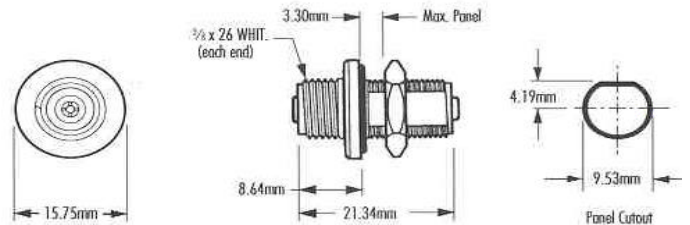

TYPE 156 ADAPTOR FREE, TEE JUNCTION, MALE/2 FEMALE CONTACTS

Part Number	Description	Weight
551156-000-211	156/BNP/POLY	21.0 gm 0.74 oz

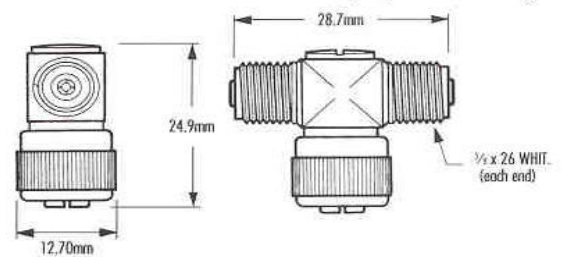

156 adaptors have completely moulded polythene insulation.

SERIES ADAPTORS

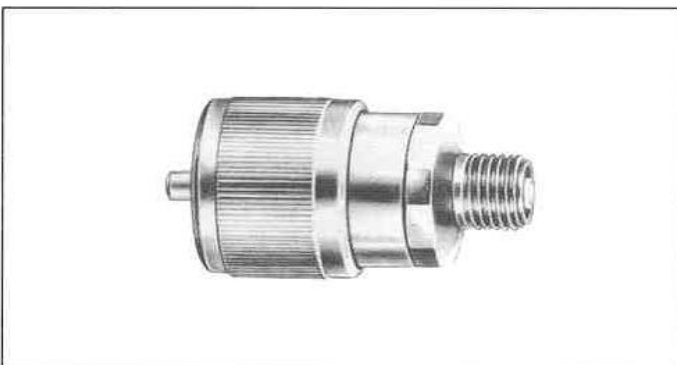

TYPE 157/8 SERIES 100 FEMALE CONTACT U.H.F. 83 MALE PIN

Part Number	Description	Weight
501320-000-01	157/8 Adaptor	48.3 gm 1.70 oz

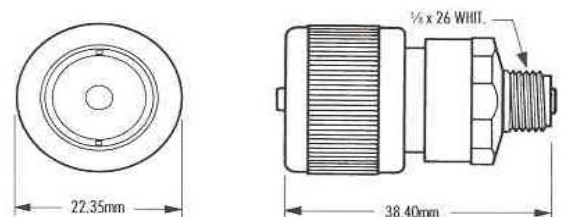

CONNECTORS **SERIES 100**

SERIES ADAPTORS

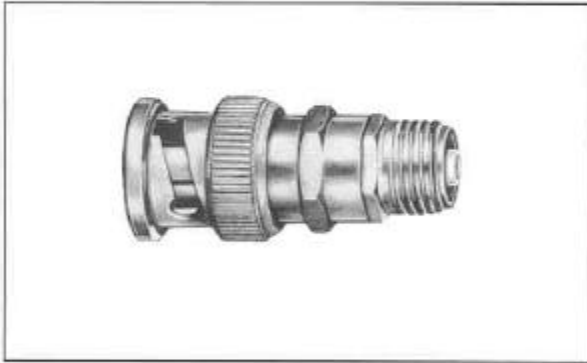

TYPE 157/11 SERIES 100 FEMALE CONTACT B.N.C. MALE PIN

Part Number	Description	Weight	
557050-000-111	157/11 Adaptor	15.5 gm	0.55 oz

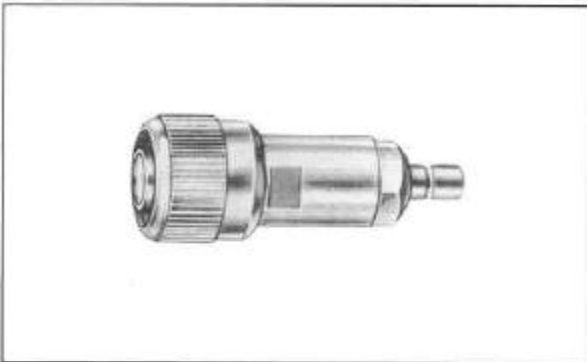
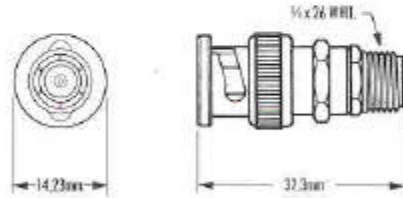

TYPE 157/12 SERIES 100 MALE PIN S.M.B. MALE PIN

Part Number	Description	Weight	
551403-000-111	157/12 Adaptor	12.0 gm	0.43 oz

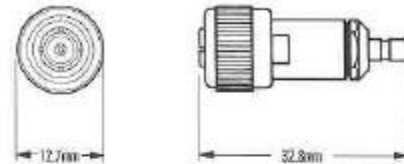

PROTECTIVE CAPS

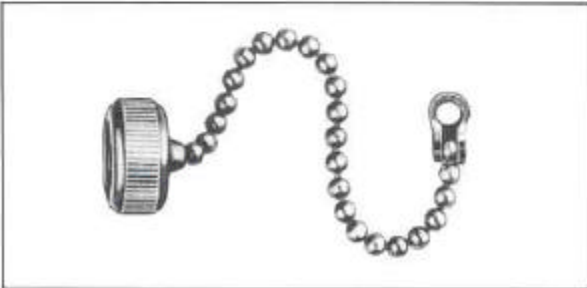

TYPE 171 SCREW ON CAPTIVE

Part Number	Description	Weight	
551171-000-011	171/BMP/Pro-Cap	5.0 gm	0.18 oz

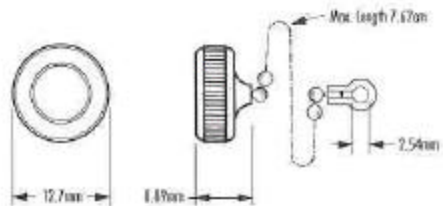

TYPE 179 PUSH ON NON CAPTIVE

Part Number	Description
301179-001	179/POLY/Pro-Cap

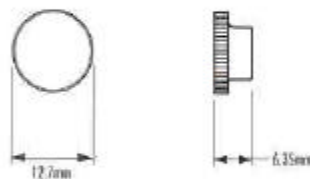

TYPE 178 PUSH ON NON CAPTIVE

Part Number	Description
301178-001	178/POLY/Pro-Cap

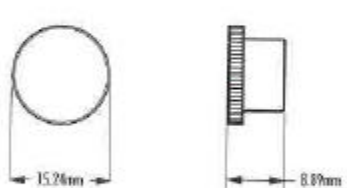

These protective caps are suitable for connector types:
101 102 156

These protective caps are suitable for connector types:
111 121 122 131 132 141 142 151 152 156

X-ON Electronics

Largest Supplier of Electrical and Electronic Components

Click to view similar products for te connectivity manufacturer:

Other Similar products are found below :

[570416-000](#) [CLTEQ-M81CE-SSRELAY-4-20V](#) [D38999/24FJ4AN](#) [358838-000](#) [4-1195131-0](#) [650069-000](#) [SMD100-2](#) [CB-1022B-78](#)
[RM707012](#) [RP410012](#) [MMS42](#) [1-640426-8](#) [2EDL4CM](#) [DTS20W19-11PD-3028-LC](#) [RM202615](#) [NC6-P104-06](#) [TXR64AB90-3616AI](#)
[MSPS103B](#) [DTS26F21-41AE](#) [DTS26F21-41PE-LC](#) [DTS26F21-11SE-3028-LC](#) [1932144-1](#) [293545-4](#) [LVR125S](#) [MS27466T25F4PB](#) [CKB-](#)
[38-78010](#) [1206SFF150F/63-2](#) [5-2027513-8](#) [D38999/20JB35HA](#) [D38999/24WJ20PA](#) [1754138-1](#) [TE1500A2R2J](#) [DTS24F25-29PC-3028-LC](#)
[164-8033-08](#) [D38999/24WG11HA](#) [D38999/24WG11HN](#) [MS27467T21F11H](#) [DJT16E21-11HA](#) [1206SFH150F/24-2](#) [1-532955-3](#) [DTS24F19-](#)
[11SC-3028-LC](#) [DTS24F21-41HN-LC](#) [DTS24F21-41AN](#) [DTS24F21-41PN-LC](#) [DBAS 70-7-0 SN 090-1A SCC](#) [MS27467T21F35J](#)
[MS27467T21F11J](#) [MS27467T21F16H-LC](#) [MS27467T21F35H](#) [MS27467T21F41H-LC](#)