

1.5mm Side Looking Phototransistor EAPLP04RRKA1

Features

- Fast response time
- High sensitivity
- Small junction capacitance
- Pb Free
- This product itself will remain within RoHS compliant version.

Description

- EAPLP04RRKA1 is a phototransistor in miniature package which is molded in a water clear plastic with spherical top view lens. The device is spectrally matched to infrared emitting diode.

Applications

- Optoelectronic switch
- VCR , Video Camera
- Floppy disk drive
- Infrared applied system

Device Selection Guide

Chip Materials	Lens Color
Silicon	water clear

Absolute Maximum Ratings (Ta=25°C)

Parameter	Symbol	Rating	Unit
Collector-Emitter Voltage	V_{CEO}	30	V
Emitter-Collector-Voltage	V_{ECO}	5	V
Collector Current	I_C	40	mA
Operating Temperature	T_{opr}	-25~+85	°C
Storage Temperature	T_{stg}	-40~ +100	°C
Lead Soldering Temperature	T_{sol}	260	°C
Power Dissipation at (or below) 25°C Free Air Temperature	P_c	75	mW

Notes: *1: Soldering time \leq 5 seconds.

Electro-Optical Characteristics (Ta=25°C)

Parameter	Symbol	Min.	Typ.	Max.	Unit	Condition
Collector – Emitter Breakdown Voltage	BV_{CEO}	30	-----	-----	V	$I_C=100\mu A$ $E_e=0mW/cm^2$
Emitter-Collector Breakdown Voltage	BV_{ECO}	5	-----	-----	V	$I_E=100\mu A$ $E_e=0mW/cm^2$
Collector-Emitter Saturation Voltage	$V_{CE(sat)}$	-----	-----	0.4	V	$I_C=2mA$ $E_e=1mW/cm^2$
Rise Time	t_r	-----	15	-----	μS	$V_{CE}=5V$ $I_C=1mA$ $RL=1000\Omega$
Fall Time	t_f	-----	15	-----		
Collector Dark Current	I_{CEO}	-----	-----	100	nA	$E_e=0mW/cm^2$ $V_{CE}=20V$
On State Collector Current	$I_{C(on)}$	0.53	-----	3.41	mA	$E_e=0.555mW/cm^2$ $V_{CE}=5V$
Rang Of Spectral Bandwidth	$\lambda_{0.5}$	400	-----	1200	nm	----
Wavelength of Peak Sensitivity	λ_P	-----	940	-----	nm	----

Ranks

Parameter	Symbol	Min	Max	Unit	Test condition
7-3	$I_{C(ON)}$	0.53	1.19	mA	$V_{CE}=5V$ $E_e=0.555mW/cm^2$
7-2		0.88	1.70		
7-1		1.24	2.21		
6-2		1.59	2.98		
6-1		1.77	3.41		

Typical Electro-Optical Characteristics Curves

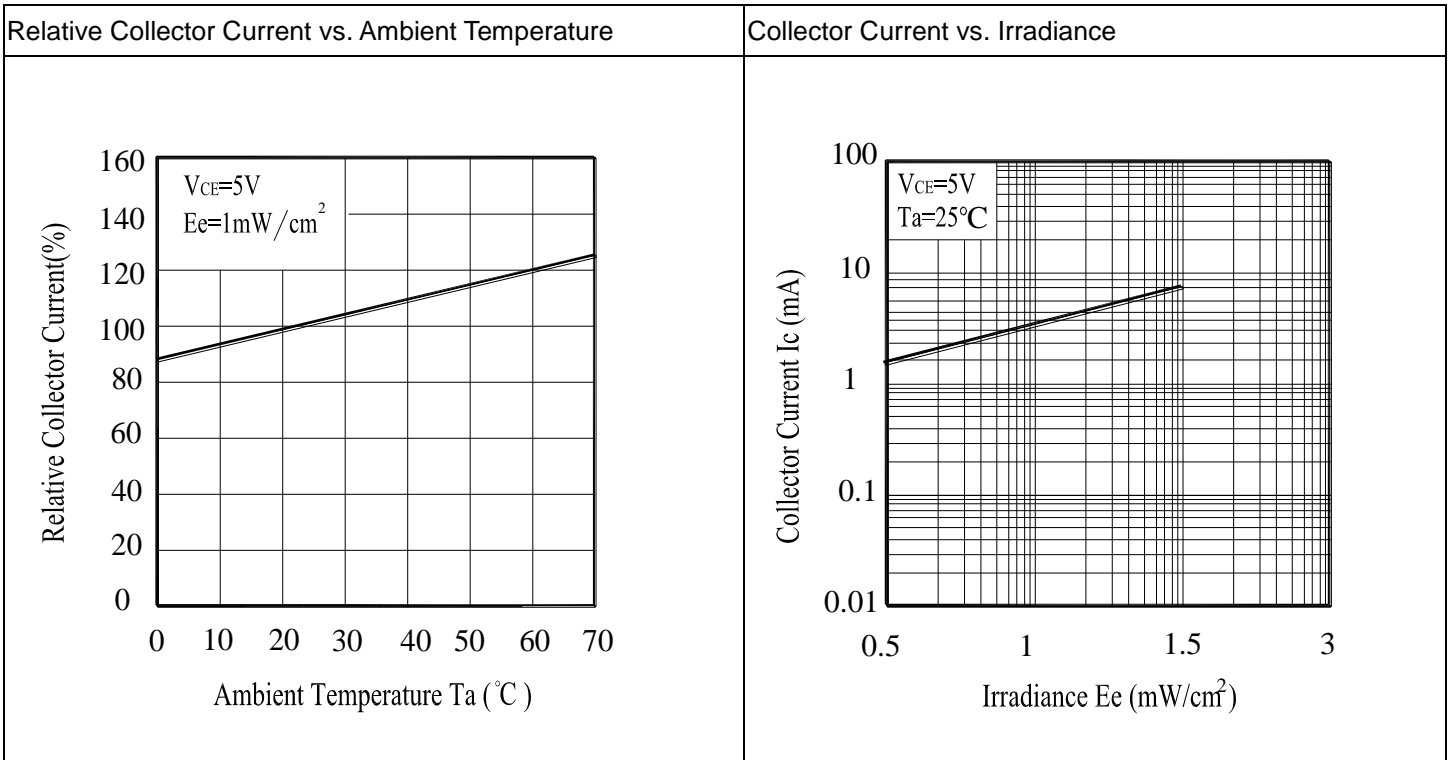
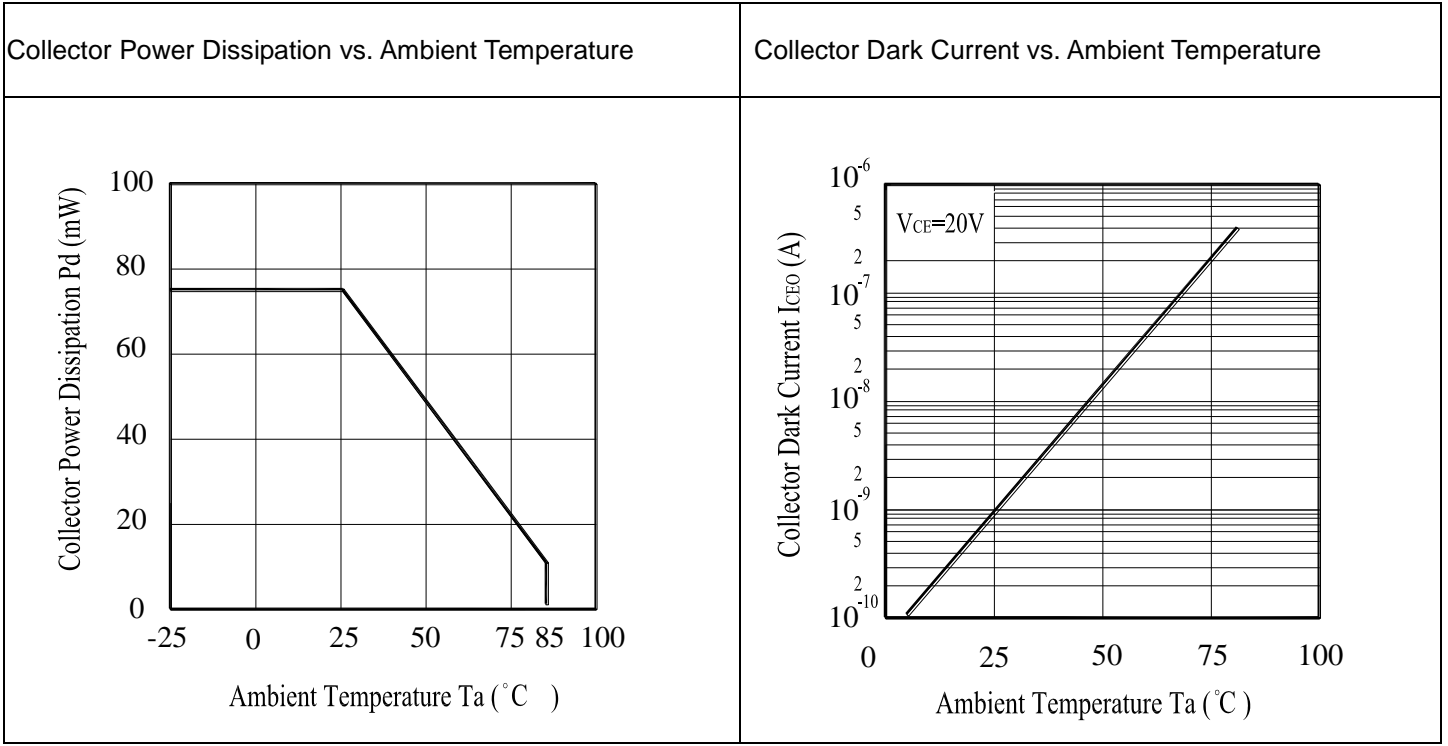

Spectral Sensitivity

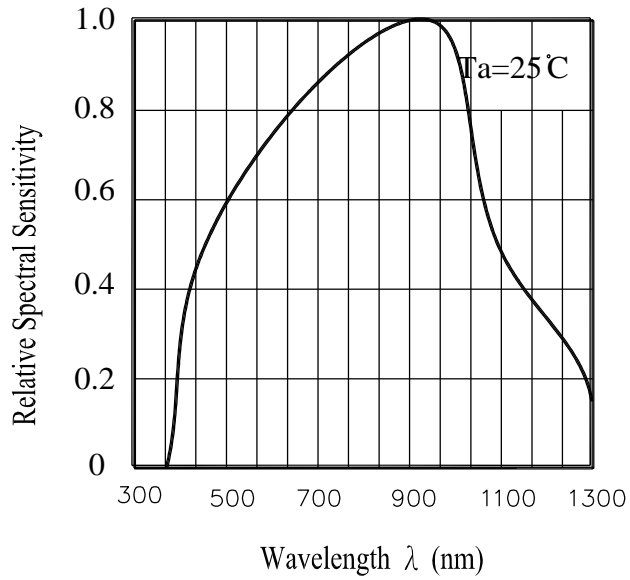

Collector Current vs. Collector-Emitter Voltage

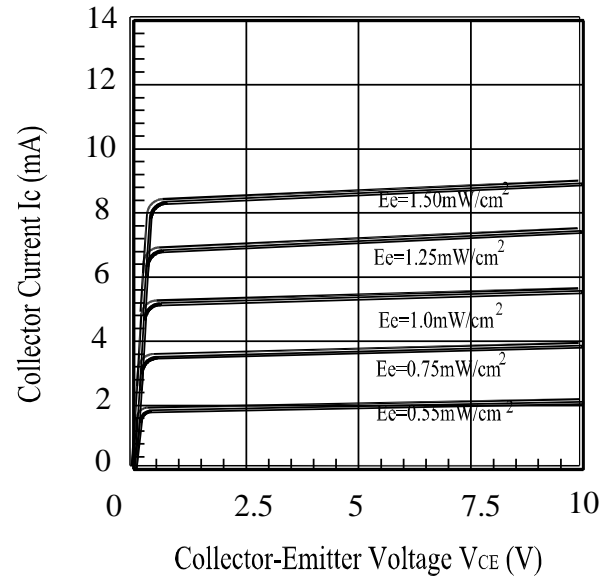

Test method

Light current test method for PT:

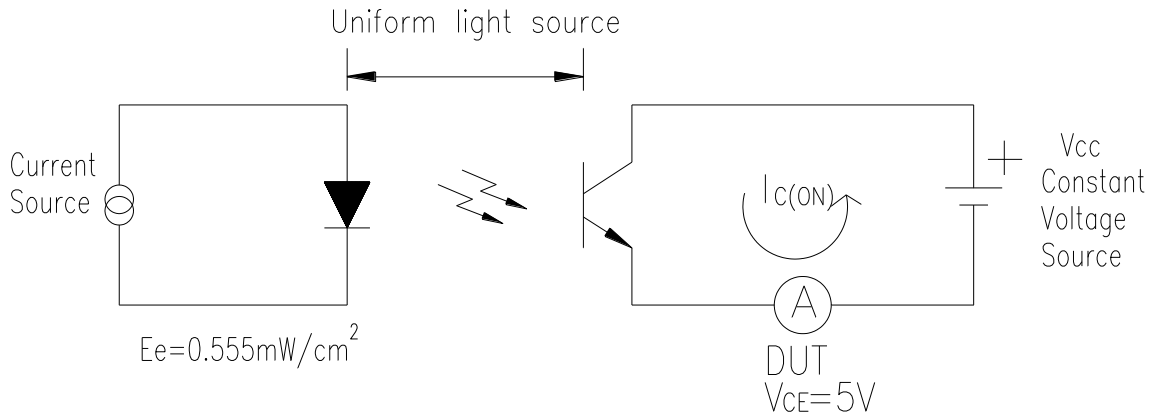

Package Dimension

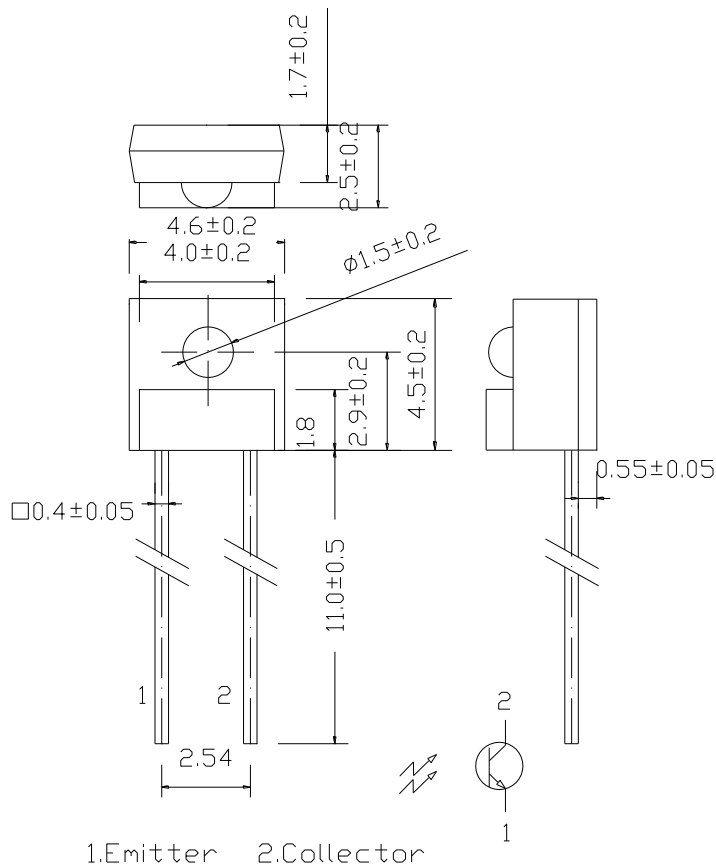

Note: Tolerances unless dimensions $\pm 0.25\text{mm}$

Packing Quantity Specification

1. 1000PCS/1Bag,10Bags/1Box
2. 10Boxes/1Carton

Label Explanation

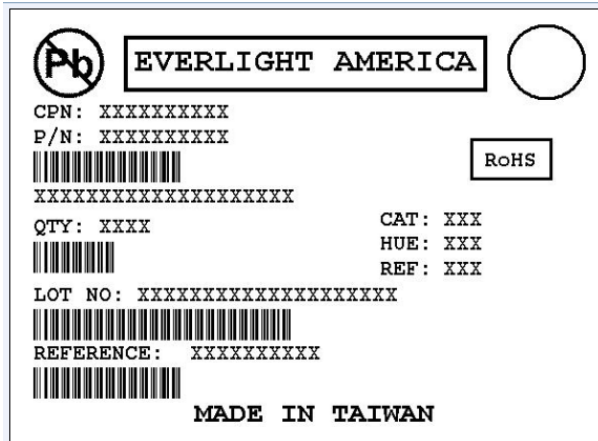

- CPN: Customer's Product Number
- P/N: Product Number
- QTY: Packing Quantity
- CAT: Luminous Intensity Rank
- HUE: Dom. Wavelength Rank
- REF: Forward Voltage Rank
- LOT No: Lot Number
- X: Month
- Reference: Identify Label Number

Notes

1. Above specification may be changed without notice. EVERLIGHT Americas will reserve authority on material change for above specification.
2. When using this product, please observe the absolute maximum ratings and the instructions for using outlined in these specification sheets. EVERLIGHT Americas assumes no responsibility for any damage resulting from use of the product which does not comply with the absolute maximum ratings and the instructions included in these specification sheets.
3. These specification sheets include materials protected under copyright of EVERLIGHT Americas corporation. Please don't reproduce or cause anyone to reproduce them without EVERLIGHT's Americas consent.

X-ON Electronics

Largest Supplier of Electrical and Electronic Components

Click to view similar products for [Phototransistors](#) category:

Click to view products by [Everlight](#) manufacturer:

Other Similar products are found below :

[QSD123A4R0](#) [ASDL-6620-C22](#) [OED-ST-8LR2](#) [OED-STR44B90-TR](#) [IDCHIP001](#) [PT-A1-AC-3-PE-850](#) [PT-A1-AC-3528-850](#) [PT-A1-AC-5-HE-850](#) [PT-A1-DC-5-BN-940](#) [PT-A1-FC-5-BE-940](#) [PT-A2-AC-3-BE-850](#) [PT-A2-AC-5-BE-850](#) [PT-A2-AC-5-PE-850](#) [PT-A2-AC-5-PN-850](#) [PT-A2-DC-3-BE-940](#) [PT-A4-AC-5-PN-850](#) [PT-A6-AC-5-BN-520](#) [PT-A6-AC-5-PN-520](#) [PT-A8-AC-1206-850](#) [PT-B1-DC-0603-940](#) [PT-IC-AC-3-PE-550](#) [PT-IC-AC-5-BN-520](#) [PT-IC-AC-5-PE-550](#) [PT-IC-AC-5-PN-520](#) [PT-IC-BC-3-PE-550](#) [PT-IC-BC-5-PE-550](#) [140814240010](#) [140814241110](#) [140814240110](#) [140814241010](#) [140817141010](#) [140817140410](#) [140817140010](#) [140817141410](#) [140817140110](#) [140817140210](#) [140817140310](#) [140817141210](#) [140817141110](#) [140817141310](#) [140356145200](#) [140356145300](#) [140814242100](#) [140814242000](#) [140814243000](#) [140354245000](#) [140356145400](#) [140356145000](#) [140814243100](#) [140354245100](#)