

ENERGIZER NO. E96

AAAA

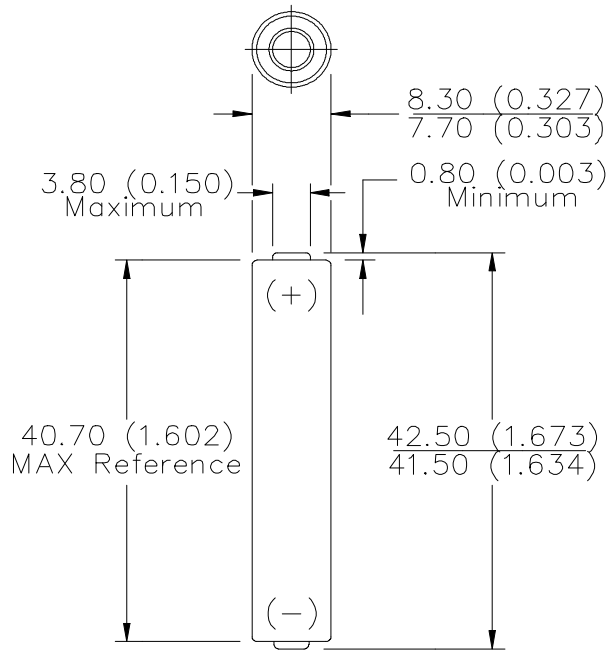

Industry Standard Dimensions in mm (inches)



Chemical System: Alkaline
 Zinc-Manganese Dioxide (Zn/MnO₂)
 (No Added Mercury or Cadmium)

Designation: ANSI-25A

Battery Voltage: 1.5 Volts

Operating Temp: -18°C to 55°C (0°F to 130°F)

Average Capacity: 625 mAh (to 0.8 volts)
 (Rated capacity at 25 mA continuous drain.)

Average Weight: 6.5 grams (0.2 oz.)

Volume: 2.2 cubic centimeters (0.1 cubic inch)

Cell: One No. 3-0316 (size 'AAAA')

Jacket: Plastic Label

Shelf Life: 7 years (80% of rated capacity)

TEMPERATURE EFFECTS
 Typical Service to 0.8 Volts

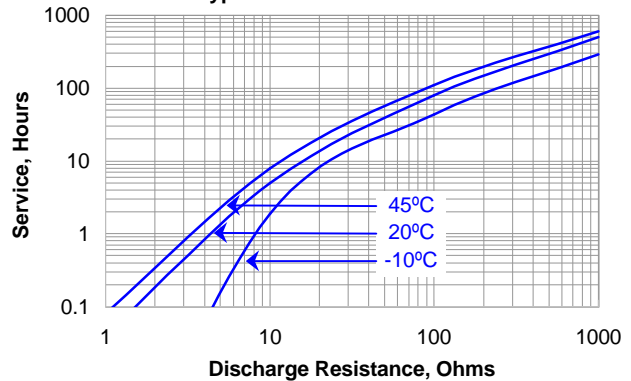

CONSTANT RESISTANCE PERFORMANCE
 Typical Service

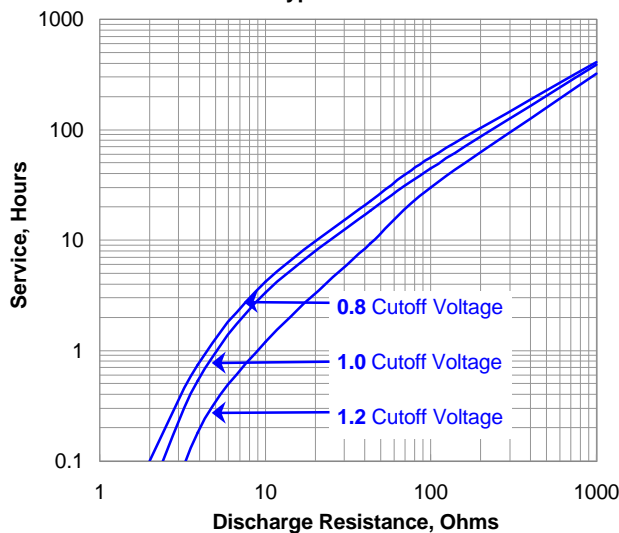

CONSTANT CURRENT DISCHARGE
 Typical Service

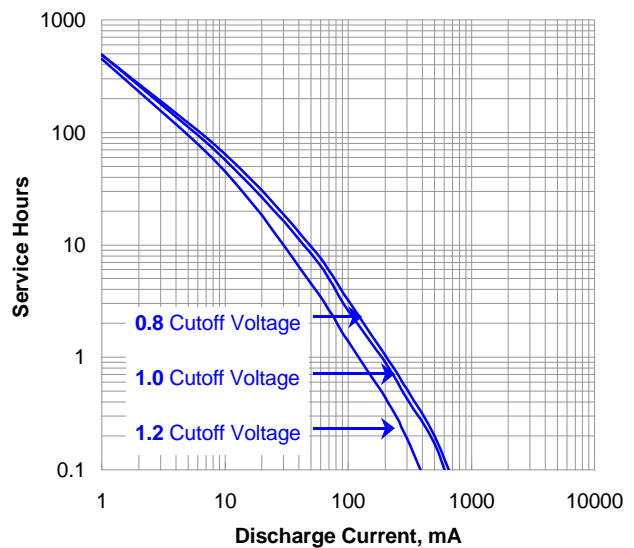

Important Notice

This data sheet contains information specific to batteries manufactured at the time of its publication.

Contents herein do not constitute a warranty.

Copyright © Eveready Battery Co. - All rights reserved

ENERGIZER NO. E96

**CONSTANT POWER DISCHARGE
250 mW - Typical Service**

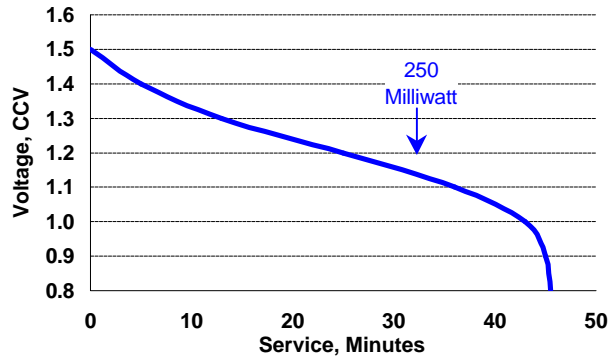

ANSI - IEC Industry Standard Tests @ 20° C

**LASER POINTER
75 ohm - 1 hour/day**

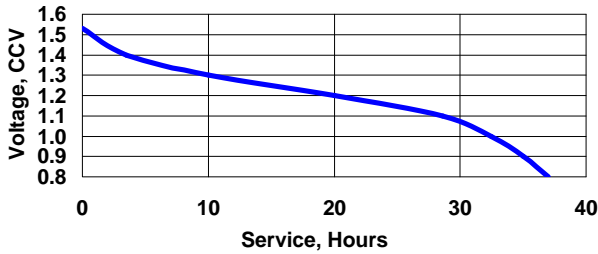

**LIGHTING
5.1 ohm - 5 min/day**

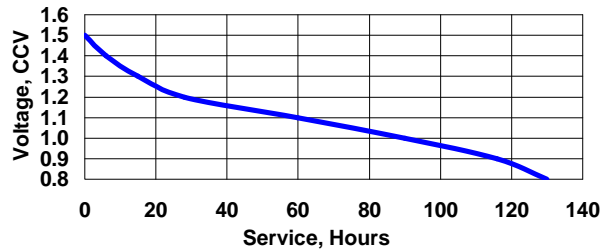

**SERVICE OUTPUT
75 ohm - 1 hr/day**

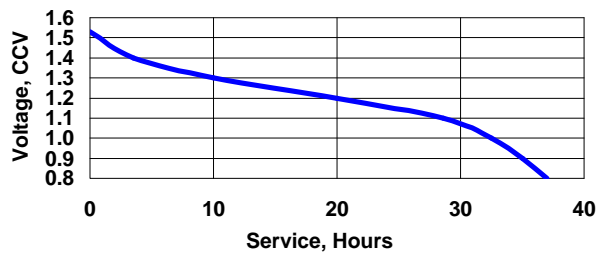

Important Notice

This data sheet contains information specific to batteries manufactured at the time of its publication.

Contents herein do not constitute a warranty.

Copyright © Eveready Battery Co. - All rights reserved

X-ON Electronics

Largest Supplier of Electrical and Electronic Components

Click to view similar products for [energizer manufacturer](#):

Other Similar products are found below :

[1215F2X3](#) [E11A B2](#) [LR43 186](#) [AC13](#) [AC675](#) [3LR12](#) [603298](#) [625302](#) [625304](#) [638006](#) [639830](#) [S9025](#) [7638900426687](#) [7638900414660](#)
[E92 MAX](#) [E91 MAX](#) [HARD CASE RECHARGEABLE](#) [HARD CASE PRO MULTI USE](#) [HCHD311](#) [S9029](#) [639826](#) [603386](#) [HARD CASE](#)
[PROFF 4AA](#) [HARDCASE PRO HEADLIGHT](#) [639618](#) [RCLINM2WR](#) [S8865](#) [S8707](#) [S8100](#) [7638900424478](#) [7638900313130](#) [626177](#)
[E300116200](#) [639838](#) [HARDCASE PRO WORK LIGHT](#) [603305](#) [E300280600](#) [METAL LED 6AA](#) [S8864](#) [HDD32E](#) [MS2AALED](#)
[ENERGIZERÂ® 2-IN-1 LANTERN HANDHELD](#) [E300124200](#) [E300171700](#) [ENFFL81E](#) [E300112600](#) [633474](#) [HDA32E](#) [7638900421422](#)
[HARD CASE PRO PIVOT](#)