

ENERGIZER E93

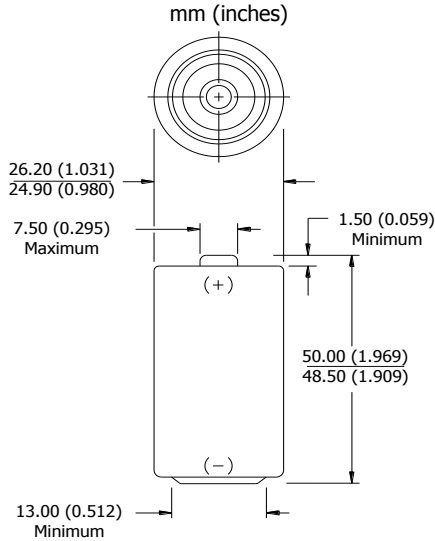

Industry Standard Dimensions



**Reversal Protection:
Non-Conductive Area**

Specifications

Classification:	Alkaline
Chemical System:	Zinc-Manganese Dioxide (Zn/MnO ₂) No added mercury or cadmium
Designation:	ANSI-14A, IEC-LR14
Nominal Voltage:	1.5 volts
Nominal IR:	150 to 300 milliohms (fresh)
Operating Temp:	-18°C to 55°C (0°F to 130°F)
Typical Weight:	66.2 grams (2.3 oz.)
Typical Volume:	26.9 cubic centimeters (1.6 cubic inch)
Jacket:	Plastic Label
Shelf Life:	10 years at 21°C
Terminal:	Flat Contact
Manufactured:	Made in the USA

Milliamp-Hours Capacity

Continuous discharge to 0.8 volts at 21°C

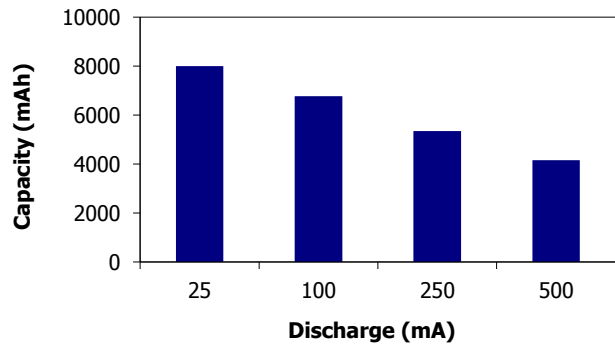

Constant Power Performance

Typical Characteristics (21°C) to 0.9 Volts

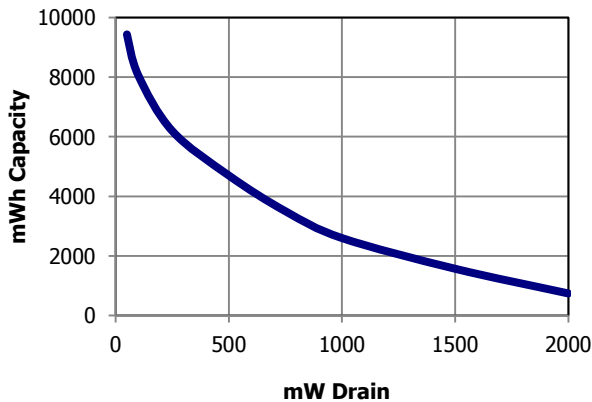

Constant Current Performance

Typical Characteristics (21°C) to 0.9 Volts

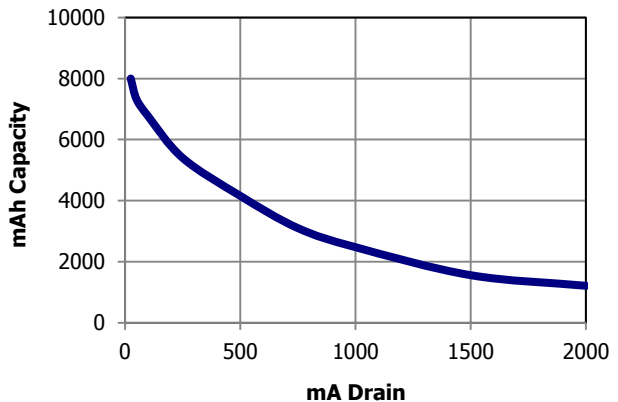

Important Notice

This data sheet contains typical information specific to products manufactured at the time of its publication.
©Energizer Holdings, Inc. - Contents herein do not constitute a warranty.

ENERGIZER E93



Industry Standard Tests (21°C)

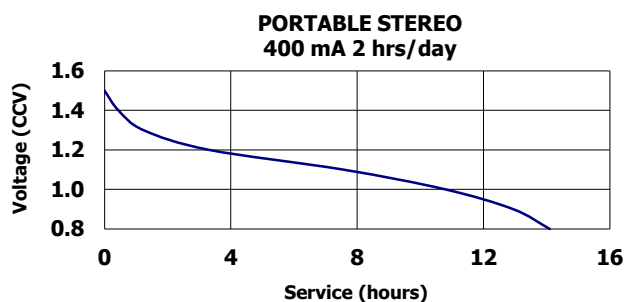
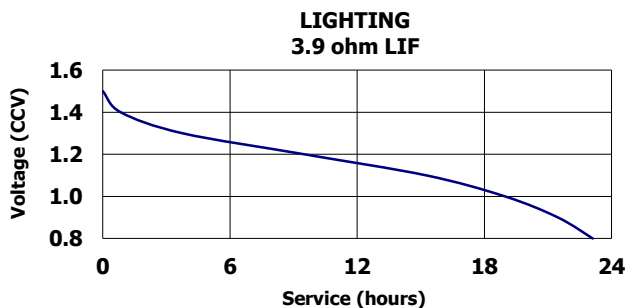
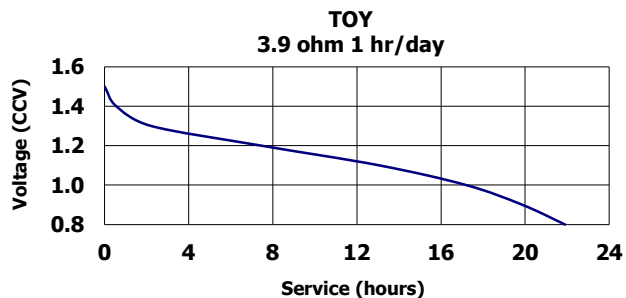

Important Notice

This data sheet contains typical information specific to products manufactured at the time of its publication.
©Energizer Holdings, Inc. - Contents herein do not constitute a warranty.

X-ON Electronics

Largest Supplier of Electrical and Electronic Components

Click to view similar products for [energizer manufacturer](#):

Other Similar products are found below :

[1215F2X3](#) [E11A B2](#) [LR43 186](#) [AC13](#) [AC675](#) [3LR12](#) [603298](#) [625302](#) [625304](#) [638006](#) [639830](#) [S9025](#) [7638900426687](#) [7638900414660](#)
[E92 MAX](#) [E91 MAX](#) [HARD CASE RECHARGEABLE](#) [HARD CASE PRO MULTI USE](#) [HCHD311](#) [S9029](#) [639826](#) [603386](#) [HARD CASE](#)
[PROFF 4AA](#) [HARDCASE PRO HEADLIGHT](#) [639618](#) [RCLINM2WR](#) [S8865](#) [S8707](#) [S8100](#) [7638900424478](#) [7638900313130](#) [626177](#)
[E300116200](#) [639838](#) [HARDCASE PRO WORK LIGHT](#) [603305](#) [E300280600](#) [METAL LED 6AA](#) [S8864](#) [HDD32E](#) [MS2AALED](#)
[ENERGIZERÂ® 2-IN-1 LANTERN HANDHELD](#) [E300124200](#) [E300171700](#) [ENFFL81E](#) [E300112600](#) [633474](#) [HDA32E](#) [7638900421422](#)
[HARD CASE PRO PIVOT](#)