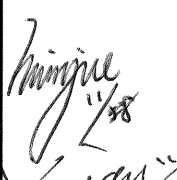
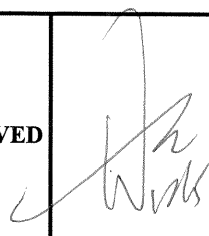

SUNON

SPECIFICATION FOR APPROVAL

CUSTOMER :
DESCRIPTION : AC BLOWER
DIMENSIONS : 120X120X31 mm
MODEL : AB1123-HST
P/N : GN
SUNON SPEC. NO. : A12004400G-00
APPROVAL NO. :
APPROVED BY :

(AUTHORIZED)

DRAWN	Cherry 11/23	CHECKED		APPROVED		SPEC.NO	A12004400G-00
						ISSUE DATE	11.23.2005
						EDITION	0
						REVISION DATE	
						E.SPEC	EA12137

建準電機工業股份有限公司

SUNONWEALTH ELECTRIC MACHINE INDUSTRY CO., LTD.

12FL., 120 CHUNG CHENG 1ST RD.,

KAOSIUNG, TAIWAN, R. O. C.

TEL:886-7-7163069(41 LINES)

FAX:886-7-7163086~89

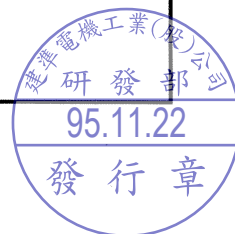

AXIAL AC FAN
MODEL : AB1123-HST
P/N : GN

CHARACTERISTICS

- 1. Motor Design** : **Reliable Shaded-Pole Motor Construction.**
- 2. Insulation Resistance** : **500Megohms minimum at 500 VDC.**
- 3. Dielectric Strength** : **1800 VAC for one second .**
- 4. Motor Protection** : **Impedance protected.**
- 5. Noise Level** : **Measured in a semi-anechoic chamber**
with background noise level below 15
dB(A). The fan is running in free air with the
microphone at a distance of one meter
from the fan intake.
- 6. Tolerance** : **±15% on rated power and current.**
- 7. Air Performance** : **Measured by a double chamber. The values**
are recorded when the fan speed has stabilized
at rated voltage.

建準電機工業股份有限公司 SUNONWEALTH ELECTRIC MACHINE INDUSTRY CO., LTD.	SPEC.NO	A12004400G-00	REVISION DATE	
	ISSUE DATE	11. 23. 2005	E D I T I O N	0
	P A G E	2 O F 9		



SPECIFICATIONS

MODEL: AB1123-HST

P/N : GN

- 1-1. Rated Voltage : 115 VAC 50/60 HZ**
- 1-2. Operating Voltage Range : 75-125 VAC**
- 1-3. Starting Voltage : 75 VAC (25 deg. C POWER ON/OFF)**
- 1-4. Rated Speed : 2600/2900 RPM ± 10%**
- 1-5. Air Delivery : 20/22 CFM**
- 1-6. Static Pressure : 0.32/0.46 Inch-H₂O**
- 1-7. Rated Current : 0.25/0.21 AMP**
- 1-8. Rated Power : 20/18 WATTS**
- 1-9. Noise Level : 48/50 dB(A)**
- 1-10. Direction of Rotation : clockwise viewed from front of fan blade**
- 1-11. Operating Temperature : -10 to +70 deg. C**
- 1-12. Storage Temperature : -40 to +70 deg. C**
- 1-13. Bearing System : Lubricated sleeve bearing system**
- 1-14. Weight : 678 g**
- 1-15. Safety : UL/CUR/TUV/CE Approvals**
- 1-16. Vibration : Vibration of acceleration 1.5G and frequency 5~50~5Hz is applied in all 3 directions(X,Y,Z), in cycles of 1 minute each, for a total vibration time of 30 minutes.**
- 1-17. Protection : Automatic Restart Capability**
 Note: In a situation where the fan is locked by an external force while the electricity is on, an increase in coil temperature will be prevented by temporarily turning off the electrical power to the motor. The fan will automatically restart when the locked rotor condition is released.
Polarity Protection

建準電機工業股份有限公司
**SUNONWEALTH ELECTRIC
 MACHINE INDUSTRY CO., LTD.**

SPEC.NO	A12004400G-00	REVISION DATE	
ISSUE DATE	11. 23. 2005	E D I T I O N	
P A G E	3 OF 9		

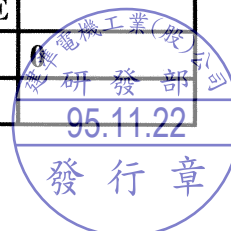

MODEL : AB1123-HST

P/N : GN

PERFORMANCE CURVES

STATIC
PRESSURE

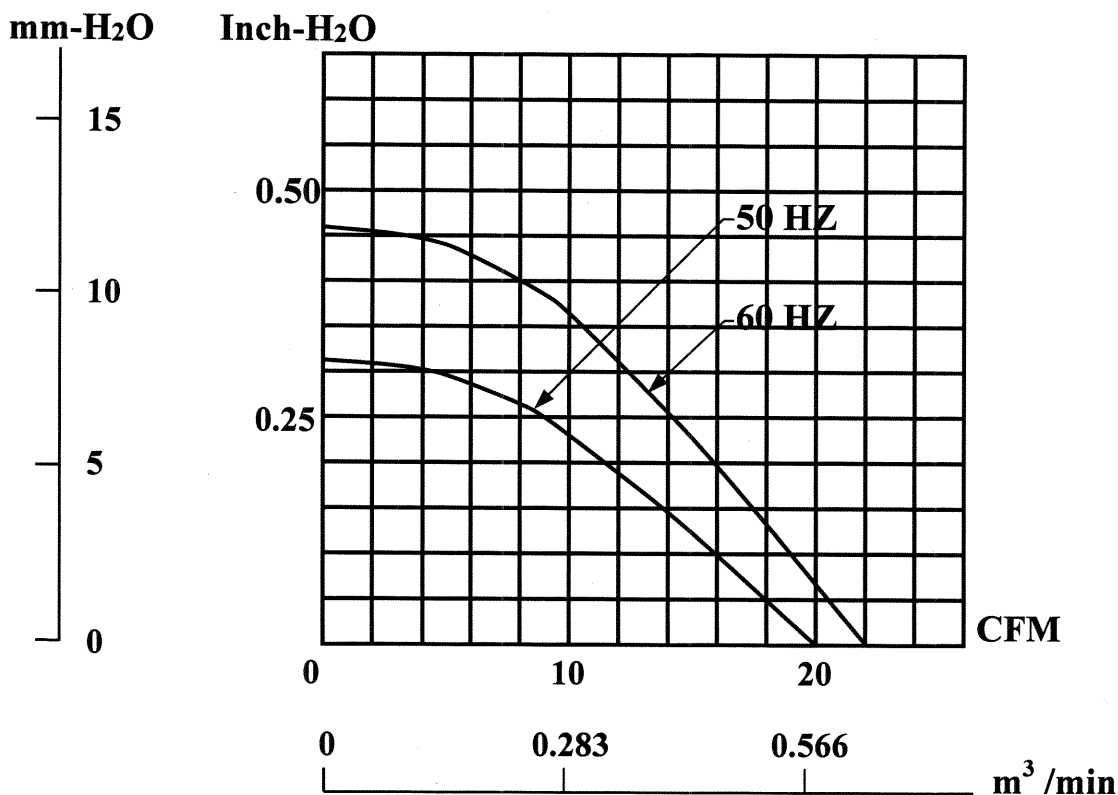

建準電機工業股份有限公司 SUNONWEALTH ELECTRIC MACHINE INDUSTRY CO., LTD.	SPEC.NO	A12004400G-00	REVISION DATE	
	ISSUE DATE	11. 23. 2005	EDITION	0
	PAGE	4 OF 9		



MATERIAL

2. Material

2-1. Frame : **DIE-CAST ALUMINUM**

2-2. Impeller : **Thermoplastic PBT of UL 94V-0**

DIMENSIONS

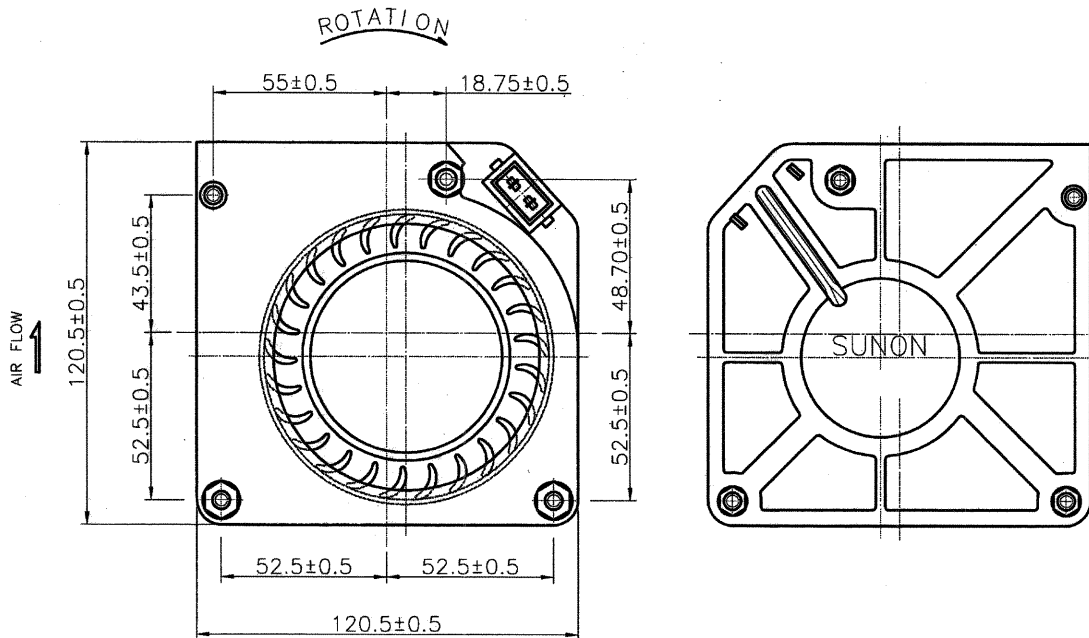
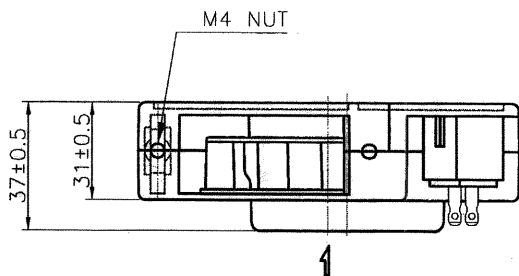

1. One directional exhaust

2. The Best Mounting Direction: Fan blade face up or shaft horizontal direction.

UNITS: mm

建準電機工業股份有限公司
SUNONWEALTH ELECTRIC
MACHINE INDUSTRY CO., LTD.

SPEC.NO	A12004400G-00	REVISION DATE	
ISSUE DATE	11. 23. 2005	EDITION	0
PAGE	5 OF 9		

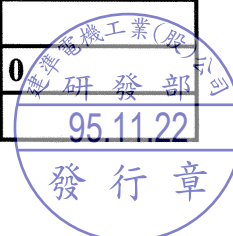

Notes

I . Safety

- 1.SUNON will not guarantee this product if your application exceeds the limitations outlined in this specification.
- 2.For the product without thermo-protector installed, such as thermo-fuse, or current-fuse or thermo-protector. There may be smoking, ignition, or electric shock by insulation degradation in cases of motor lock, motor lead short circuit, overload, over voltage, and/or other failure. Please add the protection circuit to your product.
- 3.For the product without reverse-connection prevention diode of VDC (+) and GND (-) installed. If VDC(+) and GND(-) are reverse connected, it may cause smoking, ignition, and/or destruction, although these conditions may not manifest immediately. We recommend that a protection device be installed on your product when there is a possibility of reverse-connection.
- 4.Please verify that this product is being installed and used in compliance with all safety standards. Please inform SUNON of any safety concerns prior to releasing your product to production.
- 5.Please handle and install this product carefully. Hitting or dropping this product may cause damage.
- 6.Please do not damage this product including coil and lead wires while installing or wiring. There may be smoking or fire.
- 7.Sunon doesn't suggest customers to use power or ground PWM to control the fan speed, if necessary, we need to do the special design for the application.

建準電機工業股份有限公司 SUNONWEALTH ELECTRIC MACHINE INDUSTRY CO., LTD.	SPEC.NO	A12004400G-00	REVISION DATE	
	ISSUE DATE	11. 23. 2005	E D I T I O N	0
	P A G E	6 O F 9		

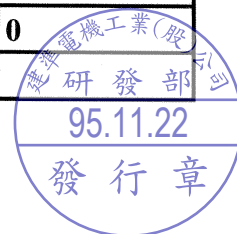

Notes

II .Specification modification

- 1.SUNON offers engineering assistance on fan installation and cooling system design.
- 2.Any change to the parameters specified in this document will be determined by mutual agreement between both parties. Parameters which are not specified in this specification will be identical to the final sample which has been approved by your company.
- 3.Product will be shipped in accordance with this specification unless Sunon has been previously notified of parameters requiring exception.
- 4.Parameters modified by mutual consent will be incorporated in this specification.
- 5.Please notify SUNON in advance of any modification to your product or new application for this fan which may require a review of this specification.

建準電機工業股份有限公司 SUNONWEALTH ELECTRIC MACHINE INDUSTRY CO., LTD.	SPEC.NO	A12004400G-00	REVISION DATE	
	ISSUE DATE	11. 23. 2005	E D I T I O N	0
	P A G E	7 O F 9		



Notes

III . Other

1. When building your device, please examine thoroughly any variation of EMC, temperature rise, life data, quality, etc. of this product by shock/drop/vibration testing, etc. If there are any problems or accidents in connection with this product, it should be mutually discussed and examined.
2. Fan holders or bearings may be damaged if touched with fingers or other objects. Additionally, static electricity (ESD) may damage the internal circuits. Please handle this product carefully.
3. Please avoid operating SUNON's product in poisonous material (organic silicon, cyanogens, formalin, phenol, etc.) or corrosive gas environments (H₂S, SO₂, NO₂, Cl₂, etc).
4. SUNON does not warrant performance safety against accidents caused by dust, water, droplets, dew, bugs, etc.
5. Please advise us in advance if you require documents for export.
6. Improper mounting may cause harsh resonance, vibration, and noise. Please mount securely.
7. Safety is a top priority. Please furnish guard accessories to prevent injury to personnel.
8. Unless otherwise noted, all tests are conducted at 25°C ambient temperature and 65% relative humidity.
9. Always ensure that fans are stored according to the storage temperatures specified. Do not store in a high humidity environment. If the fans are stored for more than 6 months, SUNON recommends functional testing before using.
10. SUNON reserves the right to use components with equivalent specifications from multiple sources.

建準電機工業股份有限公司 SUNONWEALTH ELECTRIC MACHINE INDUSTRY CO., LTD.	SPEC.NO	A12004400G-00	REVISION DATE	
	ISSUE DATE	11. 23. 2005	E D I T I O N	0
	P A G E	8 O F 9		



Declaration of RoHS

Control declaration of environment-related substances/materials

1. In accordance with the Restriction of Hazardous Substances (RoHS) Directive, Sunon product with P/N: GN models have complied with law and discipline not to employ the forbidden substances, and restrict the allowable concentration of some limited substances deliberately in our components.

No	Substance	Criteria
1	Halogens & its compounds (Substances depleting the ozone layer)	Forbidden
2	Chlorinated Organic Solvent	Forbidden
3	Plastic (Frame, Impeller, wire harness, etc.)	< 100ppm
	Solder	< 1000ppm
	Iron Alloy	< 3500ppm
	Aluminium Alloy	< 4000ppm
	Copper Alloy	< 4wt%
4	Solder	< 20ppm
	Parts composed of metals containing zinc (e.g. brass, zinc for die casting)	< 100ppm
	Plastic	< 5ppm
5	PBB and PBDE Category	Forbidden
6	PCB and PCT Category	Forbidden
7	CP	Forbidden
8	Mirex	Forbidden
9	PCN category	Forbidden
10	Hexavalent Chromium Compounds	< 100ppm
11	Mercury and its compounds	Forbidden
12	Asbestos	Forbidden
13	Organic Tin Compounds	Forbidden
14	Azo Compounds	Forbidden

建準電機工業股份有限公司
SUNONWEALTH ELECTRIC
MACHINE INDUSTRY CO., LTD.

SPEC.NO	A12004400G-00	REVISION DATE	
ISSUE DATE	11. 23. 2005	E D I T I O N	0
P A G E	9 O F 9		



X-ON Electronics

Largest Supplier of Electrical and Electronic Components

Click to view similar products for [sunon](#) manufacturer:

Other Similar products are found below :

[MB50151V2-000U-A99](#) [3113HQ/MC40101V2-Q00U-S99](#) [UF3A3-700](#) [UB3H3-500](#) [PMB2475PNB3-AY.\(2\).GN](#) [KD1208PHB1.13.\(2\).GN](#)
[KD1204PKB3 \(2\).GN](#) [GB1205PKV2-8AY.F.GN](#) [EE60251B1-000U-C99](#) [3236HQ/PF40281B1-D17U-S99](#) [A2175HBT-TC.R.GN](#) [B2-10](#)
[SM203-13002](#) [PE80254V1-000U-A99](#) [PF92251V1-1000U-A99](#) [ME80201V2-000U-A99](#) [PE92252B1-000C-AB9](#) [MC30101V2-000C-](#)
[A99\(165mm\)](#) [MF20100V4-1Q04C-G99](#) [PE92254B2-000C-F99](#) [MC30150V1-000C-A99](#) [PE80252B1-000C-AB9](#) [MF20060V3-1Q07A-G99](#)
[MC25100V2-000C-G99](#) [PMD2412PMB1-A\(2\).R.GN.I55](#) [AB1123-HST.GN](#) [PF80381BX-000U-A99](#) [MF25100V1-1000U-A99](#) [PF80251V1-](#)
[1000U-F99](#) [PF92381B1-000U-A99](#) [VF40281BX-000U-A9H](#) [40HVH120M](#) [LA004-024A83DY](#) [SM203-14001Y](#) [MF80251V1-1000U-G99](#)
[EE60251B2-000U-999](#) [SM203-13004Y](#) [SM205-13001](#) [F92-B](#) [FG-8/45](#) [LA004-011A99DN](#) [SF11592A-1092HSL.GN](#) [CF4113HBL-000U-](#)
[ABD](#) [SF23092A-2092MBL.GN](#) [MF20100V1-1000U-A99](#) [DP203A-2123LBL.\(5\).GN](#) [PF40281B3-000U-A99](#) [LM310-001A99DN](#)
[KD2406PKB2.\(2\).GN](#) [MF30060V1-1000U-G99](#)