

Glass Passivated Single-Phase Bridge Rectifier

FEATURES

- Ideal for printed circuit board
- High case dielectric strength of 1500 VRMS
- High surge current capability
- Typical IR less than 0.1 μ A
- UL Recognized File # E-326243
- Compliant to RoHS Directive 2011/65/EU and in accordance to WEEE 2002/96/EC
- Halogen-free according to IEC 61249-2-21 definition

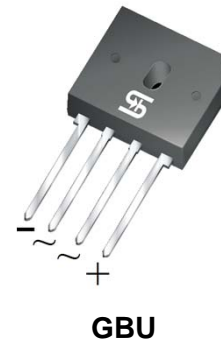

MECHANICAL DATA

Case: GBU

Molding compound, UL flammability classification rating 94V-0

Packing code with suffix "G" means green compound (halogen-free)

Terminal: Matte tin plated leads, solderable per JESD22-B102

Polarity: As marked

Weight: 4 g (approximately)

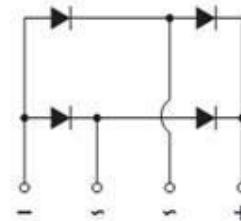

| MAXIMUM RATINGS AND ELECTRICAL CHARACTERISTICS (T _A =25°C unless otherwise noted) | | | | | | | | | |
|---|--|--------------|----------|----------|----------|----------|----------|----------|------------------|
| PARAMETER | SYMBOL | GBU 1001 | GBU 1002 | GBU 1003 | GBU 1004 | GBU 1005 | GBU 1006 | GBU 1007 | UNIT |
| Maximum repetitive peak reverse voltage | V _{RRM} | 50 | 100 | 200 | 400 | 600 | 800 | 1000 | V |
| Maximum RMS voltage | V _{RMS} | 35 | 70 | 140 | 280 | 420 | 560 | 700 | V |
| Maximum DC blocking voltage | V _{DC} | 50 | 100 | 200 | 400 | 600 | 800 | 1000 | V |
| Maximum average forward rectified current | I _{F(AV)} | 10 | | | | | | | A |
| Peak forward surge current, 8.3 ms single half sine-wave | I _{FSM} | 220 | | | | | | | A |
| Rating of fusing (t<8.3ms) | I ² t | 200 | | | | | | | A ² s |
| Maximum instantaneous forward voltage (Note 1) I _F = 5 A I _F = 10 A | V _F | 1.0 1.1 | | | | | | | V |
| Maximum reverse current @ rated VR T _J =25 °C T _J =125 °C | I _R | 5 500 | | | | | | | μ A |
| Typical junction capacitance per leg (Note 2) | C _j | 211 | | | | 94 | | | pF |
| Typical thermal resistance | R _{θJC} R _{θJA} | 2 21 | | | | | | | °C/W |
| Operating junction temperature range | T _J | - 55 to +150 | | | | | | | °C |
| Storage temperature range | T _{STG} | - 55 to +150 | | | | | | | °C |

Note 1: Pulse test with PW=300 μ s, 1% duty cycle

Note 2: Measured at 1MHz and applied Reverse bias of 4.0V DC

| ORDERING INFORMATION | | | | |
|----------------------|--------------|---------------------|---------|-----------|
| PART NO. | PACKING CODE | GREEN COMPOUND CODE | PACKAGE | PACKING |
| GBU100x (Note 1) | C2 | G | GBU | 20 / Tube |
| | D2 | | | 20 / Tube |
| | X0 | | | Forming |

Note 1: "x" defines voltage from 50V (GBU1001) to 1000V (GBU1007)

| EXAMPLE | | | | |
|---------------|----------|--------------|---------------------|----------------|
| PREFERRED P/N | PART NO. | PACKING CODE | GREEN COMPOUND CODE | DESCRIPTION |
| GBU1006 C2 | GBU1006 | C2 | | |
| GBU1006 C2G | GBU1006 | C2 | G | Green compound |

RATINGS AND CHARACTERISTICS CURVES

(T_A=25°C unless otherwise noted)

FIG. 1 MAXIMUM DERATING CURVE OUTPUT CURRENT

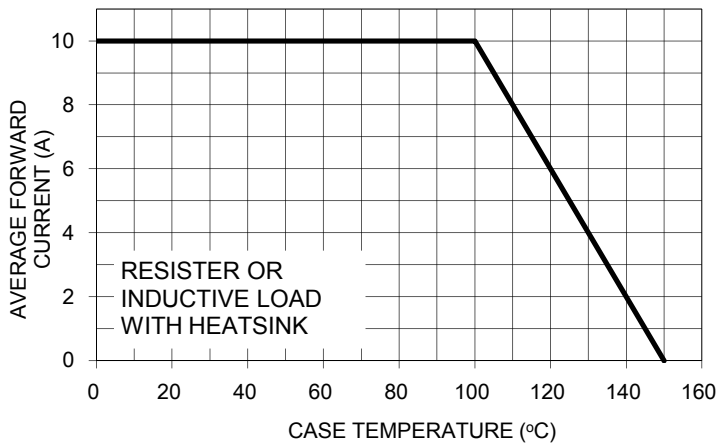

FIG. 2 MAXIMUM FORWARD SURGE CURRENT PER LEG

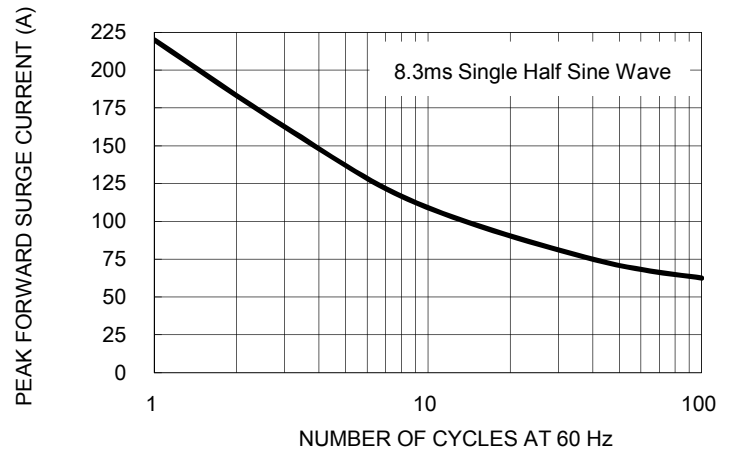

FIG. 3 TYPICAL REVERSE CHARACTERISTICS PER LEG

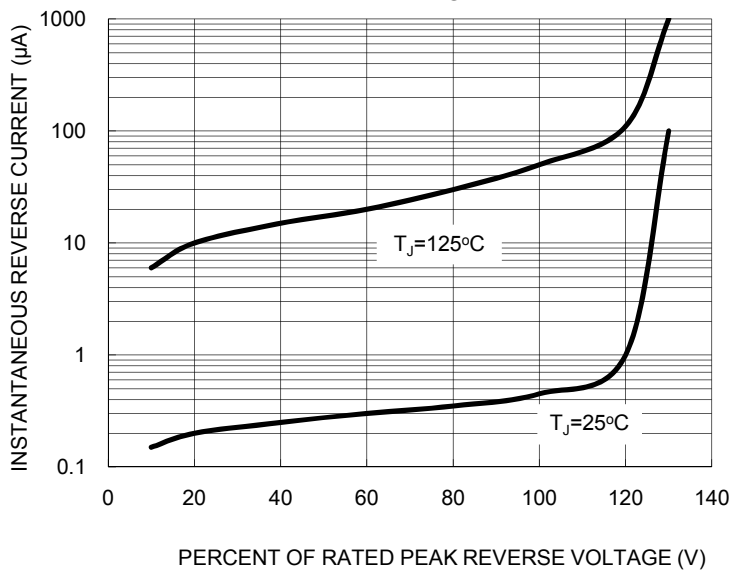

FIG. 4 TYPICAL FORWARD CHARACTERISTICS PER LEG

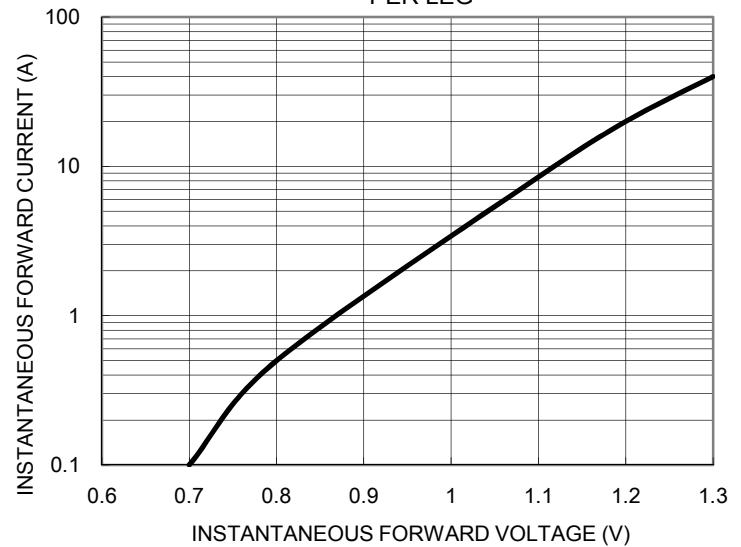
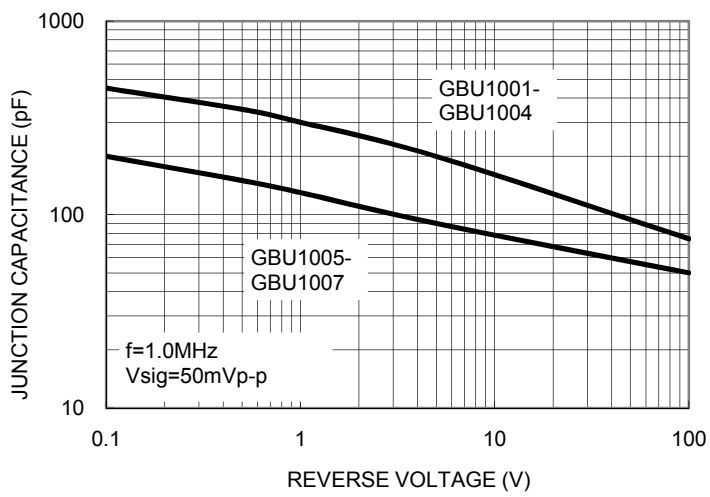
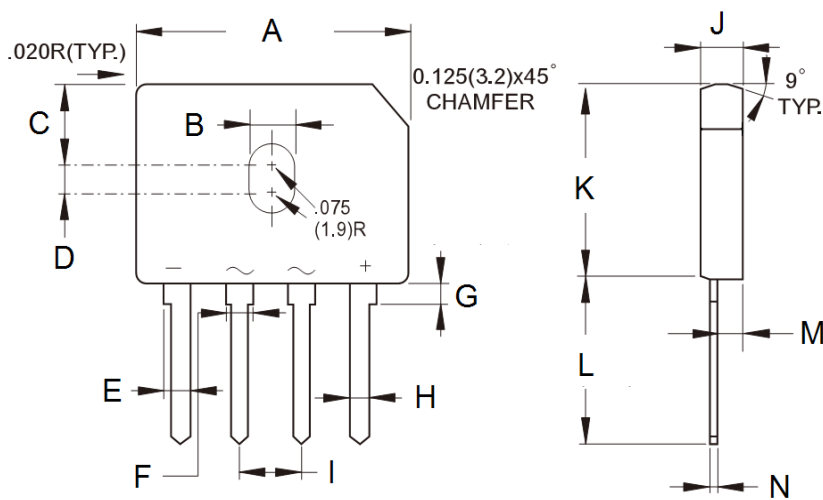

FIG. 5 TYPICAL JUNCTION CAPACITANCE PER LEG



PACKAGE OUTLINE DIMENSIONS

GBU



| DIM. | Unit (mm) | | Unit (inch) | |
|------|-----------|-------|-------------|-------|
| | Min | Max | Min | Max |
| A | 21.80 | 22.30 | 0.858 | 0.878 |
| B | 3.50 | 4.10 | 0.138 | 0.161 |
| C | 7.40 | 7.90 | 0.291 | 0.311 |
| D | 1.65 | 2.16 | 0.065 | 0.085 |
| E | 2.16 | 2.54 | 0.085 | 0.100 |
| F | 1.65 | 2.03 | 0.065 | 0.080 |
| G | 1.52 | 2.03 | 0.060 | 0.080 |
| H | 1.02 | 1.27 | 0.040 | 0.050 |
| I | 4.83 | 5.33 | 0.190 | 0.210 |
| J | 3.30 | 3.56 | 0.130 | 0.140 |
| K | 18.30 | 18.80 | 0.720 | 0.740 |
| L | 17.50 | 18.00 | 0.689 | 0.709 |
| M | 1.90 | 2.16 | 0.075 | 0.085 |
| N | 0.46 | 0.56 | 0.018 | 0.022 |

MARKING DIAGRAM



- P/N = Specific Device Code
- G = Green Compound
- YW = Date Code
- F = Factory Code

Notice

Specifications of the products displayed herein are subject to change without notice. TSC or anyone on its behalf, assumes no responsibility or liability for any errors or inaccuracies.

Information contained herein is intended to provide a product description only. No license, express or implied, to any intellectual property rights is granted by this document. Except as provided in TSC's terms and conditions of sale for such products, TSC assumes no liability whatsoever, and disclaims any express or implied warranty, relating to sale and/or use of TSC products including liability or warranties relating to fitness for a particular purpose, merchantability, or infringement of any patent, copyright, or other intellectual property right.

The products shown herein are not designed for use in medical, life-saving, or life-sustaining applications. Customers using or selling these products for use in such applications do so at their own risk and agree to fully indemnify TSC for any damages resulting from such improper use or sale.

X-ON Electronics

Largest Supplier of Electrical and Electronic Components

Click to view similar products for [Bridge Rectifiers](#) category:

Click to view products by [Taiwan Semiconductor](#) manufacturer:

Other Similar products are found below :

[G3SBA60-E351](#) [GBJ1504-BP](#) [GBU10B-BP](#) [GBU15J-BP](#) [GBU15K-BP](#) [GBU4A-BP](#) [GBU4D-BP](#) [GBU6B-E3/45](#) [GSIB680-E3/45](#) [DB101-BP](#) [DF10SA-E345](#) [RMB2S](#) [RCG](#) [APT30DF100HJ](#) [APT60DF20HJ](#) [B2S-E3/80](#) [BU1506-E351](#) [BU15085S-E345](#) [BU1508-E3/45](#) [BU1510-E3/45](#) [RS404GL-BP](#) [RS405GL-BP](#) [G3SBA20-E3/51](#) [G5SBA20-E3/51](#) [G5SBA60-E3/51](#) [GBJ1502-BP](#) [GBL02-E351](#) [GBL10-E3/45](#) [GBU10J-BP](#) [GBU4J-BP](#) [GBU4K-BP](#) [GBU8B-E3/45](#) [GBU8D-BP](#) [GBU8J-BP](#) [GSIB1520-E3/45](#) [MB1510](#) [MB352W](#) [MB6M-G](#) [B2M-E345](#) [B40C7000A](#) [B500C7000A](#) [MP5010W-BP](#) [MP501W-BP](#) [MP502-BP](#) [BR1005-BP](#) [BR101-BP](#) [BU1006-E345](#) [BU12065S-E3/45](#) [BU1508-E3/51](#) [BU2006-E3/45](#) [BU2008-E345](#)