

AA

# ALKALINE POWER

## Specifications

<b>Classification:</b>	Alkaline
<b>Chemical System:</b>	Zinc-Manganese Dioxide (Zn/MnO <sub>2</sub> ) No added mercury or cadmium
<b>Designation:</b>	ANSI-15A, IEC-LR6
<b>Nominal Voltage:</b>	1.5 volts
<b>Nominal IR:</b>	150 to 300 milliohms (fresh)
<b>Operating Temp:</b>	-18°C to 55°C (0°F to 130°F)
<b>Typical Weight:</b>	22.7 grams (0.8 oz.)
<b>Typical Volume:</b>	8.1 cubic centimeters (0.5 cubic inch)
<b>Jacket:</b>	Plastic Label
<b>Terminal:</b>	Flat Contact

## Industry Standard Dimensions

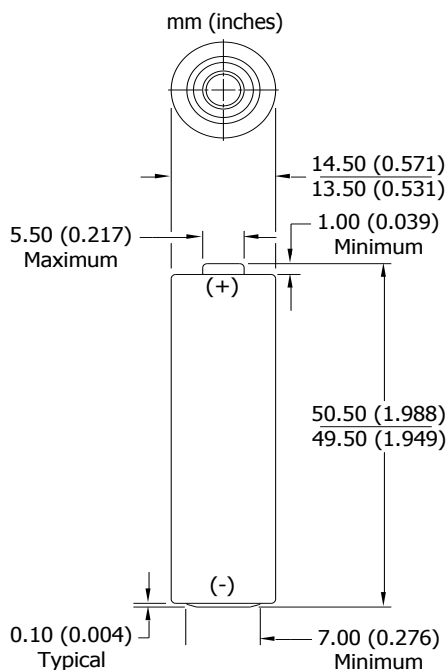

## Milliamp-Hours Capacity

Continuous discharge to 0.8 volts at 21°C

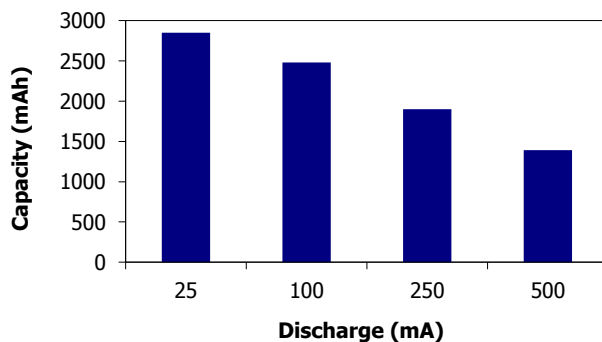

## Constant Current Performance

Typical Characteristics (21°C)

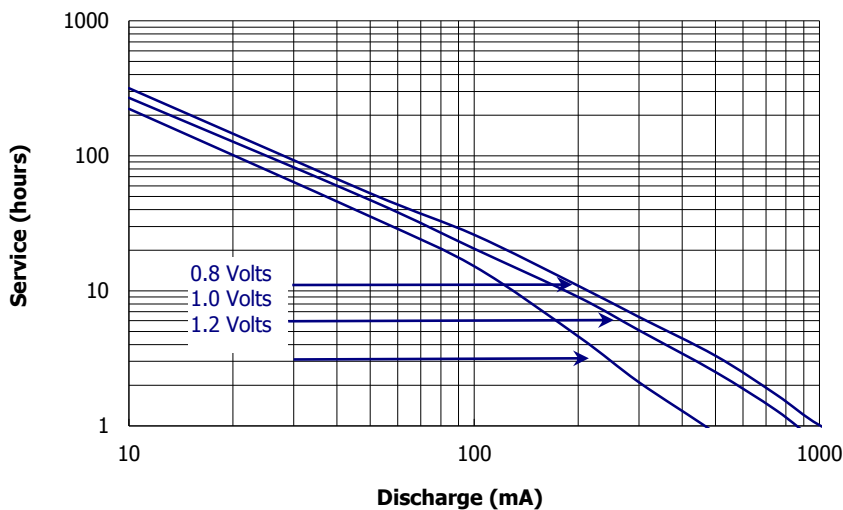

# ENERGIZER ALKALINE POWER

**AA**

## Industry Standard Tests (21°C)

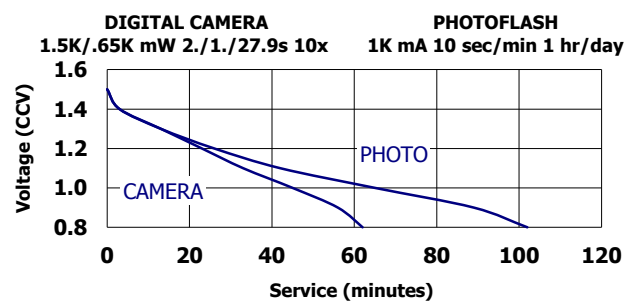
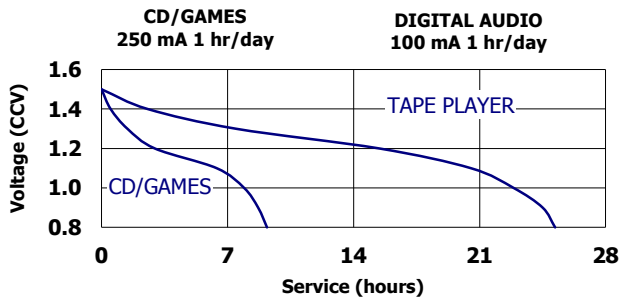
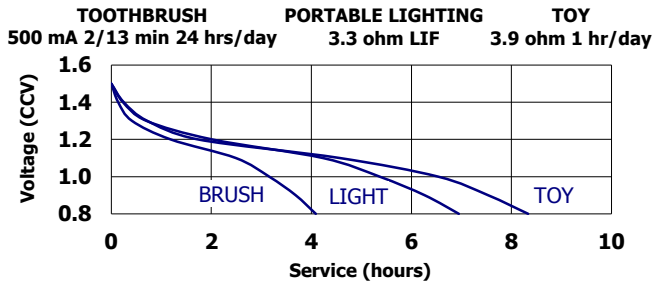
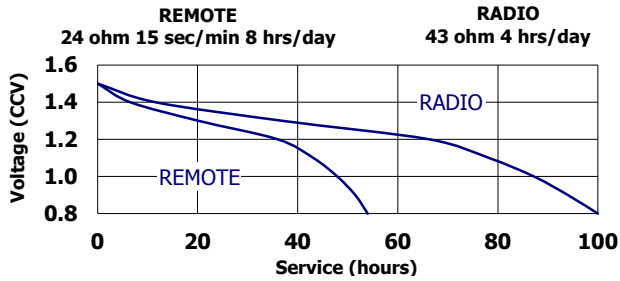

Pack Quantity : 24  
 Manufacturers Part Number : E300173100

## X-ON Electronics

Largest Supplier of Electrical and Electronic Components

*Click to view similar products for [energizer manufacturer](#):*

Other Similar products are found below :

[1215F2X3](#) [E11A B2](#) [LR43 186](#) [AC13](#) [AC675](#) [3LR12](#) [603298](#) [625302](#) [625304](#) [638006](#) [639830](#) [S9025](#) [7638900426687](#) [7638900414660](#)  
[E92 MAX](#) [E91 MAX](#) [HARD CASE RECHARGEABLE](#) [HARD CASE PRO MULTI USE](#) [HCHD311](#) [S9029](#) [639826](#) [603386](#) [HARD CASE](#)  
[PROFF 4AA](#) [HARDCASE PRO HEADLIGHT](#) [639618](#) [RCLINM2WR](#) [S8865](#) [S8707](#) [S8100](#) [7638900424478](#) [7638900313130](#) [626177](#)  
[E300116200](#) [639838](#) [HARDCASE PRO WORK LIGHT](#) [603305](#) [E300280600](#) [METAL LED 6AA](#) [S8864](#) [HDD32E](#) [MS2AALED](#)  
[ENERGIZERÂ® 2-IN-1 LANTERN HANDHELD](#) [E300124200](#) [E300171700](#) [ENFFL81E](#) [E300112600](#) [633474](#) [HDA32E](#) [7638900421422](#)  
[HARD CASE PRO PIVOT](#)