

# SKT 24



## Stud Thyristor

## Line Thyristor

### SKT 24

### Features

- Hermetic metal case with glass insulator
- Threaded stud ISO M6 or UNF 1/4-28
- International standard case

### Typical Applications

- DC motor control (e. g. for machine tools)
- Controlled rectifiers (e. g. for battery charging)
- AC controllers (e. g. for temperature control)
- Recommended snubber network e. g. for  $V_{VRMS} \leq 400$  V:  
 $R = 100 \Omega/5$  W,  $C = 0,1 \mu F$

1) Available with UNF thread 1/4-28 UNF2A, e. g. SKT 24/12E UNF

$V_{RSM}$ V	$V_{RRM}, V_{DRM}$ V	$I_{TRMS} = 50$ A (maximum value for continuous operation) $I_{TAV} = 24$ A (sin. 180; $T_c = 95$ °C)	
500	400	SKT 24/04D	
900	800	SKT 24/08D	
1300	1200	SKT 24/12E <sup>1)</sup>	
1500	1400	SKT 24/14E	
1700	1600	SKT 24/16E <sup>1)</sup>	
1900	1800	SKT 24/18E	

Symbol	Conditions	Values	Units
$I_{TAV}$	sin. 180; $T_c = 100$ (85) °C;	22 (29)	A
$I_D$	K5; $T_a = 45$ °C; B2 / B6 K3; $T_a = 45$ °C; B2 / B6	22 / 30 28 / 40	A A
$I_{RMS}$	K5; $T_a = 45$ °C; W1C	24	A
$I_{TSM}$	$T_{vj} = 25$ °C; 10 ms $T_{vj} = 130$ °C; 10 ms	450 380	A A
$i^2t$	$T_{vj} = 25$ °C; 8,35 ... 10 ms $T_{vj} = 130$ °C; 8,35 ... 10 ms	1000 720	A <sup>2</sup> s A <sup>2</sup> s
$V_T$	$T_{vj} = 25$ °C; $I_T = 75$ A	max. 1,9	V
$V_{T(TO)}$	$T_{vj} = 130$ °C	max. 1	V
$r_T$	$T_{vj} = 130$ °C	max. 10	mΩ
$I_{DD}, I_{RD}$	$T_{vj} = 130$ °C; $V_{RD} = V_{RRM}, V_{DD} = V_{DRM}$	max. 8	mA
$t_{gd}$	$T_{vj} = 25$ °C; $I_G = 1$ A; $di_G/dt = 1$ A/μs	1	μs
$t_{gr}$	$V_D = 0,67 * V_{DRM}$	2	μs
$(di/dt)_{cr}$	$T_{vj} = 130$ °C	max. 50	A/μs
$(dv/dt)_{cr}$	$T_{vj} = 130$ °C; SKT ...D / SKT ...E	max. 500 / 1000	V/μs
$t_q$	$T_{vj} = 130$ °C	80	μs
$I_H$	$T_{vj} = 25$ °C; typ. / max.	80 / 150	mA
$I_L$	$T_{vj} = 25$ °C; typ. / max.	150 / 300	mA
$V_{GT}$	$T_{vj} = 25$ °C; d.c.	min. 3	V
$I_{GT}$	$T_{vj} = 25$ °C; d.c.	min. 100	mA
$V_{GD}$	$T_{vj} = 130$ °C; d.c.	max. 0,25	V
$I_{GD}$	$T_{vj} = 130$ °C; d.c.	max. 3	mA
$R_{th(j-c)}$	cont.	0,8	K/W
$R_{th(j-c)}$	sin. 180	0,9	K/W
$R_{th(j-c)}$	rec. 120	0,95	K/W
$R_{th(c-s)}$		0,5	K/W
$T_{vj}$		- 40 ... + 130	°C
$T_{stg}$		- 40 ... + 150	°C
$V_{isol}$		-	V~
$M_s$	to heatsink	2,5	Nm
$a$		5 * 9,81	m/s <sup>2</sup>
$m$	approx.	13	g
Case		B 2	



SKT

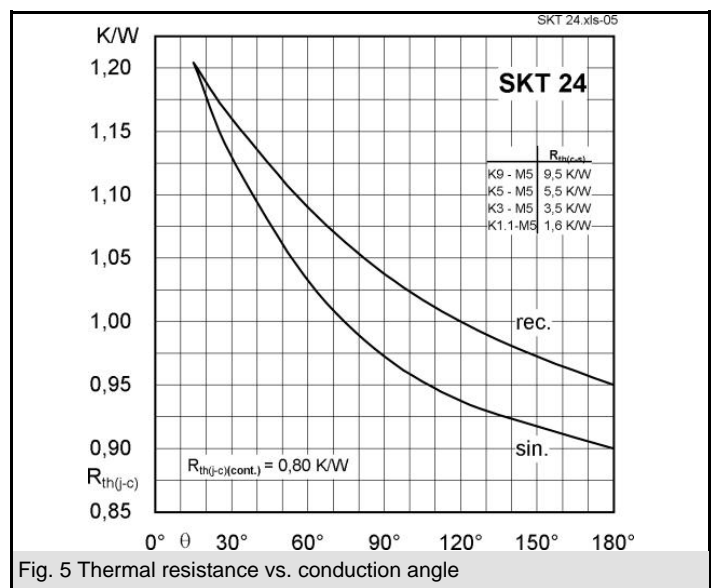
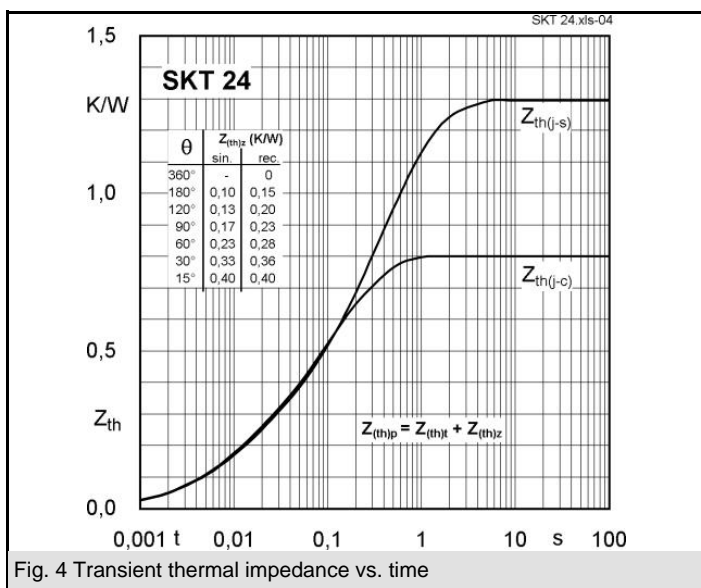
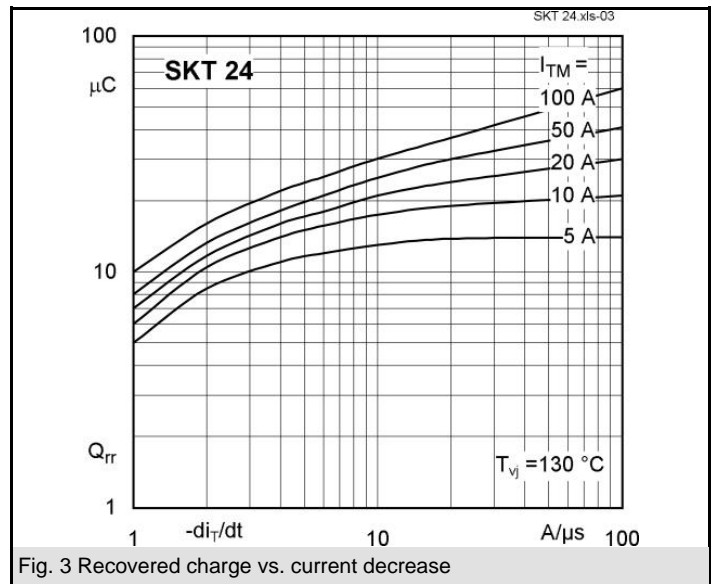
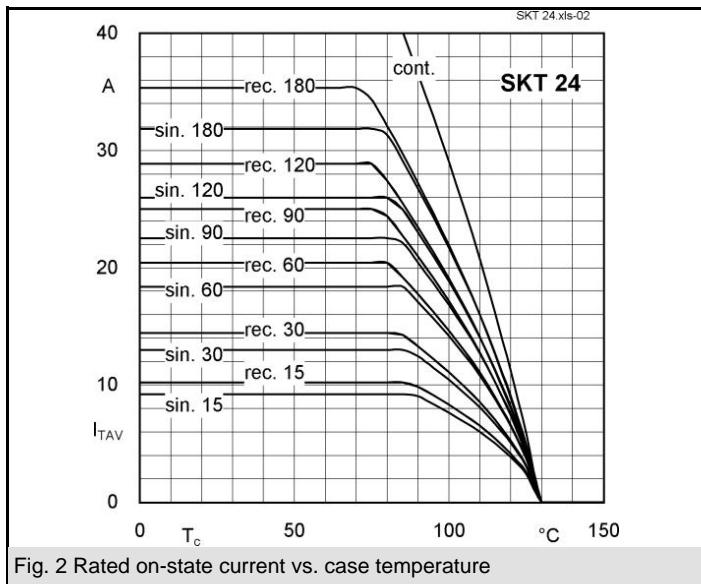
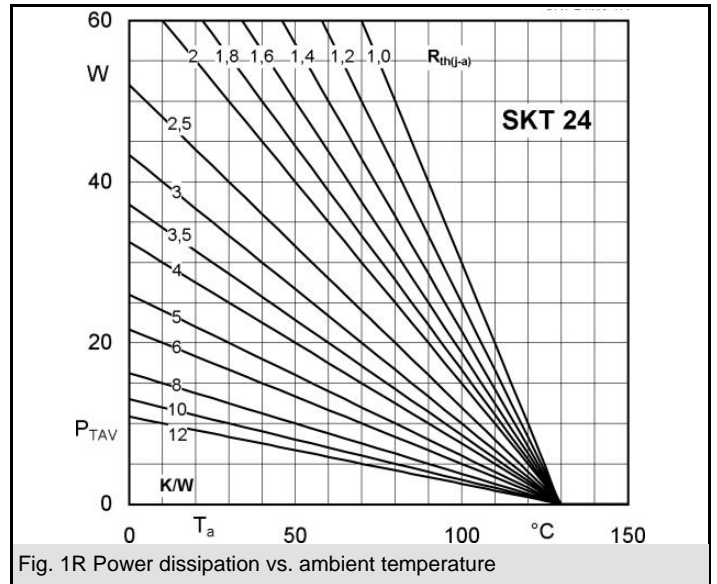
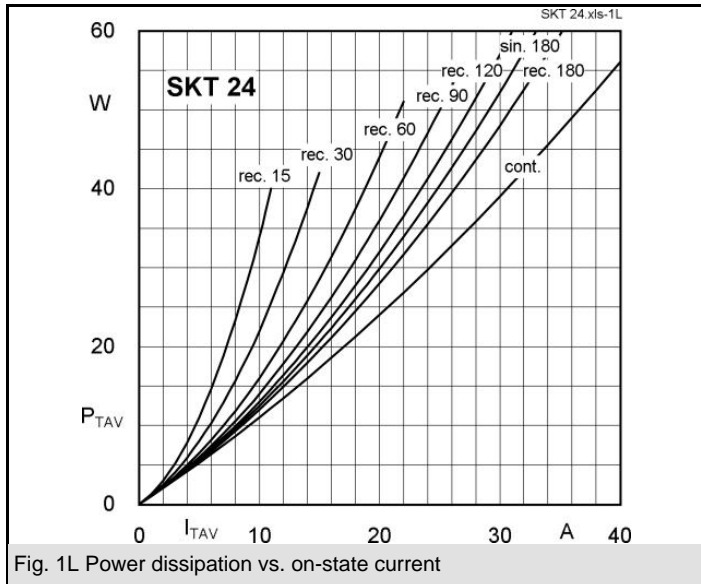

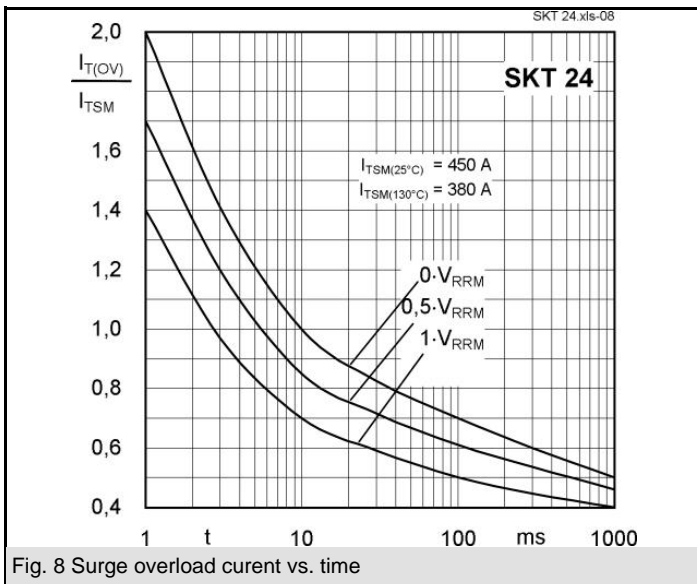
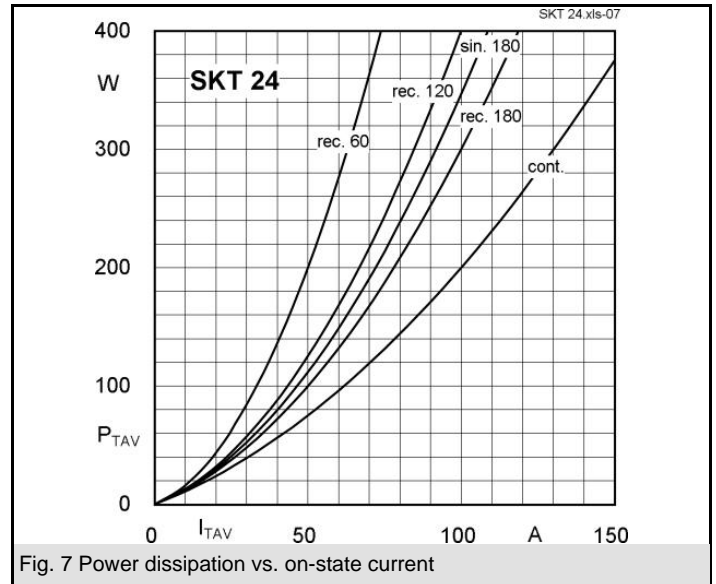
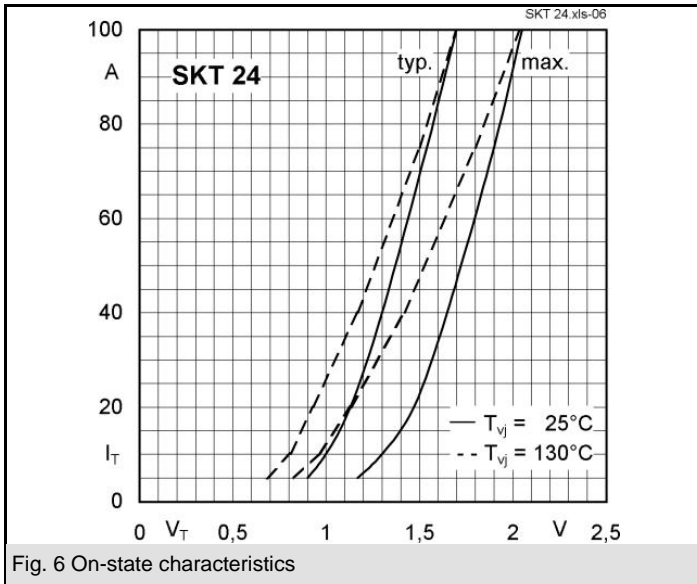

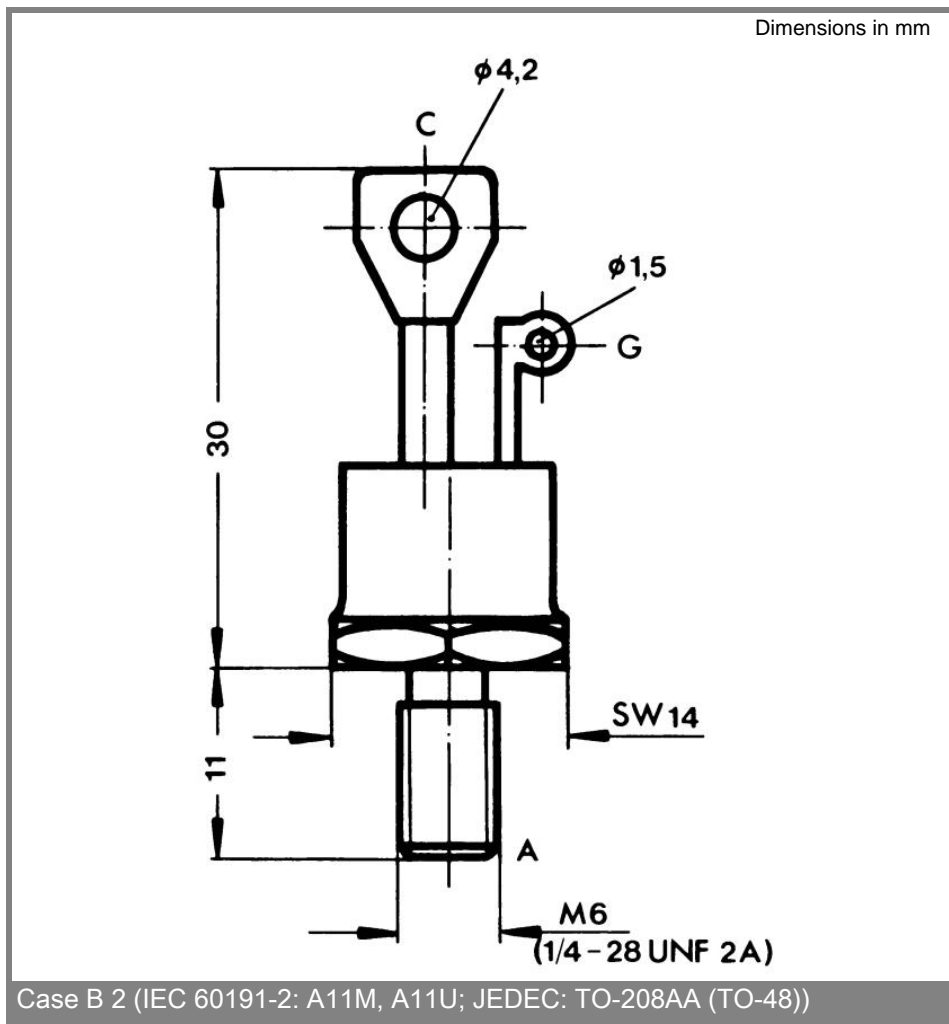
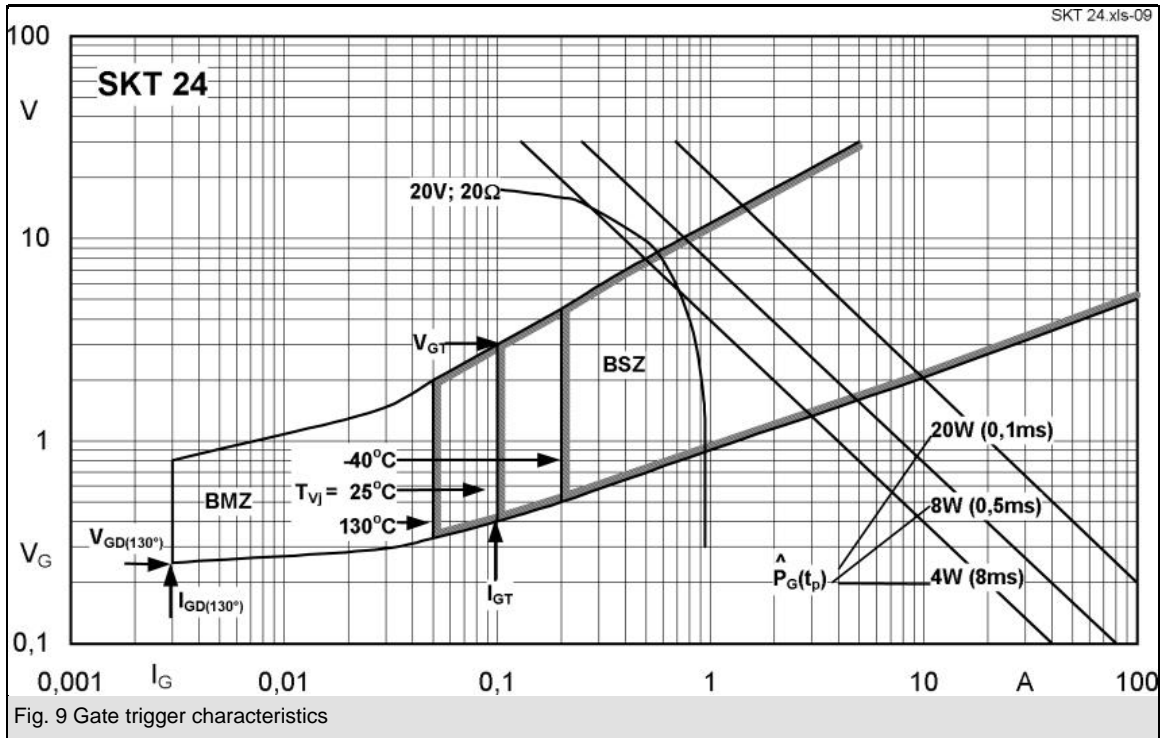

This technical information specifies semiconductor devices but promises no characteristics. No warranty or guarantee expressed or implied is made regarding delivery, performance or suitability.

# X-ON Electronics

Authorized Distributor

*Click to view similar products for [SCRs category](#).*

*Click to view products by [Semikron manufacturer](#).*

Other Similar products are found below :

[SKT4016E](#) [TYN616](#) [T321608](#) [T321610](#) [CS2316IO2](#) [CS2208io1M](#) [SK055M](#) [SK040NRP](#)  
[SK025R](#) [SK016NRP](#) [2N6508TG](#) [2N6507TG](#) [2N6507](#) [2N6405G](#) [2N6399G](#) [2N2329](#)  
[S8070WTP](#) [S8070W](#) [S8055W](#) [S8055NRP](#) [S8035KTP](#) [S8025RTP](#) [S8025NRP](#) [S6X8ES1](#)  
[S6055W](#)