

Features

Electronic voltage monitoring relays for single and three-phase applications

- Multifunctional types, providing the flexibility of monitoring Undervoltage, Overvoltage, Window Mode, Phase rotation, Phase loss, Asymmetry and Neutral loss
- Positive safety logic - Make output contact opens if the relay detects an error
- All functions and values can be easily adjusted by the selector and trimmer on front face
- "Blade + cross" – both flat blade and cross head screw drivers can be used to adjust the regulators and the function selector
- Colored LEDs for clear & immediate visual indication
- 1 CO relay output, 6 or 10 A
- Modular housing, 17.5 or 35 mm wide
- 35 mm rail (EN 60715) mount
- Cd-free contact material

Screw terminal



For outline drawing see page 8

Contact specification

Contact configuration	1 CO (SPDT)	1 CO (SPDT)	1 CO (SPDT)
Rated current/Maximum peak current A	10 / 30	6 / 10	6 / 10
Rated voltage/Max. switching voltage V AC	250 / 400	250 / 400	250 / 400
Rated load AC1 VA	2,500	1,500	1,500
Rated load AC15 VA	750	500	500
Single phase motor rating (230 V AC) kW	0.5	0.185	0.185
Breaking capacity DC1: 30/110/220 V A	10 / 0.3 / 0.12	6 / 0.2 / 0.12	6 / 0.2 / 0.12
Minimum switching load mW (V/mA)	300 (5 / 5)	500 (12 / 10)	500 (12 / 10)
Standard contact material	AgNi	AgNi	AgNi

Supply specification

Nominal system voltage (U_N) V AC (50/60 Hz)	220...240	380...415	380...415
Rated power VA (50 Hz) / W	2.6 / 0.8	11 / 0.9	11 / 0.9
Operating range V AC (50/60 Hz)	130...280	220...510	220...510

Technical data

Electrical life at rated load AC1 cycles	$80 \cdot 10^3$	$60 \cdot 10^3$	$60 \cdot 10^3$
Voltage detection level range V	170...270	300...480	300...480
Asymmetry detection level range %	—	—	4...25
Switch-off delay time (T on function diagrams) s	0.5...60	0.5...60	0.5...60
Switch-on lock-out time s	0.5	1	1
Switch-on hysteresis (H on function diagrams) V	5 (L-N)	10 (L-L)	10 (L-L)
Power-on activation time s	≈ 1	≈ 1	≈ 1
Insulation between supply and contacts (1.2/50 μ s) kV	4	4	4
Dielectric strength between open contacts V AC	1,000	1,000	1,000
Ambient temperature $^{\circ}$ C	-20...+50	-20...+50	-20...+50
Protection category	IP20	IP20	IP20

Approvals (according to type)



Features

Electronic phase loss and rotation monitoring relay for three-phase applications

- Universal voltage monitoring (U_N from 208 V to 480 V, 50/60 Hz)
- Phase loss monitoring, even under phase regeneration
- Positive safety logic - Make contact opens if the relay detects an error
- 1 CO relay output, 6 A
- Compact size (17.5 mm wide)
- 35 mm rail (EN 60715) mount
- European patent pending for the innovative principle at the root of the 3 phase monitoring and error survey system

NEW 70.61



Three-phase (208...480 V) voltage monitoring:

- Phase loss
- Phase rotation

Screw terminal



For outline drawing see page 8

Contact specification

Contact configuration		1 CO (SPDT)
Rated current/Maximum peak current	A	6 / 15
Rated voltage/Max. switching voltage	V AC	250 / 400
Rated load AC1	VA	1,500
Rated load AC15	VA	250
Single phase motor rating (230 V AC)	kW	0.185
Breaking capacity DC1: 30/110/220 V	A	3 / 0.35 / 0.2
Minimum switching load	mW (V/mA)	500 (10 / 5)
Standard contact material		AgCdO

Supply specification

Nominal system voltage (U_N)	V AC (50/60 Hz)	208...480
Rated power	VA (50 Hz) / W	8/1
Operating range	V AC (50/60 Hz)	170...500

Technical data

Electrical life at rated load AC1	cycles	$100 \cdot 10^3$
Switch-off delay time	s	0.5
Switch-on lock-out time	s	0.5
Power-on activation time	s	< 2
Insulation between supply and contacts (1.2/50 μ s)	kV	5
Dielectric strength between open contacts	V AC	1,000
Ambient temperature	$^{\circ}$ C	-20...+50
Protection category		IP20

Approvals (according to type)



Ordering information

Example: 70 series, three-phase voltage monitoring relay, 1 output, supply voltage 380...415 V AC.



- Series** _____
- Type** _____
 1 = 1 phase AC line monitoring
 3 = 3 phase AC line monitoring
 4 = 3 phase + neutral AC line monitoring
 6 = 3 phase loss and rotation monitoring
- No. of poles** _____
 1 = 1 pole
- Supply version** _____
 8 = AC (50/60 Hz)
- Supply voltage** _____
 230 = 220...240 V (70.11)
 400 = 380...415 V (70.31/41)
 400 = 208...480 V (70.61)

- D: Fault memory option**
 0 = No fault memory
 2 = Fault memory function selectable
- C: Time delay setting**
 0 = Fixed switch-off delay
 2 = Adjustable switch-off delay
 3 = Adjustable switch-off delay and asymmetry
- B: Contact circuit**
 0 = CO
- A: Detection values**
 0 = Non-adjustable detection values
 2 = 2 adjustable detection values
- Codes**
 70.11.8.230.2022
 70.31.8.400.2022
 70.41.8.400.2030
 70.61.8.400.0000

Monitoring and function overview

	70.11	70.31	70.41	70.61
Supply system type	Single phase system	3-phase systems	3-phase systems	3-phase systems
Nominal voltage 50/60 Hz	V 220...240	380...415	380...415	208...480
Undervoltage with/without memory (selectable)	•	•	—	—
Overvoltage with/without memory (selectable)	•	•	—	—
Window Mode with/without memory (selectable)	•	•	—	—
Window Mode without memory	—	—	•	—
Phase loss	—	•	•	•
Phase rotation	—	•	•	•
Phase asymmetry	—	—	•	—
Neutral loss selectable	—	—	•	—

Technical data

Insulation		70.11/31/41		70.61
Between supply and contacts	dielectric strength	V AC	2,500	3,000
	impulse (1.2/50 µs)	kV	4	5
Between open contacts	dielectric strength	V AC	1,000	1,000
	impulse (1.2/50 µs)	kV	1.5	1.5
EMC specifications				
Type of test		Reference standard		
Electrostatic discharge	contact discharge	EN 61000-4-2		4 kV
	air discharge	EN 61000-4-2		8 kV
Radiated electromagnetic field	80 ... 1,000 MHz	EN 61000-4-3		10 V/m
	1 ... 2.8 GHz	EN 61000-4-3		5 V/m
Fast transients (burst 5/50 ns, 5 and 100 kHz)	on supply terminals	EN 61000-4-4		4 kV
Voltage pulses on supply terminals (surge 1.2/50 µs)	common mode	EN 61000-4-5		4 kV
	differential mode	EN 61000-4-5		4 kV
Radiofrequency common mode voltage (0.15...230 MHz)	on supply terminals	EN 61000-4-6		10 V
Voltage dips	70 % U _N	EN 61000-4-11		25 cycles
Short interruptions		EN 61000-4-11		1 cycle
Radiofrequency conducted emissions	0.15...30 MHz	CISPR 11		class B
Radiated emissions	30...1,000 MHz	CISPR 11		class B
Terminals		solid cable		stranded cable
Max. wire size	mm ²	1 x 6 / 2 x 4		1 x 4 / 2 x 2.5
	AWG	1 x 10 / 2 x 12		1 x 12 / 2 x 14
⊕ Screw torque	Nm	0.8		
Wire strip length	mm	9		
Other data		70.11	70.31/41	70.61
Power lost to the environment	without output current	W	0.8	1
	with rated output current	W	2	1.4

Functions

Output relay On (NO closed) when all OK: positive logic.

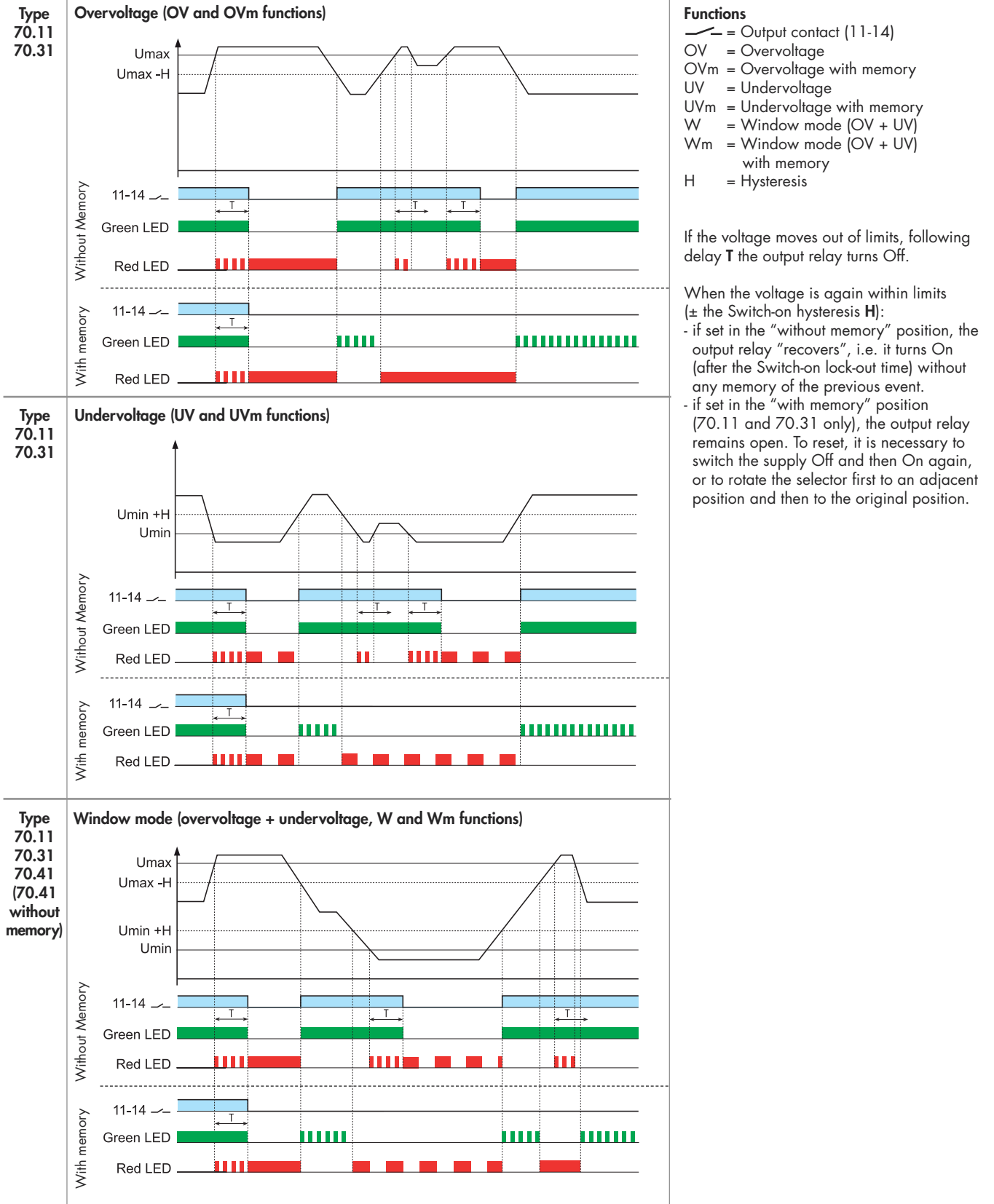

Functions

Output relay On (NO closed) when all OK: positive logic.

<p>Type 70.31 70.41 70.61</p>	<p>Phase loss and phase rotation</p>	<p>If the sequence (L1, L2, L3) is incorrect at power-on, the output relay will not turn-on.</p> <p>If a phase is lost, the output relay turns off immediately. When the phase is again active, the output relay turns on immediately.</p> <p>For type 70.61: Phase loss monitoring possible even under regeneration up to 80% of the average of the other 2 phases.</p>
<p>Type 70.41</p>	<p>Neutral loss and asymmetry</p>	<p>If the neutral is lost (and the Neutral control function is set), the output relay turns off immediately. When the neutral is again present, the output relay turns on immediately.</p> <p>If the asymmetry $(U_{max} - U_{min})/U_N$ is above the % set value, the output relay turns off after the set delay T. When the asymmetry is again below the % set value (with a fixed hysteresis of approximately 2%), the output relay turns on after the Switch-on lock-out time.</p>

Front view: function selector and regulators

<p>70.11</p> <p>Functions: OV, OVm, UV, UVm, W, Wm</p> <p>T_{off} delay: (0.5...60) sec</p> <p>U_{Max}: (220...270) V</p> <p>U_{Min}: (170...230) V</p>	<p>70.31</p> <p>Functions: OV, OVm, UV, UVm, W, Wm</p> <p>U_{Max}: (380...480) V</p> <p>U_{Min}: (300...400) V</p> <p>T_{off} delay: (0.5...60) sec</p>	<p>70.41</p> <p>N = With N-line monitoring N = Without N-line monitoring</p> <p>U_{Max}: (380...480) V</p> <p>(4...25) % U_N</p> <p>U_{Min}: (300...400) V</p> <p>T_{off} delay: (0.5...60) sec</p>
---	---	--

LED indication

Monitoring relay Type	LED	Supply system normal	Supply system abnormal (Voltage out of limits, switch-off delay time T running)	Supply system abnormal (Reason for switch-off, RESET necessary when "with Memory"* is selected)
		Contact 11 - 14 closed	Contact 11 - 14 closed	Contact 11-14 open
70.11.8.230.2022	<ul style="list-style-type: none"> • • 			<ul style="list-style-type: none"> Overvoltage OV and OVm Undervoltage UV and UVm With Memory, following a failure a manual "RESET" ** is necessary
70.31.8.400.2022	<ul style="list-style-type: none"> • • • 			<ul style="list-style-type: none"> Overvoltage OV and OVm Undervoltage UV and UVm Phase loss Phase rotation With Memory, following a failure a manual "RESET" ** is necessary
70.41.8.400.2030	<ul style="list-style-type: none"> • • • 			<ul style="list-style-type: none"> Overvoltage OV Undervoltage UV Asymmetry Phase loss Neutral loss Phase rotation
70.61.8.400.0000	<ul style="list-style-type: none"> • 			<ul style="list-style-type: none"> Phase rotation or Phase loss

* The function "with Memory" is only available for type 70.11 and 70.31.

** It is necessary to switch the supply OFF and then On again (U off U on) or to rotate the function selector first to an adjacent position and then to the original position.

Wiring diagrams

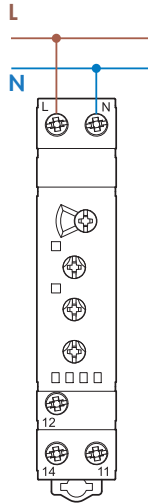

Type 70.11

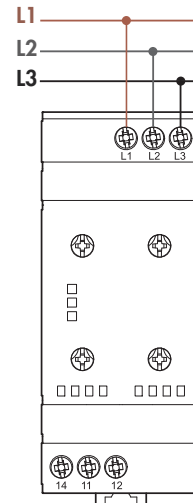

Type 70.31

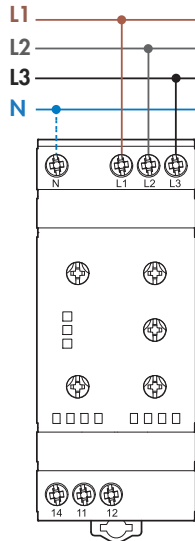

Type 70.41

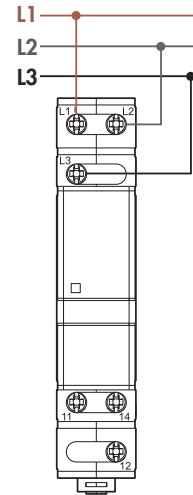

Type 70.61

Application example

The output contact switches the coil of the line contactor.

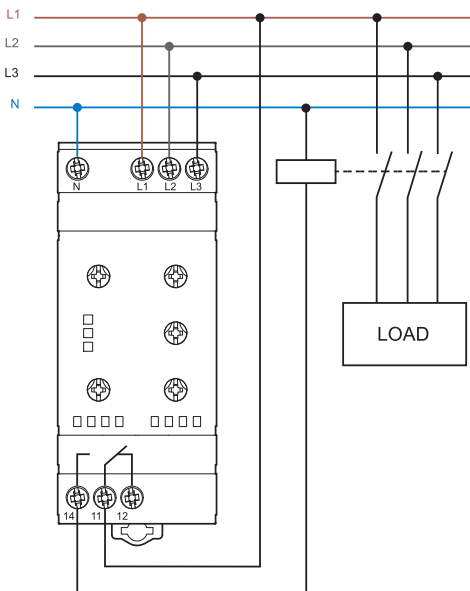

Outline drawings

70.11
Screw terminal

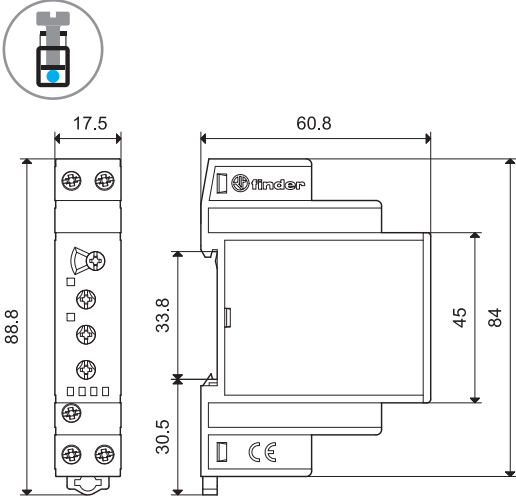

70.31
Screw terminal

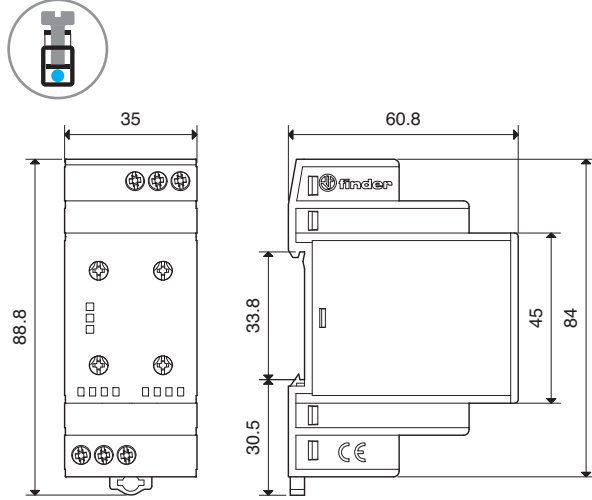

70.41
Screw terminal

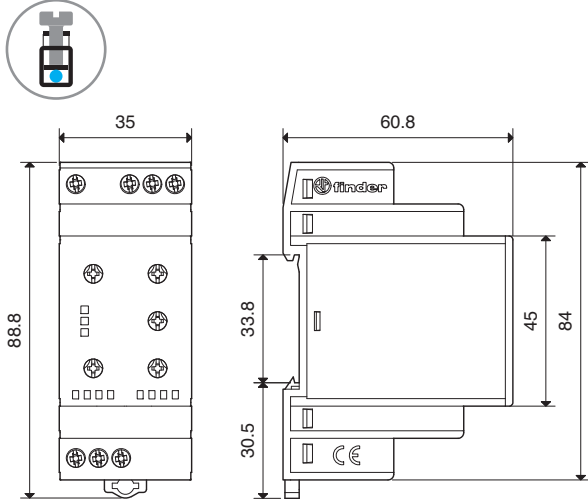

70.61
Screw terminal

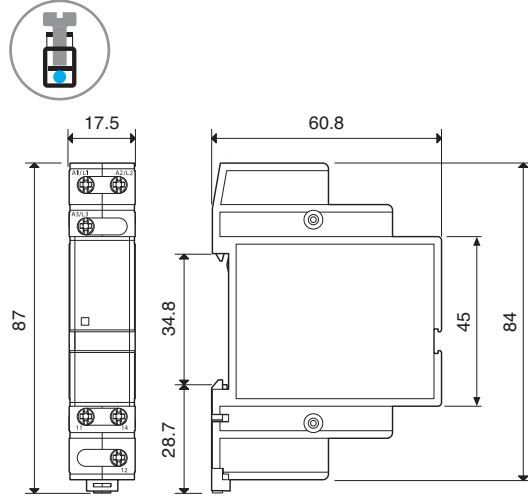

Accessories



020.01

Adaptor for panel mounting, plastic, 17.5 mm wide for 70.11 and 70.61

020.01

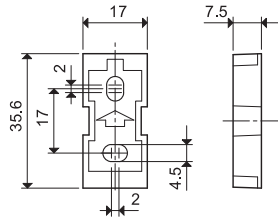

011.01

Adaptor for panel mounting, plastic, 35 mm wide for 70.31 and 70.41

011.01

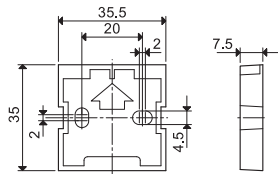

060.72

Sheet of marker tags, plastic, 72 tags, 6x12 mm for 70.11, 70.31 and 70.41

060.72



020.24

Sheet of marker tags, plastic, 24 tags, 9x17 mm for 70.61

020.24



019.01

Identification tag, plastic, 1 tag, 17x25.5 mm for 70.11, 70.31 and 70.41

019.01



020.03

Separator for rail mounting, plastic, 3 mm wide

020.03

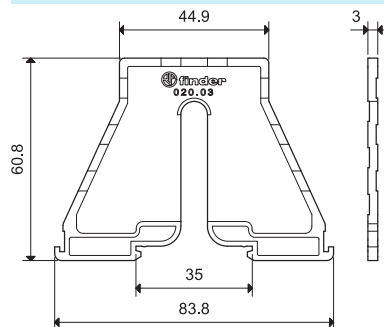

X-ON Electronics

Largest Supplier of Electrical and Electronic Components

Click to view similar products for [finder manufacturer](#):

Other Similar products are found below :

[66.82.8.230.0000](#) [14.81.8.230.0000](#) [14.71.8.230.0000](#) [20.23.8.012.4000](#) [22.22.9.012.4000](#) [22.34.0.024.4340](#) [22.34.0.024.4720](#)
[22.64.0.230.4310](#) [20.21.8.024.4000](#) [20.22.8.024.4000](#) [20.28.8.024.4000](#) [22.22.8.024.4000](#) [22.32.0.230.4440](#) [26.06.8.024.0000](#)
[40.52.8.006.0000](#) [44.52.9.060.0000](#) [10.42.8.230.0000](#) [11.42.8.230.0000](#) [88.02.0.230.0002](#) [96.04SMA](#) [55.12.8.024.0000](#) [55.33.8.230.0000](#)
[56.34.9.024.0000T](#) [66.82.8.230.0300](#) [39.11.0.006.0060](#) [55.14.8.024.0000](#) [40.31.8.240.0000](#) [66.22.8.230.1300](#) [72.11.8.024.0000](#)
[71.51.8.230.1021](#) [4CP281100060SPA](#) [18.21.8.230.0300](#) [40.62.9.024.0000](#) [50.14.9.024.4310](#) [7S.16.9.012.0420](#) [83.91.0.240.0000](#)
[12.11.8.230.1000](#) [22.22.9.048.4000](#) [22.64.0.230.4710](#) [26.08.8.012.0000](#) [20.21.8.012.4000](#) [20.23.9.110.4000](#) [20.26.8.230.4000](#)
[22.34.0.230.4340](#) [22.34.0.230.4620](#) [22.34.0.230.4720](#) [22.44.0.230.4710](#) [10.61.8.230.0000](#) [55.14.9.012.0000](#) [22.32.0.012.4420](#)