

Base strip - MSTBA 2,5/ 7-G-5,08 - 1757297

Please be informed that the data shown in this PDF Document is generated from our Online Catalog. Please find the complete data in the user's documentation. Our General Terms of Use for Downloads are valid (<http://phoenixcontact.com/download>)

Header, Nominal current: 12 A, Rated voltage (III/2): 320 V, Number of positions: 7, Pitch: 5.08 mm, Color: green, Contact surface: Tin, Mounting: Wave soldering



The figure shows a 10-position version of the product

Why buy this product

- Other pin lengths available on request
- Plug-in direction parallel to the conductor axis
- W type with stand-off
- Standard pin strip for 320 V (III/2)



Key Commercial Data

| | |
|--------------------------------------|---------------|
| Packing unit | 100 STK |
| GTIN | |
| GTIN | 4017918029821 |
| Weight per Piece (excluding packing) | 2.780 g |
| Custom tariff number | 85366990 |
| Country of origin | Germany |

Technical data

Environmental Product Compliance

| | |
|------------|--|
| China RoHS | No hazardous substances above threshold values |
|------------|--|

Dimensions

| | |
|-----------------------|----------|
| Length | 12 mm |
| Pitch | 5.08 mm |
| Dimension a | 30.48 mm |
| Width | 37.48 mm |
| Constructional height | 8.6 mm |
| Height | 12.1 mm |

Base strip - MSTBA 2,5/ 7-G-5,08 - 1757297

Technical data

Dimensions

| | |
|--------------------------|----------|
| Length of the solder pin | 3.5 mm |
| Pin dimensions | 1 x 1 mm |
| Hole diameter | 1.4 mm |

General

| | |
|--|----------------|
| Range of articles | MSTBA 2,5/..-G |
| Insulating material group | I |
| Rated surge voltage (III/3) | 4 kV |
| Rated surge voltage (III/2) | 4 kV |
| Rated surge voltage (II/2) | 4 kV |
| Rated voltage (III/3) | 250 V |
| Rated voltage (III/2) | 320 V |
| Rated voltage (II/2) | 400 V |
| Connection in acc. with standard | EN-VDE |
| Nominal current I_N | 12 A |
| Maximum load current | 12 A |
| Insulating material | PA |
| Flammability rating according to UL 94 | V0 |
| Color | green |
| Number of positions | 7 |

Standards and Regulations

| | |
|--|--------|
| Connection in acc. with standard | EN-VDE |
| | CSA |
| Flammability rating according to UL 94 | V0 |

Drawings

Drilling diagram

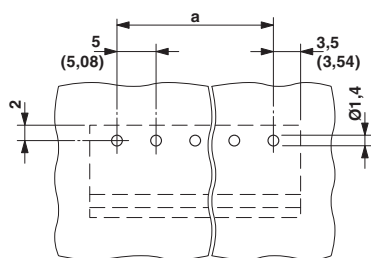

Diagram

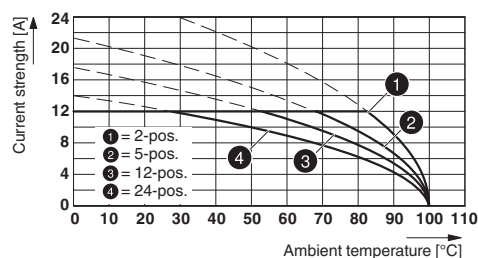

Type: ICV 2,5/..-G-5,08 with MSTBA 2,5/..-G-5,08

Base strip - MSTBA 2,5/ 7-G-5,08 - 1757297

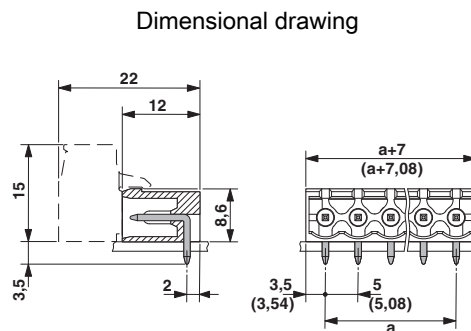
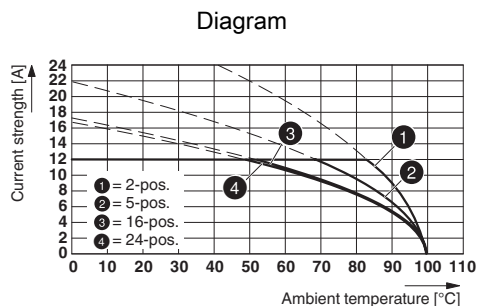

Type: IC 2,5/...-G-5,08 with MSTBA 2,5/...-G-5,08

Diagram

Diagram

Diagram

Diagram

Diagram

Classifications

eCl@ss

| | |
|------------|----------|
| eCl@ss 4.0 | 272607xx |
| eCl@ss 4.1 | 27260701 |
| eCl@ss 5.0 | 27260701 |
| eCl@ss 5.1 | 27260701 |
| eCl@ss 6.0 | 27260704 |
| eCl@ss 7.0 | 27440402 |
| eCl@ss 8.0 | 27440402 |
| eCl@ss 9.0 | 27440402 |

ETIM

| | |
|----------|----------|
| ETIM 3.0 | EC001121 |
| ETIM 4.0 | EC002637 |
| ETIM 5.0 | EC002637 |

UNSPSC

| | |
|---------------|----------|
| UNSPSC 6.01 | 30211810 |
| UNSPSC 7.0901 | 39121409 |
| UNSPSC 11 | 39121409 |

Base strip - MSTBA 2,5/ 7-G-5,08 - 1757297

Classifications

UNSPSC

| | |
|--------------|----------|
| UNSPSC 12.01 | 39121409 |
| UNSPSC 13.2 | 39121409 |

Approvals

Approvals

Approvals

CSA / VDE Gutachten mit Fertigungsüberwachung / IECCE CB Scheme / EAC / cULus Recognized / EAC

Ex Approvals

Approval details

| | | |
|---|-------|-------|
| CSA  http://www.csagroup.org/us/en/services/testing-and-certification/certified-product-listing 13631 | | |
| | B | D |
| Nominal current IN | 15 A | 10 A |
| Nominal voltage UN | 300 V | 300 V |

| | |
|--|-------|
| VDE Gutachten mit Fertigungsüberwachung  http://www.vde.de 40004701 | |
| Nominal current IN | 12 A |
| Nominal voltage UN | 250 V |

| | |
|--|-------|
| IECCE CB Scheme  http://www.iecee.org/ DE1-56062-B1B2 | |
| Nominal current IN | 12 A |
| Nominal voltage UN | 250 V |

| |
|-------------------|
| EAC EAC-Zulassung |
|-------------------|

| | | |
|--|------|------|
| cULus Recognized http://database.ul.com/cgi-bin/XYV/template/LISEXT/1FRAME/index.htm E60425-19931011 | | |
| | B | D |
| Nominal current IN | 15 A | 10 A |

Base strip - MSTBA 2,5/ 7-G-5,08 - 1757297

Approvals

| | B | D |
|--------------------|-------|-------|
| Nominal voltage UN | 300 V | 300 V |

| |
|-------------|
| EAC B.01742 |
|-------------|

Accessories

Accessories

Coding element

Coding star - CR-MSTB - 1734401



Coding section, inserted into the recess in the header or the inverted plug, red insulating material

Filler plug

Accessories - MSTB-BL - 1755477



Keying cap, for forming sections, plugs onto header pin, green insulating material

Labeled terminal marker

Marker card - SK 5,08/3,8:FORTL.ZAHLEN - 0804293



Marker card, Card, white, labeled, Horizontal: Consecutive numbers 1 - 10, 11 - 20, etc. up to 91 - (99)100, Mounting type: Adhesive, for terminal block width: 5.08 mm, Lettering field: 5.08 x 3.8 mm

Marker pen

Marker pen - B-STIFT - 1051993



Marker pen, for manual labeling of unprinted Zack strips, smear-proof and waterproof, line thickness 0.5 mm

Base strip - MSTBA 2,5/ 7-G-5,08 - 1757297

Accessories

Terminal marking

Marker card - SK 5,08/3,8:UNBEDRUCKT - 0805412



Marker card, Card, white, unlabeled, can be labeled with: Marker pen, Mounting type: Adhesive, for terminal block width: 5.08 mm, Lettering field: 5.08 x 3.8 mm

Additional products

Printed-circuit board connector - TVMSTB 2,5/ 7-ST-5,08 - 1719053



Plug component, Nominal current: 12 A, Rated voltage (III/2): 400 V, Number of positions: 7, Pitch: 5.08 mm, Connection method: Screw connection with tension sleeve, Color: green, Contact surface: Tin

Printed-circuit board connector - FKCN 2,5/ 7-ST-5,08 - 1754610



Plug component, Nominal current: 12 A, Rated voltage (III/2): 320 V, Number of positions: 7, Pitch: 5.08 mm, Connection method: Push-in spring connection, Color: green, Contact surface: Tin

Printed-circuit board connector - MSTB 2,5/ 7-ST-5,08 - 1757064



Plug component, Nominal current: 12 A, Rated voltage (III/2): 320 V, Number of positions: 7, Pitch: 5.08 mm, Connection method: Screw connection with tension sleeve, Color: green, Contact surface: Tin

Printed-circuit board connector - MSTBP 2,5/ 7-ST-5,08 - 1769065



Plug component, Nominal current: 12 A, Rated voltage (III/2): 320 V, Number of positions: 7, Pitch: 5.08 mm, Connection method: Screw connection with tension sleeve, Color: green, Contact surface: Tin

Base strip - MSTBA 2,5/ 7-G-5,08 - 1757297

Accessories

Printed-circuit board connector - MSTB 2,5/ 7-STZ-5,08 - 1776113



Plug component, Nominal current: 12 A, Rated voltage (III/2): 320 V, Number of positions: 7, Pitch: 5.08 mm, Connection method: Screw connection with tension sleeve, Color: green, Contact surface: Tin

Printed-circuit board connector - FRONT-MSTB 2,5/ 7-ST-5,08 - 1777332



Plug component, Nominal current: 12 A, Rated voltage (III/2): 320 V, Number of positions: 7, Pitch: 5.08 mm, Connection method: Front screw connection, Color: green, Contact surface: Tin

Printed-circuit board connector - MSTBT 2,5/ 7-ST-5,08 - 1781030



Plug component, Nominal current: 12 A, Rated voltage (III/2): 320 V, Number of positions: 7, Pitch: 5.08 mm, Connection method: Screw connection with tension sleeve, Color: green, Contact surface: Tin

Printed-circuit board connector - MVSTBR 2,5/ 7-ST-5,08 - 1792294



Plug component, Nominal current: 12 A, Rated voltage (III/2): 320 V, Number of positions: 7, Pitch: 5.08 mm, Connection method: Screw connection with tension sleeve, Color: green, Contact surface: Tin

Printed-circuit board connector - MVSTBW 2,5/ 7-ST-5,08 - 1792809



Plug component, Nominal current: 12 A, Rated voltage (III/2): 320 V, Number of positions: 7, Pitch: 5.08 mm, Connection method: Screw connection with tension sleeve, Color: green, Contact surface: Tin

Base strip - MSTBA 2,5/ 7-G-5,08 - 1757297

Accessories

Printed-circuit board connector - MSTBC 2,5/ 7-ST-5,08 - 1808861



Plug component, Nominal current: 12 A, Rated voltage (III/2): 320 V, Number of positions: 7, Pitch: 5.08 mm, Connection method: Crimp connection, Color: green, Corresponding female crimp contacts with current [A] and conductor cross section range [mm²] data: 10A/MSTBC-MT 0,5-1,0 (3190564); 10A/MSTBC-MT 0,5-1,0 BA (3190645); 12A/MSTBC-MT 1,5-2,5 (3190551); 12A/MSTBC-MT 1,5-2,5 BA (3190658). BA = Bandkontakte

Printed-circuit board connector - MSTBC 2,5/ 7-STZ-5,08 - 1809556



Plug component, Nominal current: 12 A, Rated voltage (III/2): 320 V, Number of positions: 7, Pitch: 5.08 mm, Connection method: Crimp connection, Color: green, Corresponding female crimp contacts with current [A] and conductor cross section range [mm²] data: 10A/MSTBC-MT 0,5-1,0 (3190564); 10A/MSTBC-MT 0,5-1,0 BA (3190645); 12A/MSTBC-MT 1,5-2,5 (3190551); 12A/MSTBC-MT 1,5-2,5 BA (3190658). BA = Bandkontakte

Printed-circuit board connector - MSTBU 2,5/ 7-STD-5,08 - 1824175



Plug component, Nominal current: 12 A, Rated voltage (III/2): 320 V, Number of positions: 7, Pitch: 5.08 mm, Connection method: Screw connection with tension sleeve, Color: green, Contact surface: Tin, Mounting: Direct mounting

Printed-circuit board connector - MSTBU 2,5/ 7-ST-5,08-FL - 1824405



Plug component, Nominal current: 12 A, Rated voltage (III/2): 320 V, Number of positions: 7, Pitch: 5.08 mm, Connection method: Screw connection, Color: green, Contact surface: Tin, Mounting: Direct mounting

Printed-circuit board connector - SMSTB 2,5/ 7-ST-5,08 - 1826335



Plug component, Nominal current: 12 A, Rated voltage (III/2): 320 V, Number of positions: 7, Pitch: 5.08 mm, Connection method: Screw connection with tension sleeve, Color: green, Contact surface: Tin

Base strip - MSTBA 2,5/ 7-G-5,08 - 1757297

Accessories

Printed-circuit board connector - MSTBVK 2,5/ 7-ST-5,08 - 1831362



Plug component, Nominal current: 12 A, Rated voltage (III/2): 320 V, Number of positions: 7, Pitch: 5.08 mm, Connection method: Screw connection with tension sleeve, Color: green, Contact surface: Tin, Mounting: DIN rail

Printed-circuit board connector - UMSTBVK 2,5/ 7-ST-5,08 - 1833865



Plug component, Nominal current: 12 A, Rated voltage (III/2): 320 V, Number of positions: 7, Pitch: 5.08 mm, Connection method: Screw connection with tension sleeve, Color: green, Contact surface: Tin, Mounting: DIN rail

Printed-circuit board connector - TMSTBP 2,5/ 7-ST-5,08 - 1853065



Plug component, Nominal current: 12 A, Rated voltage (III/2): 320 V, Number of positions: 7, Pitch: 5.08 mm, Connection method: Screw connection with tension sleeve, Color: green, Contact surface: Tin, The plug allows conductors to be looped through from module to module.

Printed-circuit board connector - FKCV 2,5/ 7-ST-5,08 - 1873100



Plug component, Nominal current: 12 A, Rated voltage (III/2): 320 V, Number of positions: 7, Pitch: 5.08 mm, Connection method: Push-in spring connection, Color: green, Contact surface: Tin

Printed-circuit board connector - FKCVW 2,5/ 7-ST-5,08 - 1873702



Plug component, Nominal current: 12 A, Rated voltage (III/2): 320 V, Number of positions: 7, Pitch: 5.08 mm, Connection method: Push-in spring connection, Color: green, Contact surface: Tin

Base strip - MSTBA 2,5/ 7-G-5,08 - 1757297

Accessories

Printed-circuit board connector - FKCVR 2,5/ 7-ST-5,08 - 1874002



Plug component, Nominal current: 12 A, Rated voltage (III/2): 320 V, Number of positions: 7, Pitch: 5.08 mm, Connection method: Push-in spring connection, Color: green, Contact surface: Tin

Printed-circuit board connector - QC 1/ 7-ST-5,08 - 1883307

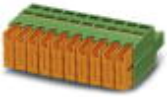

Plug component, Nominal current: 10 A, Rated voltage (III/2): 630 V, Number of positions: 7, Pitch: 5.08 mm, Connection method: Displacement connection, Color: green, Contact surface: Tin

Printed-circuit board connector - FKCT 2,5/ 7-ST-5,08 - 1902165



Plug component, Nominal current: 12 A, Rated voltage (III/2): 320 V, Number of positions: 7, Pitch: 5.08 mm, Connection method: Push-in spring connection, Color: green, Contact surface: Tin

Printed-circuit board connector - TFKC 2,5/ 7-ST-5,08 - 1962655



Plug component, Nominal current: 12 A, Rated voltage (III/2): 320 V, Number of positions: 7, Pitch: 5.08 mm, Connection method: Push-in spring connection, Color: green, Contact surface: Tin

Printed-circuit board connector - FKCS 2,5/ 7-ST-5,08 - 1975121



Plug component, Nominal current: 12 A, Rated voltage (III/2): 320 V, Number of positions: 7, Pitch: 5.08 mm, Connection method: Push-in spring connection, Color: green, Contact surface: Tin

X-ON Electronics

Largest Supplier of Electrical and Electronic Components

Click to view similar products for [phoenix contact manufacturer](#):

Other Similar products are found below :

[1203259](#) [3240366](#) [1893300](#) [2800744](#) [2867076](#) [3006564](#) [2800741](#) [5146480](#) [1582539](#) [1623633](#) [1507793](#) [3025587](#) [3069708](#) [1582223](#)
[1431461](#) [1586976](#) [0311647](#) [1460160](#) [1771338](#) [3048387](#) [2814605](#) [0309086](#) [1513716](#) [3035684](#) [5451417](#) [0202219](#) [1647747](#) [1730667](#)
[1709267](#) [5449018](#) [0311634](#) [1730696](#) [3034057](#) [0311579](#) [1730683](#) [0719032](#) [5449843](#) [3240098](#) [0311566](#) [0201391](#) [CRIMPFOX 16 S](#)
[CRIMPSET 25](#) [7001438](#) [ETD-BL-1T-F-300S](#) [MCR-1CLP-I-I-00](#) [MCR-4CLP-I-I-00](#) [MCR-DAC 8-I- 4-BUS](#) [FL EPA WMS](#) [FLK 50/EZ-DR/](#)
[400/KONFEK/S](#) [FLS PB M12 DO 8 M12-2A](#)