

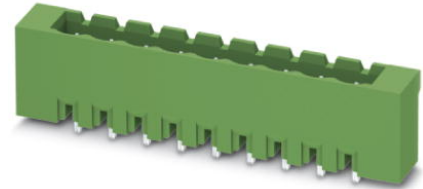

MSTBVA 2,5/ 4-G-5,08-LR

Order No.: 1809283

<http://eshop.phoenixcontact.co.uk/phoenix/treeViewClick.do?UID=1809283>

Header, Nominal current: 12 A, Rated voltage (III/2): 320 V, Number of positions: 4, Pitch: 5.08 mm, Color: green, Contact surface: Tin, Assembly: Soldering

Commercial data

EAN	 4 046356 703437
Note	Made-to-order
Pack	50
Customs tariff	85366990
Gross weight in pieces	1.99 g
Country of Origin	DE

Product notes

WEEE/RoHS-compliant since:
23/09/2011



Please note that the data given here has been taken from the online catalog. For comprehensive information and data, please refer to the user documentation at <http://www.download.phoenixcontact.com>. The General Terms and Conditions of Use apply to Internet downloads.

Technical data

Dimensions / positions

Length	8.6 mm
Height	14.6 mm
Pitch	5.08 mm
Dimension a	15.24 mm
Number of positions	4

Pin dimensions	1 x 1 mm
Hole diameter	1.4 mm
Technical data	
Range of articles	MSTBVA 2,5/..-G-LR
Insulating material group	IIIa
Rated surge voltage (III/3)	4 kV
Rated surge voltage (III/2)	4 kV
Rated surge voltage (II/2)	4 kV
Rated voltage (III/2)	320 V
Rated voltage (II/2)	400 V
Connection in acc. with standard	EN-VDE
Nominal current I_N	12 A
Nominal voltage U_N	250 V
Maximum load current	12 A
Insulating material	PBT
Inflammability class according to UL 94	V0
Color	green
Nominal voltage, UL/CUL Use Group B	300 V
Nominal current, UL/CUL Use Group B	15 A
Nominal voltage, UL/CUL Use Group D	300 V
Nominal current, UL/CUL Use Group D	15 A

Certificates

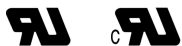

Certification

cULus Recognized

Certifications applied for:

Certification Ex:

Accessories

Item	Designation	Description
Assembly		
1755477	MSTB-BL	Keying cap, for forming sections, plugs onto header pin, green insulating material
Marking		
0804293	SK 5,08/3,8:FORTL.ZAHLEN	Marker cards, Card, white, labeled, Horizontal: Consecutive numbers 1 - 10, 11 - 20, etc. up to 91 - (99)100, Mounting type: Adhesive, For terminal block width: 5.08 mm
Plug/Adapter		
1734401	CR-MSTB	Coding section, inserted into the recess in the header or the inverted plug, red insulating material

Drawings

Drilling plan/solder pad geometry

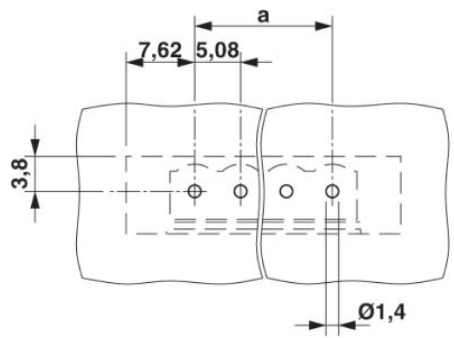

Dimensioned drawing

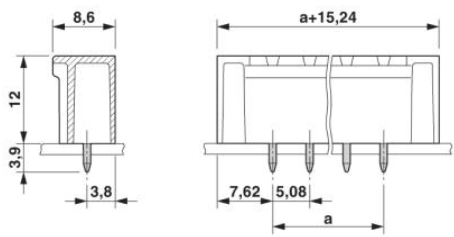

Address

PHOENIX CONTACT Ltd
Halesfield 13
Telford / Shropshire / TF7 4PG,England
Phone 01952 681 700
Fax 01952 681 799
<http://www.phoenixcontact.co.uk>



Phoenix Contact Ltd.
Technical modifications reserved;

X-ON Electronics

Largest Supplier of Electrical and Electronic Components

Click to view similar products for [phoenix contact](#) manufacturer:

Other Similar products are found below :

[1203259](#) [3240366](#) [1893300](#) [2800744](#) [2867076](#) [3006564](#) [2800741](#) [5146480](#) [1582539](#) [1623633](#) [1507793](#) [3025587](#) [3069708](#) [1582223](#)
[1431461](#) [1586976](#) [0311647](#) [1460160](#) [1771338](#) [3048387](#) [2814605](#) [0309086](#) [1513716](#) [3035684](#) [5451417](#) [0202219](#) [1647747](#) [1730667](#)
[1709267](#) [5449018](#) [0311634](#) [1730696](#) [3034057](#) [0311579](#) [1730683](#) [0719032](#) [5449843](#) [3240098](#) [0311566](#) [0201391](#) [CRIMPFOX 16 S](#)
[CRIMPSET 25](#) [7001438](#) [ETD-BL-1T-F-300S](#) [MCR-1CLP-I-I-00](#) [MCR-4CLP-I-I-00](#) [MCR-DAC 8-I- 4-BUS](#) [FL EPA WMS](#) [FLK 50/EZ-DR/](#)
[400/KONFEK/S](#) [FLS PB M12 DO 8 M12-2A](#)