

# Specialty Tools



**Plumb Bobs**  
**Pin Vises**  
**Retrieving Tools**  
**Tweezers**  
**Holding Tools**  
**Calipers**  
**Micrometers**  
**Meters**  
**Magnifiers**  
**Inspection  
Mirrors**  
**Magnetic Tools**  
**Sweepers**  
**Magnets**  
**Knives**  
**Carving Tools**  
**Grommets,  
Fasteners**  
**Punches**  
**Pliers**  
**File Sets**  
**Probe Sets**  
**Levels**

# Measure 'N Mark/Plumb Bobs

The New "Measure 'N Mark" is a pocket pen with a 3 foot removable tape measure. A handy little pen tool for those on the go. A Plumb Bob is a pointed, tapered brass or steel weight which is suspended

from a cord for determining the vertical or plumb line to a point on the ground. General's Plumb Bobs are available in a wide range of sizes and conform to government specifications.

309

## MEASURE 'N MARK

### POCKET PEN WITH REMOVABLE TAPE MEASURE

- 3' (914mm) removable tape measure
- Pen with comfort grip
- Convenient pocket clip
- Great for high-traffic areas like checkout counters and end-cap shelving
- Available only as a 15 piece counter display

UPC NO.  
02126 8 309CD Countertop Display 15 pieces  
(Sold only as a counter display - see Page T-117 for display)



Patent Pending



309CD



800

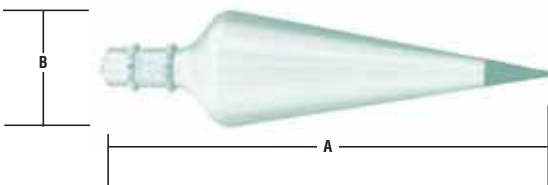

### BRASS PLUMB BOBS

- Machined of solid brass, fully polished and lacquered
- Removable self-centering cord cap for easy cord replacement. Cap used with 5/64" (0.078) braided cord
- Replaceable hardened steel point
- Conforms to government specs GGG-P-501e
- Now with extra string and tip
- 10' (3mm) long braided cord
- Available in six sizes

UPC	NO.	WEIGHT	(A)	(B)
42624 6	800-8	8 oz.	4-1/2" (114mm)	1-3/16" (30mm)
42630 7	800-12	12 oz.	5" (127mm)	1-3/8" (35mm)
42633 8	800-16	16 oz.	5-3/4" (146mm)	1-1/2" (38mm)
42639 0	800-32	32 oz.	7-1/4" (184mm)	1-7/8" (48mm)
42641 3	800NP	Replacement Point	10-33 Thread	

SPECIALTY



790



### HEXAGON STEEL PLUMB BOBS

- Made of hexagonal cold drawn steel and nickel plated to prevent rust
- Removable cord cap for 3/32" (0.094)
- 10' (3mm) long braided cord

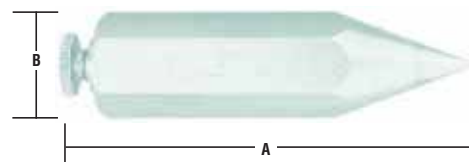

UPC	NO.	WEIGHT	(A)	(B)
42612 3	790-5	5 oz.	3-3/8" (86mm)	3/4" (19mm)
42615 4	790-8	8 oz.	4" (102mm)	7/8" (22mm)
42618 5	790-12	12 oz.	4-1/2" (114mm)	1" (25mm)



General's Pin Vises are useful for securely holding small stock, taps, drills, reamers, scribes, wire, files and other tools. The tool steel collets are hardened

and grip firmly when the screw chuck is tightened. The Swivel Head Pin Vise is an exceptional tool for precise work on models, instruments and jewelry.

### SINGLE END PIN VISE SET

- For holding small rods, wire, drills, taps and other small tools
- Tool steel collets are hardened and grip firmly when screw chuck is tightened

- Nickel plated body is hollow to permit holding of long rods of wire
- Available in individual sizes
- Conforms to government specifications GGG-V-412a

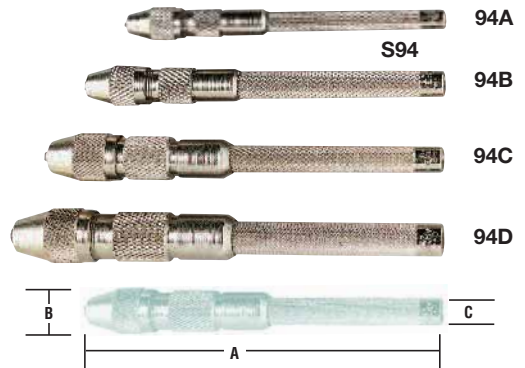

UPC	NO.	RANGE	(A)	(B)	(C)
41068 9	<b>S94</b>	Set of 4 sizes, A-D			
41074 0	<b>94A</b>	0 to 0.055" (0 to 1.4mm)	3-1/8" (79mm)	5/16" (8mm)	3/16" (5mm)
41077 1	<b>94B</b>	0.025 to 0.075" (.6 to 1.9mm)	3-1/2" (89mm)	3/8" (10mm)	1/4" (6mm)
41080 1	<b>94C</b>	0.045 to 0.125" (1.1 to 3.2mm)	3-13/16" (97mm)	7/16" (11mm)	1/4" (6mm)
41083 2	<b>94D</b>	0.110 to 0.187" (2.8 to 4.8mm)	4" (102mm)	9/16" (14mm)	5/16" (8mm)

### SWIVEL HEAD PIN VISE

- An exceptional pin vise for precise work on models, instruments and jewelry
- Two double end collets made of hardened tool steel
- Has large freewheeling swivel head
- Collets stored in handle

UPC	NO.	CAPACITY
41062 7	<b>92</b>	0.0 to 0.125" 0.0 to 3.2mm



### DOUBLE END PIN VISE

- Each end has a double end collet which may be reversed to desired size
- Nickel plated body is hollow to permit use of long wire or rods
- Collets stored in handle
- Holds a variety of small tools for fine detail work

UPC	NO.	CAPACITY
41058 0	<b>90</b>	0.0 to 0.0125" 0.0 to 3.2mm

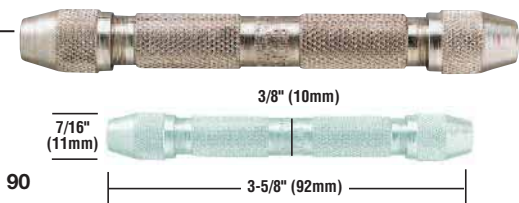

### ADJUSTABLE PIN VISE

- Use for electronic assembling, tool-making, model making and hobbies
- Holds small drills, deburrers, wires, files, reamers and other small tools
- 3-jaw hardened steel keyless chuck and sturdy plastic handle

UPC	NO.	CAPACITY
41065 8	<b>93</b>	0.040 to 0.250" 1mm to 6.4mm



### SWIVEL VACUUM VISE

- This popular vise grips firmly to glass, metal, laminate, fiberglass, or any smooth non-porous surface with quick lever action
- Universal ball joint swivels 360° to any position and tilts 90° to any angle
- V-grooved hardened steel jaws are 3" wide and open to 2-5/8"

- Furnished with slide-on rubber jaws for fragile work
- Folds for storage

UPC	NO.	SIZE	BASE HEIGHT	OVERALL WEIGHT
43960 4	<b>1850</b>	6-1/4" triangular	6-1/4"	5 lbs.

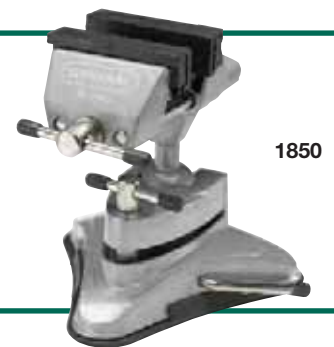

### ADJUSTABLE FILE/TOOL HANDLE

- For holding files, reamers, hacksaw blades and other tang handled tools
- Exclusive steel parallel clamping jaws grip the entire length of the inserted tang to prevent slipping
- Large, quick adjusting knurled knob ensures positive locking
- Rustproof handle with steel parts

- Conforms to government specifications NN-H-0085

UPC	NO.
43666 5	<b>890</b>





LED

The new Lighted Mechanical Pick-Ups allow you to retrieve items from dark, hard to reach places. The powerful LED light sheds a beam of light on your

subject. The strong 4-prong steel jaws allows you to retrieve small items. The shaft comes in 3 different lengths, 12", 24", and 36".

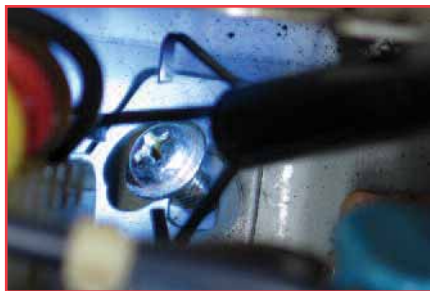

### LIGHTED MECHANICAL PICK-UPS

- Retrieve items from dark/hard-to-reach places
- Push On Powerful LED light
- Continued push opens retrieval claw
- Comfortable ergonomically designed hand controls
- Flexible shaft

- Strong spring steel retrieval claw
- Power Source: 3 "LR41" batteries (included)

UPC	NO.
70399 6	70393 12" OAL
26003 1	70396 24" OAL
70393 4	70399 36" OAL

LR41 replacement battery

**ULTRA**TECH<sup>™</sup>  
LED VISION<sup>™</sup>



### MINI MECHANICAL PICKUP

- Strong four prong steel jaws retrieve small objects up to 1/2" (12mm)
- Knurled body with tapered point for hard-to-reach work areas
- Smooth traveling plunger actuator for greater control
- Chrome finish to prevent rust
- Can be used as a screw starter

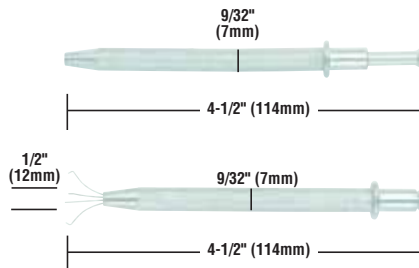

388

UPC	NO.
42214 9	388



### MECHANICAL PICKUP

- Strong four prong steel jaws retrieve small items from hard-to-reach places
- Smooth actuator for greater control

- Chrome finish to prevent rust
- Flexible shaft to avoid obstacles

UPC	NO.
22145 2	396

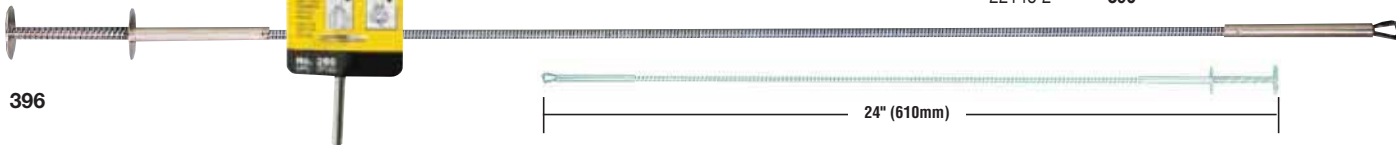

396



400

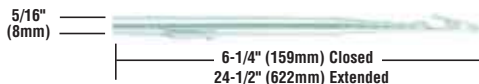

### TELESCOPING ALLIGATOR CLIP

- Ideal for lighting pilot lights and barbeques
- Jaw capacity: .170" (4.30mm)
- Chrome finish to prevent rust
- Convenient pocket-clip

UPC	NO.
42217 0	400

SPECIALTY



Utility Tweezers are used by mechanics, craftspeople and hobbyists where value is desired. The Nut Starter and Screw Starters are used for starting and removing nuts and screws in hard-to-reach

places. They can also be used when nuts and screws are too small to be held by hand while being threaded.

**INDIVIDUAL STYLES OF UTILITY TWEEZERS**

**UTILITY TWEEZERS.** Utility tweezers for mechanics, craftspeople and hobbyists

UPC	NO.	POINT STYLE	LENGTH
42291 0	414	Blunt serrated (self closing)	6-1/2"
42294 1	415	Curved	6-1/2"
42297 2	416	Spade	4-1/2"



**SWISS PATTERN TWEEZERS**

- Light tension and hardened points for subminiature assemblies
- Stainless steel construction
- Finest quality precision points

UPC	NO.	POINT STYLE	LENGTH
42249 1	423-3	Very fine	4-5/8"
42251 4	423-3C	Very fine	4-1/8"

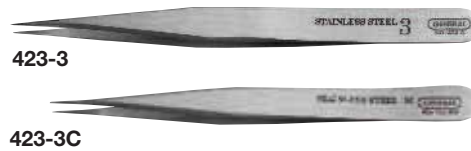

**SIX-PIECE TWEezer SET**

- Consists of six tweezers for home and industrial use
- One each of Nos. 401XX, 403, 412, 414, 415, 417
- In clear vinyl pouch

UPC	NO.
42309 2	C421



**TWEezer MAGNIFIER**

- Useful for detailed projects
- 5-power lens
- Stainless steel tweezers
- Double hinged adjustable arm

- Durable plastic handle and frame
- Finely ground points
- Length 2-1/4" (57mm)

UPC	NO.
42258 3	425



**NUT STARTER**

- For starting or removing threaded nuts in hard-to-reach areas. Can also be used when nuts are too small to be held by hand while being threaded
- Easy-to-use spring steel chuck will hold nut sizes from 3-48 thread (3/32" or 2.5mm) to 5/16" (8mm)

- Knurled aluminum handle

UPC	NO.
42682 6	8081



**SLOTTED SCREW STARTER**

- For starting or removing slotted screws in hard-to-reach areas. Can also be used when screws are too small to be held by hand while being threaded
- Spring loaded steel chuck holds slotted screws from No. 3 to 7/16" sizes

- Knurled aluminum handle

UPC	NO.
42684 0	8082



**CROSS POINT SCREW STARTER**

- For starting or removing cross point screws in hard-to-reach areas. Can also be used when screws are too small to be held by hand while being threaded
- Easy-to-use spring steel chuck holds screws from No. 6 to 1/4" size

- Knurled aluminum handle

UPC	NO.
42686 4	8083

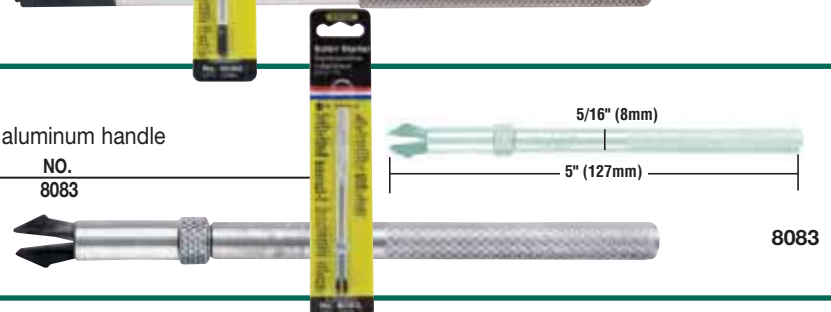

# Lighted Tools

## Shed Some Light On Your Subject



with Lighted Tweezers and Lighted Mechanical Pick-Up

### Lighted Tweezers

**1**  
Push On /  
Push Off  
Powerful  
LED Light

**2**  
Non-Slip  
Comfort  
Grips

**3**  
Heat  
Treated  
Steel

**4**  
Corrosion  
Resistant  
Non-Glare  
Black Finish

**5**  
Serrated  
Blunt Tips  
6.25" (159mm)  
No. 70403

Serrated  
Bent Tips  
6.5" (165mm)  
No. 70408

Smooth  
Pointed Tip  
6.25" (159mm)  
No. 70401



Blunt Tip  
No. 70403

Includes 3 "LR41" batteries



Bent Tip  
No. 70408

Pointed Tip  
No. 70401

POWERFUL LED LIGHT



No. 70400  
3 Piece Set  
70401, 70403,  
70408

No. 70402  
2 Piece Set  
70401, 70408

### 24" Lighted Mechanical Pick-up

**1**  
Push On  
Powerful  
LED Light

**2**  
Continued  
Push Opens  
Retrieval Claw

**3**  
Comfortable  
Hand Controls

**4**  
Corrosion  
Resistant  
Black Finish

**5**  
FLEXI-SHAFT™  
Lighted  
Mechanical  
Pick-Up  
No. 70393  
12" (305 mm)  
No. 70396  
24" (610 mm)  
No. 70399  
36" (914 mm)

**5**  
FLEXI-SHAFT™

**6**  
Strong Retrieval  
Claw Can Grasp  
Objects Up To  
1" (52mm)

Includes  
3 "LR41"  
batteries

**6**



The new Lighted Tweezers allow you to retrieve items from dark, hard-to-reach places. The powerful LED light allows you to put the light exactly where you need it. Ideal for electronics, computer,

instrument, radio and other small or sub-miniature assembly, servicing and repairs. Available in three tip configurations.

**LIGHTED TWEEZERS**

Now, put the light exactly where you need it!

- Push ON/Push OFF powerful LED light
- Non-slip comfort grip
- Heat treated steel
- Corrosion resistant non-glare black finish
- Tweezers are approximately 6.25" (159mm) long
- Sets come with heavy-duty Ballistic nylon carrying case
- Power Source: 3 "LR41" batteries per tweezer (included)

UPC	NO.	
26004 8	70401	Smooth Point Tip
26005 5	70403	Serrated Blunt Tip
26006 2	70408	Serrated Bent Tip
70402 3	70402	(2 pc. set) 70401, 70408
70400 9	70400	(3 pc. set) 70401, 70403, 70408



70401

Smooth Point Tip



70403

Serrated Blunt Tip



70408

Serrated Bent Tip

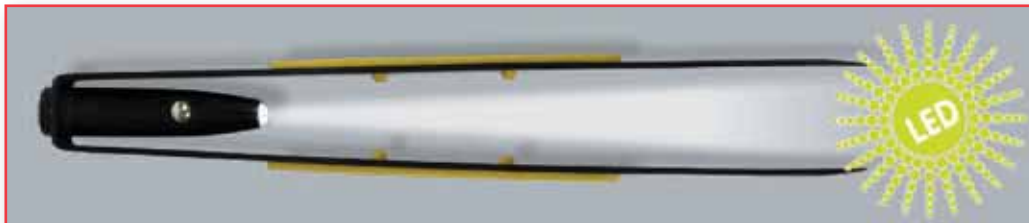

**PRECISION TWEEZERS.** For electronic, computer, instrument, radio and other small or subminiature assembly, servicing and repairs

**BOLEY PATTERN TWEezer**

- A fine quality tweezer for jewelers, watch-makers, instrument assemblers and crafts-people
- For radio, television and other repairs

UPC	NO.	POINT STYLE	LENGTH
42240 8	401AA	Strong bevel	5"



401AA

**INDUSTRIAL TWEEZERS.** General's quality tweezers for toolmakers, repairmen, electronic assemblers and other professionals

**INDIVIDUAL STYLES OF INDUSTRIAL TWEEZERS**

UPC	NO.	POINT STYLE	LENGTH
42263 7	401XX	Strong sharp	4-1/2"
42266 8	403	Blunt serrated	6"
42271 2	408	Sharp bent	4-1/4"
42280 4	410	Narrow sharp	4-1/4"



401XX



408



403



410

# FRACTION+™

## Digital Fractional Caliper

Light Weight Non-Marring  
Carbon Fiber Construction

### 3 Mode Digital Display

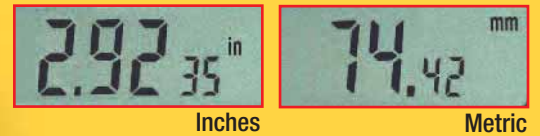

Inches      Metric



Fractions

2 Sizes Now Available  
3" (76mm) / 6" (150mm)

3" Fraction+ Caliper  
Clips into Your Pocket

Convenient Auto  
On/Off Feature



#### Specifications:

##### Range:

No. 1433 (3")  
0 - 3" (0-76mm)

No. 146 (6")  
0 - 6" (0 - 150mm)

##### Accuracy:

No. 1433 (3")  
+/- 0.005", +/- 0.1mm

No. 146 (6")  
+/- 0.008", +/- 0.2mm

##### Resolution:

0.0005"  
0.01mm  
1/64"

##### Repeatability:

0.0005"  
0.01mm  
1/64"

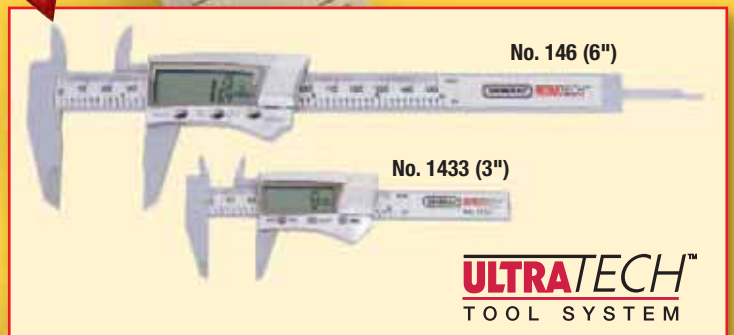

From the Hobbyist  
to the Technician and  
Measuring Everything  
in Between







# FRACTION+

## The Digital Fractional Caliper Family

### FRACTION+

#### 6", 8" & 12" STAINLESS STEEL DIGITAL FRACTIONAL CALIPERS

- 6" (153mm) range
- Heavy-duty stainless steel construction
- Convenient auto-off feature
- Three mode digital display: Decimal Inches, Fractions, Metric
- Inside, outside, depth & step measurements
- Accuracy: +/- 0.001", +/- 0.02mm
- Resolution: 0.0005", 0.01mm, 1/64"
- Power Source: 1 "SR44" (1.5V) battery (included)



UPC	NO.	RANGE
01470 2	147	0 - 6" (0 - 153mm)
01478 3	1478	0 - 8" (0 - 203mm)
14712 7	14712	0 - 12" (0 - 305mm)



No. 147 Digital Display

### FRACTION+

#### 6" CARBON FIBER DIGITAL FRACTIONAL CALIPER

- 6" (153mm) range
- Lightweight, non-marring carbon fiber composite
- Convenient auto-off feature
- Three mode digital display: Decimal Inches, Fractions, Metric
- Inside, outside, depth & step measurements
- Accuracy: +/- 0.008", +/- 0.2mm
- Resolution: 0.0005", 0.01mm, 1/64"
- Power Source: 1 "SR44" (1.5V) battery (included)



No. 146 Digital Display

### FRACTION+

#### 3" CARBON FIBER DIGITAL FRACTIONAL CALIPER

- 3" (76mm) range
- Lightweight non-marring carbon fiber composite
- Convenient auto-off feature
- Three mode digital display: Decimal Inches, Fractional and Metric
- Convenient pocket clip
- Inside, outside, depth & step measurements
- Accuracy: +/- 0.005", +/- 0.1mm
- Resolution: 0.0005", 0.01mm, 1/64"
- Power Source: 1 "SR54" (1.5V) silver oxide battery (included)



No. 1433 Digital Display

UPC	NO.	RANGE
01433 7	1433	0 - 3" (0 - 76mm)

SPECIALTY

# SPECIALTY TOOLS

## Dial Calipers



General's high quality, easy-to-read Dial Calipers give precise readings – Inside, Outside, Depth and Step measurements. The 6" Plastic Dial Caliper is made of fiberglass reinforced plastic and gives

precision measurements at an economical price. The 6" Dial Caliper is a stainless steel construction for greater accuracy and durability.



### 6" PLASTIC, DIRECT READING DIAL CALIPER



142

- Fiberglass reinforced plastic gives precision measurements at an economical price
- Measuring capacity 0 to 6"
- Contrasting color coded dial is graduated in .01" and 64ths with inch and mm on bar scale
- No-glare easy-to-read dial with adjustable bezel

- Inside, outside, depth and step measurements
- Freewheeling friction roller for repetitive and accurate readings
- Fractional conversion table on back

UPC	NO.
44145 4	142

### 6" DIAL CALIPER



107

- Stainless steel construction for accuracy and durability
- Large, clear dial accurately reads to .001"
- Satin chrome scale with clearly etched tenths of inch graduations
- Covered rack ensures smooth operation by preventing dirt and chips from entering rack and gear mechanism

- Inside, outside, depth and step measurement
- Lock for repetitive measurement
- Free wheeling thumb roller
- Depth stop rod
- Adjustable bezel for zero setting

UPC	NO.
10700 8	107

### DIAL CALIPER AND MARKING SET



108

- This set contains three of the most useful measuring and marking tools for mechanics and machinists
- Set includes: 6" Dial Caliper; 6" x 3/4" Stainless Steel Rule with satin finish and reversible Tip Carbide Scriber with magnetic pick-up
- Rule has etched and filled 4 graduations (1/8", 1/16", 1/32", 1/64")

- Scriber has aluminum body with knurled handle with an overall length of 4-3/4"
- Caliper has inside, outside, depth and step measurements
- Caliper has lock for repetitive measurement
- Caliper has free wheeling thumb roller
- Packaged in a sturdy, fitted, plastic case designed specifically for this set

UPC	NO.
10800 5	108

### 6" PLASTIC DIAL CALIPER, THOUSANDTHS READING, SINGLE REVOLUTION

- Capacity 0 to 6"
- Readings in .001"
- Single revolution of dial is .100"
- Resolution .001"
- 6" scale is graduated in tenths/mm
- Non-glare dial with adjustable bezel
- Packed in reusable plastic hang-up case

- Inside, outside, depth and step measurements
- Freewheeling friction roller for repetitive and accurate readings

UPC	NO.
44150 8	145



145

### PLASTIC, METRIC DIAL CALIPER

- Capacity 0 to 150mm by 0.1mm
- Accurately graduated dial has direct readings in metric 0.1mm
- Complete with instructions and reusable plastic hang-up case
- Inside, outside, depth and step measurements

- Freewheeling friction roller for repetitive and accurate readings

UPC	NO.
44148 5	144MM



144MM

SPECIALTY

# Calipers/Micrometers



Slide Calipers come in different styles - Electronic Digital Calipers, Mechanical Dial Calipers, Vernier Calipers and Plain Slide Calipers. General's all-purpose Slide Calipers, sized to slip into your pocket, can

make quick, accurate, inside and outside diameter measurements. General's Utility Micrometer is a practical and economical measuring device for beginners as well as hobbyists.

## METRIC AND ENGLISH VERNIER CALIPER

- Graduated in mm and 16ths of an inch with vernier reading of .1mm and 1/128"
- Economical steel vernier calipers have 5" (125mm) capacity
- Inside and outside jaws and full length depth gage
- Caliper has inside, outside depth and step measurement

- Caliper has lock for repetitive measurement
- Friction roller adjustment
- Slide lock for gaging

UPC	NO.
42577 5	722



722

## 4-INCH SLIDE CALIPERS

- Stainless steel caliper with inside and outside readings in 16ths and 32nds
- Decimal equivalents table on back
- Scale has etched and filled graduations
- 4" (102mm) capacity

UPC	NO.	GRADS
42581 2	729	16ths and 32nds
42594 2	729ME	mm and 16ths



729

## POCKET CALIPER

- Stainless steel slide caliper with inside and outside readings in metric and inches
- Decimal equivalents on back
- Scale has etched and filled graduations
- 3" (76mm) capacity

UPC	NO.	GRADS
44136 2	132ME	32nds and mm

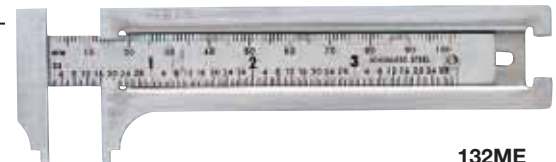

132ME

## POCKET CALIPER

- Precision made high strength, fiberglass reinforced plastic caliper
- Opens to 3" (76mm) outside measurement capacity
- 4" (102mm) rule graduated in 16ths on back
- Inside and outside readings graduated in 32nds and mm

UPC	NO.	GRADS
44139 3	141ME	32nds and mm



141ME

## UTILITY MICROMETER

- A practical and economical measuring device for beginners and hobbyists
- Well-suited for use in training programs, general toolroom and machine shop use and automotive work
- Accuracy guaranteed to .001"
- Special wrench is included for simple zero adjustments

- Ground and polished carbide measuring faces
- Engraved graduations on barrel
- Lock for repetitive measurement

UPC	NO.	RANGE INCLUDES
44103 4	102	0" to 1"



102



The Precision Measuring Kit contains four of the most useful measuring and marking tools for mechanics and machinists: Micrometer, Dial Caliper, 6" Steel

Rule and Carbide Scriber. The Marking Kit contains a 6" Steel Rule, Magnetic Pick-Up, Automatic Center Punch and Scriber.



S004

### PRECISION MEASURING KIT

- This kit contains four of the most useful measuring and marking tools for mechanics or machinists
- Kit includes: No. 102, 0 to 1" micrometer; No. 145, 0 to 6" thousandths reading dial caliper; No. 676, 6" rigid stainless steel rule graduated in 8ths, 16ths, 32nds, and 64ths; No. 88CM, tungsten carbide scriber with magnetic pickup

- Packaged in sturdy, fitted, blow molded case designed specifically for these tools
- Instructions and conversion table (fractions to decimals to millimeters) included

UPC	NO.
34106 8	S004



109



### PLUNGER DIAL INDICATOR

- Large 2-1/4" (57mm) diameter dial indicator
- Accuracy to .001"
- Dial is continuous and may be rotated for setting at any point
- Full 1" travel
- Revolution accumulator counter
- Direct decimal two-way reading left and right
- Adjustable limit indicators
- Lug mount standard

UPC	NO.	READINGS
10900 2	109	0 to .001" by .001"



### POCKET PROTECTOR TOOL/MARKING KIT

- This handy pocket size tool kit is designed for the mechanic, machinist or hobbyist
- The kit contains four of General's best selling tools: No. 300/1, 6" rule; No. 383NX, telescoping magnetic pickup; No. 87, automatic center punch and No. 88, scriber
- All tools packaged in vinyl pocket protector which can be snapped closed

UPC	NO.	KIT INCLUDES ONE EACH:
34112 9	S008	6" rule, magnetic pickup, automatic center punch, scriber



General's NEW **LumiLENS™** Lighted Magnifier puts the light directly on your subject to be viewed. With its powerful extra bright LED light you will never be left in the dark again. Two lens magnifications,

3x and 6x, as well as an integrated stand for Hands-Free use make this tool a must in laboratory quality control, inspection and assembly functions.



• Hands-Free Use



• 3x Magnification, 6x Inset Lens



• Extra-Bright LED



800543



**LumiLENS™**  
**LIGHTED MAGNIFIER**

- Push On / Push Off Powerful LED light
- Contoured Handle for Handheld Use
- Integrated Stand for Hands-Free Use
- Shatter-Resistant Lens
- 3-1/2" Lens Diameter (89mm)
- 3X Magnification (6X Inset lens)
- Power Source: 2 "AA" batteries (included)

UPC	NO.
26001 7	800543

**ULTRATECH™**  
**LED VISION™**

**4 POWER POCKET ILLUMINATED MAGNIFIER**

- Handy 4 power magnifier has plastic body and lens
- Power Source: "AAA" batteries and No. 222 bulb (included)

UPC	NO.	POWER
42456 3	553	4



553

**4" ILLUMINATED MAGNIFIER**

- 4" diameter with 3 power lens covers large areas of print
- 5 power bifocal lens insert gives even greater magnification
- Bulb gives wide circle of illumination
- Plastic body and optical plastic lens
- Power Source: 2 "C" batteries (included)

UPC	NO.	POWER	FOCAL LENGTH
42462 4	554	3.0	3-1/3"
	Bifocal	5.0	2"



554



General's Magnifiers are used by toolmakers, jewelers, instrument assemblers, laboratory technicians, engineers, mechanics and inspectors who need sharp clear magnification without eyestrain. These

magnifiers are designed for demanding jobs in laboratory quality control, inspections and assembly functions. The Illuminated Magnifiers are of the highest optical quality and offer fine resolution.



750545



700540

### ULTRATECH™ GLASS MAGNIFIERS

- Polished optical glass lens with a metal frame
- Versa-Grip™ Handle with non-slip cushion grip
- Full range of sizes from 2" (50mm) to 4-1/2" (115mm)
- Round lens is distortion free
- A powerful magnifier for working in confined or obstructed spaces
- Designed for demanding jobs in laboratory quality control, inspection and assembly functions
- Used by engineers, mechanics, inspectors, lab technicians, toolmakers, instrument assemblers, jewelers, do-it-yourselfers, hobby and crafts people

UPC	NO.	DIAMETER	POWER	FOCAL LENGTH
00540 3	700540	2" (50mm)	1.6	6"
50541 5	750541	2-1/2" (65mm)	1.6	6"
50542 2	750542	3" (75mm)	1.6	6"
50543 9	750543	3-1/2" (90mm)	1.25	8"
50544 6	750544	4" (100mm)	1.25	8"
50545 3	750545	4-1/2" (115mm)	1.25	8"



538

### 2" MAGNIFIER

- Economical and versatile magnifier for laboratory and industrial uses, for do-it-yourselfers, mechanics and inspectors
- 2" diameter with 4 power lens

- Lightweight, durable 1-piece molded plastic frame

UPC	NO.	POWER	FOCAL LENGTH
42414 3	538	4	2"



565

### RECTANGULAR ILLUMINATED MAGNIFIER

- Lens measures 2" x 4" for distortion-free magnification of large areas
- Reversible light reflector adapts for right- or left-hand use
- 2.5 power shatterproof lens, with 5 power bifocal insert

- Replaceable bulb and 2 "AA" batteries are included

UPC	NO.	POWER	FOCAL LENGTH
42509 6	565	2.5	4"
	Bifocal	5.0	2"



1050

### ADJUSTABLE ILLUMINATED MAGNIFIER

- Epoxy coated steel rod stand has adjustable lens for factory, industrial and hobby use
- Illumination: 7 watt bulb
- 6 ft. cord plugs into 110-120V AC. UL listed
- Big lens - 4" (102mm) diameter
- Small lens - 0.8" diameter
- 3x magnifier with 6x spot lens

UPC	NO.	POWER
43750 1	1050	3x (Big lens) 6x (Small Lens)

SPECIALTY



General's Magnifiers are used by toolmakers, jewelers, instrument assemblers, laboratory technicians, engineers, mechanics and inspectors who need sharp clear magnification without eyestrain. These

magnifiers are designed for demanding jobs in laboratory quality control, inspections and assembly functions. Our magnifiers are of the highest optical quality and offer fine resolution.

**2.5 POWER POCKET MAGNIFIER**

- Has 2.5 power ground and polished optical glass
- Folds into case for storage

UPC	NO.	POWER	FOCAL LENGTH
42400 6	532	2.5 Simulated	4"
Black Leather case			



532

**EYE LOUPE**

- For toolmakers, jewelers, instrument assemblers and others who need sharp, clear magnification without eyestrain
- Clear optical glass lens is ground and polished
- 1" diameter lens

UPC	NO.	POWER	FOCAL LENGTH
42339 9	527	5.0	2"



527

**FOLDING POCKET MAGNIFIERS**

- Fine quality magnifiers for laboratory technicians, engineers, mechanics and inspectors
- Case and lens rims are made of black molded plastic
- Available in single lens and double lens models

UPC	NO.	IND. MOD.	TOT. POW.	LENS POW.	FOCAL DIA.	LENGTH
42403 7	533	Sing.	4.0	4.0	1"	2.5"
42409 9	536	Dble.	4.0	8.0	1"	1.25"
42412 9	537	Dble.	3.0	6.0	1-1/4"	1.6"



533



536

**BINOCULAR MAGNIFIER**

- For assemblers and inspectors of electronic and other small or subminiature parts, toolmakers, jewelers and engravers
- Leaves hands free to work
- Ground and polished optical lenses eliminate eyestrain
- Tilt-up lens frame
- Fits over prescription glasses

UPC	NO.	POWER	FOCAL LENGTH
43734 1	950-5	2.25	8"



950

# SPECIALTY TOOLS

## Mirrors/Mini Lights



The Mini-Light has an LED light bulb which has a life of 100,000 hours of continuous use. These lights require 4 "LR41" batteries which have a life of 48 continuous hours. The Mini's come with either

a telescoping handle which extends up to 28-3/4" (720mm) or with an alligator clip which clips on anything, anytime, anywhere for instant, direct light.

MB560



### MAGNETIC BASE INSPECTION MIRROR

- Adjustable 3-1/2" x 2" oblong glass inspection mirror mounted to a permanent magnet
- Attaches to any steel or iron machine, tool, appliance or other equipment
- Has wing nut ball joint adjustment

UPC	NO.
42475 4	MB560

580



### "LITE-IT" CLIP-ON MINI-LIGHT

- Clips on to anything, anytime, anywhere for instant, direct light
- Light is fastened to a rugged high-impact ABS plastic Alligator Clip with a double ball joint that adjusts to any angle
- 4 Alkaline, "LR41", batteries with a battery life of 48 continuous hours
- LED bulb has a life of 100,000 hours of continuous use

UPC	NO.	PKG.
58001 6	580	Carded



759582



### TELESCOPING MINI-LIGHT WITH MAGNETIC PICK-UP

- Mini Light with 2 lb. Neodymium Magnetic pick-up are both fastened to a stainless steel telescoping wand molded into a rugged high-impact ABS plastic handle
- Telescopes from 7-3/4" - 28-3/4" (197mm - 720mm)
- 4 Alkaline, "LR41", batteries with a battery life of 48 continuous hours
- LED bulb has a life of 100,000 hours of continuous use
- Has a 2 lb. smooth surface pull capacity Neodymium donut magnet
- Precision engineered 750 Series Versa-Grip™ handle for maximum performance

UPC	NO.	PKG.
75966 5	759581	Carded
75967 2	759582	Carded

582



### TELESCOPING MINI-LITE WITH MAGNETIC PICK-UP

- A powerful permanent magnetic pick-up tool
- Ideal for retrieving steel and iron parts from hard-to-reach and see work areas
- Magnet is fitted in a 5-1/2" (140mm) long ergonomically designed handle
- 4 Alkaline, "LR41", batteries with a battery life of 48 continuous hours
- Light Bulb has a life of 100,000 hours of continuous use
- Mini-Light is fastened to a chrome plated brass wand with a double ball joint
- Ball and socket feature for simple, positive adjustments

UPC	NO.	PKG.
05820 1	582	Carded

759563



### 2-1/2" ROUND TELESCOPING 3X POWER MAGNIFYING MIRROR

- For the inspection of obstructed and hard to see objects
- High quality 2-1/2" (64mm) diameter magnifying glass mirror improves visibility
- High strength corrosion resistant stainless steel wand extends from 8-1/2" to 29" (216mm - 737mm)
- Precision engineered 750 Series Versa-Grip™ handle for maximum performance

UPC	NO.	PKG.
75959 7	759563	Carded



Inspection Mirrors facilitate inspection of inaccessible workpieces and machines by toolmakers, assemblers, inspectors and mechanics. Fully polished mirrors are enclosed in plated holders

which are attached to knurled handles with ball and socket joints. Telescoping arms and vinyl cushion grip handles are offered on some mirrors.



**TELESCOPING LIGHTED INSPECTION MIRROR**

- 2 Extra bright LED lights facilitate the inspection of hard-to-see and hard-to-reach areas
- Ideal for toolmakers, machinists, inspectors and mechanics
- Fully polished glass mirror is shatter-resistant
- 2 "CF2032" batteries included
- 360° Swivel double ball joint

UPC	NO.	SIZE	OVERALL LENGTH
02146 5	80560	2" x 3"	12-1/4", extends to 33"



80560

**LONG TELESCOPING INSPECTION MIRROR**

- Handle has black cushion grip
- Non-slip grip
- Mirror size: 2" diameter
- 36" telescoping

UPC	NO.
05590 3	559



559

**METAL INSPECTION MIRRORS**

- Includes plastic protective sheath
- Heavy-duty construction

UPC	NO.	SIZE	OVERALL LENGTH
05531 3	5561	1-1/4" x 2"	9-3/4", extends to 26"
05562 0	5562	2" x 3-3/4"	10-3/4", extends to 26"
05563 7	5563	3-3/4" dia.	9-3/4", extends to 26"



5562

5561

5563

**GLASS INSPECTION MIRRORS**

- These mirrors facilitate inspection of inaccessible workpieces and machines by toolmakers, assemblers, inspectors and mechanics
- Fully polished glass mirrors are enclosed in plated holders which are attached to knurled handles with ball and socket joints
- Nos. 557, 577, 560, and 570 have telescoping arms and vinyl cushion grip handles

UPC	NO.	SIZE	OVERALL LENGTH
42465 5	555	1-1/4" dia.	8"
42468 6	557	2-1/4" dia.	10-1/2", extends to 15"
42471 6	558	1" x 2" oval	9"
42473 0	560	3-1/2" x 2" oblong	11-1/2", extends to 16"

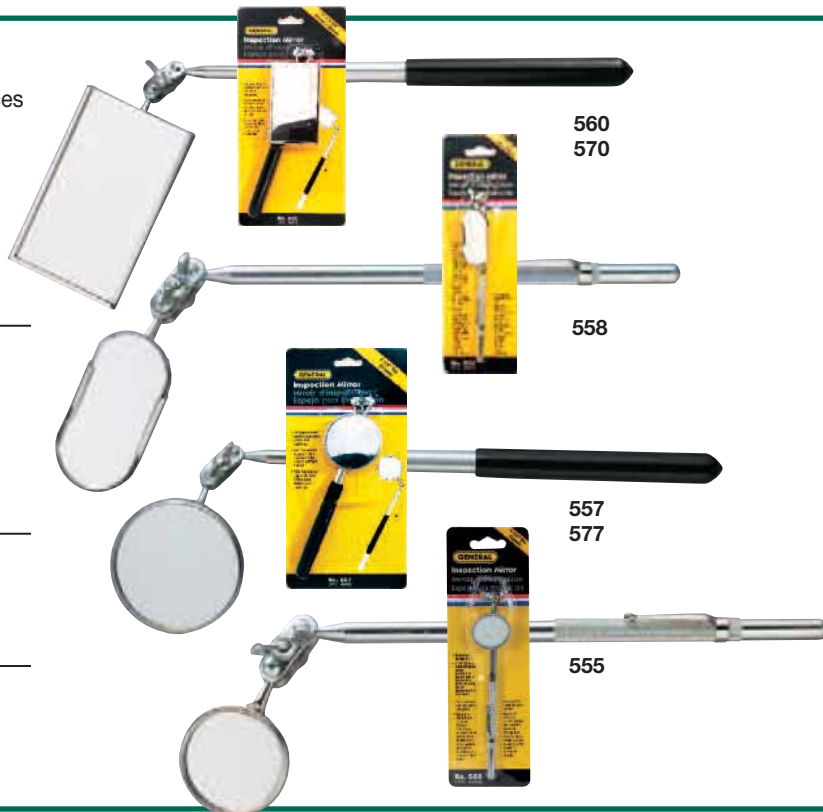

560  
570

558

557  
577

555

**ACRYLIC PLASTIC INSPECTION MIRRORS**

UPC	NO.	SIZE	OVERALL LENGTH
42480 8	577	2-1/4" dia.	10-1/2" - 15"
42477 8	570	3-1/2" x 2"	11-1/2" - 16"

**REPLACEMENT MIRRORS WITH FRAMES**

UPC	NO.
42478 5	557RMF for No. 557
42484 6	560RMF for No. 560 and No. MB560

# SPECIALTY TOOLS

## Inspection Mirrors



Inspection Mirrors facilitate inspection of inaccessible workpieces and machines by toolmakers, assemblers, inspectors and mechanics.

Fully polished mirrors are enclosed in plated holders which are attached to ergonomically designed handles with ball and socket joints.

DOUBLE BALL JOINT CONNECTION PERMITS INFINITE ANGLE ADJUSTMENTS



HIGH STRENGTH CORROSION RESISTANT STAINLESS STEEL TELESCOPING WAND

ERGONOMICALLY DESIGNED HANDLE WITH CONTOURED HEAD FOR GREATER CONTROL AND COMFORT

EIGHT SIDED CUSHION GRIP HAS A NON-SLIP SURFACE

RUGGED HIGH IMPACT ABS PLASTIC HANDLE

ROTATING CAP FACETS FIT PALM



### UTILITY TELESCOPING INSPECTION MIRRORS

- These mirrors facilitate inspection of inaccessible work pieces and machines by toolmakers, assemblers, inspectors and mechanics
- Fully polished mirrors are enclosed in plated holders which are attached to handles with a double ball and socket joint
- Double ball and socket joints adjust to any angle
- Nos. 70557 have telescoping arms and vinyl cushion grip handles

UPC	NO.	SIZE	OVERALL LENGTH
22344 9	70555	1-3/8" dia.	5" extends to 27-1/2"
22347 0	70557	2-1/4" dia.	9-3/4" extends to 14-3/4"



70557



70555



759575

### 1-1/2" ROUND PLASTIC TELESCOPING MIRROR

- For the inspection of obstructed and hard to see objects
- High performance 1-1/2" (38mm) diameter Lexan™ mirror resists scratching and shattering

- High strength corrosion resistant stainless steel wand extends from 7-5/8" to 28" (194mm - 711mm)
- Precision engineered 750 Series Versa-Grip™ handle for maximum performance

UPC	NO.	PKG.
75957 3	759575	Carded

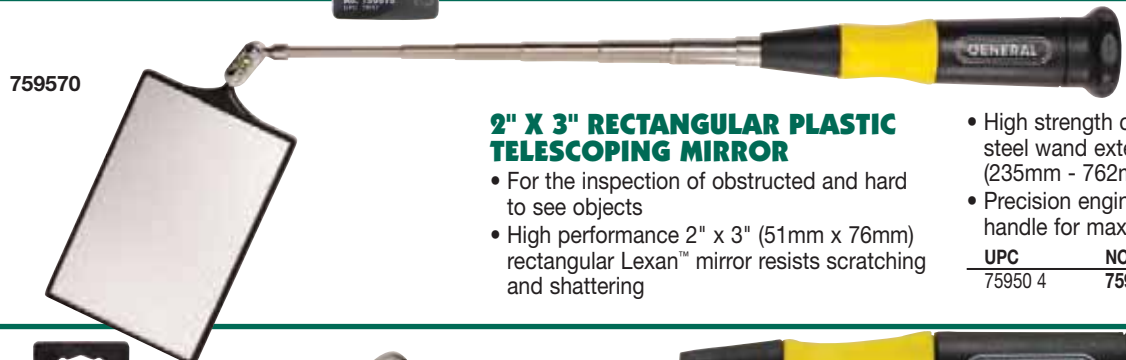

759570

### 2" X 3" RECTANGULAR PLASTIC TELESCOPING MIRROR

- For the inspection of obstructed and hard to see objects
- High performance 2" x 3" (51mm x 76mm) rectangular Lexan™ mirror resists scratching and shattering

- High strength corrosion resistant stainless steel wand extends from 9-1/4" to 30" (235mm - 762mm)
- Precision engineered 750 Series Versa-Grip™ handle for maximum performance

UPC	NO.	PKG.
75950 4	759570	Carded



1 1/2"

709575

### 1-1/2" ROUND PLASTIC, FIXED LENGTH, INSPECTION MIRROR

- For the inspection of obstructed and hard to see objects
- High performance 1-1/2" (38mm) diameter Lexan™ mirror resists scratching and shattering

- High strength stainless steel shaft resists corrosion
- Overall length is 8" (203mm)
- Precision engineered 700 Series Versa-Grip™ handle for maximum performance

UPC	NO.	PKG.
70972 1	709575	Carded

SPECIALTY



**TELESCOPING *Speed-Chuck*™ INSPECTION SETS**

- Stainless Steel *Speed-Chuck*™ and telescoping wand combination provides quick and limitless inspection and retrieval solutions
- Ergonomically designed handle with contoured head for greater control and comfort
- Handle telescopes from 6-3/8" (163mm) to 26" (660mm)
- Spring-loaded *Speed-Chuck*™ allows blade changes instantly
- All attachments are fastened to a stainless steel *Speed-Chuck*™ adapter with a double ball joint, adjusts to any angle
- Precision Locking System firmly holds blades in place
- Available attachments:
  - Neodymium magnets: 2 lb., 5 lb. and 10 lb. smooth surface pull capacities
  - Mirrors & Magnifiers: 1-1/2" (38mm) diameter • 2" x 3" (51mm x 76mm) rectangular mirror • 2-3/8" (60mm) dia. 3x power magnifying mirror
  - 2-1/2" (64mm) dia. 3x power magnifier;
  - Alligator clip • Mini-Lite
- All sets are securely and safely protected within a fitted zippered case

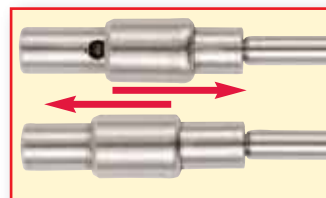

**3-PIECE TELESCOPING "SPEED-CHUCK"™ INSPECTION SET**

- Set includes: • 26" stainless steel telescoping wand with *Speed-Chuck*™ handle • 2 lb. magnetic pick-up • 1-1/2" round plastic mirror • Mini-Lite • Batteries included
- Precision engineered 750 Series Versa-Grip™ handle for maximum performance

UPC	NO.	PKG.
75960 3	759903	Zippered Case/Boxed

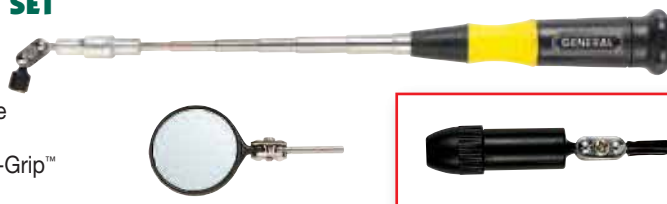

759903

**5-PIECE TELESCOPING "SPEED-CHUCK"™ INSPECTION SET**

- Set includes: • 26" stainless steel telescoping wand with *Speed-Chuck*™ assembly • 5 lb. magnetic pick-up • 2" x 3" rectangular plastic mirror • 3x power magnifier, alligator clip • Mini-Lite. Batteries included
- Precision engineered 750 Series Versa-Grip™ handle for maximum performance

UPC	NO.	PKG.
75961 0	759905	Zippered Case/Boxed

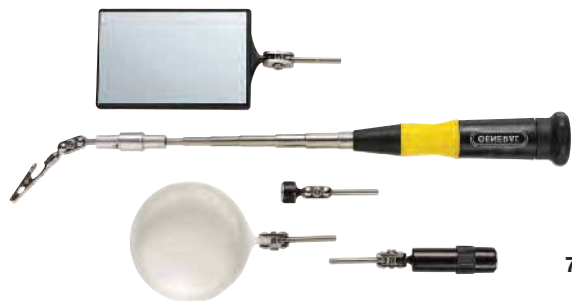

759905

**9-PIECE TELESCOPING "SPEED-CHUCK"™ INSPECTION SET**

- Set includes: • 26" stainless steel telescoping wand with *Speed-Chuck*™ assembly • 2 lb., 5 lb. and 10 lb. magnetic pick-ups • 1-1/2" round mirror • 2" x 3" rectangular mirror • 2-1/2" round glass magnifying mirror • 3x power magnifier, alligator clip • Mini-Lite • Batteries included
- Precision engineered 750 Series Versa-Grip™ handle for maximum performance

UPC	NO.	PKG.
75962 7	759909	Zippered Case/Boxed



759909

**TELESCOPING MAGNETIC PICK-UPS**

- High powered 2 lb., 5 lb., 10 lb. Neodymium magnets are 6 times stronger than standard Cobalt magnets
- Double ball joint connection permits infinite angle adjustments
- High strength corrosion resistant stainless steel wand extends from 6-1/2" - 27" (165mm - 686mm)
- Magnet holder is constructed of high-strength reinforced nylon
- Precision engineered 750 Series Versa-Grip™ handle for maximum performance

UPC	NO.	PULL	PKG.
75933 7	759383	2 lb.	Carded
75958 0	759394	5 lb.	Carded
75939 9	759398	10 lb.	Carded



759383  
759394  
759398

SPECIALTY



### FIXED LENGTH MAGNETIC PICK-UP, 2 LB. PULL

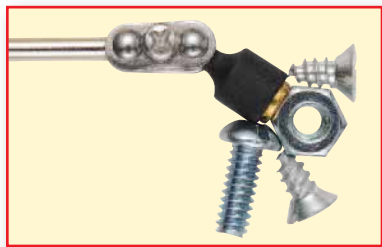

709392

- Has a 2 lb. smooth surface magnetic pull capacity with an overall length of 6-3/4" (171mm)
- High strength stainless steel shaft resists corrosion
- Durable ball joint connection permits infinite angle adjustments
- High powered Neodymium Magnet is 6 times stronger than standard Cobalt Magnets

- Magnet holder is made of high-strength reinforced nylon
- Precision engineered 700 Series Versa-Grip™ handle for maximum performance

UPC	NO.	PKG.
70972 1	709392	Carded

### POCKET MAGNETIC PICKUP

- Powerful permanent magnet in a knurled aluminum holder with handy pocket clip
- High-powered neodymium magnet is six times more powerful than standard magnet
- Ideal for retrieving small steel and iron parts from hard-to-reach areas

- Measures 5-1/2" (140mm) overall

UPC	NO.	MAGNET	PULL
42219 4	386	NEO	2 lb. pull

386

### FLEX-O-STIFF MAGNETIC PICKUP

- An ideal tool for retrieving steel parts from hard-to-reach places
- High-powered neodymium magnet is six times more powerful than standard magnet
- Permanent magnetic power

- Magnet is fitted into an 18" (457mm) nickel plated holder, which can be extended to a 32" (813mm) flexible retriever

UPC	NO.	MAGNET	PULL
42210 1	384N	NEO	2 lb. pull

384N

### MAGNETIC PICKUP WITH PIVOT JOINT

- An excellent tool for retrieving small steel parts from hard-to-reach places
- High-power neodymium magnet lifts up to two pounds and will never lose its magnetism
- 8-3/4" (222mm) overall length

- Locking pivot joint allows user to pick up objects around corners
- Nickel plated steel body with cushion grip handle
- Pocket clip for convenient storage

UPC	NO.	PULL
42224 8	392	2 lb. pull

392

### EXTRA-LONG, MAGNETIC PICKUP WITH PIVOT JOINT

- An excellent tool for retrieving steel parts from hard-to-reach places
- High-power neodymium magnet lifts up to five pounds and will never lose its magnetism
- Steel body measures 13" (330mm) and can be extended to 27" (685mm)

- Locking pivot joint allows user to pick up objects around corners
- Body is chrome plated, with a vinyl cushion grip handle

UPC	NO.	PULL
42228 6	394	5 lb. pull

394



# Magnetic Retrieving Tools



## BENDABLE MAGNETIC PICK-UP

- An excellent tool for retrieving steel parts from hard-to-reach places
- High-power neodymium magnet
- Knurled aluminum body with bendable 15" (381mm) wire

- Overall length is 20" (508mm)
  - Lifts up to 2 pounds
- | UPC     | NO. | PULL       |
|---------|-----|------------|
| 42229 3 | 395 | 2 lb. pull |

**395**

## TELESCOPING MAGNETIC PICKUP

- A powerful permanent magnetic pickup tool
- Ideal for retrieving steel and iron parts from hard-to-reach work areas
- Magnet is fitted in a 5-1/2" long nickel plated steel handle that can extend up to 23-1/2"

- Holder is fitted with a pocket-clip
- | UPC     | NO.   | PULL       |
|---------|-------|------------|
| 42208 8 | 383NX | 2 lb. pull |

**383NX**

## TELESCOPING MINI-LIGHT WITH MAGNETIC PICK-UP

- Mini Light with 2 lb. Neodymium Magnetic pick-up are both fastened to a stainless steel telescoping wand molded into a rugged high-impact ABS plastic handle
- Telescopes from 7-3/4" – 28-3/4" (197mm – 720mm)
- 4 Alkaline, "LR41", batteries with a battery life of 48 continuous hours
- LED bulb has a life of 100,000 hours of continuous use

- Has a 2 lb. smooth surface pull capacity Neodymium donut magnet
- Precision engineered 750 Series Versa-Grip™ handle for maximum performance

UPC	NO.	PKG.
75966 5	759581	Carded
75967 2	759582	Carded

**759582**

## TELESCOPING MINI-LITE WITH MAGNETIC PICK-UP

- A powerful permanent magnetic pick-up tool
- Ideal for retrieving steel and iron parts from hard-to-reach and see work areas
- Magnet is fitted in a 5-1/2" (140mm) long ergonomically designed handle
- 4 Alkaline, "LR41", batteries with a battery life of 48 continuous hours
- Light Bulb has a life of 100,000 hours of continuous use

- Mini-Light is fastened to a chrome plated brass wand with a double ball joint
- Ball and socket feature for simple, positive adjustments

UPC	NO.	PKG.
05820 1	582	Carded

**582**

## PRECISION MAGNETIZER/DEMAGNETIZER

- Magnetize and demagnetize screwdrivers, tweezers, tool bits and other steel objects
- Magnetize by sliding the tool through the (+) opening
- Demagnetize by sliding the tool through the (-) opening

- Demagnetize tools for use in electronics
- Step design permits greater control of magnetism

UPC	NO.	DIMENSIONS
36010 6	3601	2" x 2" x 1-1/8" (58 x 58 x 29mm)

**3601**

## MAGNETIZER/DEMAGNETIZER

- Specially designed for magnetizing and demagnetizing screwdrivers, nut drivers, wrenches, taps and small tools
- Converts any tool blade into a magnetic retriever for screws, nuts and metallic particles

UPC	NO.	DIMENSIONS
42021 3	360	1" x 1" x 1-3/4" (25 x 25 x 44mm)

**360**



## SPECIALTY TOOLS

# Magnetic Retrieving Tools



The Magnetic Sweeper is an ideal tool for retrieving iron, steel and all ferrous materials. Especially effective around new construction sites, both indoors and outdoors. Also effective in machine

shops for cleaning up around power equipment such as drill presses, milling machines and lathes. The Magnetic Tool Rack holds and organizes tools in garages, work shops and service stations.



397

### PICKUP STICK™ SWEEPER

- An ideal tool for retrieving iron, steel and all ferrous materials
- Powerful, permanent magnet for a no-stoop pick-up
- Vinyl-coated magnet for long-life and durability

- 37" (940mm) steel shaft for greater strength and durability
- Plastic handle grip for greater control and comfort

UPC	NO.
31434 5	397 Pickup Stick



354

### UTILITY SWEEPER

- An ideal tool for retrieving iron, steel and all ferrous materials
- Powerful, permanent magnets for a no-stoop pick-up
- 39" (991mm) aluminum shaft
- Plastic handle grip for greater control and comfort

- Some assembly required

UPC	NO.	WIDTH
22189 6	354 Sweeper	24" (610mm)

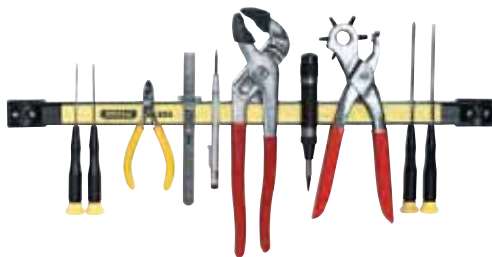

250



### MAGNETIC TOOL RACK

- Holds and organizes tools in garages, workshops and service stations
- Powerful permanent magnet
- Includes: 1 - 20" Magnetic Tool Rack, 2 mounting brackets with screws

- Modular mounting brackets can be used to create additional lengths

UPC	NO.	WIDTH
25001 8	250	20" (508mm)

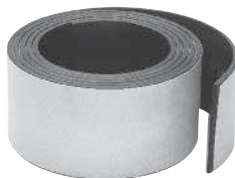

368

### MAGNETIC STRIPS

- Our flexible magnetic strip with adhesive backing adheres to most smooth clean surfaces
- Holds small-metal objects
- 1/16" thick and easily cuts to desired length with scissors or knife

UPC	NO.	SIZE
42027 5	366	1/2" x 30"
42033 6	368	1" x 30"
42036 7	369	1" x 10"
42038 1	369-100	1" x 100"



376

### SHALLOW POT CERAMIC MAGNETS

- Shallow depth permits use in confined spaces
- Nos. 376A and 376B have 3/16" diameter clearance holes for fastening with rods or bolts
- No. 376C has a 9/32" diameter clearance hole

UPC	NO.	DIA.	DEPTH	PULL
42111 1	376A	1-3/8"	3/16"	12 lbs.
42114 2	376B	2"	1/4"	20 lbs.
42117 3	376C	2-5/8"	3/8"	35 lbs.





Aluminum, nickle and cobalt alloy make General's Alnico line of magnets strong and permanent. The strong magnetic pull of the Alnico Magnets make it perfect for lifting, holding, sorting, clamping or

retrieving steel or iron parts. Alnico Magnets will retain their magnetic force indefinitely. Removable keepers insure long life and optimum performance.

### BUTTON TYPE ALNICO MAGNETS

- Button shaped magnet has almost unlimited applications
- Retrieves screws and steel parts
- Center hole on top of magnet for easy fastening

UPC	NO.	DIA.	HT.	PULL	CORED HOLE
42073 2	<b>372A</b>	1/2"	3/8"	1-1/2 lbs.	1/8"
42076 3	<b>372B</b>	3/4"	1/2"	4 lbs.	1/8"
42079 4	<b>372C</b>	1"	5/8"	6-1/2 lbs.	3/16"
42082 4	<b>372D</b>	1-1/4"	3/4"	14 lbs.	3/16"
42085 5	<b>372E</b>	1-1/2"	7/8"	18-1/2 lbs.	1/4"

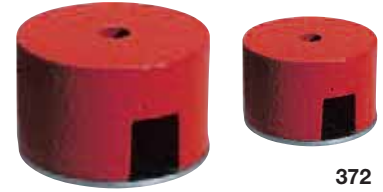

372

### POT TYPE ALNICO MAGNETS

- Unique combination of strong magnet with insulating ring gives this magnet the superior holding power of larger magnets
- 1/4" diameter x 20 threads-per-inch hole for attaching to fixtures and machines

UPC	NO.	DIA.	PULL	WT.	HT.
42093 0	<b>374A</b>	11/16"	6 lbs.	6 oz.	5/8"
42096 1	<b>374B</b>	13/16"	10 lbs.	6 oz.	3/4"
42102 9	<b>374C</b>	1-1/16"	18 lbs.	12 oz.	1"
42105 0	<b>374D</b>	1-3/8"	35 lbs.	24 oz.	1-3/16"



374

### POWER ALNICO MAGNETS

- Strong magnetic pull for lifting, holding, sorting, clamping or retrieving steel or iron parts
- Hole in top of magnet for attaching conveyors, racks, and welding jigs

UPC	NO.	SIZE OZ.	APPROX. PULL LBS.	WIDTH IN.	HT. IN.	DEPTH IN.	POLE WIDTH IN.	OPENING BETWEEN POLES, IN.	CORED HOLE	OZ. WEIGHT EACH WITH KEEPER
42041 1	<b>370-1</b>	.8	8	1-1/8"	1"	5/16"	5/16"	1/4"	—	1
42044 2	<b>370-2</b>	2	13	1-1/8"	3/4"	3/4"	1/4"	9/16"	3/16"	3
42050 3	<b>370-4</b>	4	22	1-1/2"	1"	1"	5/16"	3/4"	3/16"	5
42053 4	<b>370-6</b>	6	30	1-3/4"	1-1/8"	1-1/8"	5/16"	7/8"	3/16"	8
42056 5	<b>370-8</b>	8	32	2-3/16"	1-13/16"	15/16"	1/2"	1-3/16"	3/16"	10
42061 9	<b>370-12</b>	12	42	2-5/8"	2-1/4"	15/16"	5/8"	1-3/8"	3/16"	15
42064 0	<b>370-16</b>	16	50	3"	2-1/2"	15/16"	3/4"	1-1/2"	3/16"	20
42067 1	<b>370-24</b>	24	70	2-1/2"	1-13/16"	1-7/8"	5/8"	1-3/8"	1/4"	28

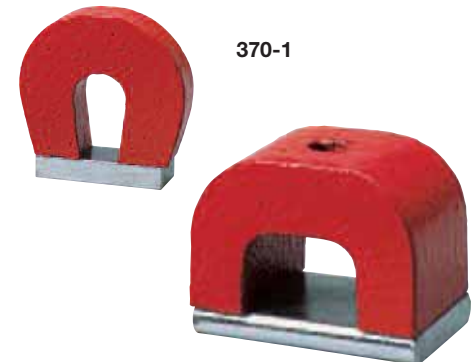

370-1

370-2

### WELDING MAGNET

- Designed to enable fast and accurate holding of ferrous metal for welding and assembly jobs
- Holds both sheet and tube at angles of 180°, 90°, 45° and 30°
- Two body holes enable the clamp to be built into jigs or hung when not used

- Small compact design makes the "quick clamp" useful for all light ferrous fabrication work
- Ideal to include in the tool kit for numerous holding applications

UPC	NO.	THICKNESS	PULL LBS.	WT. OZ.
42122 7	<b>377</b>	.468	50.0	9.0

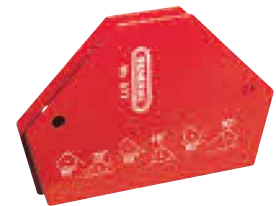

377

### MAGNETIC ADJUSTABLE WELDING LINK

- Ideal for holding steel plates in position for welding, brazing, and soldering, eliminating the need for clamps or temporary fastening
- General's welding links are constructed of two heavy-duty Alnico magnetic blocks

linked together with a strong steel bar and wing nuts for easy angle adjustment

UPC	NO.	SIZE OF BLOCK	PULL PER BLOCK
42226 2	<b>375</b>	2.4" x 1" x 1"	25 lbs.

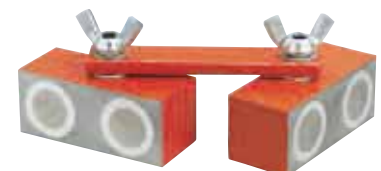

375

**GENERAL<sup>®</sup>**

# THE QUAD<sup>™</sup>

## SAW/DRIVER

### A 4-IN-1 CUTTING & DRIVING SYSTEM

QP05



**1. JAB SAW**



**2. KEYHOLE SAW**



**3. POWER DRIVER**



**4. SPEED DRIVER**



**The Keyless Quick Change Locking Chuck accepts both Quick Change Power Bits and Standard Reciprocating Saw Blades.**





# The "QUAD" Saw/Driver

"THE QUAD™" Saw/Driver set offers a 4-IN-1 Cutting and Driving System; a jab saw, key hole saw, power driver, and speed driver.

The 2 position quick change locking handle offers both power and speed. A convenient holster holds all 14 pieces.



## THE QUAD SAW/DRIVER

### "THE QUAD™" 14 PIECE SAW/DRIVER SET

- A 4-IN-1 cutting and driving system
  - ① Jab Saw with straight handle and special Sheetrock reciprocal blade
  - ② Keyhole Saw in the pistol grip handle position
  - ③ Power Driver in the pistol grip position
  - ④ Speed Driver, screw or nut driver with straight handle
- The keyless Quick-Change locking chuck accepts both Quick-Change bits and industry standard reciprocating saw blades

### 14 PIECE SET INCLUDES:

- 3 saw blades; drywall, Metal/PVC, wood,
- 7 insert bits
- 1 hex to square adaptor
- 1 quick change handle
- 1 holster with belt-clip
- 1 bit extender
- Swivel locking chuck holds all reciprocating blades and speed shank power bits
- Comfortable handle easily locks in the straight or pistol grip position

UPC	NO.
86014 9	86014



Bit Extender



GENERAL METAL/PVC 6" X 24 TPI



GENERAL WOOD 6" X 10 TPI



86014

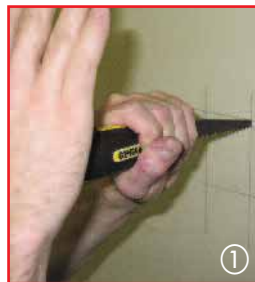

①



②



③



④



HOLSTER

SPECIALTY



General Tools Professional Quality Knife Sets are designed specifically for the precision cutting of a variety of materials, from fine, intricate cutting to heavy-duty carving and scraping.

General Tools offers a complete line of precision hobby knives for industrial users, crafts people and hobbyists. A broad selection of surgically sharp replacements and accessory blades are available.



1901



1902



1903

### PRECISION HOBBY KNIVES

- Precision knives for fine angle cuts

UPC	NO.	HANDLE CONSTRUCTION	KNIFE WEIGHT	PKG. QTY.
43974 1	1901	Aluminum	Light duty	5
43976 5	1902	Aluminum	Medium duty	5
43978 9	1903	Aluminum	Heavy-duty	5

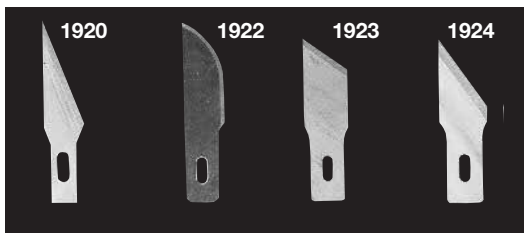

### HOBBY KNIFE BLADES

- For precision cutting from medium to heavy cuts
- Packed in a quantity of 5.

UPC	NO.	REPLACEMENT FOR
43988 8	1920	1901
43992 5	1922	1902, 1903, 1905
43994 9	1923	1902, 1903, 1905
43996 3	1924	1902, 1903, 1905



1915

### PRECISION KNIFE SET

- Consists of one each of Nos. 1901, 1902 and 1903 knives and 10 assorted blades in a fitted wooden case

UPC	NO.
43984 0	1915

### 22-PIECE PRECISION KNIFE AND BLADE SET

- Designed specifically for the precision cutting of a variety of materials
- Heavy-duty locking screw chuck holds blades securely in place
- Set includes:
  - 2 Multi-Blade Handles No. 1 and No. 2
  - 20 Knife Blades -
    - 5 - No. 11
    - 5 - No. 16
    - 3 - No. 17B
    - 3 - No. 22
    - 2 - No. 26
    - 2 - No. 28 blades
- Packaged in a pocket sized zippered case
- All ULTRATECH™ knife handles accept industry standard blades
- Precision engineered 700 and 750 Series Versa-Grip™ handle for maximum performance

UPC	NO.	PKG.
75622 0	75622	Zippered Case/Carded



75622



#26 #16 #28 #17 #11 #22  
Blades shown actual size



SPECIALTY

# Cutting & Carving Tools

General's Utility Knives are used for cutting and scoring fiber-board, matboard, roofing, linoleum, carpeting, plasterboard and veneers.

The Five-Piece Carving Tool Set offers a fixed blade that is forged tool steel, ground and hardened for lasting sharpness. Handles are made of hardwood for greater control and comfort grip.

### SLIDE LOCKING UTILITY KNIFE

- For cutting and scoring fiberboard, wall-board, matboard, cardboard, corkingboard, roofing, linoleum, carpet, plasterboard, veneers and other materials
- Opens instantly to any one of three cutting positions
- Blade retracts into handle for safety

- Comes with three replaceable heavy-duty alloy steel blades, No. 852, in storage handle

UPC	NO.
43046 5	855 Heavy-duty



855

### HEAVY-DUTY UTILITY KNIFE BLADES

UPC	NO.	THICKNESS	PKG. QTY
43027 4	852-5	0.025	5
43030 4	852-100	0.025	100



852

### FIVE-PIECE CARVING TOOL SET

- Five different blade shapes
- Blades are made of hand forged tool steel, ground and hardened for lasting sharpness
- Half round palm style handles are made of hardwood
- Comes in vinyl case
- Overall length 5"

UPC	NO.	BLADE SHAPE
43900 0	1293	Bent large gouge, 5/16" Straight small gouge, 5/32" Bent V parting tool, 5/32" Straight skew chisel, 5/16" Bent square chisel, 5/16"

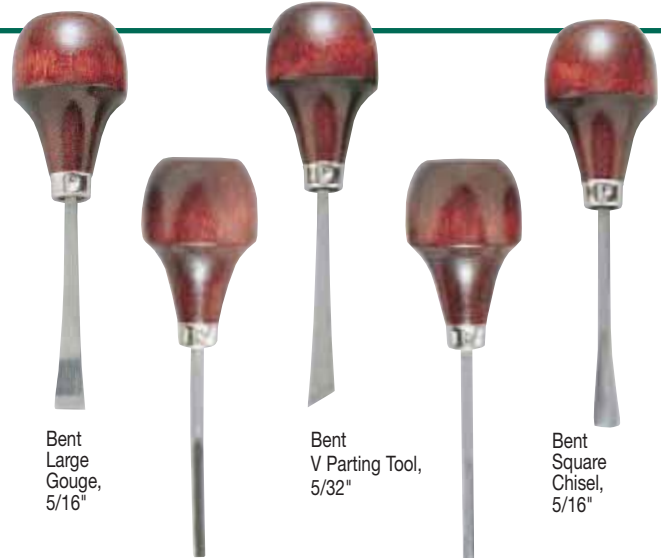

Bent Large Gouge, 5/16"

Bent V Parting Tool, 5/32"

Bent Square Chisel, 5/16"

Straight Small Gouge, 5/32"

Straight Skew Chisel, 5/16"

1293

### GLASS CUTTER

- Cuts plate glass from 1/8" to 1/4" thick
- Steel wheel with honed angle of 120° for cutting single and double strength glass
- Ball end handle for snapping of scored glass
- Tooth design to remove rough edges

UPC	NO.	LENGTH
43061 8	8501	5" (125mm)



8501

### JUNIOR HACKSAW

- Handy cutting tool for hobbyists, do-it-yourselfers and professionals
- Ergonomically designed with a comfortable high-impact plastic handle
- 6" (150 mm) replaceable heat treated blade for cutting metal
- Sturdy tubular frame

- Reversible blade for push or pull cutting
- Set of 6 replacement blades: 3 wood and 3 metal

UPC	NO.
43067 0	864
43070 0	864B Set of 6 Blades



864



General Tools offers Solid Brass Grommet Kits, which are available in three sizes, Snap Fastener Kits and Screw Fastener Kits. These various kits are

used to repair canvas, tarpaulins, tents, awnings, sailcloth, lawn furniture and pool covers. Each set has handy step-by-step instructions.



**UTILITY GROMMET KITS**

- These various size kits are used to repair canvas, tarpaulins, tents, awnings, sailcloth, lawn furniture and pool covers
- Contains brass plated steel grommets with hole cutter and hardwood backer block, hardened mandrel and anvil
- Setting tool has knurled body for greater comfort and safety
- Setting tool and anvil are coded with lines for each individual size grommet
- Three sizes available



**INDIVIDUAL SIZE**

UPC	NO.	DESCRIPTION
22341 8	<b>71260</b>	1/4" Grommet Kit with 48 grommets
22342 5	<b>71262</b>	3/8" Grommet Kit with 24 grommets
22343 2	<b>71264</b>	1/2" Grommet Kit with 12 grommets

**GROMMET REFILLS**

UPC	NO.	SPECIFICATIONS
41103 7	<b>1261-0</b>	1/4" Grommet Refill with 24 Grommets
41104 4	<b>1261-2</b>	3/8" Grommet Refill with 24 Grommets
41105 1	<b>1261-4</b>	1/2" Grommet Refill with 24 Grommets



**SNAP FASTENER KIT**

- Contains 2-piece setting tool and 6 fastener sets
- Solid brass fasteners with nickel plating will not rust
- Knurled body for greater comfort and safety

UPC	NO.	SPECIFICATIONS
41106 8	<b>1265</b>	Snap Fastener Kit with 6 Fasteners
41107 5	<b>1266</b>	6 Snap Fastener Refills



**SCREW SNAP FASTENER KIT**

- Contains 2-piece setting tool and 6 fastener sets
- Solid brass fasteners with nickel plating will not rust
- Knurled body for greater comfort and safety
- Screw snap fastener base has 3/8" long screw for attaching to wood, plastic and fiberglass

UPC	NO.	SPECIFICATIONS
41108 2	<b>1267</b>	Screw Snap Fastener Kit with 6 Fasteners
41109 9	<b>1268</b>	6 Screw Snap Fastener Refills



SPECIALTY

# Punches & Punch Sets

Arch Punches, Hollow Steel Punches and Gasket Punches are all used for punching round holes in gasket material, leather, rubber, canvas, cardboard, plastic, sheet metal and other soft materials.

These fine quality tools are forged and heat-treated for long life and the cutting edges will stay sharper longer.

## ARCH PUNCHES

- For punching holes in leather, rubber, gasket material and soft metals
- Inside taper for clearance
- Heat treated forged steel
- The 1271ST consists of seven punches, one each of 1/4", 3/8", 1/2", 5/8", 3/4", 7/8" and 1", comes in plastic roll pouch

UPC	NO.	SIZE
43849 2	1271ST	Set of 7

- Available in individual sizes listed

UPC	NO.	SIZE
43793 8	1271A	1/4"
43799 0	1271C	3/8"
43804 1	1271E	1/2"
43810 2	1271G	5/8"
43813 3	1271H	11/16"
43816 4	1271-I	3/4"
43819 5	1271J	13/16"
43821 8	1271K	7/8"
43822 5	1271L	15/16"
43825 6	1271M	1"
43827 0	1271N	1-1/8"
43829 4	1271-O	1-1/4"
43831 7	1271P	1-3/8"
43833 1	1271Q	1-1/2"



## HOLLOW STEEL PUNCHES

- For punching holes in leather, rubber, canvas, cardboard, plastic and other materials
- Made of forged steel with side clearance hole for easy removal of punched material
- The 1280ST which consists of six punches, 3/16", 1/4", 5/16", 3/8", 7/16", and 1/2", comes in a plastic roll pouch

UPC	NO.	SIZE
43896 6	1280ST	Set of 6

- Available in individual sizes listed

UPC	NO.	SIZE
43856 0	1280A	3/32"
43859 1	1280B	1/8"
43862 1	1280C	5/32"
43865 2	1280D	3/16"
43868 3	1280E	7/32"
43870 6	1280F	1/4"
43872 0	1280G	9/32"
43874 4	1280H	5/16"
43876 8	1280-I	11/32"
43878 2	1280J	3/8"
43880 5	1280K	13/32"
43882 9	1280L	7/16"
43884 3	1280M	1/2"
43886 7	1280N	9/16"
43888 1	1280-O	5/8"
43890 4	1280P	3/4"



1280ST

## PROFESSIONAL 10-PIECE GASKET PUNCH SET

- For punching holes in gasket material, leather, rubber, canvas, cardboard, plastic and sheet metal
- Nine interchangeable hardened and tempered alloy steel punches: 1/4", 5/16", 3/8", 7/16", 1/2", 5/8", 3/4", 7/8" and 1"
- Heavy-duty, spring-loaded, self-centering steel mandrel
- Both mandrel and punches are knurled and have a threaded coupling to prevent slippage and hold punch securely to mandrel

- Fitted plastic storage case

UPC	NO.	DESCRIPTION
43751 8	S1274	10 pc. set



S1274

## GASKET PUNCH SET

- Compact and economical set for punching holes in soft materials and leather
- Set of 10 punches, one each of 1/4", 5/16", 3/8", 7/16", 1/2", 9/16", 5/8", 3/4", 7/8" and 1", with driving mandrel comes in a molded plastic storage case

UPC	NO.
43759 4	S1270



S1270



# SPECIALTY TOOLS

## Pliers

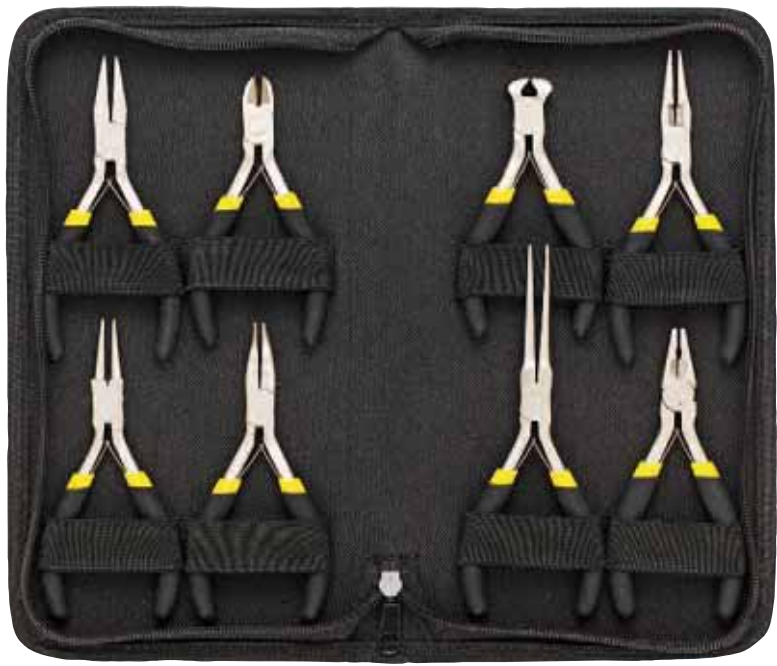
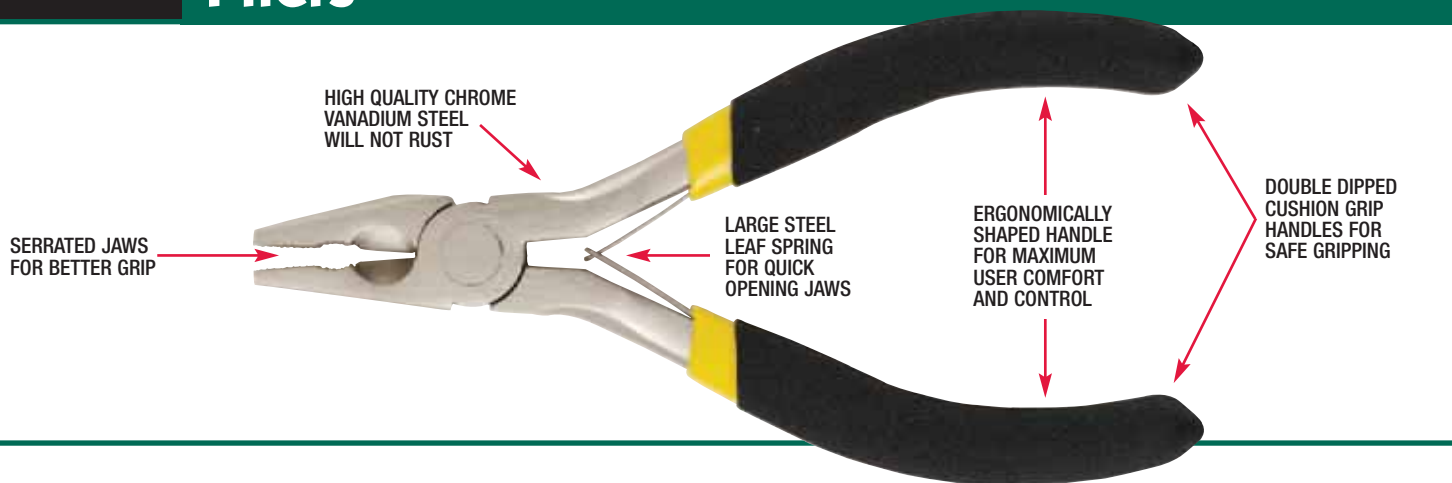

### 8-PIECE TECHNICIAN'S MINI-PLIER SET

- A compact set designed for Electricians, Technicians, Hobbyists and Do-it-Yourselfers
- High quality Chrome Vanadium Steel will not rust
- Serrated jaws for better grip
- Large Steel Leaf Spring for quick opening jaws
- Fully-polished head
- Double dipped cushion grip handles for safe gripping
- Durable Vinyl Case for the easy and safe storage of these precision pliers
- Consists of eight of the most popular sizes of mini-pliers
  - No. 901 - Chain Nose Serrated Jaw Pliers. OAL - 5"
  - No. 902 - Round Nose Pliers. OAL - 4-3/4"
  - No. 903 - Smooth Jaw Pliers. OAL - 4-7/8"
  - No. 904 - Curved Chain Nose Pliers. OAL - 4-3/4"
  - No. 905 - Long Needle Nose Pliers. OAL - 6"
  - No. 906 - Diagonal Head/Oval Cutter. OAL - 4-1/4"
  - No. 907 - End Cutter. OAL - 4-1/8"
  - No. 908 - "Mini" Linemans Pliers. OAL - 4-1/2"
- No. 938 - 8 piece "Mini" Plier Set
- No. 934 - 4 piece "Mini" Plier Set; Nos. 905, 906, 907, 908

UPC	NO.	PKG.
00938 8	938	8 Piece - Vinyl Case/Boxed
00934 0	934	4 Piece - Vinyl Case/Boxed

### CHAIN NOSE, SERRATED JAW PLIERS

- For cutting, shaping, bending and gripping light materials and wire
- Side cutter will handle most cutting requirements
- OAL jaw length - 1-3/16" (30mm)
- OAL length - 5" (127mm)

UPC	NO.	PKG.
41059 7	901	Bulk (Open Stock)

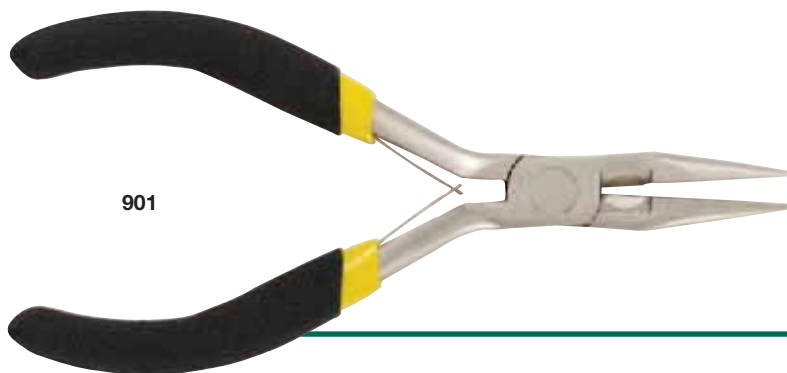

901

### ROUND NOSE PLIERS

- The perfect jewelers pliers for making loops and jump rings
- OAL jaw length - 1-1/16" (27mm)
- OAL length - 4-3/4" (120mm)

UPC	NO.	PKG.
41061 0	902	Bulk (Open Stock)

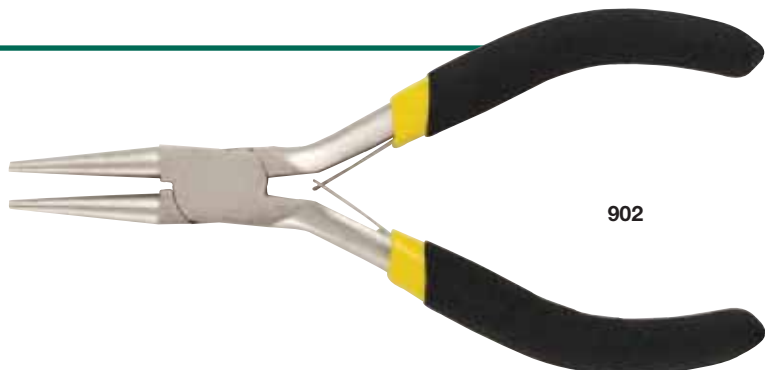

902

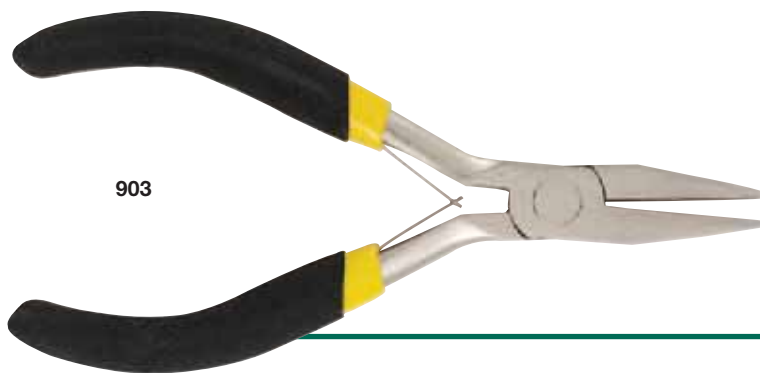

903

**FLAT NOSE, SMOOTH JAW PLIERS**

- For bending wire, jewelry making and retrieving objects from tight areas
- OAL jaw length - 1-1/16" (27mm)
- OAL length - 4-7/8" (124mm)

UPC	NO.	PKG.
41064 1	903	Bulk (Open Stock)

**CURVED CHAIN NOSE PLIERS**

- Used for odd angle access, retrieving and positioning with non-serrated jaws
- OAL jaw length - 1-1/8" (29mm)
- OAL length - 4-3/4" (120mm)

UPC	NO.	PKG.
41066 5	904	Bulk (Open Stock)

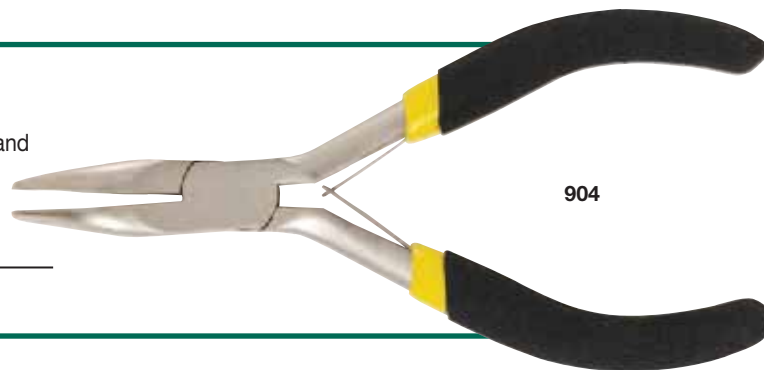

904

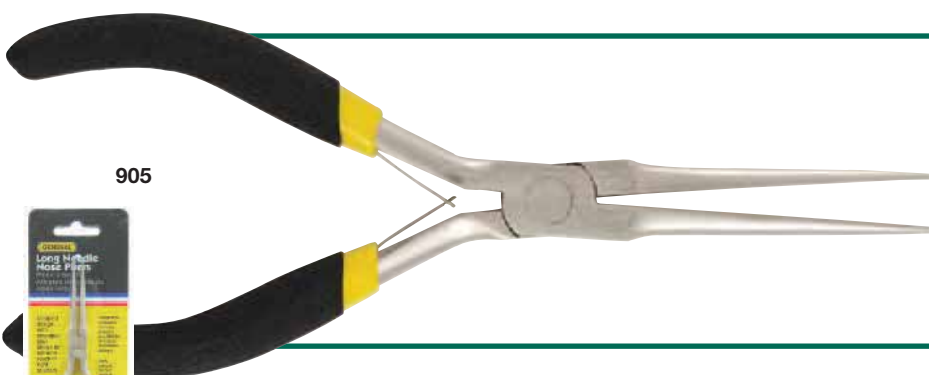

905

**LONG NEEDLE NOSE PLIERS**

- Used for extreme far reaching access, positioning and retrieving
- OAL jaw length - 2-1/8" (54mm)
- OAL length - 6" (152mm)

UPC	NO.	PKG.
41067 2	905	Bulk (Open Stock)

**OVAL HEAD DIAGONAL CUTTER**

- For cutting soft wire and other light materials. For an accurate cut in tight areas
- OAL jaw length - 1/2" (13mm)
- OAL length - 4-1/4" (108mm)

UPC	NO.	PKG.
41069 2	906	Bulk (Open Stock)

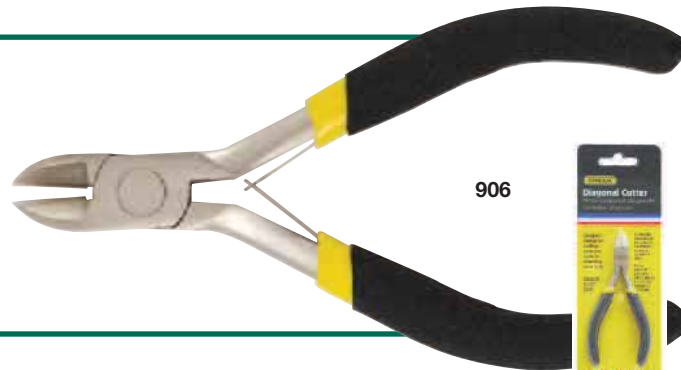

906

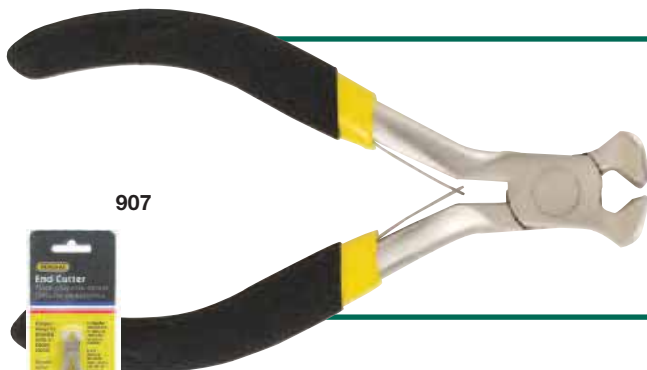

907

**END CUTTER**

- For accurate flush surface cutting of light materials and wire
- OAL jaw length - 9/32" (7mm)
- OAL length - 4-1/8" (105mm)

UPC	NO.	PKG.
00907 4	907	Bulk (Open Stock)

**"MINI" LINEMAN'S PLIERS**

- For securing a positive grip on flat objects to form a bend
- Serrated jaws for better grip
- Side cutter will handle most cutting requirements
- OAL jaw length - 7/8" (22mm)
- OAL length - 4-1/2" (114mm)

UPC	NO.	PKG.
00908 1	908	Bulk (Open Stock)

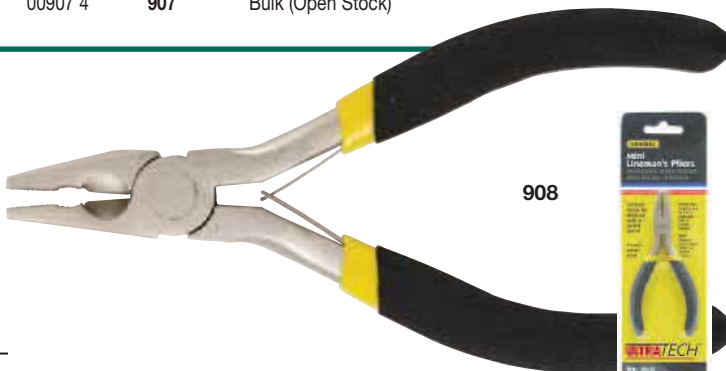

908

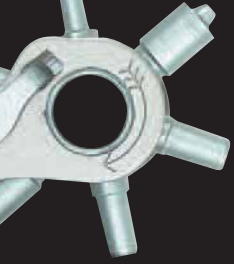

# SPECIALTY TOOLS

## Punches, Scrapers & Files



General's Revolving Punch Plier is a convenient spring tension, self-opening tool for punching round holes in leather, plastic, rubber, canvas cardboard and similar materials.

The Dial Wire Stripper can be set to a desired size for individual or repetitive stripping without damaging the wire.



### REVOLVING PUNCH PLIER

- A convenient spring tension, self-opening tool for punching round holes in leather, plastic, rubber, canvas, cardboard and similar materials
- Made of plated steel with six tapered and hollow, hardened steel punches
- Punch sizes: 5/64", 3/32", 7/64", 1/8", 5/32", 3/16" (2.0, 2.5, 3.0, 3.5, 4.0, 4.5mm)

UPC	NO.	LENGTH
41039 9	72	8-1/4" (210mm)

72



### DIAL WIRE STRIPPER

- Dial the wire size desired for individual or repetitive stripping without damaging wire
- Spring opening for fast and easy cutting or stripping

- Dial lock closes stripper to protect hardened cutting edges
- Vinyl cushion handles

UPC	NO.	WIRE GAGE CAPACITY
41036 8	69	12, 14, 16, 18, 20, 22, 24, 26

69



### COTTER PIN PULLER

- General's compound bend design allows user to extract cotter pins with either a pull or twist motion. Ideal for use in confined work areas
- Plated shaft and point are 4" (101mm) in length and made of long lasting heat treated high carbon steel

- A safe and easy way to remove cotter pins
- Heavy-duty plastic handle with a comfortable grip

UPC	NO.	SPECIFICATIONS
41030 6	64	Length: 7-1/2" (190mm)

64



The compound bend design allows extraction with either a pull or twist motion.



### TRIANGULAR SCRAPER

- Useful tool for scraping, trimming, and deburring metals, tubing and other materials
- Hardened and tempered triple edge blade is secured in wood handle with steel ferrule

- Hollow ground cutting edges stay sharp longer and sharpen easily

UPC	NO.
42321 4	478

478



### SIX-PIECE SWISS PATTERN NEEDLE FILE SET

- Designed to meet the exacting requirements of tool and die makers, instrument makers, jewelers, watchmakers and other craftspeople
- Precision made of finest quality tool steel

- Packed in snap button plastic case
- #2 single style cut

UPC	NO.	LENGTH	FILES IN SET
42318 4	S476	5-1/2"	6

S476

#### FILE END VIEWS

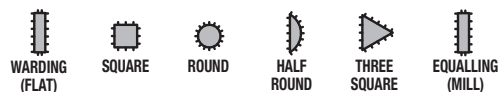





# Multi-File & Needle File Sets

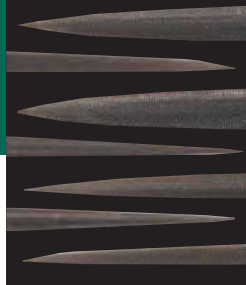

General Tool's Swiss Pattern Needle File Sets are designed to meet the exacting requirements of tool and die makers, instrument makers, jewelers, watchmakers, hobbyists and other craftspeople.

Precision made of the finest quality tool steel. The 5-1/2" long knurled aluminum handle provides maximum filing control and comfort and will fit all styles of General's Swiss Pattern Files.

### FOUR-PIECE SWISS PATTERN NEEDLE FILE SET WITH HANDLE

- Set includes three of the most commonly used file shapes: flat, round and triangular. All are high-quality tool steel and measure 5-1/2" (138mm) long
- A 5-1/2" (138mm) long knurled aluminum handle provides maximum filing control and comfort

- 8-1/2" (213mm) overall size
- #2 single style cut
- General Purpose file set for hobbyists and craftsmen

UPC	NO.
42315 1	S477 3 files and handle



### SWISS PATTERN NEEDLE FILE SET

- A complete set of General Purpose files to meet the needs of craftsman, hobbyists and jewelers
- Files are made of high quality tool steel
- Set includes 12 different files including the three most commonly used file shapes: flat, round and triangular. All measure 5-1/2" (138mm) long

- Packed in snap button plastic case
- #2 single style cut

UPC	NO.	LENGTH	FILES IN SET
42315 3	S475	5-1/2"	12

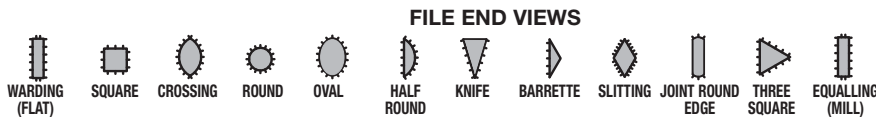

### 6-PIECE SWISS PATTERN NEEDLE FILE SET

- A basic set of General Purpose Files to meet the needs of craftspeople, tool and die makers, hobbyists and jewelers
- Set includes 6 different files. All measure 5-1/2" (138mm) long with 1/8" (3mm) diameter shanks
- Files are constructed of high quality Chromium Alloy Steel
- All files are 2-1/2" (63mm) long, #2 Single Cut Swiss Pattern
- Knurled handle file can be used without handle assembly
- Precision locking screw chuck holds files securely in place
- Precision engineered 700 Series Versa-Grip™ handle for maximum performance

UPC	NO.	PKG.
70746 8	707476	Holster/Carded

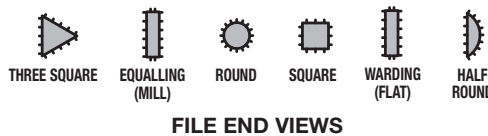

707476

### ADJUSTABLE FILE/TOOL HANDLE

- For holding files, reamers, hacksaw blades and other tang handled tools
- Exclusive steel parallel clamping jaws grip the entire length of the inserted tang to prevent slipping
- Large, quick adjusting knurled knob ensures positive locking
- Rustproof handle with steel parts

- Conforms to government specifications NN-H-0085

UPC	NO.
43666 5	890



890

# SPECIALTY TOOLS

## File & Probe Sets



General Tool's Swiss Pattern Needle File Sets are designed to meet the exacting requirements of tool and die makers, instrument makers, jewelers, watchmakers, hobbyists and other craftspeople. Precision made of the finest quality tool steel. Knurled handle file can be used

without handle assembly. Precision locking screw chuck holds files securely in place. General's Probe, Positioning and Spring Hooks are useful in a wide variety of mechanical and electrical functions. Ideal for probing, cleaning, picking or marking small work surfaces.



707475

### 12-PIECE SWISS PATTERN NEEDLE FILE SET

- A complete set of General Purpose Files to meet the needs of craftspeople, tool and die makers, hobbyists and jewelers
- Set includes 12 different files. All measure 5-1/2" (138mm) long with 1/8" (3mm) diameter shanks
- Files are constructed of high quality Chromium Alloy Steel
- All files are 2-1/2" (63mm) long, #2 Single Cut Swiss Pattern
- Knurled handle file can be used without handle assembly
- Precision locking screw chuck holds files securely in place
- Precision engineered 700 Series Versa-Grip™ handle for maximum performance

UPC	NO.	PKG.
70745 1	707475	Zippered Case/ Carded



### FILE END VIEWS



707862



### 4-PIECE INTERCHANGEABLE STAINLESS STEEL PROBE SET

- For probing, cleaning, picking, or marking small work surfaces
- Set Includes: • 4 heat treated stainless steel point configurations: • Straight • 180° Hook • 35° Bend • 90° Bend
- Precision locking screw chuck holds blades securely in place
- Each blade is 5" long (127mm); OAL 8-1/2" (216mm) with handle
- Precision engineered 700 Series Versa-Grip™ handle for maximum performance

UPC	NO.	PKG.
70786 4	707862	Holster/Carded



60004

### 4-PIECE PRECISION BLADE PROBE SET - FIXED BLADE

- For probing, cleaning, picking or marking small work surfaces
- Set includes the most popular mini-tool configurations: • Straight • 180° Hook • 35° Bend • 90° Bend
- Each blade is 2-5/8" (67mm) with an overall length of 6" (152mm)
- Blades constructed of heat treated 8650 Alloy steel (nickel-chromium-molybdenum)
- Precision engineered 600 Series Versa-Grip™ handle for maximum performance

UPC	NO.	PKG.
60004 2	60004	Carded

#### Set contains:

NO.	TYPE	SIZE	BLADE LENGTH
610001B	Probe	Straight Probe	2-5/8"(67mm)
610002B	Probe	35° Bent Probe	2-5/8"(67mm)
610003B	Probe	90° Bent Probe	2-5/8"(67mm)
610004B	Probe	180° Hook Probe	2-5/8"(67mm)

SPECIALTY

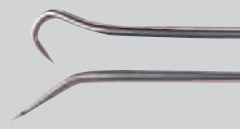

### 3-PIECE PROBE AND HOOK SET

- For probing, cleaning, picking or marking small work surfaces
- Three heat treated, high carbon steel point configurations: 45 degree, double bend and hook bend
- Extra long aluminum knurled body

UPC	NO.	OVERALL LENGTH
24500 7	862	6-1/2" (165mm)



862

### 4-PIECE MICRO PROBE SET

- For probing, cleaning, picking or marking small work surfaces
- Four heat treated, high carbon steel point configurations: 45 degree, two double bends and hook bend
- Extra long aluminum knurled body

UPC	NO.	OVERALL LENGTH
24501 4	868	5-1/2" (138mm)



868

### 12-PIECE STAINLESS STEEL PROBE, POSITIONING & SPRING HOOK SET

- Useful in a wide variety of mechanical and electrical functions
- For separating and positioning wires, inserting and adjusting wires and springs in hard-to-reach areas
- For probing, cleaning, picking or marking small work surfaces
- Heavy-duty locking screw chuck holds blades securely in place
- Each blade is 5" long (127mm); OAL 7-1/2" - 8-1/2" (184mm - 216mm) with handle

UPC	NO.	PKG.
70962 2	707865	Zippered Case/Carded



707865

### 5-PIECE STAINLESS STEEL POSITIONING AND SPRING HOOK SET

- Useful in a wide variety of mechanical and electrical functions
- For separating and positioning wires, inserting and adjusting wires and springs in hard-to-reach areas
- Heavy-duty locking screw chuck holds blades securely in place
- Each blade is approximately 5" long (127mm); OAL 7-1/2" - 8-1/2" (184mm - 216mm) with handle

UPC	NO.	PKG.
75970 2	707863	Holster/Boxed



707863

### PRECISION OILER

- For the exact placement of oil or any other lubricant
- For technicians, contractors, hobbyists and DIY'ers
- Smooth actuator allows for greater control and placement of lubricant
- Generous reservoir

UPC	NO.	OVERALL LENGTH
58900 2	589	5-5/8" (143mm)

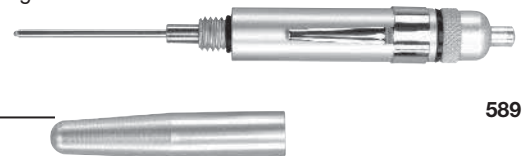

589

### MAGNETIC TORPEDO LEVEL

- Quality crafted torpedo level with large reversible reading vials meets the accuracy requirements of professionals
- Heat resistant, unbreakable endplates and internal aluminum frame
- Readings possible from top, bottom or side positions

UPC	NO.	LENGTH
42698 7	839	9"



839

# SPECIALTY TOOLS

## Voltage Detectors



General's 3-IN-1 LED and LCD Stud, Voltage and Metal Detectors are ideal for locating studs, pipes, wire carrying voltage and hidden metal. Micro-processor control circuits make it easy to distinguish

between battens/studs, metal pipes/tube or objects carrying voltage. An ideal for the DIY home owner, handyman, hobbyist as well a the professional.

81001



### ZIP-TOP TOOL AND METER BAG, 16" WIDE

- Moisture-resistant reinforced bottom
- Steel frame mouth and rivet reinforced for rugged use and durability
- Adjustable padded non-slip shoulder strap
- Dimensions: 12"H x 16"W x 8"D (305 x 406 x 203mm)

UPC	NO.
01319 9	81001

**ULTRATUFF™**  
TOOL BAGS



MSV250



### 3-IN-1 LED STUD / VOLTAGE / METAL DETECTOR

Ideal for Locating Studs, Pipes, Wires Carrying Voltage and Hidden Metal

#### FEATURES:

- Stud, Voltage and Metal Detection combined in one unit
- 4-level low power consuming LED's indicate precise stud detection
- Metal/Voltage Selector Switch provides accuracy in detecting hidden metal or wiring
- Stud Detector can be operated with Metal or Voltage Detector simultaneously
- Easy to distinguish between battens/studs, metal pipes/tubes or objects carrying voltage
- No probe necessary

#### SPECIFICATIONS:

- ◆ Dimensions: 6.1"(L) x 2.6"(W) x 1.3"(D) (155 x 65 x 32mm)
  - ◆ Weight: 6.3oz (178g)
  - ◆ Power Source: 1 "9V" battery (not included)
- Includes: • User's Manual

UPC	NO.
01276 5	MSV250



MSV350D



### DIGITAL 3-IN-1 LCD STUD / VOLTAGE / METAL DETECTOR

Ideal for Locating Studs, Pipes, Wires Carrying Voltage and Hidden Metal

#### FEATURES:

- Selectable Metal, Voltage and Stud detections or Auto Mode to perform 3 functions simultaneously
- Micro-Processor Control Circuits provide precise and accurate detections
- Results shown on LCD with buzzer
- Multi-Scan-Level to pinpoint exact position
- Battery status indicated on LCD
- Auto Power OFF
- Low power consumption
- Ideal for the D. I.Y. Homeowner, Handyman, Hobbyist and Professional

#### SPECIFICATIONS:

- ◆ Dimensions: 6.1"(L) x 2.6"(W) x 1.3"(D) (155 x 65 x 32mm)
  - ◆ Weight: 6.5oz (185g)
  - ◆ Power Source: 1 "9V" battery (not included)
- Includes: • User's Manual

UPC	NO.
01275 8	MSV350D





# RESCUE+ONE™ Auto Emergency Tool +FLASHLIGHT

- Shatters automotive side windows for emergency escapes
- High-visibility red flashing emergency light
- Magnets hold the tool to the vehicle
- Bright white LED flashlight helps you see at night
- Safety blade cuts seat belts
- Includes 3 "AAA" batteries in a convenient battery compartment



UPC	NO.	PKG.
79020 0	7902	Carded



LED Flashlight



Seat Belt Cutter



Glass Breaker



Flashing Hazard Light



Easy Battery Access

"It's Your Job . . . General Tools Make It Easier"

T-115

## **X-ON Electronics**

Largest Supplier of Electrical and Electronic Components

*Click to view similar products for [general tools manufacturer](#):*

Other Similar products are found below :

[565](#) [3601](#) [938](#) [14712](#) [78](#) [70396](#) [S475](#) [79](#) [8075](#) [20](#) [1433](#) [589](#) [807](#) [80557](#) [70079](#) [560RMF](#) [70557](#) [864](#) [93](#) [92](#) [690](#) [386](#) [532](#) [538](#) [612020B](#)  
[8083](#) [94C](#) [707863](#) [80075](#) [395](#) [146](#) [709392](#) [560](#) [505](#) [24](#) [707475](#) [372A](#) [80560](#) [80](#) [383NX](#)