

Bridgelux RS Array Series

Product Data Sheet DS25

**BXRA-xxx-3500-F, BXRA-xxx4000-H, BXRA-xxx7000-J,
BXRA-40E4000-F, BXRA-40E4500-H, BXRA-40E7500-J,
BXRA-xxC4500-F, BXRA-xxC5300-H, BXRA-xxC9000-J**

Introduction

The Bridgelux family of LED Array products delivers high performance, compact and cost-effective solid-state lighting solutions to serve the general lighting market. These products combine the higher efficacy, lifetime, and reliability benefits of LEDs with the light output levels of many conventional lighting sources. The Bridgelux RS Array Series has been specified to enable lamp and luminaire designs with comparable performance to existing high wattage CFL and HID conventional light sources for retail, commercial, industrial and outdoor/street lighting applications. Bridgelux Arrays are ideal for all types of light-on-demand applications, where they can be instantaneously and smoothly dimmed up or down without any effect on lifetime, unlike traditional CFL and HID light sources.

Bridgelux RS Array series are a high performance alternative to conventional solid state solutions, delivering between 3,000 and 10,000 lumens under application conditions in warm, neutral and cool white color temperatures. These compact high flux density light sources deliver uniform high quality illumination without pixilation or the multiple shadow effect caused by LED component based solutions, enabling excellent beam control for precision lighting.

LED array solutions reduce system complexity and enable miniaturized cost-effective designs. Luminaire designs incorporating these LED Arrays deliver system level performance comparable to 42-55 Watt CFL, 35-90 Watt low pressure sodium, 70-150 Watt high pressure sodium or 70-200 Watt metal halide based luminaires and feature increased system level and service life. Typical applications include retail lighting, commercial down lights, high bay, outdoor and street lights, and entertainment lighting.

Features

- Compact high flux density light source
- Uniform high quality illumination
- Minimum 70, 80 and 90 CRI options
- Streamlined thermal path
- Energy Star / ANSI compliant color binning structure with 3SDCM options
- More energy efficient than incandescent, halogen and fluorescent lamps
- Low voltage DC operation
- Instant light with unlimited dimming
- 5-Year warranty
- RoHS compliant and Pb free

Benefits

- Enhanced optical control
- Clean white light without pixilation
- High quality true color reproduction
- Significantly reduced thermal resistance and increased operating temperatures
- Uniform consistent white light
- Lower operating costs
- UL Recognized
- Easy to use with daylight and motion detectors to enable increased energy savings
- Reduced maintenance costs
- Environmentally friendly, no disposal issue

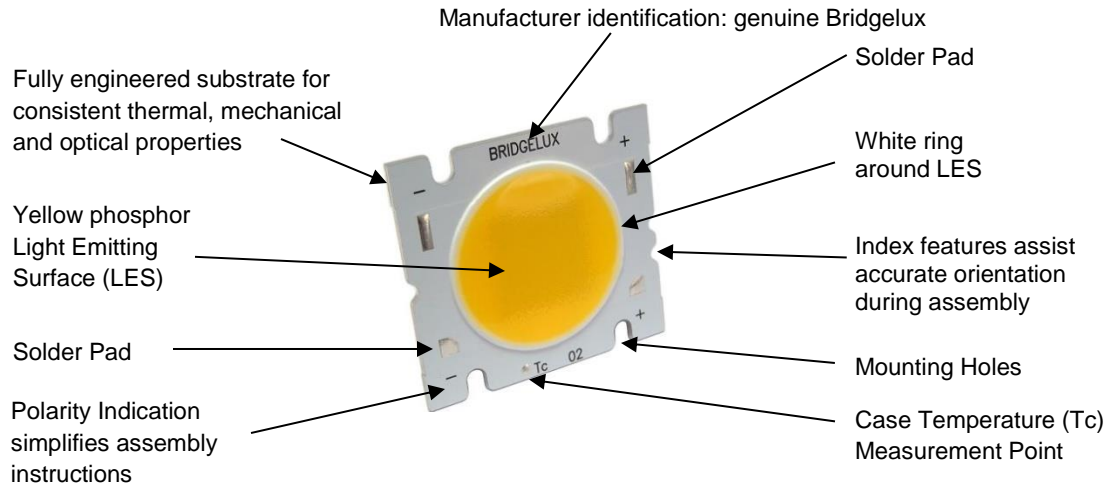

Table of Contents	Page
Typical Product Features	3
Product Nomenclature	3
CE Recognition	4
Selection Guide	6
Typical Performance at Alternative Drive Currents	7
Flux Characteristics	10
Electrical Characteristics	11
Absolute Maximum Ratings	12
Forward Current versus Voltage Characteristics	14
Figure 2: Typical Current vs. Voltage	14
Typical Relative Luminous Flux vs. Current	16
Typical Chromaticity Characteristics vs. Temperature	18
Typical Radiation Pattern	20
Typical Spectral Characteristics	21
Mechanical Dimensions	22
Color Binning Information	23
Color Control Options	26
Design Resources	27
About Bridgelux	28

Typical Product Features

Bridgelux arrays are fully engineered devices that provide consistent thermal and optical performance on an engineered mechanical platform. The RS array is the largest chip-on-board device in the BXRA LED Array product series. The arrays incorporate several features to simplify design integration and assembly.

Figure 1: Array Features



Note: Part number and lot codes are scribed on back of array

Product Nomenclature

The part number designation for Bridgelux LED Arrays is explained as follows:

BXRA – AB C DEFG – H – IJ

Where:

B X R A – Designates product family

A B – Designates the nominal ANSI color temperature; 27 = 2700K; 30 = 3000K, etc.

C - Designates minimum CRI; C = 70, E = 80, G = 90

D E F G - Designates Nominal Flux; 4000 = 4000lm, 7000 = 7000lm, etc.

H – Designates configuration

I J – Designates CCT color binning

03 = 3SDCM or 3-step

04 = 4SDCM or 4-step

00 = 7SDCM or 7-step

Lumen Maintenance Characteristics

Bridgelux projects that its family of LED Array products will deliver, on average, greater than 70% lumen maintenance after 50,000 hours of operation at the rated forward test current. This performance assumes constant current operation at the nominal drive current with case temperature maintained at or below 85°C. For use beyond these typical operating conditions please consult your Bridgelux sales representative for further assistance.

These projections are based on a combination of package test data, semiconductor chip reliability data, a fundamental understanding of package related degradation mechanisms, and performance observed from products installed in the field using Bridgelux die technology. Bridgelux conducts lumen maintenance tests per LM80. Observation of design limits is required in order to achieve this projected lumen maintenance.

Environmental Compliance

Bridgelux is committed to providing environmentally friendly products to the solid state lighting market. Bridgelux LED Arrays comply with the European Union directives on the restriction of hazardous substances in electronic equipment, namely the RoHS directive. Bridgelux does not intentionally add the following restricted materials to LED Array products: lead, mercury, cadmium, hexavalent chromium, polybrominated biphenyls (PBB) or polybrominated diphenyl ethers (PBDE).

UL Recognition

Bridgelux secures UL recognition for all the LED Array products. Please refer to the UL file E350613 for the latest list of UL recognized Arrays. Bridgelux uses UL recognized materials with suitable flammability ratings in the LED Array to streamline the process for customers to secure UL listing of the final luminaire product.

CE Recognition

In accordance with the relevant European Union directives, the family of LED Array products conform to the applicable requirements of the IEC/EN 62031:2008 (LED Modules for General Lighting Safety Specifications) and IEC 62471:2006 (Photobiological Safety of Lamps and Lamp Systems). Bridgelux maintains a CE Declaration of Conformity statement on its website and displays the CE mark on product packing labels.

Minor Product Change Policy

The rigorous qualification testing on products offered by Bridgelux provides performance assurance. Slight cosmetic changes that do not affect form, fit, or function may occur as Bridgelux continues product optimization.

Case Temperature Measurement Point

A case temperature (T_c) measurement point location is included on the top surface of the Bridgelux LED Arrays. The location of this measurement point is indicated in the mechanical dimensions section of this data sheet.

The purpose of this measurement point is to allow the user access to a measurement point closely linked to the true case temperature on the back surface of the LED Array. Once the LED Array is installed, it is challenging to measure the back surface of the array, or true case temperature.

Bridgelux has provided the case temperature measurement location in a manner which closely ties it to the true case temperature of the LED Array under steady state operation. Deviations between thermal measurements taken at the point indicated and the back of the LED Array differ by less than 1°C, providing a robust method to testing thermal operation once the product is installed.

Cautionary Statements

CAUTION: CONTACT WITH OPTICAL AREA

Avoid any contact with the optical area. Do not touch the optical area of the LED Array or apply mechanical stress to the yellow phosphor resin area – it could damage the LED Array.

Optics and reflectors must not be mounted in contact with the yellow phosphor resin area (LES) or the white ring that surrounds the yellow phosphor area. Using the white ring to secure optics can result in damage to the LED Array as the ring is not designed to act as a mechanical locating feature. Optical devices may be mounted on the top surface of the LED Array substrate outside of the white ring maximum OD as specified in the product data sheet. Use the mechanical features of the LED Array substrate edges and/or mounting holes to locate and secure the optical device as needed.

CAUTION: EYE SAFETY

Eye safety classification for the use of Bridgelux LED Arrays is in accordance with IEC specification EN62471; Photobiological Safety of Lamps and Lamp Systems. Bridgelux LED Arrays are classified as Risk Group 1 (Low Risk) when operated at or below their rated test current. Please use appropriate precautions. It is important that employees working with LEDs are trained to use them safely.

CAUTION: RISK OF BURN

Do not touch the LED Array or resin area during operation. Allow the LED Array to cool for a sufficient period of time before handling. The LED Array may reach elevated temperatures such that it can burn skin when touched.

CAUTION: CHEMICAL EXPOSURE HAZARD

Exposure to some chemicals commonly used in luminaire manufacturing and assembly can cause damage to the LED Array. Please consult Application Note AN11 for additional information.

Selection Guide

The following configurations are available:

Table 1: Selection Guide for RS Arrays

Part Number ^[1]	CCT ^[2] (Kelvin)	CRI ^[3,4]	Test Current ^[5] (mA)	Typical Voltage (V)	Typical Flux ^[6] (lm)		Typical Power ^[6] (W)	Typical Efficacy ^[6] (lm/W)
					T _j = 25°C	T _{case} = 85°C		
BXRA-27E3500-F-03	2700K	80	1750	17.9	2900	2520	31.3	93
BXRA-27E4000-H-03	2700K	80	2100	23.5	4640	4040	49.4	94
BXRA-27E7000-J-03	2700K	80	2800	29.4	7320	6370	82.3	89
BXRA-27G3500-F-03	2700K	90	1750	17.9	2520	2190	31.3	80
BXRA-27G4000-H-03	2700K	90	2100	23.5	3960	3440	49.4	80
BXRA-27G7000-J-03	2700K	90	2800	29.4	6280	5460	82.3	76
BXRA-30E3500-F-03	3000K	80	1750	17.9	3150	2740	31.3	101
BXRA-30E4000-H-03	3000K	80	2100	23.5	5040	4380	49.4	102
BXRA-30E7000-J-03	3000K	80	2800	29.4	8050	7000	82.3	98
BXRA-30G3500-F-03	3000K	90	1750	17.9	2790	2430	31.3	89
BXRA-30G4000-H-03	3000K	90	2100	23.5	4260	3700	49.4	86
BXRA-30G7000-J-03	3000K	90	2800	29.4	6800	5910	82.3	83
BXRA-35E3500-F-03	3500K	80	1750	17.9	3280	2850	31.3	105
BXRA-35E4000-H-03	3500K	80	2100	23.5	5340	4640	49.4	108
BXRA-35E7000-J-03	3500K	80	2800	29.4	8530	7420	82.3	104
BXRA-40E4000-F-03	4000K	80	1750	17.9	3530	3070	31.3	113
BXRA-40E4500-H-03	4000K	80	2100	23.5	5700	4960	49.4	116
BXRA-40E7500-J-03	4000K	80	2800	29.4	9010	7840	82.3	109
BXRA-50C4500-F-xx	5000K	70	1750	17.9	3940	3430	31.3	126
BXRA-50C5300-H-xx	5000K	70	2100	23.5	6300	5480	49.4	128
BXRA-50C9000-J-xx	5000K	70	2800	29.4	10060	8750	82.3	122
BXRA-56C4500-F-xx	5600K	70	1750	17.9	3840	3340	31.3	123
BXRA-56C5300-H-xx	5600K	70	2100	23.5	6300	5480	49.4	128
BXRA-56C9000-J-xx	5600K	70	2800	29.4	10060	8750	82.3	122

Note for Table 1 through 5 (additional specific notes following Table 2 through 5):

1. Part numbers with “-xx” suffix are available with multiple color control options (4 SDCM or 7 SDCM for example).
2. Nominal CCT as defined by ANSI C78.377-2011.
3. Values are minimum.
4. Minimum R9 value for 90 CRI products is 50.
5. Products tested under pulsed condition (10ms pulse width) at rated test current where T_{junction} = T_{case} = 25°C.
6. Typical performance values are provided as a reference only and are not a guarantee of performance.
7. Bridgelux maintains a ±7% tolerance on flux measurements.
8. Operating these LED Arrays at or below the drive currents listed in Table 2 and 5, with a case temperature maintained at or below 85°C, will enable the average lumen maintenance projection outlined earlier in this Product Data Sheet.

Typical Performance at Alternative Drive Currents

Customers may drive the LED Arrays at alternative drive currents dependent on the specific application. The typical performance at any drive current can be derived from the current vs. voltage characteristics shown in Figures 2 and 3 and from the flux versus current characteristics shown in Figure 8 and 9. The typical performance at common drive currents is summarized in Table 2.

Table 2: Typical Product Performance at Alternative Drive Currents

Part Number ^[1]	CCT & CRI	Current ^[9] (mA)	Typical Voltage ^[6] (V)	Typical Power ^[6] (W)	Typical Flux ^[6] (lm)		Typical Efficacy ^[6] (lm/W)
			T _j = 25°C	T _j = 25°C	T _j = 25°C	T _{case} = 85°C	T _j = 25°C
BXRA-27E3500-F-03	2700K and 80 CRI	1050	17.2	18.0	1820	1580	101
		1400	17.5	24.5	2370	2060	97
		1750	17.9	31.3	2900	2520	93
		2100	18.3	38.3	3410	2970	89
BXRA-27E4000-H-03	2700K and 80 CRI	1400	22.7	31.7	3170	2760	100
		1750	23.1	40.4	3920	3410	97
		2100	23.5	49.4	4640	4040	94
		2450	23.8	58.4	5230	4550	90
BXRA-27E7000-J-03	2700K and 80 CRI	1400	27.8	38.9	3770	3280	97
		2100	28.6	60.1	5590	4870	93
		2800	29.4	82.3	7320	6370	89
		3150	29.7	93.7	8060	7020	86
BXRA-27G3500-F-03	2700K and 90 CRI	1050	17.2	18.0	1580	1370	88
		1400	17.5	24.5	2060	1790	84
		1750	17.9	31.3	2520	2190	80
		2100	18.3	38.3	2970	2580	77
BXRA-27G4000-H-03	2700K and 90 CRI	1400	22.7	31.7	2700	2350	85
		1750	23.1	40.4	3340	2900	83
		2100	23.5	49.4	3960	3440	80
		2450	23.8	58.4	4460	3880	76
BXRA-27G7000-J-03	2700K and 90 CRI	1400	27.8	38.9	3240	2820	83
		2100	28.6	60.1	4800	4170	80
		2800	29.4	82.3	6280	5460	76
		3150	29.7	93.7	6920	6010	74
BXRA-30E3500-F-03	3000K and 80 CRI	1050	17.2	18.0	1980	1720	110
		1400	17.5	24.5	2570	2240	105
		1750	17.9	31.3	3150	2740	101
		2100	18.3	38.3	3710	3220	97
BXRA-30E4000-H-03	3000K and 80 CRI	1400	22.7	31.7	3440	2990	108
		1750	23.1	40.4	4250	3700	105
		2100	23.5	49.4	5040	4380	102
		2450	23.8	58.4	5680	4930	97

Table 2 Continued

Part Number ^[1]	CCT & CRI	Current ^[9] (mA)	Typical Voltage ^[6] (V)	Typical Power ^[6] (W)	Typical Flux ^[6] (lm)		Typical Efficacy ^[6] (lm/W)
			T _j = 25°C	T _j = 25°C	T _j = 25°C	T _{case} = 85°C	T _j = 25°C
BXRA-30E7000-J-03	3000K and 80 CRI	1400	27.8	38.9	4150	3610	107
		2100	28.6	60.1	6150	5350	102
		2800	29.4	82.3	8050	7000	98
		3150	29.7	93.7	8870	7710	95
BXRA-30G3500-F-03	3000K and 90 CRI	1050	17.2	18.0	1750	1530	97
		1400	17.5	24.5	2280	1990	93
		1750	17.9	31.3	2790	2430	89
		2100	18.3	38.3	3280	2860	86
BXRA-30G4000-H-03	3000K and 90 CRI	1400	22.7	31.7	2910	2530	92
		1750	23.1	40.4	3600	3120	89
		2100	23.5	49.4	4260	3700	86
		2450	23.8	58.4	4800	4170	82
BXRA-30G7000-J-03	3000K and 90 CRI	1400	27.8	38.9	3510	3050	90
		2100	28.6	60.1	5200	4520	87
		2800	29.4	82.3	6800	5910	83
		3150	29.7	93.7	7490	6510	80
BXRA-35E3500-F-03	3500K and 80 CRI	1050	17.2	18.0	2060	1790	114
		1400	17.5	24.5	2680	2330	109
		1750	17.9	31.3	3280	2850	105
		2100	18.3	38.3	3860	3350	101
BXRA-35E4000-H-03	3500K and 80 CRI	1400	22.7	31.7	3650	3170	115
		1750	23.1	40.4	4510	3920	112
		2100	23.5	49.4	5340	4640	108
		2450	23.8	58.4	6020	5230	103
BXRA-35E7000-J-03	3500K and 80 CRI	1400	27.8	38.9	4400	3830	113
		2100	28.6	60.1	6520	5670	108
		2800	29.4	82.3	8530	7420	104
		3150	29.7	93.7	9400	8170	100
BXRA-40E4000-F-03	4000K and 80 CRI	1050	17.2	18.0	2220	1930	123
		1400	17.5	24.5	2890	2510	118
		1750	17.9	31.3	3530	3070	113
		2100	18.3	38.3	4150	3610	108
BXRA-40E4500-H-03	4000K and 80 CRI	1400	22.7	31.7	3890	3390	123
		1750	23.1	40.4	4810	4190	119
		2100	23.5	49.4	5700	4960	116
		2450	23.8	58.4	6420	5590	110

Table 2 Continued

Part Number ^[1]	CCT & CRI	Current ^[9] (mA)	Typical Voltage ^[6] (V)	Typical Power ^[6] (W)	Typical Flux ^[6] (lm)		Typical Efficacy ^[6] (lm/W)
			T _j = 25°C	T _j = 25°C	T _j = 25°C	T _{case} = 85°C	T _j = 25°C
BXRA-40E7500-J-03	4000K and 80 CRI	1400	27.8	38.9	4650	4040	119
		2100	28.6	60.1	6880	5990	114
		2800	29.4	82.3	9010	7840	109
		3150	29.7	93.7	9920	8640	106
BXRA-50C4500-F-xx	5000K and 70 CRI	1050	17.2	18.0	2470	2150	137
		1400	17.5	24.5	3220	2800	131
		1750	17.9	31.3	3940	3430	126
		2100	18.3	38.3	4640	4040	121
BXRA-50C5300-H-xx	5000K and 70 CRI	1400	22.7	31.7	4300	3740	136
		1750	23.1	40.4	5320	4620	132
		2100	23.5	49.4	6300	5480	128
		2450	23.8	58.4	7100	6170	122
BXRA-50C9000-J-xx	5000K and 70 CRI	1400	27.8	38.9	5190	4510	133
		2100	28.6	60.1	7690	6690	128
		2800	29.4	82.3	10060	8750	122
		3150	29.7	93.7	11080	9640	118
BXRA-56C4500-F-xx	5600K and 70 CRI	1050	17.2	18.0	2410	2100	134
		1400	17.5	24.5	3140	2730	128
		1750	17.9	31.3	3840	3340	123
		2100	18.3	38.3	4520	3930	118
BXRA-56C5300-H-xx	5600K and 70 CRI	1400	22.7	31.7	4300	3740	136
		1750	23.1	40.4	5320	4620	132
		2100	23.5	49.4	6300	5480	128
		2450	23.8	58.4	7100	6170	122
BXRA-56C9000-J-xx	5600K and 70 CRI	1400	27.8	38.9	5190	4510	133
		2100	28.6	60.1	7690	6690	128
		2800	29.4	82.3	10060	8750	122
		3150	29.7	93.7	11080	9640	118

Notes for Table 2:

9. Values in **bold** correspond to rated test currents from Table 1. Alternate values are provided for reference only and are not guaranteed.

Flux Characteristics

Table 3: Flux Characteristics

Part Number ^[1]	CCT ^[2] (Kelvin)	CRI ^[3]	Test Current ^[5] (mA)	Minimum Flux ^[5] (lm)	Minimum Flux ^[10] (lm)	Typical Flux ^[6] (lm)	Typical CBCP ^[11] (cd)
				T _j = 25°C	T _{case} = 85°C	T _{case} = 85°C	T _j = 25°C
BXRA-27E3500-F-03	2700K	80	1750	2565	2230	2520	920
BXRA-27E4000-H-03	2700K	80	2100	4090	3560	4040	1480
BXRA-27E7000-J-03	2700K	80	2800	6450	5610	6370	2330
BXRA-27G3500-F-03	2700K	90	1750	2270	1970	2190	800
BXRA-27G4000-H-03	2700K	90	2100	3490	3030	3440	1260
BXRA-27G7000-J-03	2700K	90	2800	5530	4810	5460	2000
BXRA-30E3500-F-03	3000K	80	1750	2830	2460	2740	1000
BXRA-30E4000-H-03	3000K	80	2100	4440	3860	4380	1600
BXRA-30E7000-J-03	3000K	80	2800	7090	6170	7000	2560
BXRA-30G3500-F-03	3000K	90	1750	2500	2180	2430	890
BXRA-30G4000-H-03	3000K	90	2100	3750	3260	3700	1360
BXRA-30G7000-J-03	3000K	90	2800	5990	5210	5910	2160
BXRA-35E3500-F-03	3500K	80	1750	2890	2510	2850	1040
BXRA-35E4000-H-03	3500K	80	2100	4700	4080	4640	1700
BXRA-35E7000-J-03	3500K	80	2800	7510	6530	7420	2720
BXRA-40E4000-F-03	4000K	80	1750	3110	2700	3070	1120
BXRA-40E4500-H-03	4000K	80	2100	5020	4370	4960	1810
BXRA-40E7500-J-03	4000K	80	2800	7930	6900	7840	2870
BXRA-50C4500-F-xx	5000K	70	1750	3470	3020	3430	1250
BXRA-50C5300-H-xx	5000K	70	2100	5550	4830	5480	2010
BXRA-50C9000-J-xx	5000K	70	2800	8860	7710	8750	3200
BXRA-56C4500-F-xx	5600K	70	1750	3385	2940	3340	1220
BXRA-56C5300-H-xx	5600K	70	2100	5550	4830	5480	2010
BXRA-56C9000-J-xx	5600K	70	2800	8860	7710	8750	3200

Notes for Table 3:

10. Minimum flux values at elevated temperatures are provided for reference only and are not guaranteed by 100% production testing. Based on Bridgelux test setup, values may vary depending on the thermal design of the luminaire and/or the environment in which the product is operated.
11. Center beam candle power is a calculated value based on a Lambertian radiation pattern at the rated test current.

Electrical Characteristics

Table 4: Electrical Characteristics

Part Number ^[1]	Test Current ^[5] (mA)	Operating Voltage $T_j = 25^\circ\text{C}$ ^[5, 12] (V)			Typical Coefficient of Forward Voltage ^[13] (mV/°C) $\Delta V_f/\Delta T_j$	Typical Thermal Resistance Junction to Case (°C/W) $R_{\theta j-c}$
		Minimum	Typical	Maximum		
BXRA-27E3500-F-03	1750	16.1	17.9	19.7	-6 to -18	0.46
BXRA-27E4000-H-03	2100	21.1	23.5	25.8	-8 to -24	0.31
BXRA-27E7000-J-03	2800	26.4	29.4	32.3	-10 to -30	0.26
BXRA-27G3500-F-03	1750	16.1	17.9	19.7	-6 to -18	0.46
BXRA-27G4000-H-03	2100	21.1	23.5	25.8	-8 to -24	0.31
BXRA-27G7000-J-03	2800	26.4	29.4	32.3	-10 to -30	0.26
BXRA-30E3500-F-03	1750	16.1	17.9	19.7	-6 to -18	0.46
BXRA-30E4000-H-03	2100	21.1	23.5	25.8	-8 to -24	0.31
BXRA-30E7000-J-03	2800	26.4	29.4	32.3	-10 to -30	0.26
BXRA-30G3500-F-03	1750	16.1	17.9	19.7	-6 to -18	0.46
BXRA-30G4000-H-03	2100	21.1	23.5	25.8	-8 to -24	0.31
BXRA-30G7000-J-03	2800	26.4	29.4	32.3	-10 to -30	0.26
BXRA-35E3500-F-03	1750	16.1	17.9	19.7	-6 to -18	0.46
BXRA-35E4000-H-03	2100	21.1	23.5	25.8	-8 to -24	0.31
BXRA-35E7000-J-03	2800	26.4	29.4	32.3	-10 to -30	0.26
BXRA-40E4000-F-03	1750	16.1	17.9	19.7	-6 to -18	0.46
BXRA-40E4500-H-03	2100	21.1	23.5	25.8	-8 to -24	0.31
BXRA-40E7500-J-03	2800	26.4	29.4	32.3	-10 to -30	0.26
BXRA-50C4500-F-xx	1750	16.1	17.9	19.7	-6 to -18	0.46
BXRA-50C5300-H-xx	2100	21.1	23.5	25.8	-8 to -24	0.31
BXRA-50C9000-J-xx	2800	26.4	29.4	32.3	-10 to -30	0.26
BXRA-56C4500-F-xx	1750	16.1	17.9	19.7	-6 to -18	0.46
BXRA-56C5300-H-xx	2100	21.1	23.5	25.8	-8 to -24	0.31
BXRA-56C9000-J-xx	2800	26.4	29.4	32.3	-10 to -30	0.26

Notes for Table 4:

12. Bridgelux maintains a tester tolerance of ± 0.10 V on forward voltage measurements. Voltage minimum and maximum values at the rated test current are guaranteed by 100% test.
13. Typical Coefficient of Forward Voltage maintains a tolerance of ± 0.1 from nominal current.

Absolute Maximum Ratings

Table 5: Maximum Current and Reverse Voltage Ratings

CCT ^[2] (Kelvin)	Part Number ^[1]	DC Forward Current for LM-80 (mA) ^[4,5,6]	Maximum Peak Pulsed Current (mA) ^[14, 16]	Maximum Reverse Voltage (Vr) ^[15]
2700K	BXRA-27E3500-F-03	2250	3000	-30
	BXRA-27G3500-F-03	2250	3000	-30
	BXRA-27E4000-H-03	3000	4000	-40
	BXRA-27G4000-H-03	3000	4000	-40
	BXRA-27E7000-J-03	3750	5000	-50
	BXRA-27G7000-J-03	3750	5000	-50
3000K	BXRA-30E3500-F-03	2250	3000	-30
	BXRA-30G3500-F-03	2250	3000	-30
	BXRA-30E4000-H-03	3000	4000	-40
	BXRA-30G4000-H-03	3000	4000	-40
	BXRA-30E7000-J-03	3750	5000	-50
	BXRA-30G7000-J-03	3750	5000	-50
3500K	BXRA-35E3500-F-03	2250	3000	-30
	BXRA-35E4000-H-03	3000	4000	-40
	BXRA-35E7000-J-03	3750	5000	-50
4000K	BXRA-40E4000-F-03	2250	3000	-30
	BXRA-40E4500-H-03	3000	4000	-40
	BXRA-40E7500-J-03	3750	5000	-50
5000K	BXRA-50C4500-F-xx	2250	3000	-30
	BXRA-50C5300-H-xx	3000	4000	-40
	BXRA-50C9000-J-xx	3750	5000	-50
5600K	BXRA-56C4500-F-xx	2250	3000	-30
	BXRA-56C5300-H-xx	3000	4000	-40
	BXRA-56C9000-J-xx	3750	5000	-50

Notes for Table 5:

14. Bridgelux recommends a maximum duty cycle of 10% when operating LED Arrays at the maximum peak pulsed current specified.
15. Light emitting diodes are not designed to be driven in reverse voltage.
16. Maximum peak pulsed currents are values at which the LED Array can be driven without catastrophic failures.
17. DC Forward Current for LM-80 are the maximum drive currents for which LM-80 data is currently available
18. Lumen maintenance (L70) and lifetime predictions are valid for drive current and case temperature conditions used for LM-80 testing as included in the applicable LM-80 test report for these arrays.
19. Arrays can be driven at higher currents but lumen maintenance may be reduced

Absolute Maximum Ratings (continued)

Table 6: Maximum Ratings

Parameter	Maximum Rating
LED Junction Temperature	150°C
Storage Temperature	-40°C to +105°C
Operating Case Temperature	105°C
Soldering Temperature ^[1]	350°C or lower for a maximum of 3.5 seconds

Note for Table 6:

20. Refer to Bridgelux Application Note AN15: Reflow soldering of Bridgelux LED Arrays for solder procedure (www.Bridgelux.com)

Forward Current versus Voltage Characteristics

Figure 2: Typical Current vs. Voltage

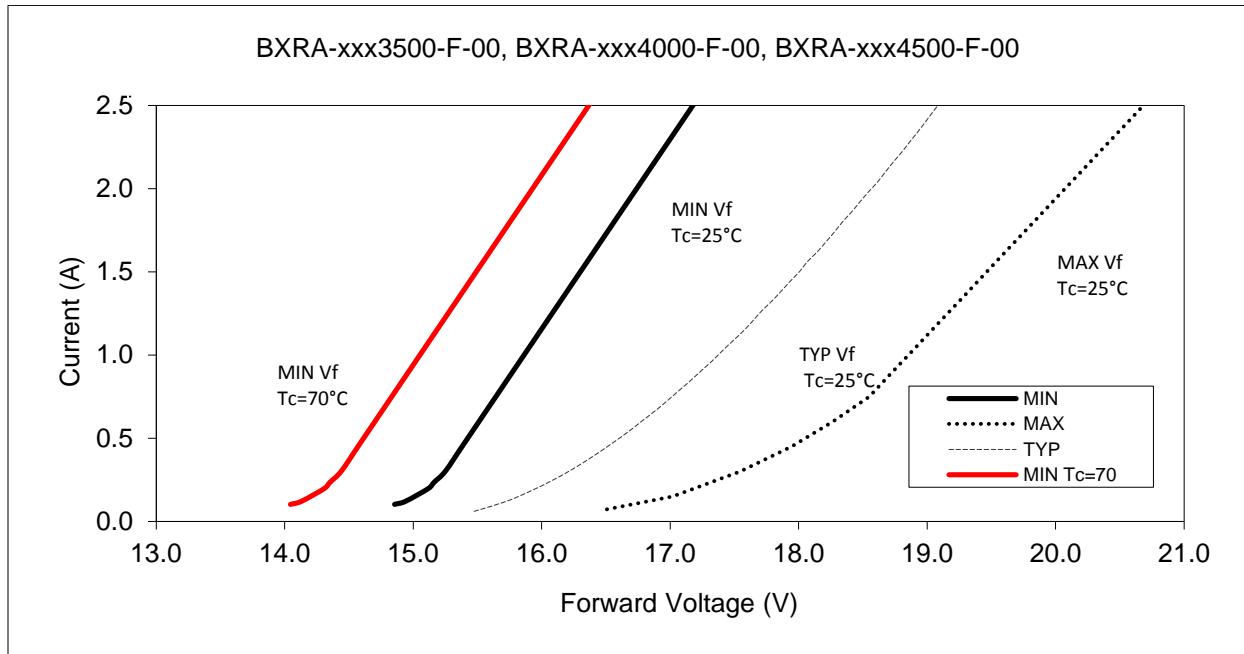
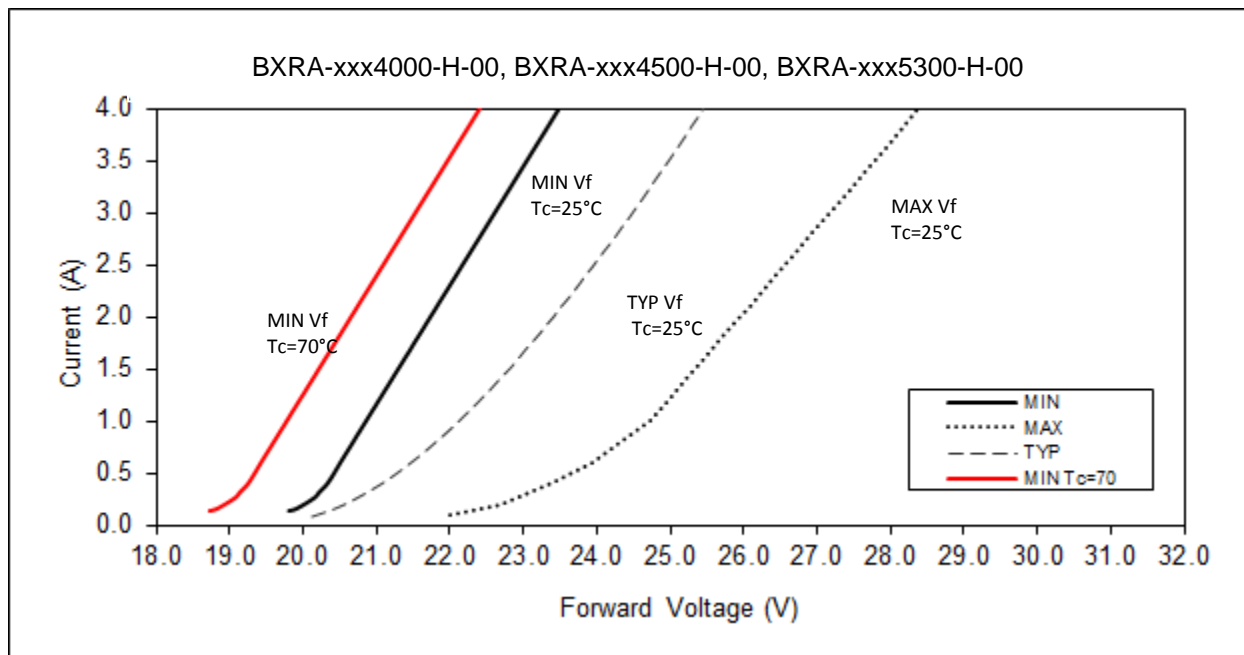
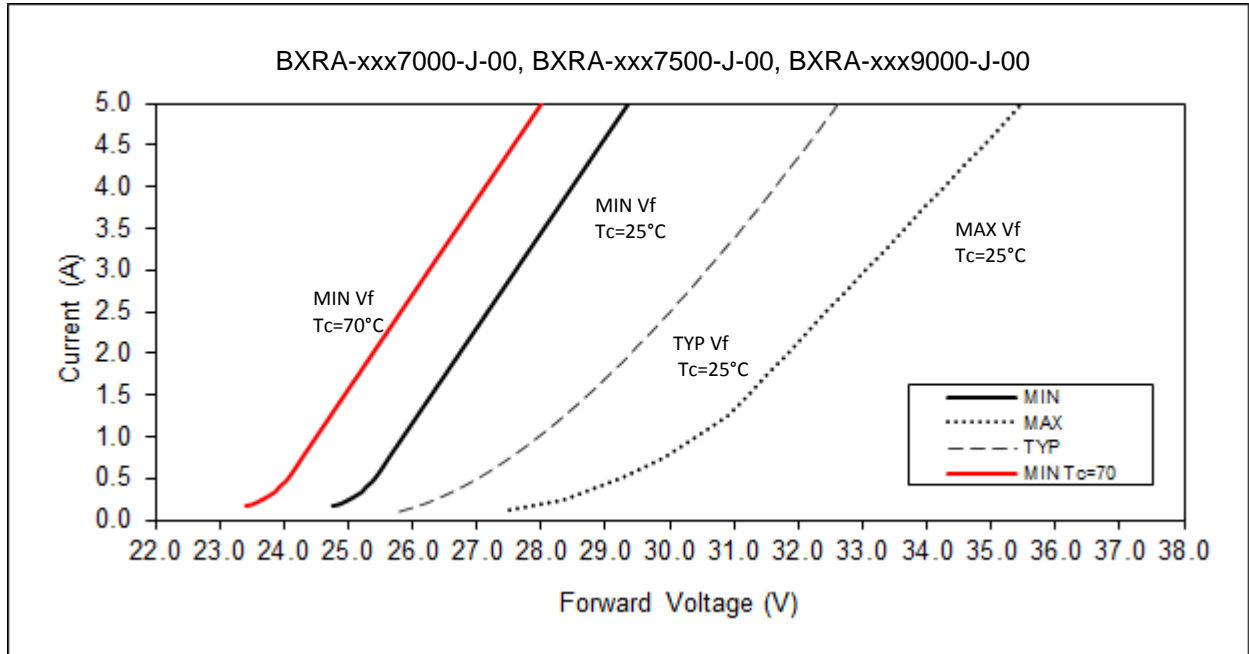

Figure 3: Typical Current vs. Voltage



Forward Voltage versus Current Characteristics (continued)

Figure 4: Typical Current vs. Voltage



Typical Relative Luminous Flux vs. Current

Typical performance at any drive current can be derived from the current versus voltage characteristics shown in Figures 2, 3, and 4 and the flux versus current characteristics shown in Figures 5 and 6. Figure 5 and 6 represent typical performance when pulsed at a junction temperature of 25 degrees Celsius.

Figure 5: Typical Flux vs. Current

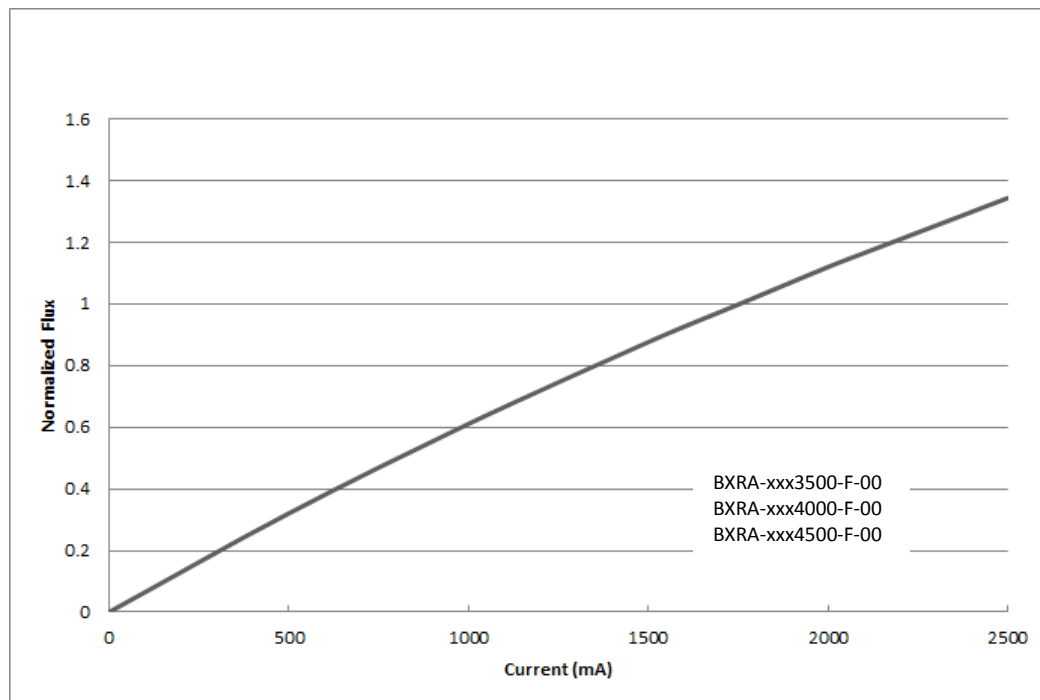

Typical Relative Luminous Flux vs Current (continued)

Figure 6: Typical Flux vs. Current

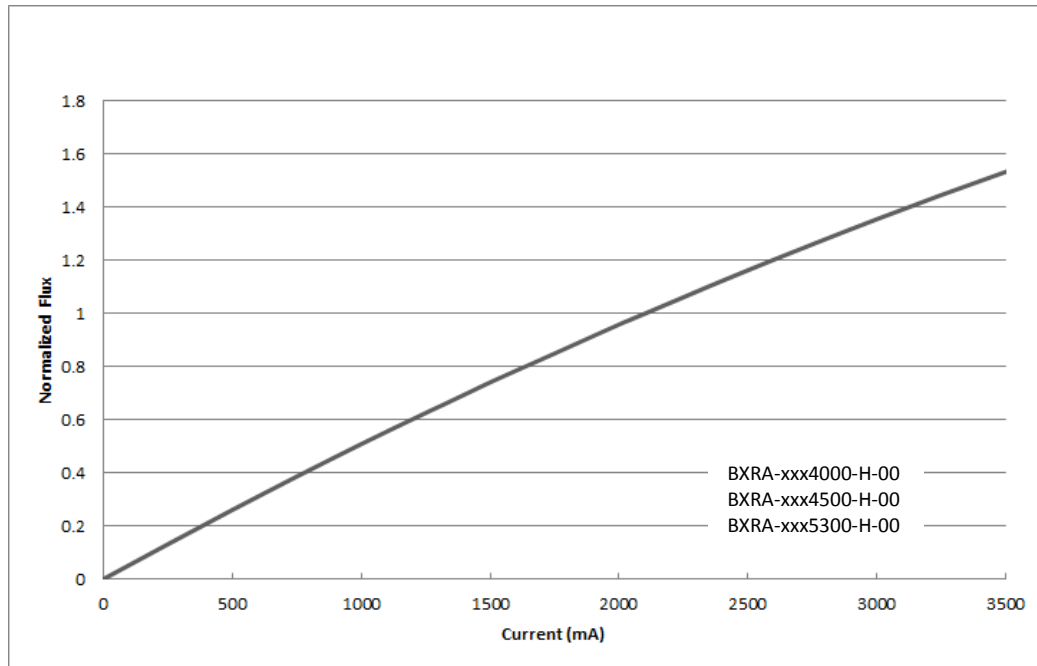
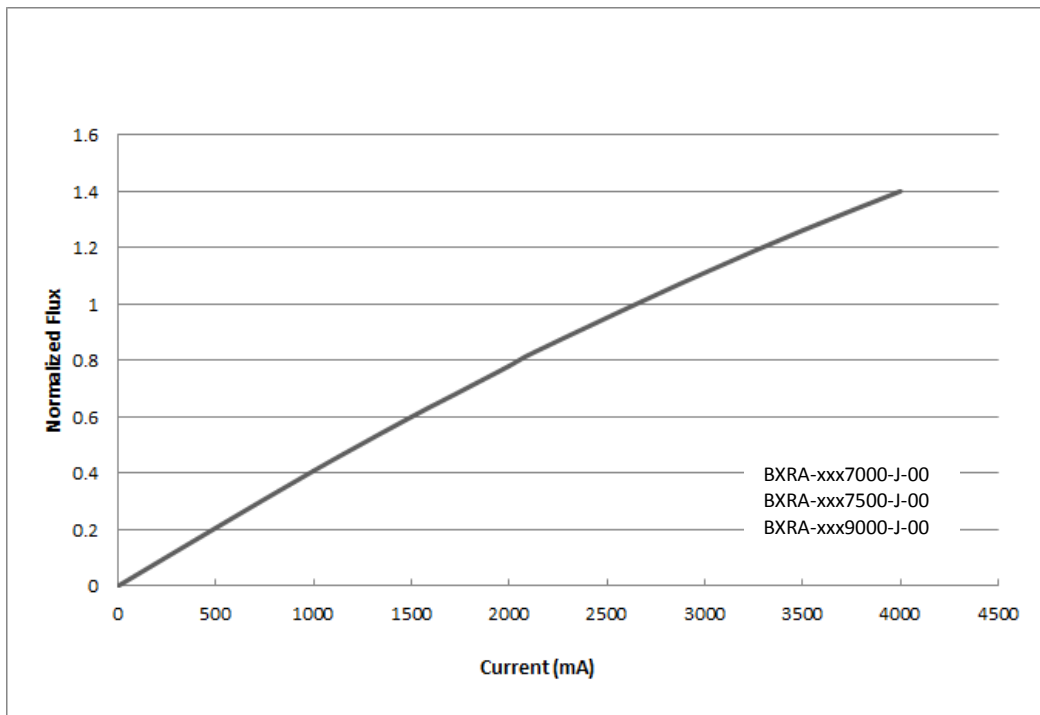
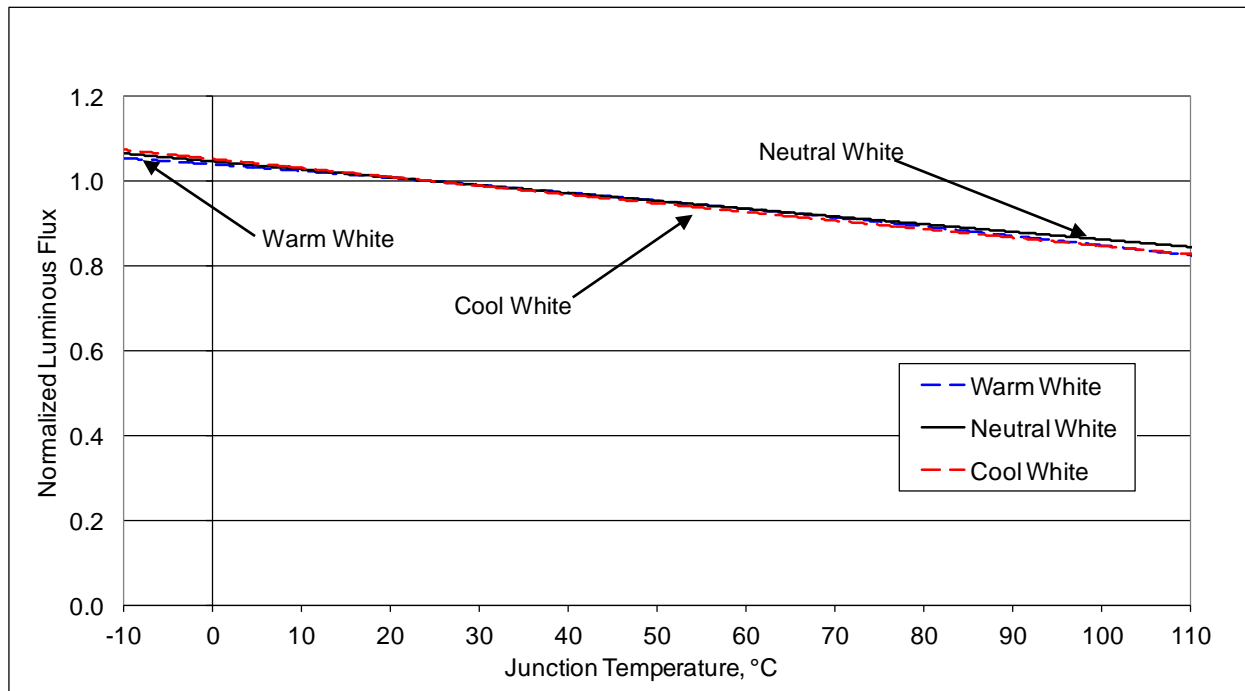

Figure 7: Typical Flux vs. Current



Typical Chromaticity Characteristics vs. Temperature

Figure 8: Typical Flux vs. Junction Temperature



Notes for Figures 8, 9 and 10:

1. Characteristics shown for Warm White 3000K 80CRI
2. Characteristics shown for Neutral White 4000K 80CRI
3. Characteristics shown for Neutral White 5000K 70CRI

Typical Chromaticity Characteristics vs. Temperature (continued)

Figure 9: Typical ccy Shift vs. Junction Temperature

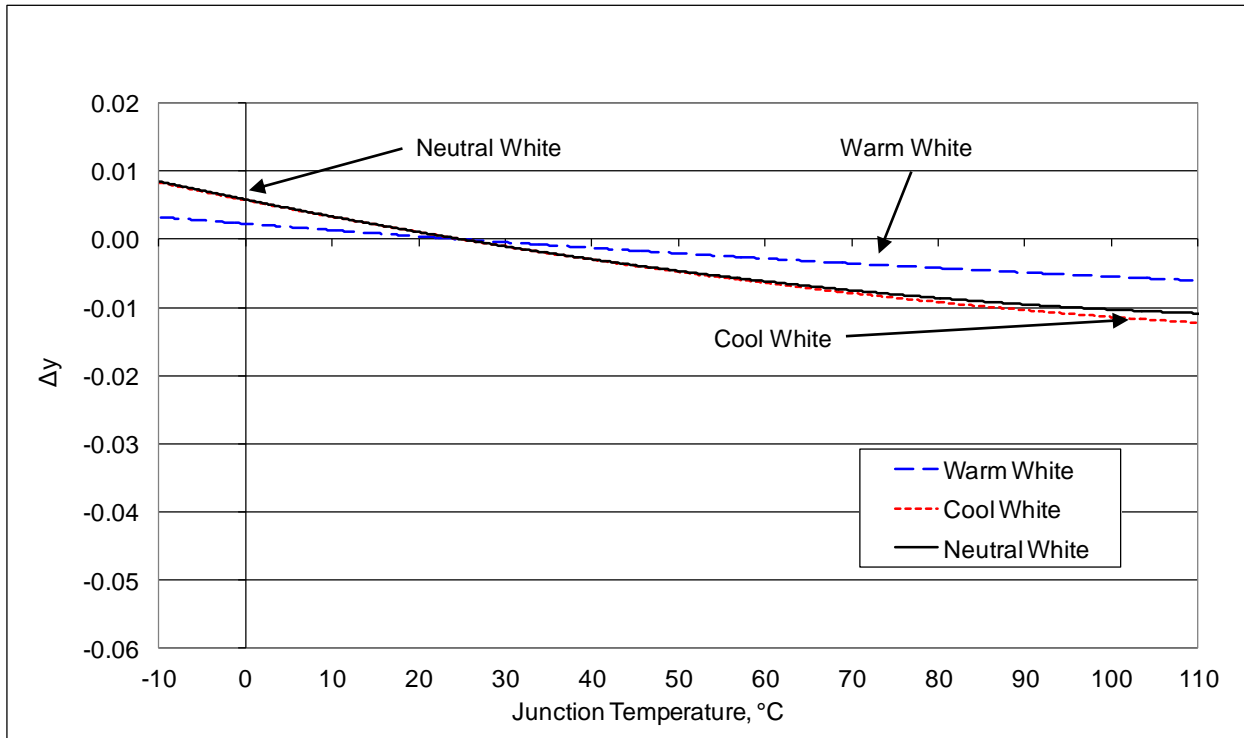
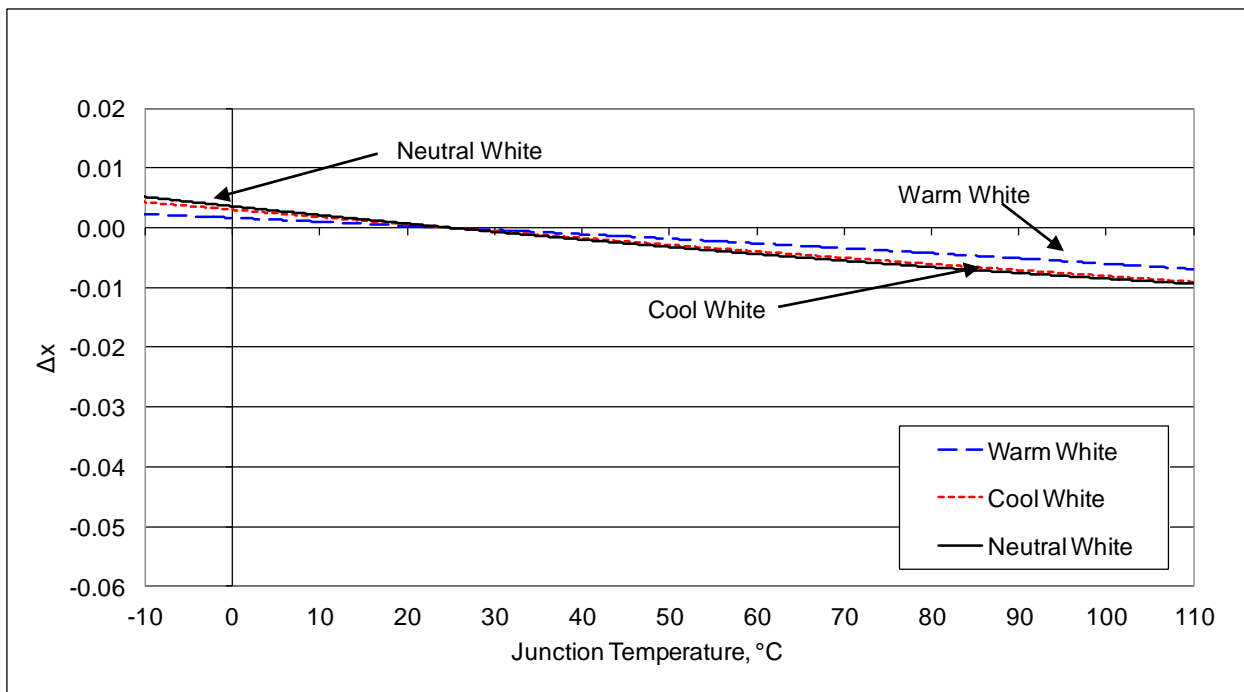
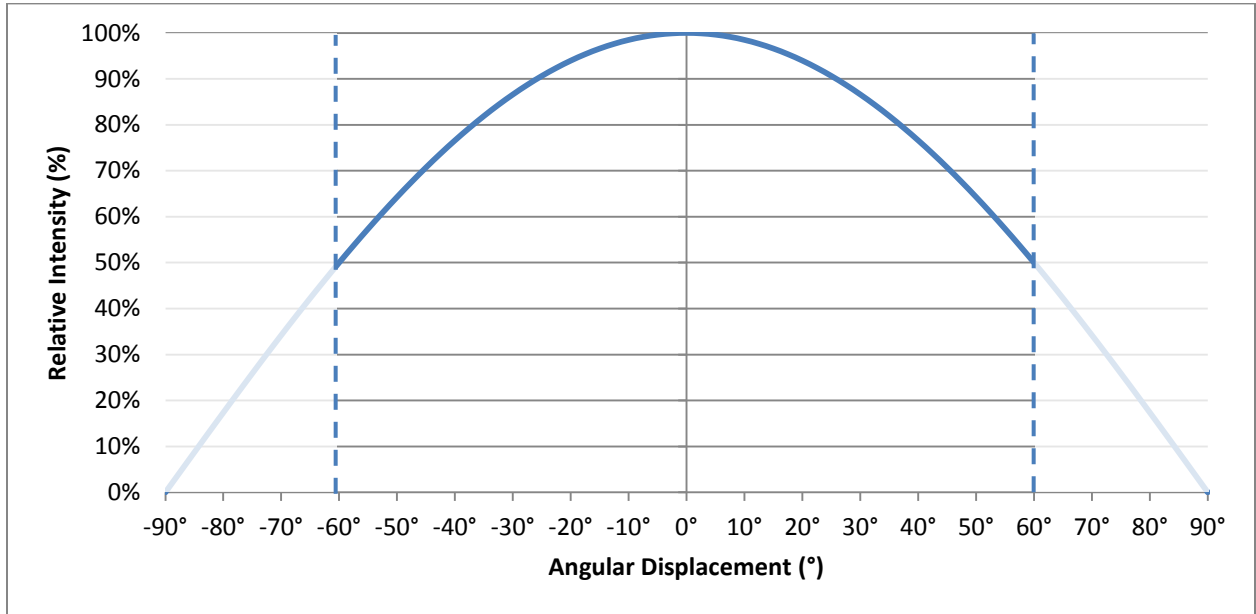

Figure 10: Typical ccx Shift vs. Junction Temperature



Typical Radiation Pattern

Figure 11: Typical Spatial Radiation



Notes for figure 11:

1. Typical viewing angle is 120°
2. Viewing angle is defined as the off axis angle from the centerline where vertical intensity is ½ of the peak intensity value.

Figure 12: Typical Polar Radiation Pattern

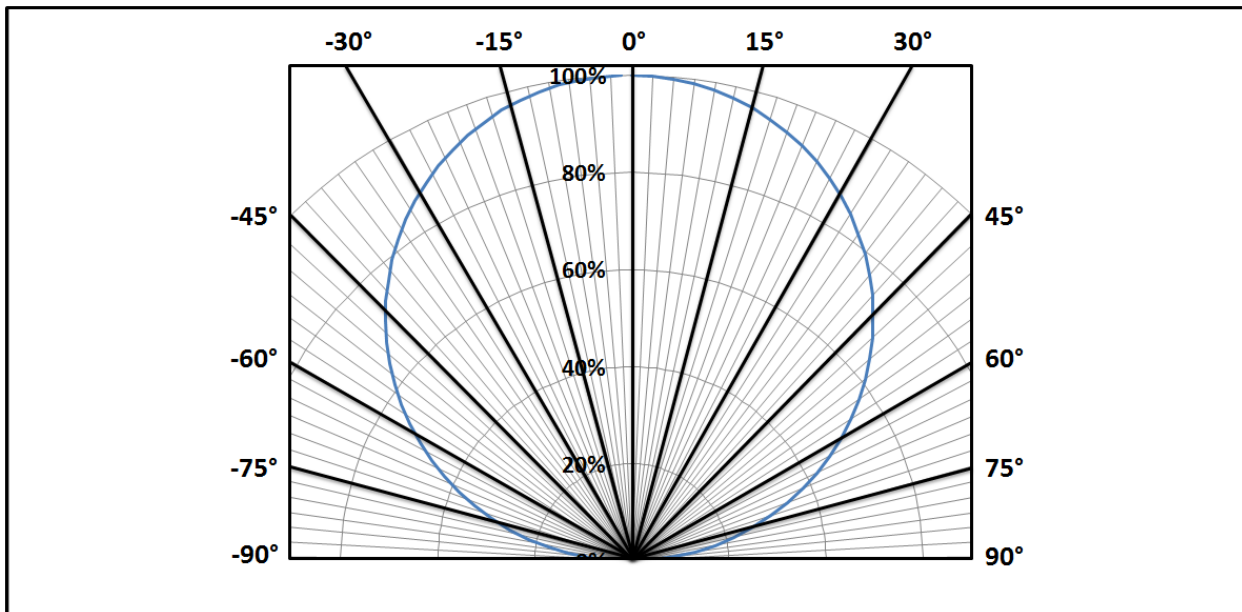

Typical Spectral Characteristics

Figure 13: Typical Color Spectrum

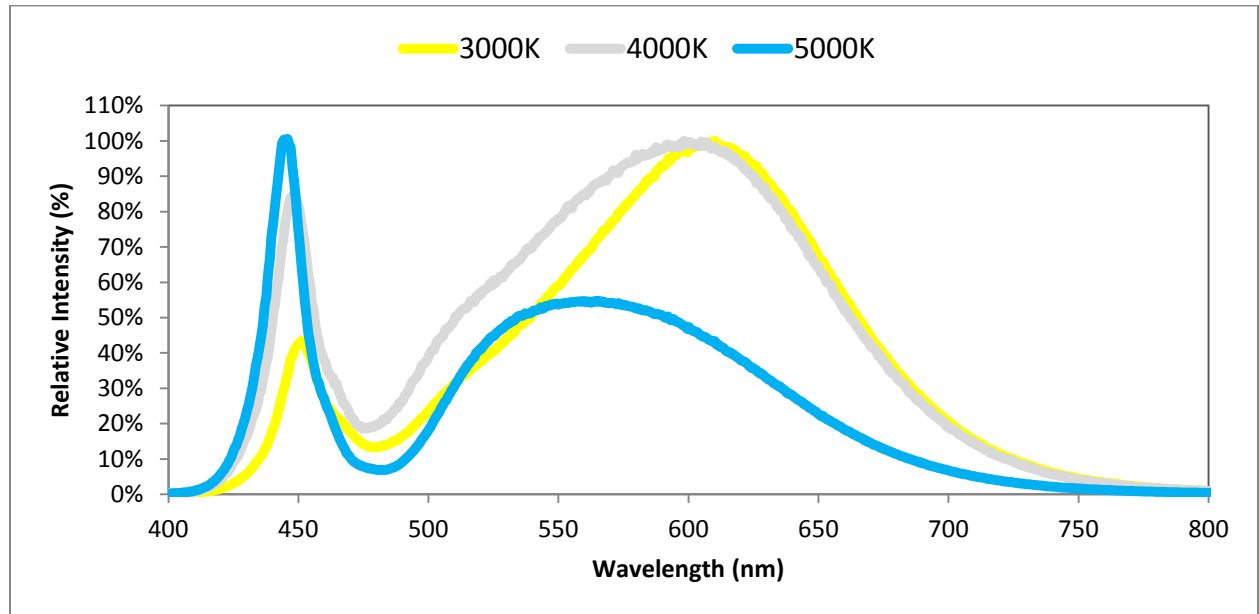

Notes for Figure 13:

1. Color spectra measured at rated current and $T_j = 25^\circ\text{C}$.
2. Color spectrum shown for warm white is 3000K and 80 CRI.
3. Color spectrum shown for neutral white is 4000K and 80 CRI.
4. Color spectrum shown for cool white is 5000K and 70 CRI.

Mechanical Dimensions

Figure 14: Drawing for RS Arrays

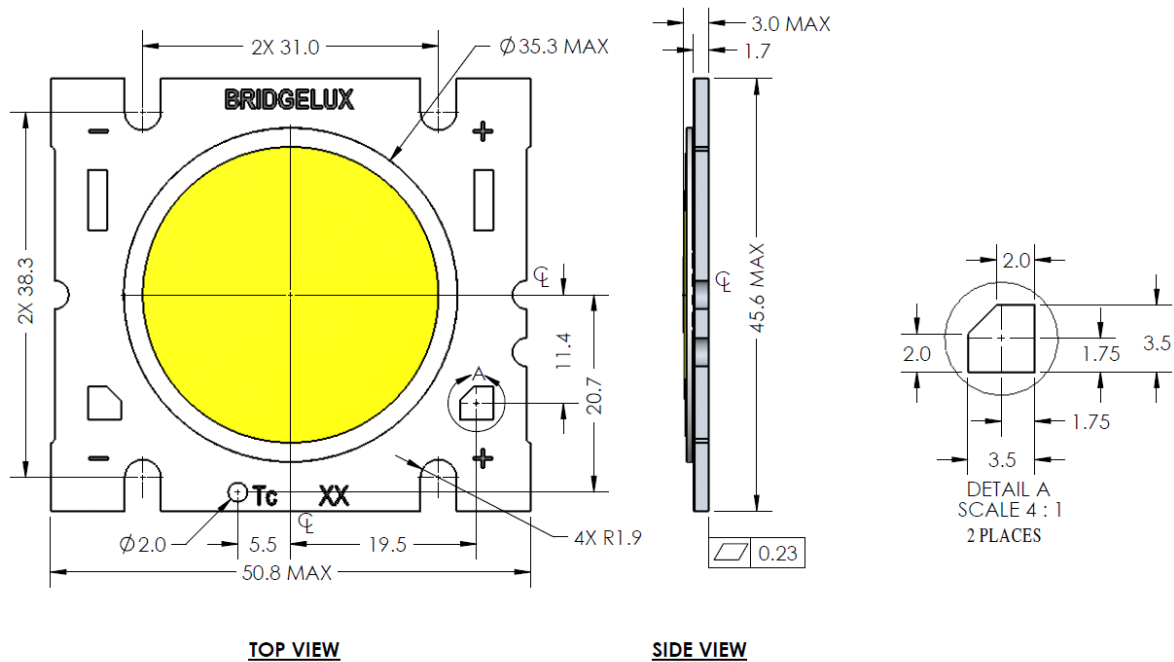

Notes for Figure 14:

1. Slots are for M2.5, M3 or #4 screws.
2. Solder pads are labeled "+" and "-" to denote positive and negative, respectively.
3. It is not necessary to provide electrical connections to both sets of solder pads. Either set of solder pads (6.35 x 2.03 mm rectangular pads or 3.50 mm tapered square pads) may be used depending on application specific design requirements.
4. Drawings are not to scale.
5. Drawing dimensions are in millimeters.
6. Unless otherwise specified, tolerances are ± 0.10 mm.
7. Refer to product Application Notes AN10 and AN11 for product handling, mounting and heat sink recommendations.
8. The optical center of the LED Array is nominally defined by the mechanical center of the array. The light emitting surface (LES) is centered on the mechanical center of the array to a tolerance of ± 0.45 mm.
9. Bridgelux maintains a flatness of 0.25 mm across the mounting surface of the array. Refer to Application Notes AN10 and AN11 for product handling, mounting and heat sink recommendations.
10. Bridgelux recommends four tapped holes for mounting screws – refer to product Application Note AN11 for recommended spacing of holes.

Color Binning Information

Figure 15: Graph of Warm White Test Bins in xy Color Space

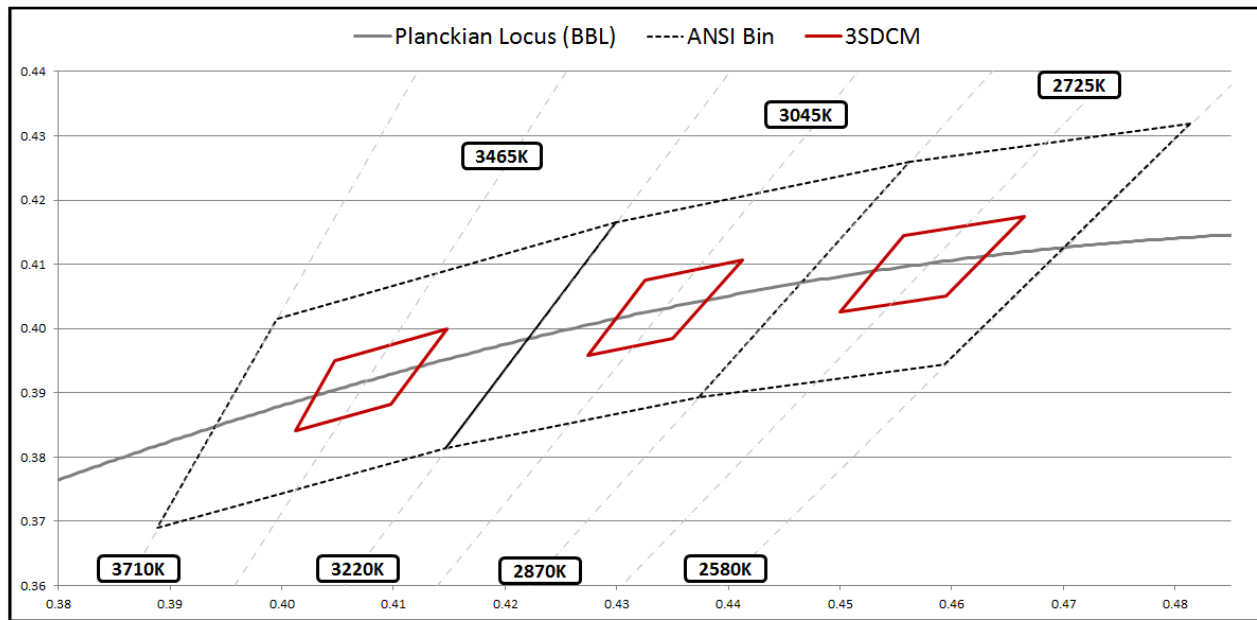

Note: 3SDCM bins are shown inside standard ANSI bins for comparison purposes.

Table 7: Warm White xy Bin Coordinates and Associated Typical CCT

Bin Code	x	y	CCT (K)
X3 (3SDCM)	0.4148	0.4000	3500
	0.4047	0.3950	
	0.4012	0.3841	
	0.4098	0.3883	
	0.4148	0.4000	

Bin Code	x	y	CCT (K)
X3 (3SDCM)	0.4413	0.4107	3000
	0.4325	0.4075	
	0.4274	0.3958	
	0.4350	0.3984	
	0.4413	0.4107	

Bin Code	x	y	CCT (K)
X3 (3SDCM)	0.4665	0.4175	2700
	0.4557	0.4145	
	0.4500	0.4026	
	0.4595	0.4050	
	0.4665	0.4175	

Color Binning Information (continued)

Figure 16: Graph of Neutral White Test Bins in xy Color Space

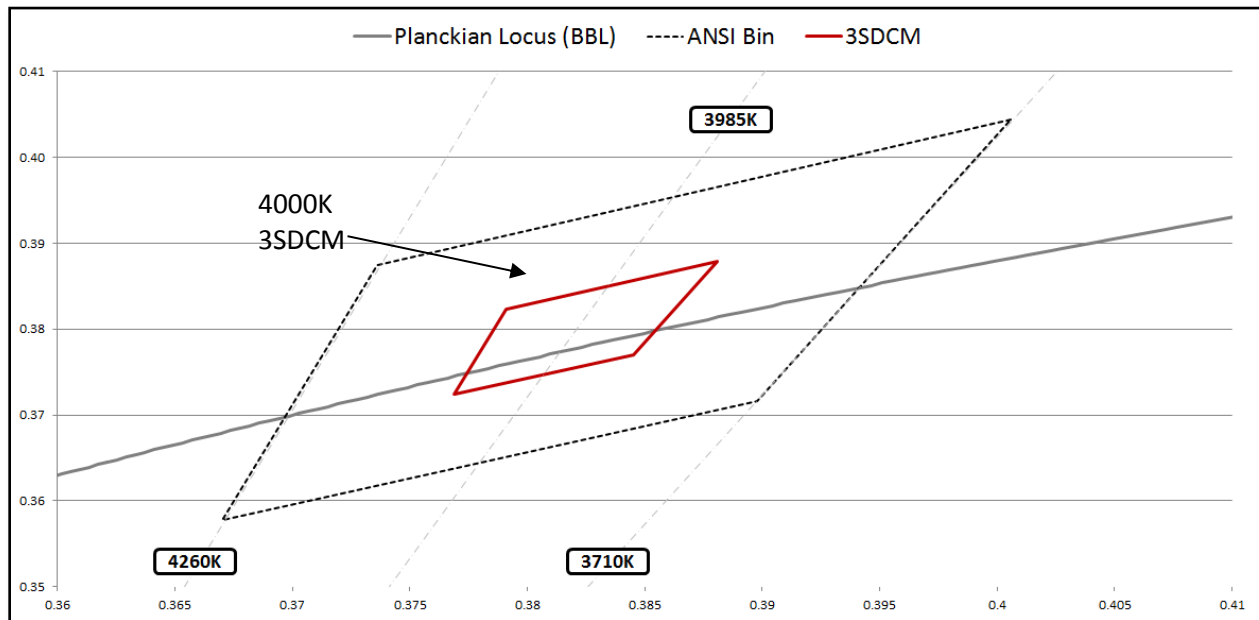

Note: 3SDCM bins are shown inside standard ANSI bins for comparison purposes.

Table 8: Neutral White xy Bin Coordinates and Associated Typical CCT

Bin Code	X	Y	CCT (K)
X3 3SDCM	0.3881	0.3879	4000
	0.3791	0.3823	
	0.3769	0.3724	
	0.3845	0.377	

Color Binning Information (continued)

Figure 17: Graph of Cool White Test Bins in xy Color Space

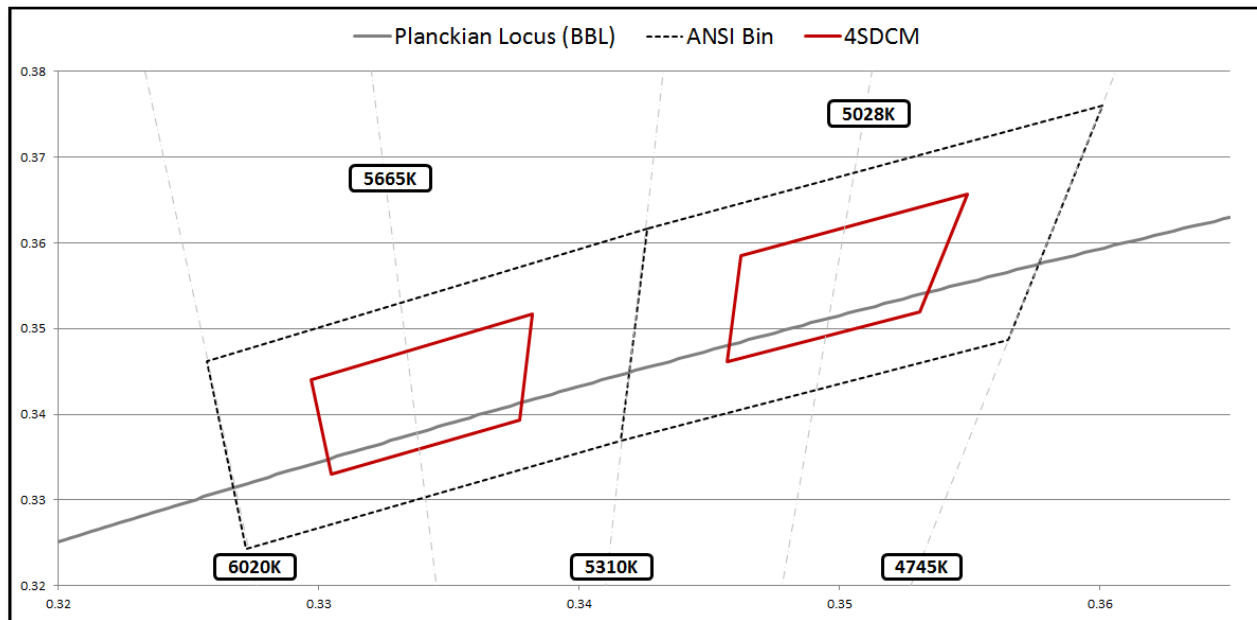

Note: 4SDCM bins are shown inside standard ANSI bins for comparison purposes.

Table 9: Cool White xy Bin Coordinates and Associated Typical CCT

Bin Code	X	Y	ANSI CCT (K)	Bin Code	X	Y	ANSI CCT (K)
G3	0.3376	0.3616	5000	E3	0.3215	0.3353	5600
	0.3464	0.3688			0.3293	0.3423	
	0.3452	0.3558			0.3292	0.3539	
	0.3371	0.3493			0.3207	0.3462	
G4	0.3371	0.3493	5000	E4	0.3222	0.3243	5600
	0.3452	0.3558			0.3294	0.3306	
	0.3441	0.3428			0.3293	0.3423	
	0.3366	0.3369			0.3215	0.3353	
H3	0.3464	0.3688	5000	F3	0.3292	0.3539	5600
	0.3551	0.376			0.3293	0.3423	
	0.3533	0.3624			0.3371	0.3493	
	0.3452	0.3558			0.3376	0.3616	
H4	0.3452	0.3558	5000	F4	0.3294	0.3306	5600
	0.3533	0.3624			0.3366	0.3369	
	0.3515	0.3487			0.3371	0.3493	
	0.3441	0.3428			0.3293	0.3423	
X4 (4SDCM)	0.3499	0.3657	5000	X4 (4SDCM)	0.3332	0.3517	5600
	0.3412	0.3585			0.3247	0.3440	
	0.3407	0.3461			0.3255	0.3330	
	0.3481	0.3520			0.3327	0.3393	

Color Control Options

RS LED Series Arrays are available in the following color control options.

Table 10: Color Control Options

Product	CCT	CRI	3SDCM Part Number	4SDCM Part Number	7SDCM Part Number
RS LED Array	2700K	80	BXRA-27E3500-F-03	Not available	Not available
RS LED Array	2700K	90	BXRA-27G3500-F-03	Not available	Not available
RS LED Array	2700K	80	BXRA-27E4000-H-03	Not available	Not available
RS LED Array	2700K	90	BXRA-27G4000-H-03	Not available	Not available
RS LED Array	2700K	80	BXRA-27E7000-J-03	Not available	Not available
RS LED Array	2700K	90	BXRA-27G7000-J-03	Not available	Not available
RS LED Array	3000K	80	BXRA-30E3500-F-03	Not available	Not available
RS LED Array	3000K	90	BXRA-30G3500-F-03	Not available	Not available
RS LED Array	3000K	80	BXRA-30E4000-H-03	Not available	Not available
RS LED Array	3000K	90	BXRA-30G4000-H-03	Not available	Not available
RS LED Array	3000K	80	BXRA-30E7000-J-03	Not available	Not available
RS LED Array	3000K	90	BXRA-30G7000-J-03	Not available	Not available
RS LED Array	3500K	80	BXRA-35E3500-F-03	Not available	Not available
RS LED Array	3500K	80	BXRA-35E4000-H-03	Not available	Not available
RS LED Array	3500K	80	BXRA-35E7000-J-03	Not available	Not available
RS LED Array	4000K	80	BXRA-40E4000-F-03	Not available	Not available
RS LED Array	4000K	80	BXRA-40E4500-H-03	Not available	Not available
RS LED Array	4000K	80	BXRA-40E7500-J-03	Not available	Not available
RS LED Array	5000K	70	Not available	BXRA-50C4500-F-04	BXRA-50C4500-F-00
RS LED Array	5000K	70	Not available	BXRA-50C5300-H-04	BXRA-50C5300-H-00
RS LED Array	5000K	70	Not available	BXRA-50C9000-J-04	BXRA-50C9000-J-00
RS LED Array	5600K	70	Not available	BXRA-56C4500-F-04	BXRA-56C4500-F-00
RS LED Array	5600K	70	Not available	BXRA-56C5300-H-04	BXRA-56C5300-H-00
RS LED Array	5600K	70	Not available	BXRA-56C9000-J-04	BXRA-56C9000-J-00

Note: Color Control Marking

Array part numbers are shown in the tables above. Arrays are tested, binned and marked with the appropriate sub-bin.

Warm and Neutral White arrays are tested to 3SDCM (marked as X3).

Cool white arrays are tested to 4SDCM (marked as X4).

Cool white arrays are tested to 7SDCM (marked with sub-bin).

Design Resources

Bridgelux has developed a comprehensive set of application notes and design resources to assist customers in successfully designing with Bridgelux LED Array products. Included below is a list of available resources which can be downloaded from the Bridgelux web site under the Design Resources section. These documents are updated regularly as new information becomes available, including complimentary infrastructure products such as commercially available secondary optics and electronic driver solutions.

Application Notes

- AN10: Effective Thermal Management of Bridgelux LED Arrays
- AN11: Assembly Considerations for Bridgelux LED Arrays
- AN12: Electrical Drive Considerations for Bridgelux LED Arrays
- AN14: Reliability Data Sheet for Bridgelux LED Arrays
- AN15: Reflow Soldering of Bridgelux LED Arrays
- AN16: Optical Considerations for Bridgelux LED Arrays

Optical Source Models

Optical source models and ray set files are available for all Bridgelux LED Array products, and can be downloaded directly from the Bridgelux web site. The list below contains the formats currently available. If you require a specific format not included in this list, please contact your Bridgelux sales representative for assistance.

- Zemax
- ASAP
- IESNA
- LightTools
- LucidShape
- OPTIS SPEOS
- PHOTOPIA
- TracePro
- Radiant Imaging Source Model

3D CAD Models

Three dimensional CAD models depicting the product outline of all Bridgelux LED Arrays are available in both SAT and STEP formats. These CAD files can be downloaded directly from the Bridgelux web site.

About Bridgelux

Bridgelux is a leading developer and manufacturer of technologies and solutions transforming the \$40 billion global lighting industry into a \$100 billion market opportunity. Based in Livermore, California, Bridgelux is a pioneer in solid-state lighting (SSL), expanding the market for light-emitting diode (LED) technologies by driving down the cost of LED lighting systems. Bridgelux's patented light source technology replaces traditional technologies (such as incandescent, halogen, fluorescent and high intensity discharge lighting) with integrated, solid-state lighting solutions that enable lamp and luminaire manufacturers to provide high performance and energy-efficient white light for the rapidly growing interior and exterior lighting markets, including street lights, commercial lighting and consumer applications. Bridgelux is the only vertically integrated LED manufacturer and developer of solid-state light sources that designs its solutions specifically for the lighting industry.

For more information about the company, please visit www.bridgelux.com



© 2013 Bridgelux, Inc. All rights reserved. Product specifications are subject to change without notice.

X-ON Electronics

Largest Supplier of Electrical and Electronic Components

Click to view similar products for [bridgelux](#) manufacturer:

Other Similar products are found below :

[BXRC-30E1000-C-73](#) [BXRC-30G1000-C-73](#) [BXRC-35G4000-B-73](#) [BXRE-30G2000-C-73](#) [BXRE-40E2000-C-73](#) [BXKE-40G1501-B-23](#)
[BXEM-50C0000-0-000](#) [BXRC-17E10K0-C-74-SE](#) [BXRC-30G10K0-C-72-SE](#) [BXRC-40E2000-B-73](#) [BXRC-56G10K0-D-74](#) [BXRE-](#)
[27E1000-B-73](#) [BXRE-30G4000-B-73](#) [BXRE-40E2000-B-73](#) [BXRE-40E4000-B-73](#) [BXRE-50C2001-B-74](#) [BXRE-50S1001-C-74](#) [BXEN-](#)
[27S-11L-3C-00-0-0](#) [BXEN-27S-11M-3C-00-0-0](#) [BXEN-27S-13H-9C-00-0-0](#) [BXEN-30S-11L-3C-00-0-0](#) [BXEN-30S-11M-3C-00-0-0](#) [BXEN-](#)
[30S-13H-9C-00-0-0](#) [BXEN-35S-11L-3C-00-0-0](#) [BXEN-35S-11M-3C-00-0-0](#) [BXEN-35S-13H-9C-00-0-0](#) [BXEN-40S-11L-3C-00-0-0](#) [BXEN-](#)
[40S-13H-9C-00-0-0](#) [BXEN-50S-11L-3C-00-0-0](#) [BXEN-50S-13H-9C-00-0-0](#) [BXEN-57S-11L-3C-00-0-0](#) [BXEN-57S-13H-9C-00-0-0](#) [BXRE-](#)
[30S1001-B-73](#) [BXRE-57S1001-C-74](#) [BXRE-65S1001-C-74](#) [BXDR-30BT-U214P-01-A](#) [BXDR-60BT-U220P-01-A](#) [BXDR-60LT-U220P-01-](#)
[A](#) [BXRC-30E10K0-D-73-SE](#) [BXKE-27G1501-B-23](#) [BXRV-TR-2765G-30A0-A-23](#) [BXRC-35E4000-F-23](#) [BXRC-30E1000-B-23](#) [BXRC-](#)
[30E1000-D-73-SE](#) [BXRC-27G2000-C-23](#) [BXRC-27H1000-C-73](#) [BXRH-30E0600-A-73](#) [BXKE-27G0801-A-23](#) [BXKE-30G0801-A-23](#)
[BXKE-40G0801-A-23](#)