

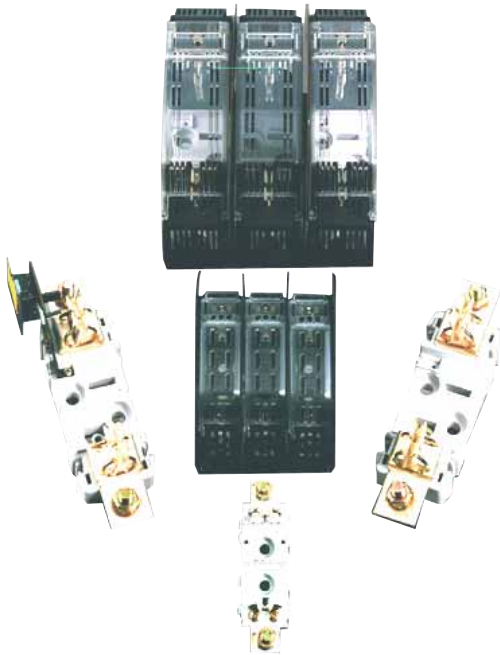

Gears & Fuse Gears

IEC General Purpose Fuses NH Fuses Plastic Bases



00-EP/TP

NH fuse bases are designed for fuse-links with rated voltages up to 690 VAC and 440 VDC. They are in compliance with IEC 60269, DIN VDE 0636, part 21, 201 and DIN 43620 (dimensions).

NH fuse bases are available for delivery in single-pole and three-pole designs and can be closely mounted in parallel rows. Each three-pole base is supplied with two phase-partition walls. NH-ISO plug-on covers which clip onto the contact springs can also be supplied for these bases.

Ceramic fuse bases in sizes 00 to 3 are provided with a single-part steatite base, while size 4 has a metal baseplate with 2 ceramic bases. Plastic fuse bases have a single-part plastic base.

The stable silver-plated contact springs are made of electrolytic copper and formed from one piece. Separate springing is provided by highly resilient captive steel springs, making the contact invulnerable to high thermal stress.

Size 4 NH fuse bases are designed for size 4 fuse-links with 8 mm contact blades.
Size 4a fuse bases are designed for size 4a fuse-links with 6 mm contact blades.

690V Polyester fuse bases for NH fuse-links

- Polyester insulating bases
- Silver-plated contacts
- High-pressure spring contacts (see picture)
- Screw or rail mount



Type EP



Type PP

Connection Detail

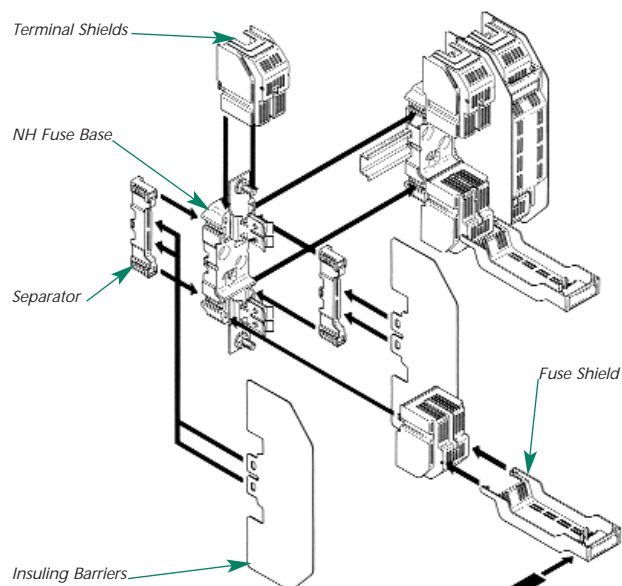

Typical NH Polyester Fuse Base Assembly - Exploded View



IEC General Purpose Fuses NH Fuses Plastic Bases

00-EP/TP

Characteristics

- Thermoplastic base highly temperature resistant and self-extinguishable
- Silver-plated contacts with high-contact pressure springs
- Multipolar bases possible by direct linkage in 00 size and with separator accessory in sizes 0, 1, 2 and 3
- Variety of options for protecting active parts through use of accessories: separating plates, separator, cover shields and fuse cover
- Dual cable-connection system on 00 size: by screw or clamp
- Connecting cable: 50 mm
- Fixation on rail or by screw

Type 00-EP* - Fuse bases for NH-00 Fuse-links - Power acceptance: 12W

Poles	Previous Ref.				Ref. Number				Cat. Number				Pack.
	Screw Connector		Clamp Connector		Screw Connector		Clamp Connector		Screw Connector		Clamp Connector		
	Screw MT.	Rail MT.	Screw MT.	Rail MT.	Screw MT.	Rail MT.	Screw MT.	Rail MT.	Screw MT.	Rail MT.	Screw MT.	Rail MT.	
1	41002	42002	41102	42102	F215170	R216192	T219805	F200795	NH00BPLSC1PT0	NH00BPLRL1PT0	NH00BPLSC1PT2	NH00BPLRL1PT2	3
2	41012	42012	41112	42112	A217212	F218758	D200793	T211594	BB002EP	EPO02R	EPB002	EPB002R	2
3	41014	42014	41114	42114	W229122	V229121	W201338	C212108	NH00BPLSC3PT0	NH00BPLRL3PT0	EPB003	EPB003R	1
4	41019	42019	41119	42119	S219275	Z223007	R211592	M215682	EP004	EPO04R	EPB004	EPB004R	1

* EP bases have square contacts.



F215170



W229122

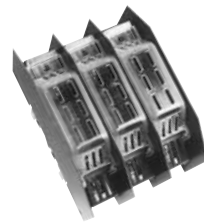

T229120

Type 00-TP - IP20 Fuse bases

Poles	Previous Ref.				Ref. Number				Cat. Number				Pack.
	Screw Connector		Clamp Connector		Screw Connector		Clamp Connector		Screw Connector		Clamp Connector		
	Screw MT.	Rail MT.	Screw MT.	Rail MT.	Screw MT.	Rail MT.	Screw MT.	Rail MT.	Screw MT.	Rail MT.	Screw MT.	Rail MT.	
1	41003	42003	41103	42103	M216694	S218240	X223005	D211074					3
3	41015	42015	41115	42115	T229120	S229119	B211072	J215173					1

Dimensions

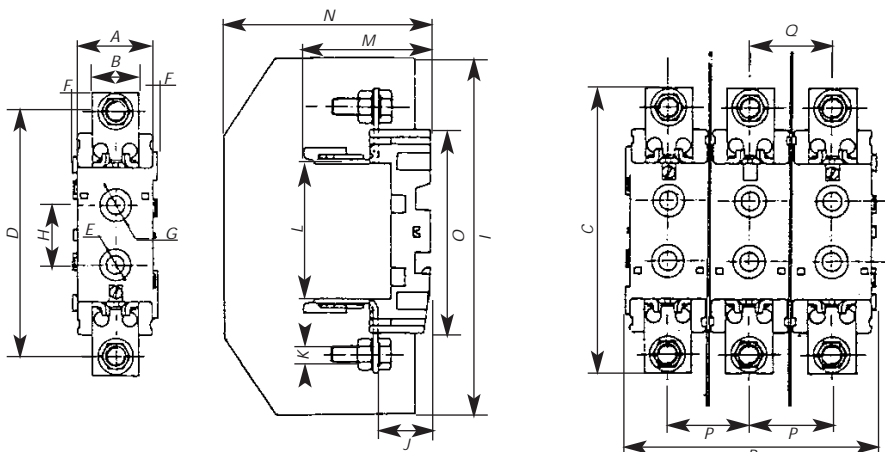

NH 00-E	
A	32
B	20
C	117
D	100
E	8
F	2
G	14
H	25
I	145
J	21,5
K	8
L	56
M	52
N	85
O	84
P	34
Q	1
R	104

Connection

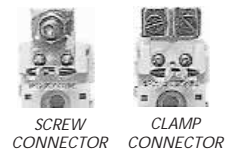

SCREW CONNECTOR CLAMP CONNECTOR



Gears & Fuse Gears

IEC General Purpose Fuses NH Fuses Plastic Bases

O-EP - 0 to 3 PP

Type O-EP* - Fuse Bases for NH-0 Fuse-links - Power acceptance: 25W



S216193

Poles	Previous Ref. Mounting Style		Ref. Num Mounting Style		Cat. Num Mounting Style		Standard Pack
	Screw	Din Rail	Screw	Din Rail	Screw	Din Rail	
1	41202	42202	B213142	S216193	NH0BPLSC1PT0	EP01R	3
2	41212	42212	C214661	P216696	EP02	EP02R	2
3	41214	42214	G215171	C217214	EP03	EP03R	1
4	41219	42219	Q216191	J217726	EP04	EP04R	1

* EP bases have square contacts. PP bases have clips contacts.

Type O-PP - Fuse Bases for NH-0 Fuse-links

1	41302	42302	N216695	T218241	PP01	PP01R	3
2	41312	42312	B217213	G218759	PP02	PP02R	2
3	41314	42314	G217724	W219278	PP03	PP03R	1
4	41319	42319	R218239	H222486	PP04	PP04R	1

Type 1-PP - Fuse Bases for NH-1 Fuse-links - Power acceptance: 32W



F222484

1	41402	42402	E218757	A223008	NH1BPLSC1PT0	PP11R	3
2	41412	42412	F222484	G200796	PP12	PP12R	2
3	41414	42414	Y223006	Y201340	PP13	PP13R	1
4	41419	42419	X201339	H201855	PP14	PP14R	1

Type 2-PP - Fuse Bases for NH-2 Fuse-links - Power acceptance: 45W



B212107

1	41502	42502	F201853	E211075	PP21	PP21R	3
2	41512	42512	S211593	V211595	PP22	PP22R	2
3	41514	42514	B212107	D212109	PP23	PP23R	1
4	41519	42519	C213143	R212627	PP24	PP24R	1

Type 3-PP - Fuse Bases for NH-3 Fuse-links - Power acceptance: 60W



B212107

1	41602	42602	W213643	X213644	NH3BPLSC1PT0	PP31R	3
2	41612	42612	D214662	B214154	PP32	PP32R	2
3	41614	42614	H215172	F214664	PP33	PP33R	1
4	41619	42619	L215681	K215174	PP34	PP34R	1

For NH-4 Fuse Bases, see "5\$" section

Dimensions of Polyester Fuse - Bases for NH Fuse-Links

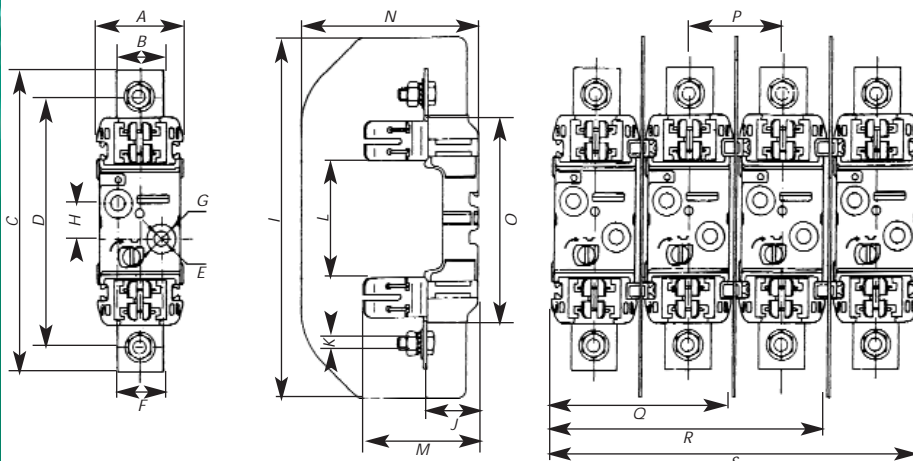

	O-EP	O-PP	1-PP	2-PP	3-PP
A	46	46	60	60	60
B	20	25	32	35	40
C	168	168	209	225	241
D	150.5	150.5	176	201	210
E	7.5	7.5	10.5	10.5	10.5
F	-	-	30	30	30
G	14.5	14.5	20.5	20.5	20.5
H	25	25	25	25	25
I	185	185	250	250	270
J	29	29	35	35	35
K	M8	M8	M10	M10	M12
L	74	75	81	81	81
M	59	61	71	89	103
N	95	95	122.5	122.5	142.5
O	122	122	146	146	146
P	48.5	48.5	65.5	65.5	81.5
Q	94	94	125.5	125.5	141.5
R	142	142	191	191	223
S	190	190	256.5	256.5	304.5



IEC General Purpose Fuses NH Fuses Plastic Bases

Sizes 00 to 3

Insulating Barriers for Polyester NH Fuse Bases

Size	Previous Ref.	Reference Number	Catalog Number	Pack
00	44502	W212654	NH00WALL	2
0	44504	Z213669	NH0WALL	2
1-2	44510	J214690	NH1NH2WALL	2
3	44512	Q215708	NH3WALL	2
D0/3 poles*	84392	B233865		2

* ref number V229121 and W229122 only



W212654

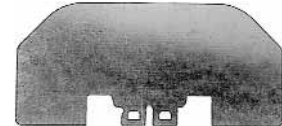

J214690

Separators

0	44604	V216724	NH0CONN	2
1-2	44610	N217753	NH1NH2CONN	2
3	44612	M218787	NH3CONN	2



N217753

Fuse Shields

00	44802	G213170	NH00LUGCV	3
00*		B233566		3
0	44804	F214181		3
0*		D233568		3
1-2	44810	K214691	NH1NH2LUGCV	3
1-2*		E233569		3
3	44812	R215709	NH3LUGCV	3
3*		F233570		3

* for use of microswitch



G213170

Terminal Shields

00	44702	M222513	NH00TERMCV	6
0	44704	K200822	NH0TERMCV	6
1	44708	L201881	NH1TERMCV	6
2	44710	Y211621	NH2TERMCV	6
3	44712	X212655	NH3TERMCV	6



M222513

Complete references for IP2X Fuse Bases (no microswitch possible) Fixation on rail

Size	Pole	Ref. Num.	Cat. Num	Pack
00	1	S218240		3
	3	S229119		1
0	1	G226717	EPO1RIP20	3
	3	J226719	EPO3RIP20	1
1	1	P226724	PP11RIP20	3
	3	Q226725	PP13RIP20	1

Size	Pole	Ref. Num.	Cat. Num	Pack
2	1	R226726	PP21FSR	3
	3	S226727	PP23FSR	1
3	1	T226728	PP31RIP20	3
	3	V226729	PP33RIP20	1

Fixation by screw

Size	Pole	Ref. Num.	Cat. Num	Pack
00	1	M216694		3
	3	T229120		1
0	1	X226708		3
	3	Z226710		1
1	1	V219806	PP1IP20	3
	3	B226712		1

Size	Pole	Ref. Num.	Cat. Num	Pack
2	1	C226713	PP24FS	3
	3	D226714		1
3	1	E226715		3
	3	F226716		1

X-ON Electronics

Largest Supplier of Electrical and Electronic Components

Click to view similar products for [Tactile Switches](#) category:

Click to view products by [Mersen](#) manufacturer:

Other Similar products are found below :

[KMR633NG LFG](#) [5GTH92001](#) [5GTH9202242](#) [6426-201-11343](#) [MJ1226](#) [MJTP1109B](#) [MJTP1138EAUTR](#) [MJTP1230BL](#) [MJTPSHW](#)
[GS6.90F300QP](#) [1-1977223-0](#) [1-1977120-4](#) [ADTSA62NV](#) [ADTSA62RV](#) [ADTSA63KV](#) [ADTSA644NV](#) [ADTSM24NVTR](#) [ADTSMW66NV](#)
[ADTSMW67RV](#) [ATM533VTR](#) [1571300-3](#) [B3F-3123](#) [B3F-6055A](#) [B3F-B32-01-KIT](#) [1977177-8](#) [1977266-1](#) [2-1977223-4](#) [2-1977223-7](#)
[ADTS644KV](#) [ADTSA61RV](#) [ADTSA62KV](#) [ADTSA63NV](#) [ADTSA63RV](#) [ADTSA65NV](#) [ADTSM21NSVTR](#) [ADTSM25RVTR](#)
[ADTSM31RVTR](#) [ADTSM32NVTR](#) [ADTSM61YVTR](#) [ADTSM63SVTR](#) [ADTSM644KVTR](#) [ADTSMW64RV](#) [ADTSMW69NV](#)
[FSMRA4JHA04](#) [GS4.70F300QP](#) [D38999/20JJ37SA](#) [TL1105B](#) [TL1105J](#) [ATH447K2Q](#) [ATM534VTR](#)