

SANMOTION

New Product Information

2-phase Stepping Motor 60mm square 0.9°

SANYO DENKI EUROPE SA. is pleased to introduce their 2-phase, 60mm square 0.9° per step stepping motor «**SANMOTION F2 - SH16**».

This serie of stepping motor has a high resolution, a compact size, and a high torque and can contribute to higher precision, lower costs, and more compact sizes industrial equipments.

Specifications :

Square flange : 60 mm (NEMA 23)

Holding torque : 0.69 to 2.15 Nm

Current per phase : 2 Amps

Connection : Unipolar and Bipolar with lead wire output

3 lengths of motor are available 42, 54 and 76 mm in single or double shaft version to meet the requirements of your application.

Main features :

1) High Torque :

With an optimum magnetic circuit design, the torque was improved from the conventional 0.9° stepping motor. Furthermore, with a **NEMA Size 23 mounting**, the SH16 motors (60mm) can easily replace any size 23 (56mm) motors delivering more torque, and are suitable for more powerful and faster machines.

2) High Resolution and Precision :

The improved die precision and the double number of teeth of the rotor and stator enable a high resolution with 0.9° per step (400 steps per revolution) and a high accuracy of $\pm 0.054^\circ$.

3) Low Vibration and Low Noise :

The high-level concentricity of the rotor and stator enable better rotational balance for lower vibrations and lower noise. Additionally, thanks to smaller step angles, 0.9° stepping motors have much less vibrations than in 1.8° stepping motor.

4) Compact Size for Less Space :

A new "lead wire holder system" enable to eliminate the protrusion of the lead wire outlet without sacrificing motor characteristics.

Furthermore, this serie is RoHS compliant, ensuring a small environmental footprint and has received Sanyo Denki's environmental design certification "**ECO PRODUCTS**".

Target Applications :

Medical instruments, OA automation and semiconductor manufacturing equipments.

For further information on Sanyo Denki «**SANMOTION F2 - SH16**», please contact us at **+33 1 48 63 26 61** or email us at **info@sanyodenki.eu**.



2-phase stepping motor

60mm sq.(2.36inch sq.)SH160
0.9 °/step

Unipolar winding • Lead wire type

Model		Holding torque at 2-phase energization [N · m (oz · in) MIN.]	Rated current A/phase	Wiring resistance /phase	Winding inductance mH/phase	Rotor inertia [$\times 10^{-4}$ kg · m ² (oz · in ²)]	Mass (Weight) [kg(lbs)]
Single shaft	Double shafts						
SH1601-0440	-0410	0.57 (80.71)	2	1.35	2	0.24 (1.312)	0.55 (1.21)
SH1602-0440	-0410	1.1 (155.77)	2	1.8	3.5	0.4 (2.187)	0.8 (1.76)
SH1603-0440	-0410	1.7 (240.74)	2	2.3	4.5	0.75 (4.101)	1.2 (2.64)

Pulse rate-torque characteristics

SH1601-04

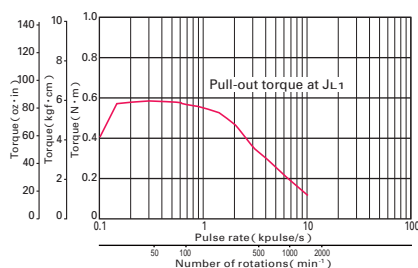

Constant current circuit
Source voltage : DC24V · operating current : 2A/phase,
2-phase energization (full-step)
 $J_{L1} = [0.94 \times 10^{-4} \text{kg} \cdot \text{m}^2 (5.14 \text{oz} \cdot \text{in}^2)$ use the rubber coupling]

SH1602-04

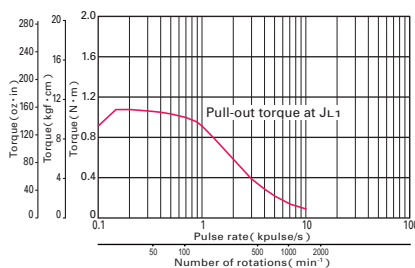

Constant current circuit
Source voltage : DC24V · operating current : 2A/phase,
2-phase energization (full-step)
 $J_{L1} = [2.6 \times 10^{-4} \text{kg} \cdot \text{m}^2 (14.22 \text{oz} \cdot \text{in}^2)$ use the rubber coupling]

SH1603-04

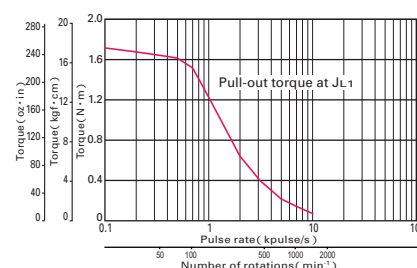

Constant current circuit
Source voltage : DC24V · operating current : 2A/phase,
2-phase energization (full-step)
 $J_{L1} = [7.4 \times 10^{-4} \text{kg} \cdot \text{m}^2 (40.46 \text{oz} \cdot \text{in}^2)$ use the rubber coupling]

The data are measured under the drive condition of our company. The drive torque may vary depending on the accuracy of customer-side equipment.

Bipolar winding • Lead wire type

Model		Holding torque at 2-phase energization [N · m (oz · in) MIN.]	Rated current A/phase	Wiring resistance /phase	Winding inductance mH/phase	Rotor inertia [$\times 10^{-4}$ kg · m ² (oz · in ²)]	Mass (Weight) [kg(lbs)]
Single shaft	Double shafts						
SH1601-5240	-5210	0.69 (97.7)	2	1.2	3.5	0.24 (1.31)	0.55 (1.21)
SH1602-5240	-5210	1.28 (181.2)	2	1.65	6.1	0.4 (2.19)	0.8 (1.76)
SH1603-5240	-5210	2.15 (304.4)	2	2.3	8.8	0.75 (4.10)	1.2 (2.65)

Pulse rate-torque characteristics

SH1601-52

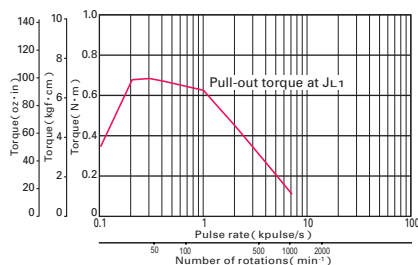

Constant current circuit
Source voltage : DC24V · operating current : 2A/phase,
2-phase energization (full-step)
 $J_{L1} = [0.94 \times 10^{-4} \text{kg} \cdot \text{m}^2 (5.14 \text{oz} \cdot \text{in}^2)$ use the rubber coupling]

SH1602-52

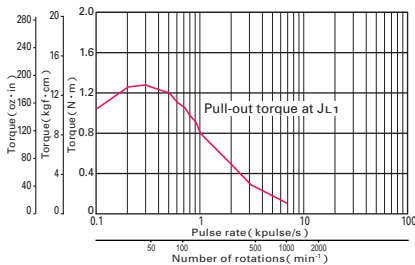

Constant current circuit
Source voltage : DC24V · operating current : 2A/phase,
2-phase energization (full-step)
 $J_{L2} = [2.6 \times 10^{-4} \text{kg} \cdot \text{m}^2 (14.22 \text{oz} \cdot \text{in}^2)$ use the rubber coupling]

SH1603-52

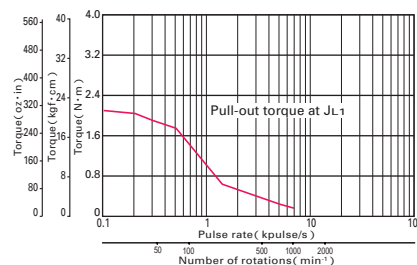

Constant current circuit
Source voltage : DC24V · operating current : 2A/phase,
2-phase energization (full-step)
 $J_{L3} = [7.4 \times 10^{-4} \text{kg} \cdot \text{m}^2 (40.46 \text{oz} \cdot \text{in}^2)$ use the rubber coupling]

The data are measured under the drive condition of our company. The drive torque may vary depending on the accuracy of customer-side equipment.

Motors [Unit: mm (inch)]

56mm (2.20inch)

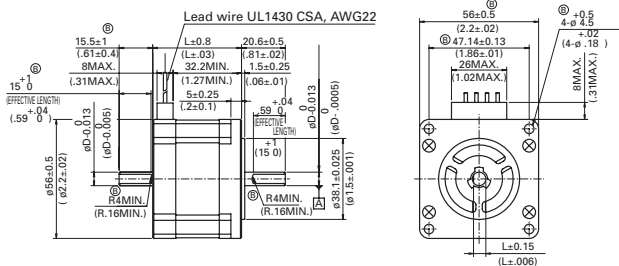

Lead wire type

	Set part number	Motor model number	Motor length : mm (inch)	Cable type
Bipolar	DB16H711	103H7121-57 0	41.8 (1.65)	Lead wire
	DB16H713	103H7123-57 0	53.8 (2.12)	Lead wire
	DB16H716	103H7126-57 0	75.8 (2.98)	Lead wire
	—	103H7121-56 0	41.8 (1.65)	Lead wire
	—	103H7121-58 0	41.8 (1.65)	Lead wire
	—	103H7123-56 0	53.8 (2.12)	Lead wire
	—	103H7123-58 0	53.8 (2.12)	Lead wire
	—	103H7126-56 0	75.8 (2.98)	Lead wire
	—	103H7126-58 0	75.8 (2.98)	Lead wire
	—	103H7128-56 0	94.8 (3.73)	Lead wire
—	103H7128-57 0	94.8 (3.73)	Lead wire	
—	103H7128-58 0	94.8 (3.73)	Lead wire	

60mm (2.36inch)

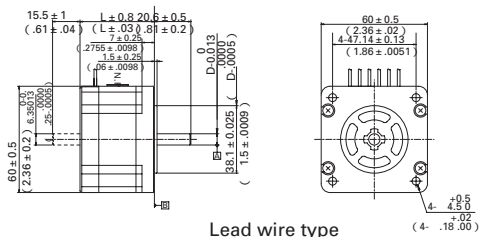

	Set part number	Motor model number	Motor length : mm (inch)	Cable type
Unipolar	—	SH1601-04 0	42 (1.65)	Lead wire
	—	SH1602-04 0	54 (2.13)	Lead wire
	—	SH1603-04 0	76 (2.99)	Lead wire
Bipolar	DB16S161	SH1601-52 0	42 (1.65)	Lead wire
	DB16S162	SH1602-52 0	54 (2.13)	Lead wire
	DB16S163	SH1603-52 0	76 (2.99)	Lead wire

60mm (2.36inch)

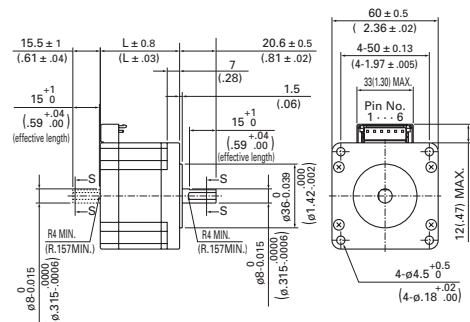

Connector type

	Set part number	Motor model number	Motor length : mm (inch)	Cable type
Unipolar	—	103H7821-01 0	44.8 (1.76)	Connector
	—	103H7821-04 0	44.8 (1.76)	Connector
	—	103H7821-07 0	44.8 (1.76)	Connector
	—	103H7822-01 0	53.8 (2.12)	Connector
	—	103H7822-04 0	53.8 (2.12)	Connector
	—	103H7822-07 0	53.8 (2.12)	Connector
	—	103H7823-01 0	85.8 (3.38)	Connector
	—	103H7823-04 0	85.8 (3.38)	Connector
Bipolar	DB16H781	103H7821-57 0	44.8 (1.76)	Connector
	DB16H782	103H7822-57 0	53.8 (2.12)	Connector
	DB16H783	103H7823-57 0	85.8 (3.38)	Connector
	—	103H7821-17 0	44.8 (1.76)	Connector
	—	103H7822-17 0	53.8 (2.12)	Connector
—	103H7823-17 0	85.8 (3.38)	Connector	

86mm (3.39inch)

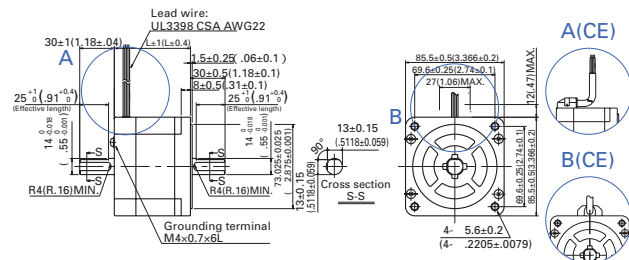

Lead wire type

CE type

	Set part number	Motor model number	Motor length : mm (inch)	Cable type
Unipolar	—	SH2861-04 1	66 (2.6)	Lead wire
	—	SH2862-04 1	96.5 (3.8)	Lead wire
	—	SH2863-04 1	127 (5)	Lead wire
Bipolar	—	SM2861-50 1	66 (2.6)	Lead wire (CE)
	—	SM2861-51 1	66 (2.6)	Lead wire (CE)
	—	SM2861-52 1	66 (2.6)	Lead wire (CE)
	—	SM2862-50 1	96.5 (3.8)	Lead wire (CE)
	—	SM2862-51 1	96.5 (3.8)	Lead wire (CE)
	—	SM2862-52 1	96.5 (3.8)	Lead wire (CE)
	—	SM2863-50 1	127 (5)	Lead wire (CE)
—	SM2863-51 1	127 (5)	Lead wire (CE)	
—	SM2863-52 1	127 (5)	Lead wire (CE)	

Model number	Shaft diameter(D)	Deut thickness(L)
103H7121-	6.35	5.8
103H7123-		
103H7126-		
103H7128-	8	7.5
Model number	Shaft diameter(D)	Deut thickness(L)
SH1601-	6.35	5.8
SH1602-		
SH1603-		
SH1603-	8	7.5

: Motor shaft specification code

Motor shaft spec	Set type code	Motor type code
Single shaft	S	4
Double shafts	D	1

: Motor shaft specification code

Motor shaft spec	Set type code	Motor type code
Single shaft	S	5
Double shafts	D	2

X-ON Electronics

Largest Supplier of Electrical and Electronic Components

Click to view similar products for [sanyo denki manufacturer](#):

Other Similar products are found below :

[9A0812G401](#) [9A0824H401](#) [9G0824H102](#) [9GA0812P1H61](#) [9GA0812P1S61](#) [9GL1212F101](#) [9GV1412P1G001](#) [9GV3612G301](#)
[9WG1212H102](#) [9WG1224G101](#) [SM2861-5255](#) [9GT0912P1M001](#) [9GV0312E302](#) [9S1212F4011](#) [9SG5748P5H01](#) [9WG1212E101](#) [489-007-](#)
[L21](#) [103H5208-5240](#) [103H7126-1740](#) [103H7822-5740](#) [109-1001F13](#) [109-1003M30](#) [109-313](#) [109L1748H501](#) [109L5712H501](#)
[109P1412M101](#) [109R0824S4D01](#) [109-1069](#) [109BF24HD2](#) [9L0412H301](#) [9GA0812P1S61P](#) [9G1212P4G03](#) [9G0612P1G03](#)
[9CRB0812P8G001](#) [103H8221-5141](#) [103H8223-6340](#) [9LG1248P1H001](#) [SH1603-5240](#) [9GA0812P1H611](#) [9BD12SC6-1](#) [109P0824H701](#) [109-](#)
[049C](#) [103H7123-5740](#) [9AH0912P4H03](#) [9G1224G1D01](#) [9GV1212P4G011](#) [9G1224M4D011](#) [9GV0824P1G03](#) [109P0624W602](#)
[9WF0924S201](#)