

# NF Connectors

		pages
Latch Header (1.27mm)	Right Angle, Solder Dip	54-55
Latch Header (1.27mm)	Straight, Solder Dip	56-57
Latch Header (1.27mm)	Straight, Solder Dip	58-59
Box Header (1.27mm)	Right Angle, Solder Dip	60-61
Box Header (1.27mm)	Straight, Solder Dip	62-63
IDC Connectors (1.27mm)	Transition Header	64-65
IDC Connectors (1.27mm)	IDC Receptacle	66-67
Board to Board Recep. (1.27mm)	Through Hole	68-69

# Latch Header (1.27mm, Right Angle, Solder Dip)

## NFP SERIES

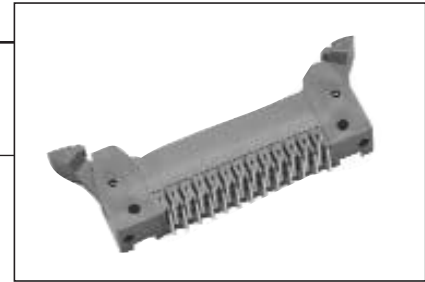

### ORDERING INFORMATION

NFP- \*\*\* A-01 \* 2- \* -\*\*

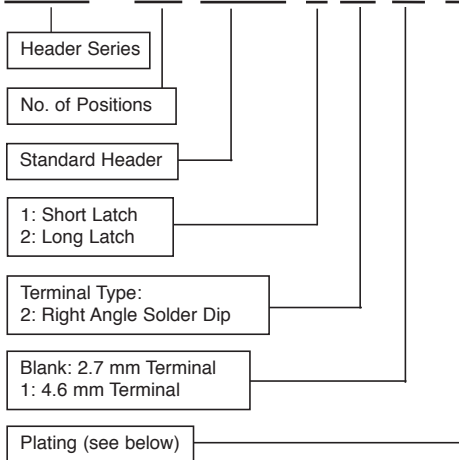

### Characteristics

Current Rating:	0.5A
Insulation Resistance:	1,000M   Minimum at 500 VDC
Withstanding Voltage:	500 VAC for 1 minute
Contact Resistance:	15m   Max. at 10mA
Operating Temperature:	-20°C ~ +85°C

### Material and Finish

Insulator:	High Temp Thermoplastic-UL94V-0
Contact:	Copper Alloy
Plating:	Mating Face Contacts: Au over Ni Terminals: Au or SnPb over Ni

### Features

1. Right-angle terminals
2. Short or long latches
3. Long terminal available
4. Variety of plating options
5. Latches eject receptacle
6. Central polarizing key

### TYPES OF PLATING

Plating Type	Under Plate	Mating Face	Terminals
AS	Ni 2.5 ~ 4.5 μm	Au 0.76μm Min.	SnPb 2.0 ~ 4.0μm
BS	Ni 2.5 ~ 4.5 μm	Au 0.30μm Min.	SnPb 2.0 ~ 4.0μm
AF	Ni 2.5 ~ 4.5 μm	Au 0.76μm Min.	Au 0.05μm Min.
BF	Ni 2.5 ~ 4.5 μm	Au 0.30μm Min.	Au 0.05μm Min.

### CONNECTOR DIMENSIONS (reference only)

Part Number (□, †)	No. of Positions	Pitch	A	B	C	D	E	F	G	H
NFP-10A-01*2-**	10	1.27mm	24.26	5.08	11.58	15.08	38.20	40.20	17.20	8.30
NFP-16A-01*2-**	16	1.27mm	28.09	8.89	15.39	18.89	42.00	44.00	17.20	8.30
NFP-20A-01*2-**	20	1.27mm	30.63	11.43	17.93	21.43	44.60	46.60	17.20	8.30
NFP-26A-01*2-**	26	1.27mm	34.44	15.24	21.74	25.24	48.40	50.40	17.20	8.30
NFP-34A-01*2-**	34	1.27mm	39.52	20.32	26.82	30.32	53.50	55.50	17.20	8.30
NFP-40A-01*2-*.**	40	1.27mm	43.33	24.13	30.63	34.13	57.30	59.30	17.20	8.30
NFP-50A-01*2-*.**	50	1.27mm	49.68	30.48	36.98	40.48	63.60	65.60	17.20	8.30
NFP-60A-01*2-*.**	60	1.27mm	56.03	36.83	43.33	46.83	70.00	72.00	17.20	8.30
NFP-64A-01*2-*.**	64	1.27mm	58.57	39.37	45.87	49.37	72.50	74.50	17.20	8.30
NFP-80A-01*2-*.**	80	1.27mm	68.73	49.53	56.03	59.53	82.70	84.70	17.20	8.30
NFP-100A-01*2-*.**	100	1.27mm	81.43	62.23	68.73	72.23	95.40	97.40	17.20	8.30

- Short Latch  
Positions 50, 60, 64, 80, 100 available in long terminals
- † Long Latch  
Positions 40, 64, 80, 100 available in long terminals

## NFP SERIES

### APPLICABLE DIMENSIONS *(reference only)*

#### Connector Outline Dimensions

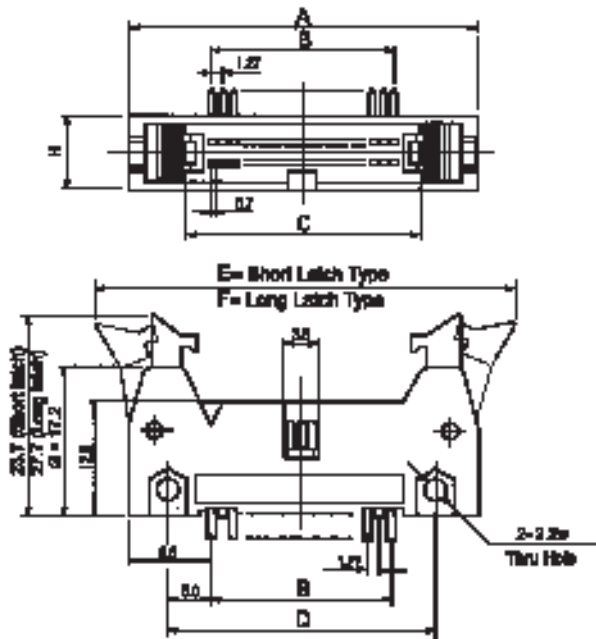

#### Contact Detail

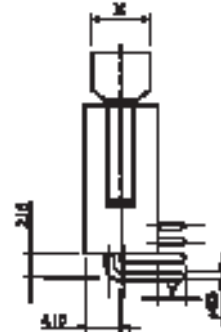

X = 6.5 (Short latch type)  
 4.0 (Long latch type)

Y = 2.7 (Short terminal length)  
 4.6 (Long terminal length)

#### PCB Layout

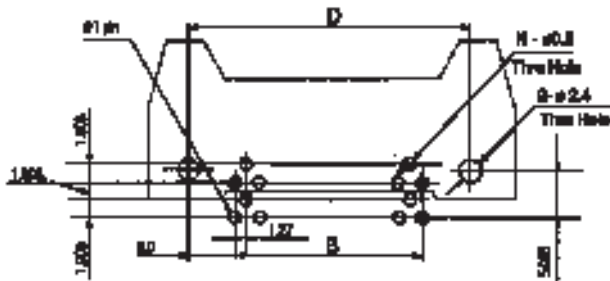

Section A

Section B

10, 26, 34, 50 Contacts

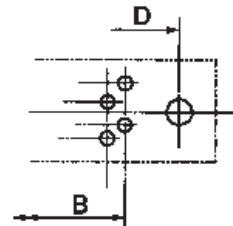

Note: Left half of this PCB layout is identical to Section A

16, 20, 40, 60, 64, 80, 100 Contacts

# Latch Header (1.27mm, Straight, Solder Dip)

## NFP SERIES

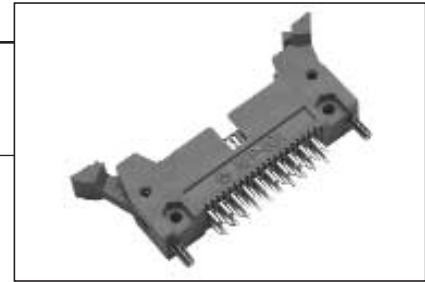

### ORDERING INFORMATION

NFP- \*\*\* A-01 \* 4- \* -\*\*

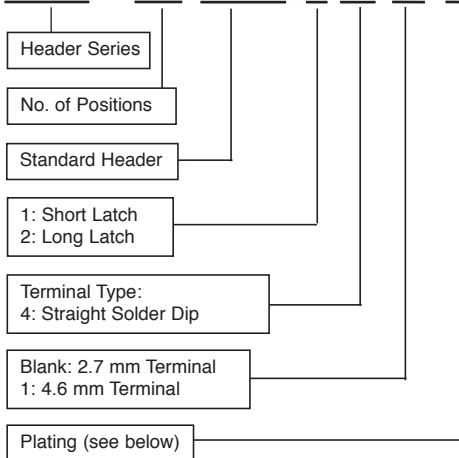

### Characteristics

Current Rating:	0.5A
Insulation Resistance:	1,000M   Minimum at 500 VDC
Withstanding Voltage:	500 VAC for 1 minute
Contact Resistance:	15m   Max. at 10mA
Operating Temperature:	-20°C ~ +85°C

### Material and Finish

Insulator:	High Temp Thermoplastic-UL94V-0
Contact:	Copper Alloy
Plating:	Mating Face Contacts: Au over Ni Terminals: Au or SnPb over Ni

### Features

1. Straight terminals
2. Short or long latches
3. Long terminal available
4. Variety of plating options
5. Spring pin for secure mount
6. Latches eject receptacle
7. Central polarizing key

### TYPES OF PLATING

Plating Type	Under Plate	Mating Face	Terminals
AS	Ni 2.5 ~ 4.5 μm	Au 0.76μm Min.	SnPb 2.0 ~ 4.0μm
BS	Ni 2.5 ~ 4.5 μm	Au 0.30μm Min.	SnPb 2.0 ~ 4.0μm
AF	Ni 2.5 ~ 4.5 μm	Au 0.76μm Min.	Au 0.05μm Min.
BF	Ni 2.5 ~ 4.5 μm	Au 0.30μm Min.	Au 0.05μm Min.

### CONNECTOR DIMENSIONS (reference only)

Part Number (□, †)	No. of Positions	Pitch	A	B	C	D	E	F	G	H
NFP-10A-01*4-□	10	1.27mm	24.28	5.08	11.58	15.08	38.20	40.20	17.20	8.30
NFP-18A-01*4-□	18	1.27mm	28.09	8.89	15.39	18.89	42.00	44.00	17.20	8.30
NFP-20A-01*4-□	20	1.27mm	30.63	11.43	17.93	21.43	44.80	46.80	17.20	8.30
NFP-28A-01*4-□	28	1.27mm	34.44	15.24	21.74	25.24	48.40	50.40	17.20	8.30
NFP-34A-01*4-□	34	1.27mm	39.52	20.32	26.82	30.32	53.50	55.50	17.20	8.30
NFP-40A-01*4-□	40	1.27mm	43.33	24.13	30.63	34.13	57.30	59.30	17.20	8.30
NFP-50A-01*4-□	50	1.27mm	49.68	30.48	36.98	40.48	63.60	65.60	17.20	8.30
NFP-60A-01*4-□	60	1.27mm	56.03	36.83	43.33	46.83	70.00	72.00	17.20	8.30
NFP-64A-01*4-□	64	1.27mm	58.57	39.37	45.87	49.37	72.50	74.50	17.20	8.30
NFP-80A-01*4-□	80	1.27mm	68.73	49.53	56.03	59.53	82.70	84.70	17.20	8.30
NFP-100A-01*4-□	100	1.27mm	81.43	62.23	68.73	72.23	95.40	97.40	17.20	8.30

- Short Latch  
Positions 26, 34, 40, 50, 80, 100 available in long terminals
- † Long latch  
Positions 60, 80, 100 available in long terminals



# Latch Header (1.27mm, Straight Solder Dip)

## NFP SERIES

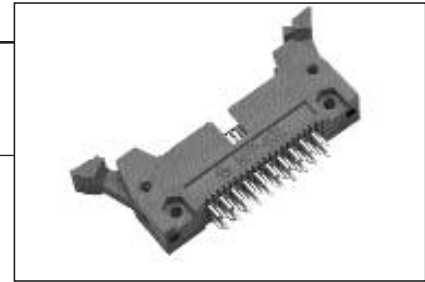

### ORDERING INFORMATION

NFP- \*\*\* A-03 \* 4- \* -\*\*

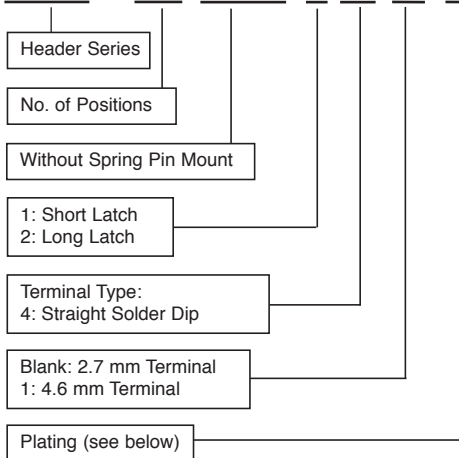

### Characteristics

Current Rating:	0.5A
Insulation Resistance:	1,000M   Minimum at 500 VDC
Withstanding Voltage:	500 VAC for 1 minute
Contact Resistance:	15m   Max. at 10mA
Operating Temperature:	-20°C ~ +85°C

### Material and Finish

Insulator:	High Temp Thermoplastic-UL94V-0
Contact:	Copper Alloy
Plating:	Mating Face Contacts: Au over Ni Terminals: Au or SnPb over Ni

### Features

1. Straight terminals
2. Short or long latches
3. Variety of plating options
4. Long terminal available
5. Latches eject receptacle
6. Central polarizing key

### TYPES OF PLATING

Plating Type	Under Plats	Mating Face	Terminals
AS	Ni 2.5 ~ 4.5 μm	Au 0.76μm Min.	SnPb 2.0 ~ 4.0μm
BS	Ni 2.5 ~ 4.5 μm	Au 0.30μm Min.	SnPb 2.0 ~ 4.0μm
AF	Ni 2.5 ~ 4.5 μm	Au 0.76μm Min.	Au 0.05μm Min.
BF	Ni 2.5 ~ 4.5 μm	Au 0.30μm Min.	Au 0.05μm Min.

### CONNECTOR DIMENSIONS (reference only)

Part Number (□, †)	No. of Positions	Pitch	A	B	C	D	E	F	G
NFP-10A-03*4-□**	10	1.27mm	24.28	5.08	11.58	20.48	38.20	40.20	8.30
NFP-16A-03*4-□**	16	1.27mm	28.09	8.89	16.39	24.29	42.00	44.00	8.30
NFP-20A-03*4-□**	20	1.27mm	30.63	11.43	17.93	26.83	44.60	46.60	8.30
NFP-28A-03*4-□**	28	1.27mm	34.44	15.24	21.74	30.64	48.40	50.40	8.30
NFP-34A-03*4-□**	34	1.27mm	39.52	20.32	26.82	35.72	53.50	55.50	8.30
NFP-40A-03*4-□**	40	1.27mm	43.33	24.13	30.63	39.53	57.30	59.30	8.30
NFP-50A-03*4-□**	50	1.27mm	49.68	30.48	36.98	45.88	63.60	65.60	8.30
NFP-60A-03*4-□**	60	1.27mm	56.03	36.83	43.33	52.23	70.00	72.00	8.30
NFP-64A-03*4-□**	64	1.27mm	58.57	39.37	45.87	54.77	72.50	74.50	8.30
NFP-80A-03*4-□**	80	1.27mm	68.73	49.53	56.03	64.93	82.70	84.70	8.30
NFP-100A-03*4-□**	100	1.27mm	81.43	62.23	68.73	77.83	95.40	97.40	8.30

- Short Latch  
Positions 10, 50, 60, 80, 100 available in long terminals
- † Long Latch  
Positions 60, 80, 100 available in long terminals

## NFP SERIES

**APPLICABLE DIMENSIONS** (reference only)

### Connector Outline Dimensions

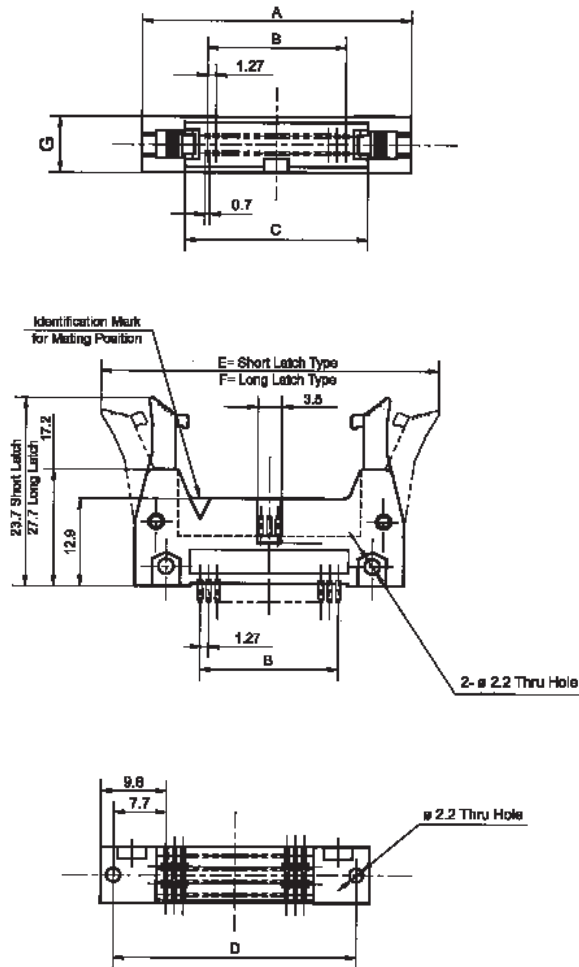

### Contact Detail

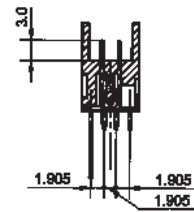

X= 6.5 (Short latch type)  
4.0 (Long latch type)

Y= 2.7 (Short terminal length)  
4.6 (Long terminal length)

### PCB Layout

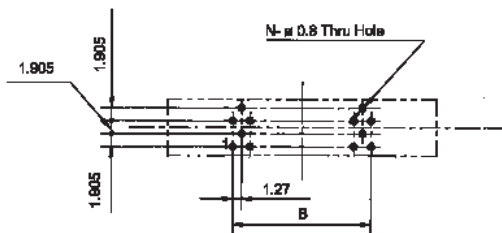

10, 26, 34, 50 Contacts

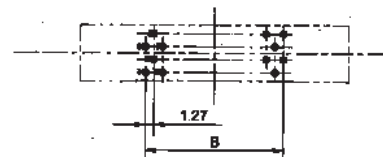

16, 20, 40, 60, 64, 80, 100 Contacts

# Box Header (1.27mm, Right Angle, Solder Dip)

## NFP SERIES

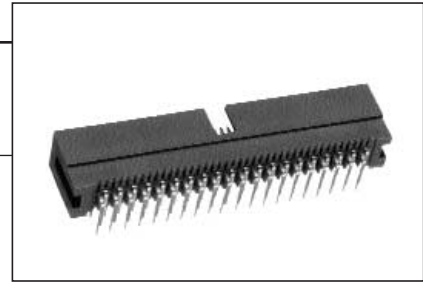

### ORDERING INFORMATION

NFP- \*\* A-013 2- \*\*

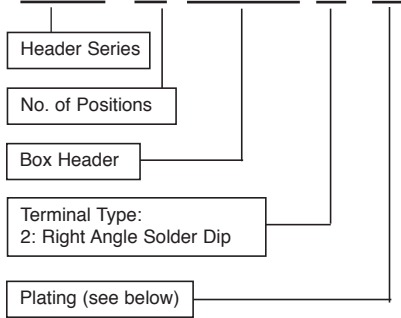

### Characteristics

Current Rating:	0.5A
Insulation Resistance:	1,000M   Minimum at 500 VDC
Withstanding Voltage:	500 VAC for 1 minute
Contact Resistance:	15m   Max. at 10mA
Operating Temperature:	-20°C ~ +85°C

### Material and Finish

Insulator:	High Temp Thermoplastic-UL94V-0
Contact:	Copper Alloy
Plating:	Mating Face Contacts: Au over Ni Terminals: Au or SnPb over Ni

### Features

1. Right-angle terminals
2. Variety of plating options
3. Central polarizing key

### TYPES OF PLATING

Plating Type	Under Plate	Mating Face	Terminals
AS	Ni 2.5 ~ 4.5 μm	Au 0.76μm Min.	SnPb 2.0 ~ 4.0μm
BS	Ni 2.5 ~ 4.5 μm	Au 0.30μm Min.	SnPb 2.0 ~ 4.0μm
AF	Ni 2.5 ~ 4.5 μm	Au 0.76μm Min.	Au 0.05μm Min.
BF	Ni 2.5 ~ 4.5 μm	Au 0.30μm Min.	Au 0.05μm Min.

### CONNECTOR DIMENSIONS (reference only)

Part Number	No. of Positions	Pitch	A	B	C	D
NFP-16A-0132-**	16	1.27mm	17.85	8.89	15.39	8.50
NFP-20A-0132-**	20	1.27mm	20.39	11.43	17.93	8.50
NFP-26A-0132-**	26	1.27mm	24.20	15.24	21.74	8.50
NFP-34A-0132-**	34	1.27mm	29.28	20.32	26.82	8.50
NFP-40A-0132-**	40	1.27mm	33.09	24.13	30.83	8.50
NFP-50A-0132-**	50	1.27mm	39.44	30.48	36.88	8.50
NFP-60A-0132-**	60	1.27mm	45.79	36.83	43.33	8.50
NFP-80A-0132-**	80	1.27mm	58.49	49.53	56.03	8.50



# NFP SERIES

## APPLICABLE DIMENSIONS *(reference only)*

### Connector Outline Dimensions

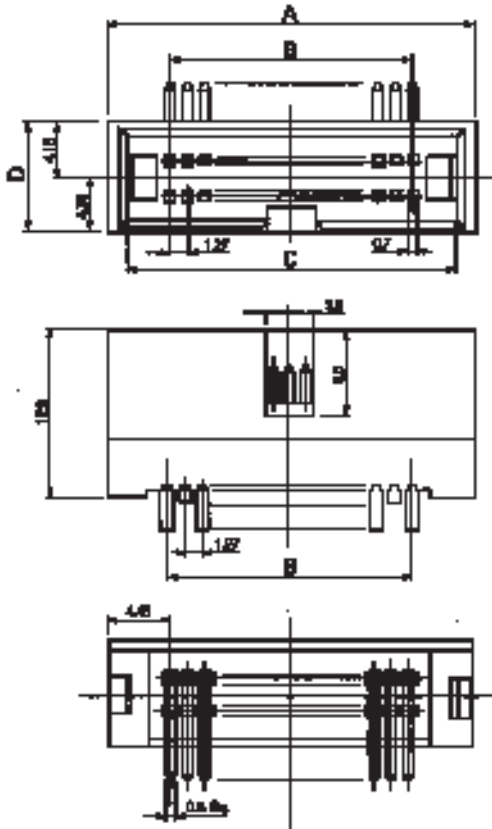

### Contact Detail

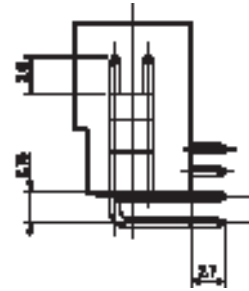

NFP Connectors

### PCB Layout

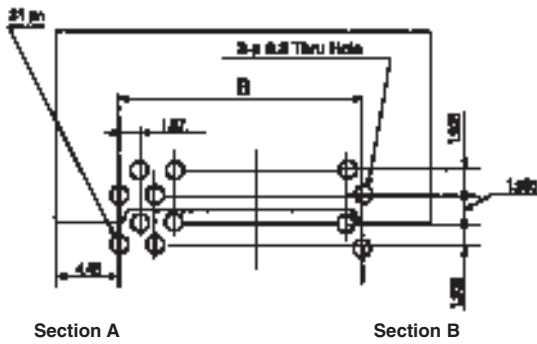

Section A

Section B

26, 34, 50 Contacts



16, 20, 40, 60, 80 Contacts

Note: Left half of this PCB layout is identical to Section A

# Box Header (1.27 mm, Straight Solder Dip)

## NFP SERIES

### ORDERING INFORMATION



NFP- \*\* A-013 4- \*\*

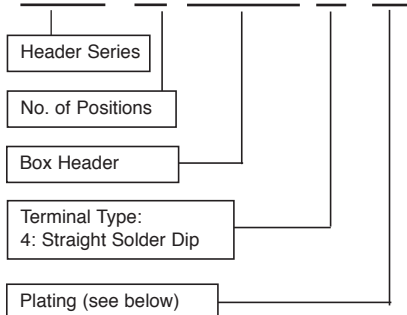

### Characteristics

Current Rating:	0.5A
Insulation Resistance:	1,000M   Minimum at 500 VDC
Withstanding Voltage:	500 VAC for 1 minute
Contact Resistance:	15m   Max. at 10mA
Operating Temperature:	-20°C ~ +85°C

### Material and Finish

Insulator:	High Temp Thermoplastic-UL94V-0
Contact:	Copper Alloy
Plating:	Mating Face Contacts: Au over Ni Terminals: Au or SnPb over Ni

### Features

1. Straight terminals
2. Variety of plating options
3. Central polarizing key

### TYPES OF PLATING

Plating Type	Under Plate	Mating Face	Terminals
AS	Ni 2.5 ~ 4.5 μm	Au 0.76μm Min.	SnPb 2.0 ~ 4.0μm
BS	Ni 2.5 ~ 4.5 μm	Au 0.30μm Min.	SnPb 2.0 ~ 4.0μm

### CONNECTOR DIMENSIONS *(reference only)*

Part Number	No. of Positions	Pitch	A	B	C	D
NFP-16A-0134-**	16	1.27mm	17.85	8.89	15.39	8.50
NFP-20A-0134-**	20	1.27mm	20.39	11.43	17.93	8.50
NFP-26A-0134-**	26	1.27mm	24.20	15.24	21.74	8.50
NFP-34A-0134-**	34	1.27mm	28.28	20.32	26.82	8.50
NFP-40A-0134-**	40	1.27mm	33.09	24.13	30.63	8.50
NFP-50A-0134-**	50	1.27mm	39.44	30.48	36.98	8.50
NFP-60A-0134-**	60	1.27mm	45.79	36.83	43.33	8.50
NFP-80A-0134-**	80	1.27mm	58.49	49.53	56.03	8.50

# NFP SERIES

## APPLICABLE DIMENSIONS *(reference only)*

### Connector Outline Dimensions

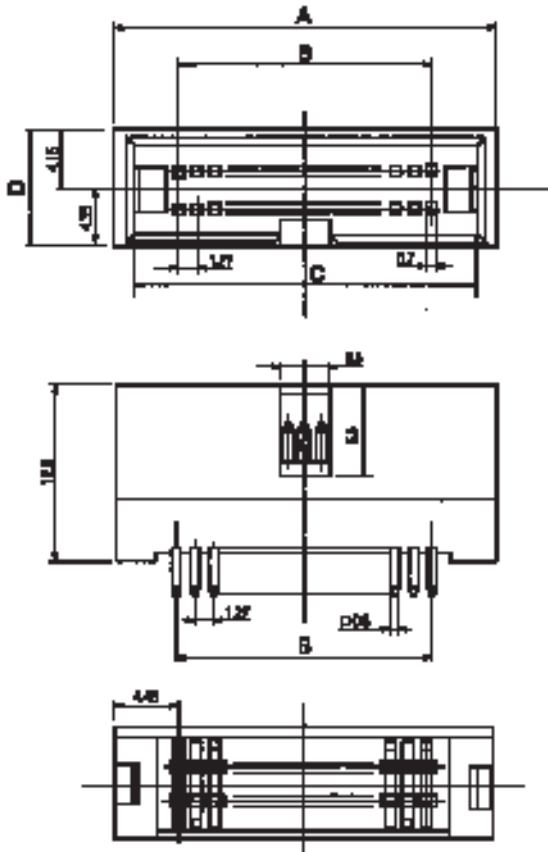

Contact Detail

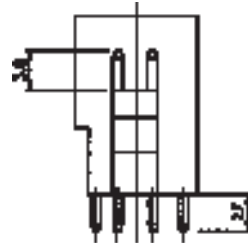

NF Connectors

### PCB Layout

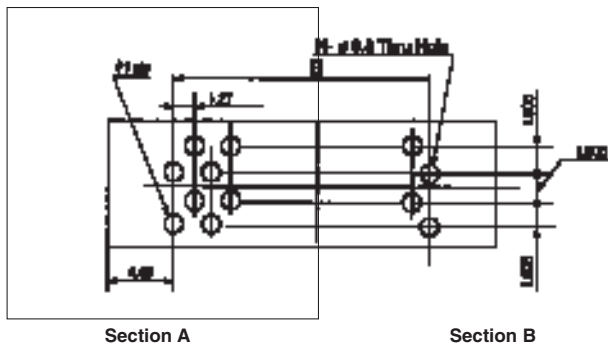

Section A

Section B

26, 34, 50 Contacts

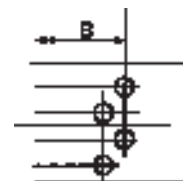

16, 20, 40, 60, 80 Contacts

Note: Left half of this PCB layout is identical to Section A

# IDC Transition Header (1.27 mm)

## NFP SERIES

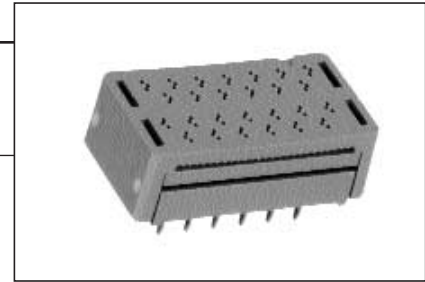

### ORDERING INFORMATION

NFP- \*\*\* G- 0100- \*\*

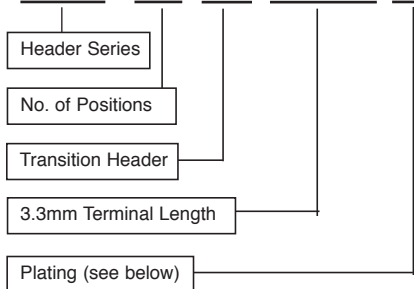

### Characteristics

Current Rating:	1A
Insulation Resistance:	1,000M   Minimum at 500 VDC
Withstanding Voltage:	500 VAC for 1 minute
Contact Resistance:	15m   Max. at 10mA
Operating Temperature:	-20°C ~ +85°C

### Material and Finish

Insulator:	High Temp Thermoplastic-UL94V-0
Contact:	Copper Alloy
Plating:	Mating Face Contacts: Au over Ni Terminals: Au or SnPb over Ni

### Features

1. Unique three-fork IDC contact allows termination of 0.635mm pitch flat cable
2. Various plating options

### APPLICABLE CABLES

- Solid Wire AWG 30
- Stranded Wire AWG 30
- Cable Spacing (0.635mm)

### TYPES OF PLATING

Plating Type	Under Plate	Mating Face	Terminals
BS	Ni 2.5 ~ 4.5 μm	Au 0.30μm Min.	SnPb 2.0 ~ 4.0μm
AF	Ni 2.5 ~ 4.5 μm	Au 0.78μm Min.	Au 0.05μm Min.
BF	Ni 2.5 ~ 4.5 μm	Au 0.30μm Min.	Au 0.05μm Min.

### CONNECTOR DIMENSIONS (reference only)

Part Number	No. of Positions	Pitch	A	B	C	D
NFP-10G-0100-**	10	1.27mm	11.08	5.08	6.95	3.30
NFP-16G-0100-**	16	1.27mm	14.89	8.89	6.95	3.30
NFP-20G-0100-**	20	1.27mm	17.43	11.43	6.95	3.30
NFP-28G-0100-**	28	1.27mm	21.24	15.24	6.95	3.30
NFP-34G-0100-**	34	1.27mm	26.32	20.32	6.95	3.30
NFP-40G-0100-**	40	1.27mm	30.13	24.12	6.95	3.30
NFP-50G-0100-**	50	1.27mm	36.48	30.48	6.95	3.30
NFP-60G-0100-**	60	1.27mm	42.83	36.83	6.95	3.30
NFP-64G-0100-**	64	1.27mm	45.37	39.37	6.95	3.30
NFP-68G-0100-**	68	1.27mm	47.90	41.91	6.95	3.30
NFP-80G-0100-**	80	1.27mm	55.53	49.53	6.95	3.30
NFP-100G-0100-**	100	1.27mm	68.23	62.23	6.95	3.30

# NFP SERIES

**APPLICABLE DIMENSIONS** (reference only)

**Connector Outline Dimensions**

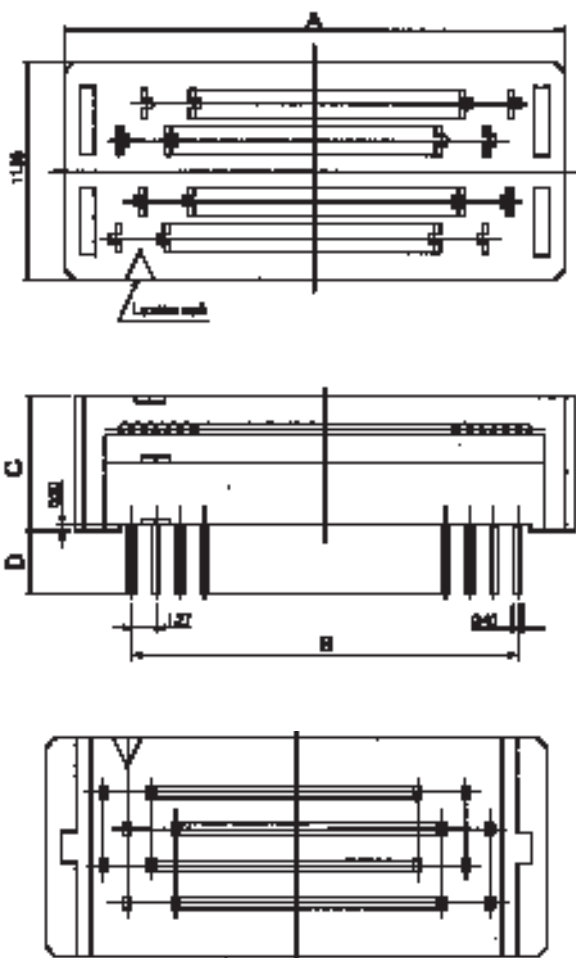

**Contact Detail**

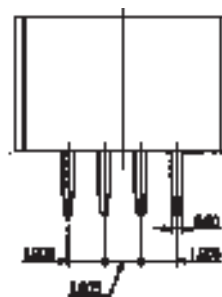

NFP Connectors

**PCB Layout**

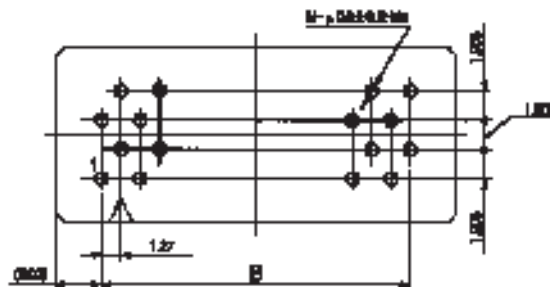

# IDC Receptacle (1.27 mm)

## NFS SERIES

### ORDERING INFORMATION

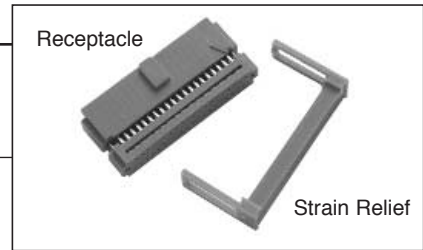

NFS- \*\*\* A-011 \* - \*\*

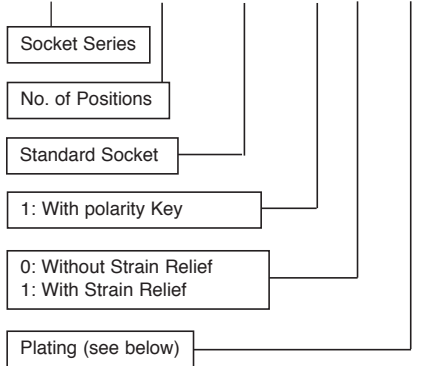

### Characteristics

Current Rating:	1A
Insulation Resistance:	1,000M   Minimum at 500 VDC
Withstanding Voltage:	500 VAC for 1 minute
Contact Resistance:	15m   Max. at 10mA
Operating Temperature:	-20°C ~ +85°C

### Material and Finish

Insulator:	High Temp Thermoplastic-UL94V-0
Contact:	Copper Alloy
Plating:	Mating Face Contacts: Au over Ni Terminals: Au or SnPb over Ni
Accessories	Strain Reliefs (see page 86)

### Features

1. IDC contact allows termination of 0.635mm pitch flat cable
2. Strain relief available to prevent kinking and caving
3. Plating options available
4. Central polarizing key

### APPLICABLE CABLES

- Solid Wire AWG 30
- Stranded Wire AWG 30
- Cable Spacing (0.635mm)

### TYPES OF PLATING

Plating Type	Under Plate	Mating Face	Terminals
AF	Ni 2.5 ~ 4.5 μm	Au 0.78μm Min.	Au 0.05μm Min.
BF	Ni 2.5 ~ 4.5 μm	Au 0.30μm Min.	Au 0.05μm Min.

### CONNECTOR DIMENSIONS (reference only)

Part Number	No. of Positions	Pitch	A	B	C
NFS-10A-01 <sup>AF, BF</sup>	10	1.27mm	11.08	5.08	6.00
NFS-16A-01 <sup>AF, BF</sup>	16	1.27mm	14.89	8.89	6.00
NFS-20A-01 <sup>AF, BF</sup>	20	1.27mm	17.43	11.43	6.00
NFS-26A-01 <sup>AF, BF</sup>	26	1.27mm	21.24	15.24	6.00
NFS-34A-01 <sup>AF, BF</sup>	34	1.27mm	26.32	20.32	6.00
NFS-40A-01 <sup>AF, BF</sup>	40	1.27mm	30.13	24.12	6.00
NFS-50A-01 <sup>AF, BF</sup>	50	1.27mm	36.48	30.48	6.00
NFS-60A-01 <sup>AF, BF</sup>	60	1.27mm	42.83	36.83	6.00
NFS-64A-01 <sup>AF, BF</sup>	64	1.27mm	45.37	39.37	6.00
NFS-80A-01 <sup>AF, BF</sup>	80	1.27mm	55.53	49.53	6.00
NFS-100A-01 <sup>AF, BF</sup>	100	1.27mm	66.23	62.23	6.00

# NFS SERIES

**APPLICABLE DIMENSIONS** (reference only)

**Connector Outline Dimensions**

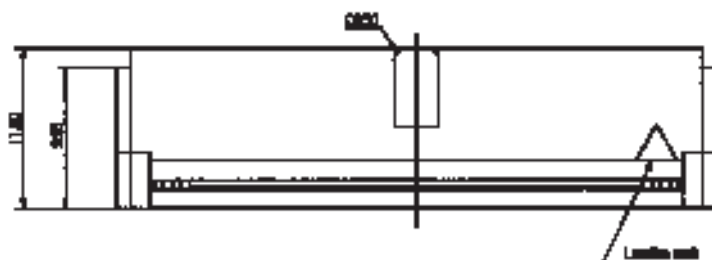
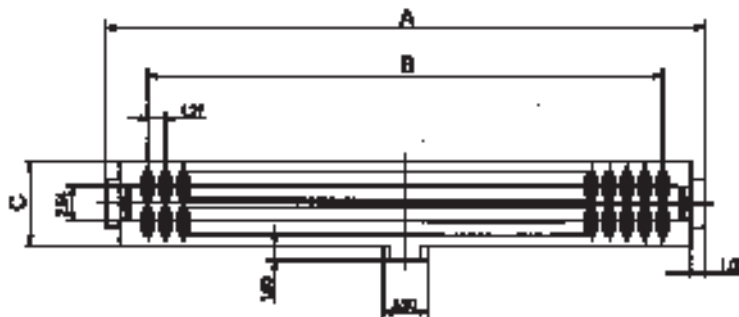

**Contact Detail**

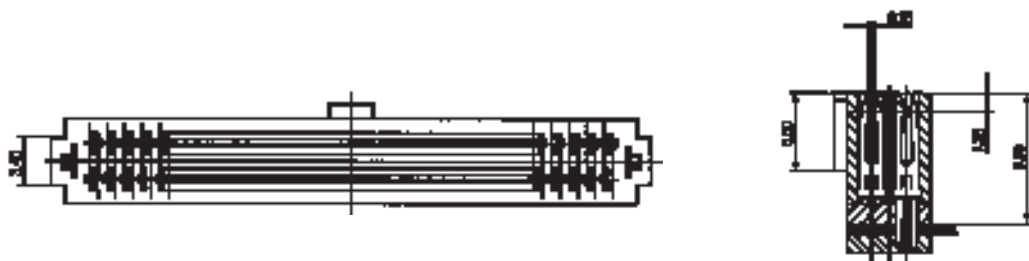

NFS Connectors

# Board to Board Receptacle (1.27 mm)

## NFS SERIES

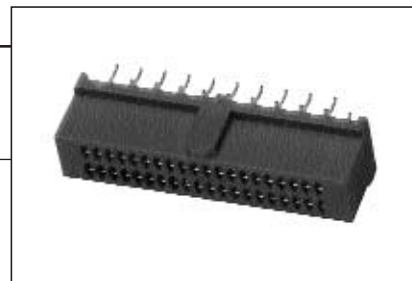

### ORDERING INFORMATION

NFS- \*\* A-131 4- \*\*

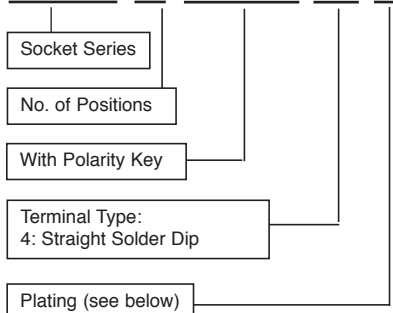

### Characteristics

Current Rating:	1A
Insulation Resistance:	1,000M   Minimum at 500 VDC
Withstanding Voltage:	500 VAC for 1 minute
Contact Resistance:	15m   Max. at 10mA
Operating Temperature:	-20°C ~ +85°C

### Material and Finish

Insulator:	High Temp Thermoplastic-UL94V-0
Contact:	Copper Alloy
Plating:	Mating Face Contacts: Au over Ni Terminals: Au or SnPb over Ni

### Features

1. Straight terminals
2. Terminal length (2.7mm)

### TYPES OF PLATING

Plating Type	Under Plate	Mating Face	Terminals
BS	Ni 2.5 ~ 4.5 µm	Au 0.30µm Min.	SnPb 2.0 ~ 4.0µm

### CONNECTOR DIMENSIONS (reference only)

Part Number	No. of Positions	Pitch	A	B	C
NFS-40A-1314**	40	1.27mm	30.13	24.12	8.00
NFS-50A-1314**	50	1.27mm	38.48	30.48	8.00
NFS-60A-1314**	60	1.27mm	42.83	36.83	8.00
NFS-64A-1314**	64	1.27mm	45.37	39.37	8.00
NFS-80A-1314**	80	1.27mm	55.53	49.53	8.00



# NFS SERIES

**APPLICABLE DIMENSIONS** (reference only)

**Connector Outline Dimensions**

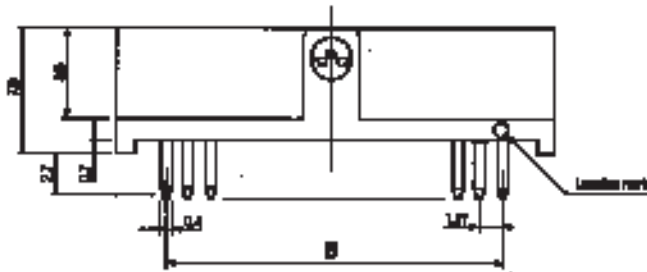
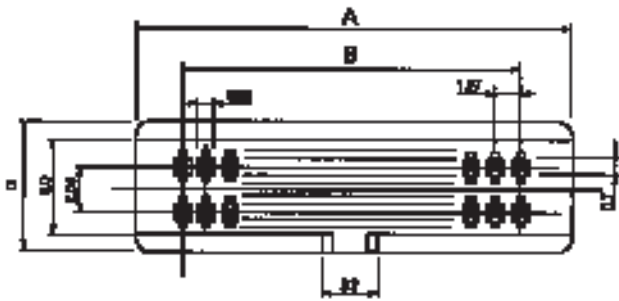

**Contact Detail**

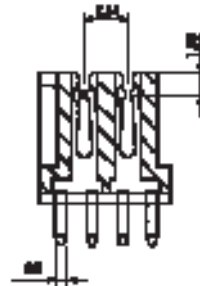

**PCB Layout**

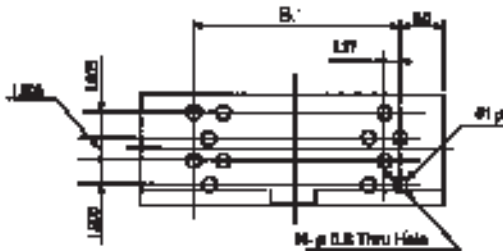

NFS Connectors

## X-ON Electronics

Largest Supplier of Electrical and Electronic Components

*Click to view similar products for [FFC & FPC Connectors](#) category:*

*Click to view products by [Yamaichi](#) manufacturer:*

Other Similar products are found below :

[HFW11R-1STE1H1LF](#) [FH29B-100S-0.2SHW\(99\)](#) [FA5S008HP1](#) [FH29B-120S-0.2SHW\(99\)](#) [FH29B-80S-0.2SHW\(99\)](#) [FHS-16](#) [FPH-2022G](#)  
[52610-1075](#) [52610-1275](#) [52610-1934](#) [XF3M\(1\)-1415-1B-R100](#) [501864-3091-TR225](#) [0525594033](#) [086210010340800](#) [086222026001800](#)  
[52271-2869-CUT-TAPE](#) [62674-201121DLF](#) [62684-36210E9ALF](#) [52610-1675](#) [52746-1671-TR250](#) [10051922-2810EHLF](#) [6-520415-9](#)  
[BD021-09A-A1-0350-0200-0550-LD](#) [SFV6R-1STE9HLF](#) [XF3M-2915-1B-R100](#) [1658549-1](#) [62674-221121ALF](#) [46214008010800](#)  
[046298003000883](#) [151660622](#) [842-816-2630-035](#) [AYF530665TA](#) [AYF351525](#) [046296011930846+](#) [AYF352325A](#) [046254020000800+](#)  
[FH19C-13S-0.5SH\(99\)](#) [FH39J-51S-0.3SHW\(99\)](#) [AYF355125A](#) [AYF530365TA](#) [FH29B-44S-0.2SHW\(99\)](#) [SFW5R-2STAE9LF](#) [AYF351125A](#)  
[AYF350725A](#) [62684-502100AHLF](#) [FH39-61S-0.3SHW\(99\)](#) [AYF414035A](#) [10064555-172520HLF](#) [AYF212335A](#) [504754-2500](#)